

*

UMASS/AMHERST

*



312066 0333 2883 6

LIBRARY
OF THE



MASSACHUSETTS
AGRICULTURAL
COLLEGE

NO. 608 DATE 7-1885

SOURCE Hills fund

Per.

[REDACTED] .8

WITNES

This book may be kept out

TWO WEEKS

only, and is subject to a fine of TWO
CENTS a day thereafter. It will be due on
the day indicated below.

FEB 15 1932

THE
GARDENER'S MAGAZINE,



CONDUCTED

By J. C. LOUDON, F.L.S. H.S. &c.

AUTHOR OF THE ENCYCLOPEDIAS OF GARDENING AND OF AGRICULTURE, AND
EDITOR OF THE ENCYCLOPEDIA OF PLANTS.

LONDON:

PRINTED FOR

LONGMAN, REES, ORME, BROWN, GREEN, AND LONGMAN,
PATERNOSTER-ROW.

1832.

Per
G 168 v. 8

LONDON :
Printed by A. & R. Spottiswoode,
New-Street-Square.

PREFACE.

THE contents of this Eighth Volume of the Gardener's Magazine show that the work continues to answer the purposes for which it was commenced, viz. those of collecting scattered fragments of information on the various departments of gardening on which it treats; giving an account of the progress which the art is making in various parts of the world, and more especially in Britain; and bringing minds into collision, which, probably, would not otherwise have known of each other's existence.

The grand characteristics of the present times are union and cooperation for general improvement. Those engaged in arts and occupations which admit of their congregating together in towns feel no difficulty in assembling, and communicating their different discoveries and wants: hence the advantages which are daily resulting from scientific societies and mechanics' institutions. The gardener and the farmer, however, have but slender opportunities of improving themselves, or benefiting others, by attendance at such associations; and must necessarily be, in a great measure, precluded from the advantages which result from belonging to them. The principal medium of communication of all such persons is, therefore, the press; and the probability is, that, with the progress of human improvement, every description of rural art or trade (if not all arts and trades whatever) will have its own particular Newspaper or Magazine. The idea has been already suggested in the *Scotsman* newspaper, and in the *New Monthly Magazine*. It is in consequence of the want of personal intercourse, or the means of communication through the press, that the country population are, in intelligence and enterprise, comparatively behind those whose pursuits admit of their residing in towns; and, of all classes of country residents, agricultural labourers are generally the most deficient in moral and intellectual improvement. The cause is, that no other class is so completely isolated from the rest of society. Till lately, this has been, to a considerable degree, also the case with gardeners: and

hence the necessity and advantage of their having magazines especially devoted to their professional pursuits and social interests. A Magazine for the common country labourer remains a desideratum; but, though no class of society would be more benefited by such a medium of communication, the time does not seem yet arrived for producing it.

Gardeners, from the nature of their profession, and from coming more in contact with cultivated minds and with books, have always been in advance of the working farmer and common country labourer; but their progress, since the general establishment of horticultural societies, and of a Magazine expressly devoted to the advancement of their art and their personal interest, has been greatly accelerated; and this improvement, we have no doubt, will continue to increase far beyond what the most sanguine of us can at present anticipate.

We have left ourselves too little room to point out all those parts of the present Volume which, in a more especial manner, deserve attention; but we cannot help noticing the circumstance of its containing a number of well written articles by young journeymen gardeners, in different parts of the country; who, having begun life with very little education, and without ever having had higher wages than 10s. or 12s. a week, owe their improvement entirely to their own exertions, to which they have been chiefly stimulated by the perusal of this Magazine. It also gives us pleasure to observe, by the contents of this Volume, that an increased attention has been paid to gardening, as an art of design and taste, by various of our contributors. The best cultivator of fruits and vegetables that ever existed is, in our eyes, unfit for the care of a gentleman's garden, if he be without a taste for order and neatness, and for that species of beauty in garden scenery which we have elsewhere (p. 701.) shown might be appropriately denominated the gardenesque.

J. C. L.

Baywater, Nov. 21. 1832.

CORRECTIONS.

<p>Errors are corrected in the first occurrence of the head "Retrospective Criticism," after they have been observed: in the present volume see pp. 244. 367. 607. Besides these, the following errors require correcting:—</p>	<p>In p. 174. for "Longleat" read "Shortgrove, Essex." In p. 255. line 33. for "1831" read "1832." In p. 483. line 3. from the bottom, for "Vol. V111." read "Vol. V11."</p>
---	--

CONTENTS.

ORIGINAL COMMUNICATIONS.

GENERAL SUBJECT.

General Results of a Gardening Tour, during July, August, and part of September, in the Year 1831, from Dumfries, by Kirkcudbright, Ayr, and Greenock, to Paisley. By the Conductor	- 1. 129. 257. 385. 513
Hints on raising the Leguminous Plants of Australia and the Cape of Good Hope from Seeds, on acclimatising them in Europe, and on their native Habits. By Mr. J. Bowie	5
Remarks on the depressed State of the Nursery and Gardening Professions, more especially in Scotland. By J. G.	- 134
On the Necessity for increased Exertion on the part of young Gardeners to store their Minds with professional and general Knowledge. By Scientiæ et Justitiæ Amator	- 137
On Gardening Recreations as a Substitute for Fox-hunting, Horse-racing, and other brutalising Sports. By Mr. Thos. Clark, Jun.	140
On the Sap-vessels, or Circulating System, of Plants. By the Author of "The Domestic Gardener's Manual," C.M.H.S.	- 142
Observations made on the Performance of a Hot-water Apparatus in a Pinery at the Earl of Egremont's, Petworth, Sussex, during the severe Weather in January last, by Mr. Harrison, the Gardener there. Communicated by Mr. Cottam	- 147
Various Recipes for destroying Insects, restoring the Bark of Trees, preparing Compost for Pines, &c. By Mr. Peter Martin, Foreman in the Nursery of Messrs. Murray and Coss, near Leeds	- 148
Horticultural Notes on a Journey from Rome to Naples, March 1—6. 1832. By Wm. Spence, Esq. F.L.S.	- 266
Some Account of the Nursery Gardens and the State of Horticulture in the Neighbourhood of Philadelphia, with Remarks on the Subject of the Emigration of British Gardeners to the United States. By Mr. Wm. Wynne, Foreman in Bartram's Botanic Garden, Philadelphia	- 272
Notices of some of the principal Nurseries and private Gardens in the United States of America, made during a Tour through the Country, in the Summer of 1831; with some Hints on Emigration. By Mr. Alexander Gordon	- 277
On certain Frauds imposed by Correspondents upon the Readers of Transactions of Horticultural Societies, and of the Gardener's Magazine, &c. By An Enemy to Deceit	- 289
Plan for heating Hot-houses by the Circulation of hot Water in hermetically sealed Tubes of small Diameter. By Mr. A. M. Perkins	- 292
A new Trap for catching Moles, with some Remarks illustrative of its Superiority over the Traps now generally in Use. By A. F.	- 298
Extracts from Notes made during a Horticultural Tour in the Netherlands, and Part of France, in June and July, 1830. By Mr. T. Rivers, Jun.	- 392
Investigation of the Structure of the Balsam (<i>Balsamina hortensis Desportes</i>). By the Author of the "Domestic Gardener's Manual"	403
Horticultural Jottanda of a recent Continental Tour. By Robert Mallet, Jun. Esq.	- 521
Remarks on certain Gardens in the Lake District, and on cultivating a Taste for Gardening among Cottagers generally. By Joshua Major, Esq., Landscape-Gardener	- 527
On Gardens for the labouring Poor. By Selim	529
On the Means of inspiring a Taste for Gardening among the labouring Classes of Scotland. By James Stuart Menleath, Jun. Esq., of Closeburn, Dumfriesshire	- 532
On the Construction of Double-roofed Hot-houses at Vienna. By M. Charles Rauch, Court-Gardener at Laxenburg	- 535
A new Mode of training Fruit Trees; a new Mode of grafting and inarching; and an improved Mode of making Gooseberry Wine and Cider, &c. By Mr. W. Green, Jun.	- 539
Observations on several Gardens in England. By Mr. W. Sanders	- 546
Design for a Gardener's House, containing Five Rooms and an Office; adapted for being connected with the Wall of a Kitchen-Garden	551
Notice of some new Cast-iron Flower-Stakes, and some small Wrought-Iron Stakes for Peas or Annuals, invented by Robert Mallet, Jun. Esq. Communicated by Mr. Mallet	- 554
Notice of the Cast-iron and Wrought-Iron Flower-Stakes manufactured by Cottam and Hallen, London. By the Conductor	- 556
Notice of a newly invented Hoe. By John Booker, Esq.	- 558
Remarks relative to the Advice given by Mr. Mallet to young Gardeners. By Scientiæ et Justitiæ Amator	- 641
The Necessity, and Advantages of Gardeners visiting one another's Gardens. By R. T.	645
Directive Hints for the effective Cultivation of Cottage Gardens. By Selim	- 647
On the Influence of Cottage Gardens in promoting Industry and Independence among Cottagers. By John H. Moggridge, Esq.	650
A Question to the Author of "The Domestic Gardener's Manual." By Mr. Main	- 652
On Mr. Hayward's Mode of training Peach Trees, as compared with Mr. Geymour's Mode. By Joseph Hayward, Esq.	- 653
On the Application of the Ammoniacal Liquor of Coal Gas to the Destruction of Insects and Vermin. By Robert Mallet, Esq.	- 656
Design for a Gardener's House, adapted for being connected with the West Wall of a Kitchen-Garden	- 659
Design for a Gardener's House, serving, at the same time, as a Watchtower for the Fruit Walls of a Garden in the Neighbourhood of a large City. By T. A.	- 660
Designs and Details for opening the Gates of Lodges to Gentlemen's Seats in the Night-time, without troubling the Gate-keeper to leave his Bed. By Mr. Saul	- 662
A Description of Two Kinds of Beehive. By Mr. W. Young	- 664
Notice of a new Transplanting Instrument for Florist's Flowers, invented by Capt. Hurdis, R.N. Communicated by Mr. Cameron, Nurseryman at Uckfield, Sussex	- 666
Description of an Instrument for Use in the Summer Pruning of Forest Trees. By Mr. William Taylor, Gardener, Thainston, Aberdeenshire	- 668
A Description of a useful Garden Implement termed Parallel Rods, designed for marking Parallel Lines on Beds. By its Inventor, Mr. William Godshall	- 669
LANDSCAPE-GARDENING AND GARDEN ARCHITECTURE.	
On certain Defects in Pleasure-Grounds, and the Mode of avoiding them. By Mr. Robert Errington	- 151
On planting and laying out Grounds. By M. Herman Knoop Klinton, Landscape-Gardener, Ghent	- 301
Description of a Design made for the Birmingham Horticultural Society, for laying out a Botanical Horticultural Garden, adapted to a particular Situation. By the Conductor	407
A Plan and Description of the Flued Walls in the Gardens of Erskine House, with a Plan	

- and Description of the Kitchen-Garden. By Mr. G. Shiells - 470
- Remarks on the Question, Whether the Architect or Landscape-Gardener should be first employed in the Formation of a Residence. By Mr. James Mann, A.L.S. &c. - 673
- ARBORICULTURE.**
- An Account of the Common and Highland Pines, as found in Scotland. By J. G. - 10
- Notices of large Trees in the United States and in Canada. Communicated by James Mease, Esq. M.D., of Philadelphia - 152
- Description of a Tree-Guard in Use at Thainston, in Aberdeenshire. By W. Taylor, Gardener, &c., to D. Forbes Mitchell, Esq., of Thainston - 154
- On pruning Forest Trees. From "Essays on Vegetable Physiology" preparing for the Press. By J. Main, A.L.S. - 303
- On Transplanting large Trees, Pruning, &c. By Mr. Howden - 559
- FLORICULTURE.**
- Design for a Flower-Garden, intended for a particular Situation near an old Mansion, with a List of Plants for Summer Display. The Plan by C. D., and the List by Mr. George Wood, Gardener to Thomas Hope, Esq., M.P., of Depedene, Surrey - 155
- On the Culture of Nelumbiums. By C. - 157
- On the Cultivation of *Brugmansia arborea* [saxibolens] in a Conservatory. By Mr. Jas. Arnold, Gardener at Grove House, Cheshnut - 159
- On the Propagation and Culture of *Polygala cordifolia*, *Eutaxia myrtifolia*, and *Phenacoma prolifera*. By Mr. J. Nicollis, Gardener to R. Pettward, Esq., Finborough Hall, Suffolk - 160
- A Method of cultivating Pelargoniums, as practised at Horsforth Hall Gardens. By Mr. Thos. Appleby - 161
- On the Culture of Pelargoniums. By Robert Elliot, Gardener to William Hartley, Esq., Rose Hill, near Whitehaven - 162
- On the History and Culture of the Carnation. By Edward Hudge, Esq. F.R.S. F.S.A. and F.L.S., President of the Vale of Evesham Horticultural Society. Read at the Meeting of the Society, July 24. 1828 - 428
- Remarks on laying out and managing Flower-Gardens. By Mr. Robert Errington - 562
- List of Exotics which are now living in the Gardens of Charles Hoare, Esq., at Luscombe, near Dawlish, in Devonshire. Communicated by Mr. Richd. Saunders, Gardener and Planter there - 566
- List of certain Green-house and Hot-house Plants which have stood out during one or more Winters, in the open Air, in the Garden of Robert Mallet, Esq., at Drumcondra, near Dublin. Communicated by Mr. Mallet, Jun. - 568
- On sowing annual Flower Seeds in the Autumn, in order to have them flower early in the Spring. By R. T. - 570
- On the Culture of the Ranunculus. By a Village Schoolmaster - 570
- On the Cultivation of *Ranunculus parnassifolius* and *Oxalis floribunda*. By Mr. John Menzies, Gardener to Christopher Rawson, Esq., Hope House, near Halifax - 572
- On the Culture of the Heartsease Violet. By Mr. Arch. Gorrie, F.H.S. and C.H.S. &c. - 573
- A Fence for Plantations about Pasture Grounds in sight from a Residence, and Stakes for Standard Roses. By Chas. Lawrence, Esq. - 677
- A Description of a Method of propagating Cape Heaths expeditiously. By Mr. T. Rutger - 681
- On the Cultivation of the *Droseras* and *Pinguiculas*. By Robert Mallet, Esq. - 684
- HORTICULTURE.**
- A Descriptive List of such Apples as have been found to succeed in the Neighbourhood of Kilkenny, in Ireland. By Mr. John Robertson, F.H.S., Nurseryman there - 165
- On a Method of forcing Cabbage Lettuce, practised for many Years at Longleat, by the late Mr. Rutger, Gardener there. Communicated by his son, Mr. T. Rutger - 172
- On a Mode of cultivating the Tomato, so as to make sure of ripening the Fruit without artificial Heat. By E. S. - 174
- On the Culture of Mushrooms in Melon Beds. By Mr. John Collier, Gardener to Edmund Woods, Esq., Shopwick - 312
- On the Culture of the Pine-apple without Pots. By Mr. James Mitchinson, Gardener at Pendarves - 576
- On a rapid Mode of raising excellent Vine Plants. By Mr. T. Rutger, Gardener at Short Grove, Essex - 577
- On substituting good Vines, either as to Kind or State of Health, for bad ones, with the least possible Loss of Time. By Mr. Alexander Gordon, late Gardener to Sir F. G. Fowke, Bart., Lowesby Hall, Leicestershire - 578
- On the Destruction of the *Aphis* on Peach and Nectarine Trees. By Mr. G. Jamieson, late Gardener to Mrs. Bulwer Lytton, of Knebworth Park, Herts - 580
- Account of a Method of gathering Apples from the most lofty and slender Trees, without breaking any Twigs, and without Danger to the Operator. By Mr. E. M. Mather - 581
- On the Fruits used in the Manufacture of Perry and Cider. By J. C. K. - 582
- On Bishop's Dwarf Pea, as compared with other early Peas. By Mr. Anthony Adamson, in a Letter to Mr. John Gibson. Communicated by Mr. Gibson - 584
- An Account of the Otaheitan Method of preparing the Arrow-root. By Andrew Mathews, Esq., of Lima - 585
- Description of the Petre Pear, a fine Seedling Butter Pear, cultivated in the Bartram Botanic Garden, near Philadelphia. By Colonel Robert Carr, Proprietor of that Garden - 587
- On procuring Two Crops of the Ash-leaved Kidney Potato, in One Year, off the same Ground. By John Denson, Sen. - 688
- Abridged Communications - 175. 314. 589. 688

REVIEWS.

- Transactions of the Horticultural Society of London. Second Series. Vol. I. Part I. 177. 315. 433
- Memoirs of the Caledonian Horticultural Society. Vol. IV. Part II., and Vol. V Part I. 178. 322. 439
- Verhandlungen des Vereins zur Beförderung des Gartenbaues in den Königlich Preussischen Staaten. Transactions of the Society for the Advancement of Gardening in the Royal Prussian States - 187. 338. 442
- Catalogue of Works on Gardening, Agriculture, Botany, Rural Architecture, &c., lately published, with some Account of those considered the most interesting - 198. 341. 452. 698
- Literary Notices - 221. 345. 463. 698

MISCELLANEOUS INTELLIGENCE.

- Notices of new Plants, or of interesting old ones, derived from the British monthly Botanical Periodicals for February and March, 1832 224
- Floricultural and Botanical Notices of new Plants, and of old Plants of Interest, supplementary to the latest Editions of the "Encyclopædia of Plants," and of the "Hortus Britannicus" - 345. 454. 596. 721
- Notices of Plants recently imported, figured, or described; and such Notices of old Inhabit-

ants of our Gardens as may be likely to inter-	A Walk, on the 30th of June, round the Garden
est the Cultivator or Amateur - 12	of the late Comtesse de Vandes. By J. D. 476
General Notices - - - 26. 236. 353. 464	Metropolitan Nurseries - - - 101. 249
Foreign Notices - - - - 62. 356	Provincial Nurseries - - - 104. 251. 741
Domestic Notices - - 79. 243. 361. 470. 593	Provincial Horticultural Societies - 115. 251.
Hints for Improvements - - - 81. 366	626. 745
Retrospective Criticism 83. 244. 367. 482. 607. 728	London Horticultural Society and Garden 125.
Queries and Answers - 90. 372. 499. 609. 735	252. 378. 505. 614. 742
Cottages and Cottage Gardens, Workhouse	Covent Garden Market - 127. 254. 383. 504. 624.
Gardens, and Gardens of Prisons and Lunatic	744
Asylums - - - - - 96. 376.	Obituary - - - - - 255. 384. 751
Index to Books reviewed and noticed - - - 752	
General Index - - - - - 753	

LIST OF ENGRAVINGS.

No.	Page	No.	Page
		STRUCTURES.	
115. Booker's newly invented hoe - 558		55. Ground plan, and 56. and 57. Section	
INSTRUMENTS.		of a set of pits for melons, pine-apples,	
121. Apparatus for exploding blasts in sink-		or other hot-house plants: erected at	
ing wells in rocks - - - - - 591		Colonel Paterson's, Cunnockholm 332, 333	
62. A detached fumigator to fit any bellows	354	33. Ground-plan of a house, with bath	
122. A glass siphon with a glass globe to		and conservatory attached, and to be	
concentrate the sun's rays - - 610		heated by one boiler - - - 90	
8, 9. Improved numbering sticks on the		42. Ornamental fountain in artificial stone, 237	
notch principle - - - - - 32		139. Plan for a rustic beehive - - - 665	
79, 80, 81. A Lapland lock made of wood - 468		31. Telford's iron gate, of flat bar iron - 85	
6, 7. Mr. Neeve's instrument for laying		20. Sketch of a light for a hot-bed - 40	
off or transferring angles - - - 31		84, 85, 86, 87. A double-roofed hot-house at	
49. Plug, trigger, or mumbering-peg to Mr.		Vicuna - - - - - 536, 537, 538	
Neeve's instrument - - - - - 299		54. Section of a glazed house adapted for	
142. Parallel rods for apportioning the space		the culture of peach trees, grape vines,	
of beds - - - - - 669		and ornamental plants - - - 329	
61. Siebe's universal garden syringe - 354		ARBORICULTURE.	
141. Shears for use in pruning forest trees		36. A tree-guard in use at Thainston - 154	
in summer - - - - - 668		EDIFICES.	
58. Thermometer indicating the heat of		35. Ballyscullion House, Ireland - - 91	
the soil and air at once - - - 337		64, 65. Public water-closets - - - 389	
47, 48. Two views of a newly invented		105, 106, 107. Designs for chimneys - 553, 554	
moletrap - - - - - 299		66, 67, 68. Designs for chimneys - - 390	
10, 11, 12. Various forms for brick tallies	33	104. A gardener's house, connected with the	
59, 60. Warner's syringe - - - 353		wall of a kitchen-garden - - - 552	
UTENSILS.		130. Ground-plan, and plan of chamber - 660	
17. Annular pan to insulate plants from		131, 132. Gardener's house, to serve also as	
the access of insects - - - - 37		a watchtower - - - - - 661, 662	
16. French moletrap - - - - - 36		129. Gardener's house connected with the	
140. Hurdis's flower transplanter - - 667		west wall of a kitchen-garden - 659	
126, 127, 128. Implements for the application		FRUIT.	
of the ammoniacal liquor of coal gas	657	120. Outline of the Petre pear, a butter pear 588	
	658	PLANS OF GARDENS.	
39. Still for manufacturing various liqueurs	183	69. Brussels botanic garden, plan of	
117. A pot for protecting plants grown in it		elevations and plans of the glass-	
from snails and slugs - - - - - 572		houses in - - - - - 402	
77,* 78.* A tub for measuring and weigh-		40. Arrangement of the public garden at	
ing corn - - - - - 467		Magdeburg - - - - - 192. 193	
22. Tulip transplanter, as improved by		71. to 78. Proposed plan, sections, &c., for	
Mr. Saul - - - - - 44		the Birmingham botanic garden 410-425	
23. Tulip transplanter, the old kind - 44		37. Design for a garden near an old man-	
MACHINES.		sion - - - - - 156	
13, 14, 15. Budding's machine for shearing		143. The flued walls at Erskine House, Ren-	
grass plots, &c. - - - - - 34		frewshire - - - - - 671	
98, 99. Mill for crushing soft fruit - - 542		102. Kitchen-garden at Longford Castle - 549	
100, 101. A more powerful press for similar		144. Plan of the kitchen-garden at Erskine	
purposes - - - - - 541, 545		House - - - - - 672	
171. Jesse's apparatus for transplanting trees		103. Pleasure-grounds at Longford Castle - 550	
and large shrubs - - - - - 732		116. Errington's plan for a flower-garden 564, 565	
133, 134, 135, 136, 137, 138. Design and de-		29. Parmentier's garden, Brooklyn, Long	
tails of an apparatus for opening lodge		Island, North America - - - - 71	
gates in the night, while remaining in		45. A residence wrongly placed in a park - 675	
the bed-room - - - - - 663, 664		120. The Tivoli garden at Vienna - - - 67	
43. Norman wheelbarrow - - - - - 238		PLANTS.	
APPARATUS FOR HEATING WITH		25. Form of the yellow Swedish turnip	
HOT WATER.		(Ruta бага) - - - - - 57	
2, 3, 4, 5. Neeve's boiler furnace - 28, 29		26. Form of an improved variety of it - 58	
45, 46. Perkins's distributing pipes - 295, 297		41. <i>T. ris tuberosa</i> L. - - - - - 235	
44. Section and ground plan of Mr. Per-		152. A variety of <i>Quercus Rôbur</i> having	
kins's boiler - - - - - 294		narrow and entire leaves - - - 739	
1. Section of a double-walled boiler - 28		149, 150. Structure of the <i>Rafflesia Arnóidii</i> 708	
		38. <i>Nectámbium speciosum</i> W. - - - 158	

No.	DIAGRAMS.	Page	No.	Modes of engraving by approach	Page
50, 51, 52, 53.	Diagrams illustrative of the effects on timber of variously-timed pruning	310	91, 92, 93, 94, 95, 96, 97.	Modes of engraving by approach	540
63.	Train of wheels ranged along the slope of a hill near Greenock	385	MISCELLANEOUS ARTICLES.		
82, 83.	Sap-vessels and circulation of the sap in <i>Châra</i>	483	119.	Application of a ladder to gathering fruit, without its resting on the tree	581
32.	Sketch of a walk needlessly serpentine	87	24.	A cheap awning for beds of tulips, ranunculuses, &c.	45
OPERATIONS.					
125.	Diagram exhibiting Hayward's mode of training on one stem	655	27.	Diagram of a proposed substitute for hop-poles	65
123.	Diagram illustrative of Hayward's system of training the peach tree	654	18.	Gauntlets for lady gardeners	37
124.	Diagram illustrating Seymour's mode of training the peach tree	654	19.	Howden's gate-shutting hinge	38
21.	Diagram representing Mr. Saul's mode of shifting potted plants	44	34.	Pedestal of a sundial	91
88, 89, 90.	Modes of training	339, 340	108, 109.	Cast-iron stakes and hurdles for flowers	555
118.	A mode of speedily occupying a house with vines	579	110. to [114.	Cast-iron and wrought-iron stakes for supporting flowering plants	557
			30.	Section of an artificially-formed aquarium	84
			146, 147.	Stakes for standard rose trees	679
			143.	Sketch illustrative of a mode of training standard rose trees	680

LIST OF CONTRIBUTORS.

- A Constant Reader, 688. A Correspondent, 611. Adamson, Anthony, 584. A Disappointed Lancashire Farmer, 609. A. F., 248. A Friend, 86. A Friend to the Cottager, 697. A Friend to Enquiry, 372. A Journeyman Gardener, 729. A Lover of Accuracy, 375. A Lover of Horticulture, Hammersmith, 40. Alpha, 103. A. N., 492, 500, 613. An Advocate for every Thing's being done above Board, 730. An Enemy to Bribery, 499. An Enemy to Deceit, 289. An Englishman, 474. 596. A Northumbrian, 90. A Porer, 367. Appleby, Thomas, 161. 491. A Reader of the Gardener's Magazine at Caen, 358. Arnold, James, 159. Arthur, Robert, 56. A Single Gentleman, 343. A Single Tree, 87. A Traveller, 503. Author of "The Domestic Gardener's Manual," 142, 403. A Village Schoolmaster, 570. A. X., 367, 611, 612.
- B. 63. Baron, Charles, 373. B. B., 52, 53, 55, 56. Coventry, 89, 94, 489, 502. Blair, T., 488. Booker, John, 558. Bowie, J., A.L.S., Cape of Good Hope, 5. Boyce, William, 92, 94. B. P., 360. Brassica, 56. Bree, Rev. W. T., A. M., 55, 93, 94, 469, 499, 610, 741.
- C., 157. Callow, Edward, 244. Cameron, J., 666. Carr, Robert, 587. Causidicus, 96. C. D., 155. Checks, Alexander, 738. Clark, Thos., jun., 140. C. L. B., 32. Collier, John, 312. Cottan, George, 147. C. P., 38. C. R., 67. C. T. W., 368. Cymro, 90.
- Denson, J., sen., 79, 101, 686. Dutton, H., 86. E., 83, 368, 610, 694. Elles, J., 81, 94, 215, 220. Elliot, Robert, 162. Errington, Robert, 151. 562. Ephraïmus Horticultor, 57. E. S., 42, 174. E. S., Sittingbourn, 40. E. W., jun., 469. F., 87.
- G., Perthshire, 211. G. C. Marsham, 50. G. J. T., 407. G. M., 239, 476. Godshall, W., 669, 733, 735. Gordon, Alexander, 277, 578. Gorrie, Archibald, F.H.S. and C.H.S., &c., 573. G. R., 360. Green, W., jun., 539. Grierson, William, 91. Groom, H., 46.
- H., 377. H. B., 691. Hamilton, Wm., M.D., 47, 80, 96, 211, 242, 735, 736. Hart, James, 685. Hayercroft, John, 40. Hayward, Joseph, 486, 653. Hertz, W., 358. Hislop, J., 371, 737. Hobson, Wm., 94. Howden, John, 38, 249, 370, 559. Huish, Robert, 376.
- I. J., 736. J., 593. J. C., 741. J. W., New York, 92. Jamieson, G., 580. J. C. K., 55, 582, 613. J. G., 11, 134. J. H. M., 373. J. M., Chelsea, 52, 256, 498, 705. J. M., Lisieux, 66, 228. J. M., Philadelphia, 85. J. S., St. J. S. M., 373. J. W. L., 53, 251, 374, 382. J. W. S., New York, 72.
- Klinton, Herman Knoop, 300. Knight, Joseph, 595.
- Lawrence, Charles, 677, 696. Lawrence, John Robert, 372.
- M., 501. MacLaggan, John, 92. Main, J., A.L.S., 303, 490, 652, 673. Major, Joshua, 527. Mallet, Robert, jun., 85, 364, 370, 482, 521, 554, 568, 592, 610, 656, 684, 697. Manetti, Luigi, 70, 498, 500. Marnock, Robert, 608, 731. Martin, Peter, 148, 361, 570. Mather, E. M., 581. Mattheus Sylvaticus, 46. Mattheus, William, 80. Mease, James, M.D., 85, 152. Menteath, James Stuart, jun., 532. Menzies, John, 572. Merrick, A., 26. Merrick, J., 738. Mitchell, John, 470. Mitchinson, Jas., 576. Moggridge, John H., 65, 357, 650. Mulholland, Hugh, 473. Murray, J., 53, 89. Murphy, E., 369, 370, 371, 372, 503.
- Neeve, D. D., 29. Nicolles, J., 160. Oliver, J., C.M.H.S., 612.
- Pearson, Wm., 734. Penny, George, A.L.S., 50, 103. Perkins, A.M., 293. Perrin, William, 89. Pope, John, and Sons, 112. Pressley, Thomas, 361. Prestoe, Wm., 314.
- Quercus, 443.
- R., 176. R., Edinburgh, 43. Raïnesque, C. S., Professor of Botany and Natural History, 248. Rauch, Charles, 555. R. B. S., 358. R. C. H., 47. Redstead, Robert, 95. Reid, Robert, 751. Rivers, T., jun., 392. Robertson, John, F.H.S., 165. Rollings, James, 82. Rothwell, M., 693. Rowe, John R., 736. R. S., 475. R. S. B., 176. R. S. T., Exmouth, 374. R. S. T., Holderness, 374. R. T., 570, 611, 645. R. T., F— Cottage, 488. Rudge, Edw., F.H.S. F.L.S. &c., 428, 693. Rutger, T., 172, 577, 681. R. W., &c., 95, 736. Ryan, John, 81.
- S., 243. Sanders, W., 545. Saul, M., 44, 45, 662, 695, 697, 757. Saunders, Richard, 566. Scientific and Justitia Amateur, 137, 641. Selim, 529, 647. Senex, 469. Seymour, W., 373. Shiells, G., 670. Sigma, 42. Small, Thomas, 85. S. M. G., 256. Smith, John, 489. Spence, Wm., F.L.S., 266. Stoveld, John, 92. S.R.B., 372. S. T., 610.
- T. A., 660. Taylor, R. C., 77. Taylor, Samuel, 59, 468. Taylor, W., 154, 668, 735. T. B., 87. T. D., 87. T. E., 68. Thorold, W., 590. T. G., Clitheroe, 502. Trotter, John, 501. T. S., 86. Turnbull, Henry, 108. Turner, Henry, 47, 81, 88, 94, 362.
- Varley, Cornelius, F.L.S., 483.
- W., 360. Watta, Stephen, 499. Whidden, Wm., 731. Willich, Chas. M., 359. Wilson, W., 690. Wood, George, 155. W. W. C., 79, 613. W. Z., 625, 737. Wynne, Wm., 272.
- X. Y., 95, 614, 741.
- Y. A. B., Gl. Young, W., 664.
- ††, Haut Pyrenée, Bagnes de Bigorre, 62.

THE
GARDENER'S MAGAZINE,
FEBRUARY, 1832.

ORIGINAL COMMUNICATIONS.

ART. I. *General Results of a Gardening Tour, during July, August, and part of September, in the Year 1831, from Dumfries, by Kirkcudbright, Ayr, and Greenock, to Paisley.* By the CONDUCTOR.

(Continued from Vol. VII. p. 649.)

GARDENING, as we have before observed, is not so much to be improved from within itself, or by the experience of its practitioners in their own departments, as by calling in, and bringing to bear upon it, other sciences and arts. There are some of our readers, no doubt, who would be much better pleased to see our pages confined to short practical papers on the culture of the different articles grown in kitchen and flower gardens, than to read discussions on subjects of general improvement contained in such articles as those of which the present is a continuation, or to study the accounts of inventions occasionally brought forward in our General Notices. (p. 12.) We consider persons entertaining this opinion as taking too confined a view of our duties; because we know that almost all the improvements of any consequence which have been made in gardening have been drawn from other arts and sciences. What improvements could have been made in the construction or management of hot-houses, for example, unless the gardener had extended his enquiries to the manufacture of iron or other metals into sashes; and to the science of chemistry as applied to combustion and the management of heat? We have no doubt that there are various readers who could see little connec-

tion between the figures of monuments in the churchyard at Dumfries, which we gave in a former Number (Vol. VII. p. 529.), and fountains and sundials for ornamenting flower-gardens and pleasure-grounds; yet it will be seen from communications in our present Number, and in a former one (Vol. VII. p. 724., and Vol. VIII. p. 91.), that our notice of these monuments appears likely to lead to a decided improvement with regard to economy and durability in architectural ornaments for gardens in England, as well as to a beneficial commerce between London and Dumfries. We have been asked what use there was in figuring Witty's patent gas furnace (Vol. VII. p. 482.), and what chance there was of so intricate a contrivance as one that would produce gas being ever made generally applicable in hot-houses. We are mistaken, however, if this furnace does not produce as great a revolution in generating heat for hot-houses, as the introduction of pipes of water has done in conveying and maintaining it. (See p. 26.) A correspondent, Suffolciensis we believe, some years ago attacked us severely for introducing Heathorn's limekiln (Vol. II. p. 403.) into a Gardener's Magazine. If he should happen to see one of Witty's furnaces, and understand the principles of its action, he will be able to comprehend the important improvement made by Heathorn in the preparation of lime, which in agriculture may truly be called the universal manure. Witty's furnace is an application of the same principle as Heathorn's, in a different form and on a smaller scale.

We could refer to a number of similar cases in past volumes to prove the great advantage of bringing all discoveries or inventions that bear any relation to gardening, agriculture, or rural and domestic improvement, before our readers as early as possible.

There is another reason why we should embrace all subjects connected with gardening and rural improvement, as well as botany, physiology, and the mere practice of cultivating fruits and vegetables; and that is, the necessity which exists at the present time for young gardeners to extend the boundaries of their knowledge in all country affairs. The changes which are taking place in society, and the desire of the employers of gardeners to economise, is gradually leading to the union in the same person of the offices of gardener, bailiff, and even land steward. We know various instances both in England and Scotland, in which this union has lately taken place; and we rejoice to see it, for the sake of gardeners, and because we have long been aware of the injury which the agriculture and the farmers of this country have sustained from the employment, as land stewards, of attorneys, who, residing in towns, frequently know nothing of rural affairs. The young gardener, therefore, should not only inform himself upon general subjects, for the sake of keeping himself on a par with mechanics, artisans, and indeed almost every other class of young men, who, in consequence of mechanics' institutions and cheap publications, are making the most rapid progress; but he should especially inform himself upon all matters connected with rural improvement, as the only means of fitting himself for rising in the world. Assuredly the time is fast passing away for a nobleman or rich country gentleman to keep a separate head gardener at high wages for each department of his gardens; or for a man possessing only the art of growing pines or perhaps grapes to perfection, or excelling in any one particular article, to even hope to obtain a first-rate situation. The spirit of the times requires in every man not only a thorough knowledge of his own profession, but much general knowledge, to enable him to keep pace with the rapid changes which are taking place around him.

As a farther portion of the general results of our tour, we shall submit, in the present Number, some general remarks on the gentlemen's seats, and park and pleasure-ground scenery, of the west of Scotland.

The *Gentlemen's Seats in the West of Scotland* are now in a more deserted state than they have been in for many years. Very few of the proprietors reside at them, chiefly, as we were informed, from not having the means (owing to the diminution of their rents, and other causes) of keeping up the requisite establishments, and paying the interest of the mortgages or other encumbrances on their estates. In consequence of this, it will not excite wonder that we found very few gardens kept up in a suitable style. Before this evil can be remedied, material changes must take place in the laws relating to real property, and more especially in the laws of entail and of primogeniture, the evils of which were pointed out by Lord Gardenstone to his countrymen more than fifty years ago. It is proper to mention that the changes which have taken place in the money rent of the land, and in the price of territorial productions, have not been the sole cause of the present neglected state of gentlemen's seats in the line of country through which we passed. A few have overbuilt themselves; and a few also have curtailed their means by gambling or electioneering expenses. The prevailing cause, however, of the sufferings of the Scotch landed proprietors we believe to be the great extent of their mortgages; and as it is clear to us that the means of paying off these, or at least the interest of them, will, in the great majority of cases, rather diminish than increase, the sooner the mortgagors are authorised by the legislature to sell part of their estates, the better it will be both for themselves and the public. It has been shown in a late number of the *Edinburgh Review* that more than half the landed property in Scotland is very strictly entailed.

As compared with the country seats of England, those of Scotland which we saw during our late tour are inferior in point of park and pleasure ground scenery. Nature has done much more for the landscape scenery of Scotland than she has for that of England, by supplying the most striking or interesting features; but man has not yet been endowed with sufficient taste, or rather, perhaps, wealth, to make the most of them. We have heard it alleged, that the difference between Scotch and English parks, with regard to wood and lawn, is owing to the inferiority of the northern climate; but this is one of the greatest mistakes that can be made on the subject. A sufficient variety of trees and shrubs, for all the purposes of the most varied shrubberies and plantations, grow as well in Scotland as in England; grass grows as well, and can be mown as smoothly; and gravel, or a substitute for it, looks as well, when properly managed. There may be fifty or a hundred ornamental trees and shrubs, which endure the open air in the central counties of England, which will not live through the winter in Scotland; but this is of no consequence with reference either to landscape-gardening or ornamental planting. The park scenery of Scotland is inferior, as far as art is concerned, to that of England, chiefly from its confined extent, and the formality of all the lines and forms connected with it. This formality may be traced to the love, in Scotch landowners, of agricultural profits; straight lines, and surfaces uninterrupted by trees, being most favourable for aration. The English *beau idéal* of a park is that of a portion of natural forest scenery, with smooth glades of lawn in some places, and rough thickets of shrubs and ferns in others; but the Scotch idea of a park (judging from the parks as we found them) is that of a pasture field of considerable extent, varied by formal clumps of trees and strips of plantation. Unquestionably the latter description of park is most suitable for a comparatively poor country, because it is better adapted for the maintenance of agricultural stock; but, taking the style of the finest natural scenery as a standard for this kind of beauty, the English park, as a work of art, is by far the most beautiful. The day for extensive parks, however, is gone by; and we have no wish to see large portions of

the country occupied by mere forest scenery, however picturesque it may be. What we should wish to see in Scotland are, numerous small parks of smooth rich pasture, beautifully varied by groups of trees; not put down at random, both as it regards sorts and manner of planting; but the trees and shrubs of many sorts, one kind always prevailing in one place, and the grouping and connection being such as to produce a varied and beautiful whole. Such parks in Scotland will often be placed on the sides or along the base of a range of hilly or mountainous scenery; and when this is the case, every extent that can be desired, both of pasture and of forest scenery, may be obtained without infringing on any principle of utility.

It is remarkable that, in a country abounding with so many fine situations for country residences, there should so often be houses placed in dull flat situations, with nothing to recommend them but the richness of the soil. This we can only account for on the principle that fine situations, being so common, are not duly valued; and that the wealth which can procure a large well-built house anywhere obtains among a poor people more applause than the taste which would place that house in a beautiful situation.

The Pleasure-Ground Scenery in the west of Scotland, more especially near the mansions, is in general very unsatisfactory; partly, we freely admit, from that absence of high keeping which we have found prevalent, and without which, in our opinion, no place is worth looking at; but chiefly from what we think defects in the arrangement. According to our notions of comfort and luxury, the most highly polished scenery, and the finest display of flowers, should always be near the house, and even close to it, on that side which is the least seen from, or connected with, the entrance front. This principle, we think, should be adopted, whether the house be a cottage, a villa, a mansion, or a palace. But, in many places, we have found very little difference in the objects and style of arrangement between the scenery connected with the entrance front and that of the other fronts; the flowers and shrubs, which we would have displayed on the drawing-room front, being placed at a distance from the house, in a flower-garden or shrubbery.

We have no objection to individuals indulging in this taste, or in any other that gratifies them; but we cannot approve of it as calculated to form what, by such persons as have seen all the fine places in England and Europe, would be called a fine place. The general practice in the most beautiful residences in England is, to maintain a character in the scenery of the entrance front, distinct from that of what is called the lawn, drawing-room, or garden front; and we think there is reason in favour of the practice. The drawing-room of every house may be considered as the place where is to be made the greatest display of whatever can render a dwelling desirable; the drawing-room, therefore, should not only be comfortable, and elegant within, but the scenery seen from the windows should harmonise with the general character of luxury and refined enjoyment. To effect this, recourse must be had to ornamental gardening in the foreground, and landscape-gardening in the distance. Ornamental gardening supplies groups of flowers and flowering shrubs, with basket-work, vases, statues, and other ornamental objects; and landscape-gardening guides the taste in the concealment or display of distant groups or masses of trees, water, lawn, rocks, hills, and other materials, natural or artificial, of verdant scenery. The entrance front, on the other hand, is generally arranged in a plainer style, and this also has reason in its favour: first, because it is a place liable to be frequently occupied by horses and carriages, and therefore less suitable for flowers, or the recreation of those for whom flowers are more especially cultivated; secondly, because it seldom happens that the drawing-room windows, and

others of the principal company apartments, look towards the entrance front; and thirdly, because the plainer the entrance front is, the better it will contrast with the drawing-room front.

In many places in Scotland, we found no flowers on either front; and in several, as many on the entrance front as on that of the lawn: but what we disliked the most was that which we frequently met with, viz. a degree of coarseness of surface, rough grass, and a total absence of flowers and fine shrubs all round the house; while there was a flower-garden, and a portion of highly kept lawn at some distance from it, in a shrubbery, or near the kitchen-garden. This we consider both as a want of taste, and a great waste of expense, because no adequate effect is produced. No polish and refinement, no exertions of ornamental gardening in distant parts of the grounds, will ever compensate, in our opinion, for the want of these qualities near what ought to be the centre of all art and refinement, the house. It is not that we disapprove of detached flower-gardens or other ornamental scenes in different parts of the grounds; on the contrary, in large and extensive places where every thing else is in due proportion, we approve of these, as inducements to walk out and examine them, and as adding to the magnificence of the whole; but we can never approve of one of these gardens or scenes in a place where the lawn in front of the house is neglected. Next to utility and convenience, what painters call effect, or what some would call display, with us is every thing.

(To be continued.)

ART. II. *Hints on raising the Leguminous Plants of Australia and the Cape of Good Hope from Seeds, on acclimatising them in Europe, and on their native Habits.* By Mr. J. BOWIE.

Sir,

HAVING procured, while in England, seeds of various species of the Australian *Acaciæ*, and sown them immediately on my arrival at the Cape, I was much disappointed at the apparent failure of many of them, but have found several of them vegetating after being three years in the ground, during which period, they were duly attended in weeding and watering. Seeds, also, of *Acacia longifolia*, saved at the Cape, and sown ten days after gathering, showed the same tardiness in vegetating. This circumstance led me to consider the best mode of treatment in trying experiments with the Cape species of *Acacia*, and other South African *Leguminosæ*, and I find that nearly the whole of this order thrive better by having water heated to 200°, or even to the boiling point of Fahrenheit's thermometer, poured over them, leaving them to steep and the water to cool for twenty-four hours. Where there is a numerous collection, and the quantity small, of each species, they may remain in the papers.

The soil in which to sow leguminous seeds in general, I would recommend, should be one part sandy loam, and three parts thoroughly decayed leaves. The common, or wide-mouthed, 48-sized pots are the best for sowing the seeds in, as they allow sufficient room for draining, and contain enough earth for the short time that may expire before planting out, and the soil in them maintains a more equal degree of moisture than in pots of a larger or smaller size: an essential circumstance to the growth of seeds of every description.

The Cape species of *Leguminosæ* may be sown at any time of the year

they may arrive in Europe: if this should happen to be in the autumn or winter, the growth of the plants should not be forced, as such practice tends only to produce weak plants, which rarely survive till the spring. The front stage or upper shelves in the green-house will be found the best situation for placing autumn or winter sowings: but, taking the months of February, March, and April, as the best and most convenient season for sowing those seeds, the following practice will insure to the European cultivator many species which have hitherto failed, continued scarce, or which have only exhibited poor and stunted specimens, and which, consequently, have been treated with neglect, when, under proper management, they would form suitable and splendid ornaments for the shrubbery, and make more room in the conservatory for less hardy species.

Having sown the seeds (after steeping as above), and covered them with earth from a quarter to a half inch deep, and leaving a space for water of half an inch from the edge of the pot, they must be well watered, and placed in a declining or exhausted hot-bed, not plunging them. If the season is so far advanced that the sun's rays are powerful, the frames should be shaded from its direct influence during the middle of the day. In the earlier stages water need only be applied every third day; or, at least, so often that, without stagnating, the soil is kept constantly moist: alternate drought and superabundant moisture retard and check the progress of vegetation.

As the various species make their appearance, and the cotyledons become fully developed, the pots containing them should be separated from the rest, and placed in other frames, where they will require a more constant supply of water and admission of air, duly encouraging their growth until of a sufficient size for planting out. In this, the experience of the cultivator must guide him; but it is necessary to observe, that the first planting out should be accomplished while the plants are in a progressive state of growth, shading them if necessary.

In large establishments, the person intrusted with the management of the seeds is, or at least ought to be, a confidential person, and therefore ought to be put in possession of the lists, and any other written observations which may accompany packets of seeds from abroad. By these, he is enabled to allot to each species the peculiar earth required, of which he must be sometimes ignorant, when he meets with species new to him.

Whatever soil may be required for the plants, care must be taken not to pulverise it too finely by sifting; for the tap root in its descent, on meeting with any obstruction in its perpendicular direction, receives an impulse approaching to animal instinct, and, rounding the impediment, forms sooner its lateral fibres and roots, which are to become organs of nourishment for the future tree, &c. This will not be generally the case with plants placed in earth sifted as fine as snuff; their state of health is shown by the sickly hue of the leaves, which prematurely fall off; and, upon examination, the root will be found embedded, as it were, in a condensed cement, which all the efforts of nature cannot penetrate.

As soon as the young plants are established in the pots, they must be removed from the frames, and plunged in prepared beds of decayed bark, formed at or under the level of the natural ground; and occasionally supplied with water until the middle or latter end of August, when they are to be raised and the tap root cut off, if it should have passed the aperture at the bottom of the pot. They may remain above ground until housed for the winter, during which season as much air and as little fire heat as possible should be administered. In a general collection, it is impossible to allow every species its proper atmospherical temperature, but long confined air and damp are as injurious to vegetable as they are to animal life. There are generally some bright days occurring during the

winter season in Britain : those opportunities should be embraced to purify the houses by throwing open the doors and sashes, and keeping up a brisk fire in the morning, as often as may be judged necessary.

There are few Cape plants but what will resist the effects of some degrees of frost ; the *Plectránthus fruticósus*, a native of the Cape forests, is the most susceptible of injury from cold, and, if properly placed in the house, proves a warning thermometer against direct injury, as it is the first to suffer, and consequently show the increasing harm.

Of the South African Leguminósæ, the following genera form striking and beautiful ornaments in their native wilds, particularly to those who are charmed with the outward appearance and varied colours of flowers : and although the nature of the native soil where they are found to abound may be variable, a sandy loam with decayed leaves is the most genial to the growth of most species of Cape Leguminósæ, and may therefore be used in general collections.

Omphalòbium, *Schòtia*, *Sophòra sylvática*, *Cyclòpia*, *Sarcophýllum*, *Borbònia*, *Crotalària*, *Cýtisis*, *Anthýllis*, *Sutherlandia*, *Indigófera*, and *Aspálathus* generally indicate the existence of a red sandy loam.

Acàcia, *Virgília*, *Loddigèsia*, *Vibórgia*, *Ráfnia*, *Psoràlea*, *Onònis*, and *Cylística* thrive with greater luxuriance on the margins of streams, in alluvial and vegetable soils : but many species of the same and of other genera vary from the general rules, and are found either in pure sand or in stiff clay, exposed through great part of the year to excessive heat and drought, or but slightly sheltered and nurtured by the mountains ; but deriving much of their subsistence from the dewy clouds which those heights, as these clouds pass over them, arrest and condense. So readily do South African plants appear to accommodate themselves to soils and situations, that it is difficult to positively recommend any particular compost for them in garden culture : practical experience must alone decide the best for the purpose.

The insatiate desire of novelty is so inherent in man, that the labours of individuals in all parts of the earth are insufficient to satisfy this craving. How many are there who, for want of room, crowd or neglect many fine plants, for the sake of less beautiful and less useful species ! Scientific establishments are not free from this error ; and the evil increases, and is so obvious to many real admirers of Nature, that they cannot help regretting the practice ; though themselves verge on, and not unfrequently fall into, the same mania which they decry in others, and neglect to take the necessary steps for the preservation and better culture of old introductions. This unpardonable negligence is particularly exemplified in the Cape genera, with the exception of *Erica* and *Pelargònium*, the cultivated plants of which excel those in their native wilds.

The modern improvements in the construction of stoves, green-houses, and conservatories, and the means of applying the necessary warmth to them, relieve the gardener of much manual labour, and prevent a great deal of that anxiety of mind which formerly deprived him of bodily rest during a severe and lengthened winter. We still, however, find a few sluggards slumbering at their posts, whose duty to themselves and to their employers can hardly be aroused to activity, by observing occasionally the flourishing collections of their neighbours. You will please to remember that it is a gardener who writes this, and does not intend to cast any reflections on the profession ; but he trusts that you will still continue to advise the young and aspiring in their duty, and prepare them for the part they may have to perform on the great theatre of the world. You must pardon this digression, but it obtrudes itself to my thoughts, and I commit it to paper, and fancy to myself that it is not altogether irrelevant to what may follow. Something more than the mere mechanical operations,

and the knowledge of botanical nomenclature, is expected from the gardener of the present day. Independent of his immediate duty to his employer, he has a duty to perform to his country, and one which he may perform with ease and pleasure to himself, that is, the acclimatisation of exotic plants; which may frequently be attempted with old specimens, that would, at all events, be committed to the flames: and if he be successful, your pages are open to record his fame, and societies are numerous in England, and liberal enough to reward his merit.

The forming of portable houses for the reception of Leguminosæ would amply repay the amateur for the trouble and expense, by the splendour which plants having a sufficiency of room would exhibit. I would therefore recommend the planting in beds of prepared soil (formed in such structures as fancy might determine or circumstances permit), masses of this natural order, arranging them so that every plant might receive an equal portion of the sun's rays through the day; placing the taller in the centre, and gradually diminishing the lines to the edge, where the minor kinds would form the border, and would not exceed the height of many species of the mosses. The grouping of colours must be left to a refined taste, so that the various shades, as far as practicable, may be blended on scientific principles.

If young plants, say of three years old, are intended for the above description of houses, they should be brought as early as possible to a fit state, by giving them larger pots than they would have allowed to them, were they intended for the stage or shelf of a green-house. As young plants will be small in proportion to the space they are hereafter to fill, several of a species may be plunged over the rim of the pots, and marked for future removal: this will, without deranging the plan, allow sufficient room for those which remain; those to be removed, having a ball of earth attached to them, will be fit specimens to try in the open air. For this experiment I would rather recommend a northern exposure for planting than a southern one, where, after severe frosts, a sudden thaw does most mischief, and in many instances is the real cause of death to the plants. If large plants, thus exposed, appear killed by cold, too much haste must not be exercised in removing the roots, but cut down the stem, and let the stool remain for one or two years. When old plants are intended for the portable house, or for a conservatory, they should be headed down to a convenient height, allowing sufficient room for their heads to form free of the roof; and as the various species of *Schôtia* flower occasionally on the old wood, and the others at the extremities of the young spring and summer shoots, this habit should be strictly attended to, and borne in mind at all seasons.

Many persons regret the loss of old established plants, and, in the vain attempt to preserve them in a confined space, permit injuries to be inflicted upon them by injudicious pruning, which eventually forms unsightly and disagreeable objects for a house. They are then condemned, and in the autumn are left out, and exposed to every vicissitude of season, and no opportunity is given them to live. It is early in the spring months that these plants should be selected, and planted out in sheltered situations of the shrubbery: they would at least have a chance of existence, and, if they should die, their loss would not be so apparent. It has become a very common practice in Europe, to plant exotic shrubs in front of the stoves and green-houses indiscriminately, and without thought of their ultimate height, or whether they can be kept within bounds by pruning without injury or total prevention of flowering: this point requires consideration, or the plants are likely to become nuisances.

Omphalòbium, *Virgíliæ*, *Sophòra*, several *Psoràlææ* and *Cýtisi*, form a distinct stem; *Schôtia*, *Indigófera*, *Psoràlea*, *Aspálathus*, *Podalýria*, *Lipària*, and *Borbònia*, as well as *Cyclòpia*, *Sarcophýllum*, and *Ráfnia*, form

branching shrubs from the collar: in the three last-mentioned genera this habit should be encouraged as much as possible; by cutting them down to the ground; it encourages the larger growth of the collar, and in old plants the appearance of nakedness would be but temporary; the quick growth of numerous shoots, especially in old plants, would form dense bushes, and stronger and more characteristic masses of flowers. *Omphalobium* and *Schötia* are of slow growth: planting them under the shade of others will draw them up to the requisite height without injury.

By confining this communication to Leguminosæ, I do not wish to exclude the plants of other natural orders; but the first is given to illustrate what will, if put in practice, add to the pleasure of the cultivator, by ornamenting, without confusion, and prevent the destruction or neglect of many interesting plants, from ignorance of their worth, and from not beholding them in full vigour of health and beauty.

I am convinced, from observation, that many Australian leguminous plants require the same treatment as those of South Africa, especially among the rigid-leaved species, as *Daviësiæ*, &c.; consequently a mixture of plants of both countries would no doubt thrive.

I subjoin a list of the average height which several species attain in their native habitations: it may partly guide the cultivator in planting:—

	Ft.	in.
<i>Virgilia intrusa</i> and <i>capensis</i>	-	25 0
If <i>Virgilia</i> is deeply injured in the old wood, a gum exudes, which is used as gum arabic.		
<i>Omphalobium</i>	-	12 0
<i>Sophora sylvatica</i>	-	16 0
<i>Psoralea pinnata</i>	-	15 0
<i>Cyclopia</i>	-	4 ft. to 10 0
<i>Indigofera cytisoides</i>	-	8 0
<i>Podalyria styracifolia</i>	-	9 0
<i>Aspalathus</i>	-	6 in. to 4 0
<i>Rafnia</i> (annual growth)	-	2 ft. to 3 0
<i>Sarcophyllum</i> (annual growth)	-	1 6
<i>Liparia sphaerica</i>	-	3 0
<i>Acacia capensis</i> or <i>nilotica</i>	-	20 0
<i>Acacia caffra</i>	-	12 0

The latter thrives best by being cut down and confined as a shrub to 6 ft. They both yield the gum arabic.

Erythrina caffra attains the height of 60 ft., but flowers at the height of 15 ft.

Erythrina nana, introduced by me to England in 1823; flowers at 2 ft., and may be considered as half-shrubby, as it scarcely ever attains a permanent stem. It is a desirable plant.

I hope that you will not consider the above too tedious; and should wish you to enforce some of the hints therein. I have no time for corrections, so that you must excuse all errors, as the cultivator would freely pardon the prolixity of the collector, if he had to encounter but one tenth part of the difficulties the latter meets with.

I remain, Sir, yours, &c.

JAMES BOWIE.

Cape of Good Hope, February 16. 1831.

ART. III. *An Account of the Common and Highland Pines, as found in Scotland.* By J. G.

Sir,

IT has lately been ascertained that there is a variety of pine in Scotland very different from, and greatly superior to, the common tree of that name, in size, quality, and durability. It has long been known, indeed, that the wood of the one is preferable to that of the other; yet people were always inclined to reckon them both under the general title of Scotch pine, and to take for granted that the difference must be occasioned by age, soil, or situation. That any or all of these causes can account for the difference is, I think, far from probable. How can age be thought a sufficient reason, while it is known that thousands of the common pine have arrived at maturity, and thousands have died, which at no period of their age were better than those which are every day felled for the most ordinary purposes? How can soil or situation be given as a reason, while it is known that the common pine is scattered over all Scotland, in as good soils and situations as those in which the superior sort grows, and yet are found, when cut up, to be but of inferior quality?

This superior variety abounds in the highland districts of Abernethy, in Strathspey, and in the north of Scotland; and the first individuals who collected the seeds, and raised plants of this sort, were Messrs. Alexander and John Grigor, nurserymen at Elgin and Forres, at whose nurseries plants of these pines are always to be found, and for whose exertions the Highland Society of Scotland awarded their premium. These gentlemen, in the short period of two years (the time they require before being fit for transplanting), raised and sold no less a quantity than two millions of the real highland pine, and thus put into the possession of landholders a variety that produces wood equal to that brought from Norway.

The late Mr. Don of Forfar considered that this pine, which I have termed a variety, should, on account of its great dissimilarity to the *Pinus sylvestris*, its long tufted leaves, and the horizontal direction of its branches, constitute a distinct species, which might, with propriety, be termed *Pinus horizontalis*. The members of the Highland Society have adopted his opinion; and one of the most distinguished writers of the day (Sir Walter Scott), in an article in the *Quarterly Review*, some years ago, pointed out, with singular effect, not only its peculiarity of shape, &c., but the amazing durability of its wood.

I shall record a circumstance that occurred in the north of Scotland, which proves, beyond the reach of doubt, that there must be two distinct species of Scotch pine. About fifty years ago, a young forester happened to be travelling over that district in which the real highland pine abounds. As he passed along, he observed a few small ones springing up among the heath; and being struck with the appearance they presented, and having a plantation of common ones going on at the time, he pulled one, wrapped it up, and, having arrived at his plantation, he planted it along with the rest, and placed a durable mark beside it. During the whole period of its growth, this tree presented a singular appearance; and when it was felled and cut up (which happened about ten years ago), it was found superior to any of the surrounding ones. Now, this is a proof that must remove every idea of a variation in soil, age, or situation accomplishing the existing difference; a proof that there are in Scotland forests of a pine superior to the common, and remote enough from it to constitute a species.

Shall I yet be told, then, that there is no difference? Yes; there are still some who maintain it: and, but for this fact, I should have treated the subject in a different manner. There are still some who have, through

ignorance, attempted to overturn all this, and, in supporting their position, have employed the most unreasonable arguments. The march of discernment, however, is moving on, and, I rejoice to say, it will soon leave them in merited obscurity. I can account for their adopting such an opinion in no other way than by supposing that they have never seen the magnificent highland pines; for it is almost impossible that any person with his eyes open could pass over those districts in which they abound, without perceiving the difference in appearance; and it is well known that the wood-merchant, and the meanest carpenter on Scotia's mountain side, can alike point out the superiority of the timber of the highland pine over that common worthless species which has been so long propagated, and with so little benefit to the country.

The members of the Highland Society of Scotland have been among the first to direct attention to this subject, and their exertions have been successful. Landholders are now eagerly enquiring after the "new sort," as they call it, and are determined to banish the "old" from their estates. They have long experienced the uselessness of the one, and are now convinced of the excellence of the other. They have seen that the common pine can only be used for paling fences or fuel; while the other can be applied to the most important purposes in building.

It is pleasing to think that our northern gentlemen are now carrying on an improvement which must not only benefit themselves but the country generally; and alike pleasing to think that a proportion of those immense tracts of waste land, that everywhere abound in Scotland, may soon groan under a load of pines equal to those that flourish on the Norwegian hills.

It is truly astonishing to think, that, while some proprietors in Scotland are doing their duty in the way of planting the waste land on their estates, others, though possessing the means, are still allowing thousands of acres to lie idle, which might long ere now have been returning them a great recompense for the trifling expense of planting. They seem to have totally forgotten Sir Walter Scott's anecdote of the dying laird's advice to his son.

Laying aside ornament, shelter, &c., planting has always been considered a good speculation, on the score of pounds, shillings, and pence; and how can it be otherwise, when we know that plants of larch and Scotch pine can be furnished and planted for the small sum of twelve or fourteen shillings an acre?

I shall, perhaps, recur to this subject at some future period; and should any of the readers of your Magazine be inclined to doubt what I have brought forward, I shall be happy to meet their objections.

I remain, Sir, yours, &c.

J. G.

Kensington, Dec. 1831.

MISCELLANEOUS INTELLIGENCE.

ART. I. *Notices of Plants recently imported, figured, or described, and such Notices of old Inhabitants of our Gardens as may be likely to interest the Cultivator or Amateur.*

COLUMN 3. <i>Habit.</i>	
☿	Deciduous tree.
♁	Evergreen tree.
♂	Palm tree.
♁	Deciduous shrub.
♁	Evergreen shrub.
♁	Deciduous under-shrub.
♁	Evergreen under-shrub.
♁	Deciduous twiner, ligneous or herbaceous.
♁	Evergreen twiner, lig. or herb.
♁	Deciduous climber, ligneous or herbaceous.
♁	Evergreen climber, lig. or herb.
♁	Deciduous trailer, lig. or herb.
♁	Evergreen trailer, lig. or herb.

♁	Deciduous creeper, lig. or herb.
♁	Evergreen creeper, lig. or herb.
♁	Deciduous herbaceous plant.
♁	Evergreen herbaceous plant.
♁	Grass.
♁	Bulbous plant.
♁	Fusiform-rooted plant.
♁	Tuberous-rooted plant.
♁	Aquatic.
♁	Epiphyte.*

COLUMN 4. *Duration and Habitation.*

△	Perennial.
○	Biennial.
○	Annual.

□	Bark, or moist, stove.
□	Dry stove.
□	Green-house.
└	Frame.
⊠	Bark stove perennial.
⊠	Dry stove perennial.
⊠	Green-house perennial.
⊠	Frame perennial.
⊠	Bark stove biennial.
⊠	Dry stove biennial.
⊠	Green-house biennial.
⊠	Frame biennial.
⊠	Bark stove annual.
⊠	Dry stove annual.
⊠	Green-house annual.
⊠	Frame annual.

Where the tabular lines occur, the species whose details they contain are additional to those in *Loudon's Hortus Britannicus*.

Occasionally a species may be repeated for the sake of exhibiting its details more accurately than they are exhibited in the *Hortus Britannicus*. Such species will have a dagger (†) prefixed to them.

To the genera new to the *Hortus Britannicus* a star (*) will be prefixed. The books cited in italics in the column for "references to figures" are quoted for description or incidental notices; these being the best substitutes for figures or perfect descriptions, until figures or perfect descriptions are published.

The dates introduced after hybrids are those at which they were raised from the hybridised seeds, as nearly as these dates can be ascertained.

The numbers prefixed to the orders are those they bear in Lindley's *Introduction to the Natural System*.

Where blanks occur in the place of specific names, they will proceed from this cause: Professor Lindley determines to figure showy hybrids and garden varieties, but neither to give them a Latin specific epithet nor descriptive description, nor to state their relative place in systematic arrangements. Carton's rhododendron, Low's lobelia, and Young's calceolaria are three instances; but to the latter two the epithets in use in the nurseries are applied below.

CLASS I.

Plants endowed with a Vascular Structure and obvious Blossom.

SUBCLASS I.

Plants with Exogenous Growth and Dicotyledonous Seed.

DIVISION I. Plants with a Polypetalous Corolla.

I. *Araliæcæ.*

Remarks on this order are incidentally expressed by Mr. David Don, in Sweet's *British Flower-Garden* for Jan. 1832, t. 125: they are these:—"I wish here to correct a grave error, into which I had fallen in *Præ-*

* Epiphytes are plants growing upon other plants, deriving from the latter nothing but their local habitation; parasites grow into, and absorb their nutriment from, the plants which bear them: epiphytes are numerous within the tropics; parasites are few everywhere, and, in Britain, limited to *Ficus album*, *Cuscuta purpurea*, *Cuscuta Epithymum*, *Lathræa Squamaria*, the species of *Orobanche*, and many species of *Fungus*; perhaps *Monótropa Hypopitys*, and a few other plants. J. E. Bowman, in late researches among the British parasitic plants, has seen cause to believe that *Nectria nidus avis* is not parasitic. — J. D.

dromus Fibrae Nepalensis, p. 186., in ascribing to the Araliaceæ 'semina erecta' [erect seeds] instead of 'semina pendula' [seeds pendulous]; and although I have been long aware of the blunder, it is only now that I have had an opportunity of correcting it."

This correction does not apply to Lindley's *Introduction*, which accurately describes the seeds as pendulous.

11. Umbelliferae.

881a. *PRA'NGOS* Lindl. PRANGOS. (Native name most probably.) 5. 2. *Umbelliferae*. [Dec prod. 4.239
pabularia Lindl. food-yielding Δ ec | 1 ... Yshw E. Indies. 1824. S 1 Wl.pl. as. rar.212

In the 9th number, recently published, of Wallich's *Rarer Asiatic Plants*, the prangos hay plant is figured and described; and such extraordinary agricultural properties are ascribed to it that we take the earliest opportunity of noticing it to our readers.

"Its properties as a food for agricultural animals appear to be heating, producing fatness in a space of time singularly short, and also destructive to the Fasciola hepatica, or liver fluke, which in Britain, after a wet autumn, destroys some thousands of sheep by the rot, — a disease that, to the best of my [Mr. Moorcroft's] knowledge, has in its advanced stages proved incurable. The last-mentioned property of itself, if it be retained by the plant in Britain (and there appears no reason for suspecting that it will be lost), would render it especially valuable to our country. But this, taken along with its highly nutritious qualities, its vast yield, its easy culture, its great duration [a single planting will continue in healthy and profitable growth for forty years or more; hence the plant is a most durable perennial], its capability of flourishing on lands of the most inferior quality, and wholly unadapted to tillage, imparts to it a general character of probable utility, unrivalled in the history of agricultural productions. When once [it is] in possession of the ground, for which the preparation is easy, it requires no subsequent ploughing, weeding, manuring, or other operation, save that of cutting and of converting the foliage into hay. . . . From various facts it is conceived not unreasonable, to presume, that, by the cultivation of this plant, moors and wastes, hitherto uncultivated, and a source of disgrace to British agriculture, may be made to produce large quantities of winter fodder, and that the yield of highlands and of downs enjoying a considerable depth of soil may be trebled."

Britain does not yet contain living plants of *P. pabularia*, although it appears that seeds of it were sent here as early as 1824. Whether when living plants be possessed, British winters may not be too severe for them, remains to be proved; but the writer above speaks as if he had little or no doubt on this point; and, as the plant is from a temperate part of the East Indies (the neighbourhood of Imbal or Droz), it may possibly be sufficiently hardy.

A figure of *P. pabularia* will be found in Vol. II. p. 355. under the remarks on *Arracacia* esculenta, a perfectly different plant.

III. Ranunculaceæ & spuriæ.

PÆONIA Moûtan carnea plena, the semidouble tree pæony, deserves to rank among the finest of the varieties of the beautiful species to which it belongs. In the gardens, where it is at present extremely rare, it is called "the Double Papaveræcea Pæony;" a name we are obliged to alter, because it is a variety of *P. Moûtan*, and not of *P. papaveræcea*. (Lindley in *Bot. Reg.* 1456.)

In this order, that peculiar plant *Knowltonia rigida* is (Jan. 15.) displaying its compound umbel of greenish-white flowers, in a green-house at the Chelsea Physic Garden; where, in the open air, trained to the face of a wall, *Clématis pedicellata* Swt. (*Clématis cirrhosa* β *pedicellata* Dec.) abounds in pendulous blossoms. This species is far more prevalent than may be suspected. Not many have observed the technical distinction which distinguishes it from *C. cirrhosa*, whose blossoms are sessile, or nearly so, in relation to the involucre; while those of *C. pedicellata* are stalked. The Christmas rose (*Helleborus niger*) may be found in the gardens, exhibiting, in flowers recently opened, its snow-white sepals, which, as they advance in age, acquire a green colour, and ultimately a red one.

X. Fumariaceæ.

*2050a. *DACTYLOCA'PNOS* Wal. (*Daktylos*, finger, *kapnos*, fumitory; berries finger-shaped.) 17. 2.
thalictrifolia Wat. *Thalictrum*-lyd $\frac{1}{2}$ O or 3 au. o Y.Br Nepal 1831. ? S s.l Sw.f.gar.2.s.127
Diclytra scandens Don *Prod. Fl. Nep.*

Possessed by Messrs. Whitley, Brames, and Milne, at Fulham.

2047. *CORYDA'LIS*.

19187a *bibractæata* Haw. 2-bracted $\star \Delta$ or $\frac{1}{2}$ f.my Pk O co *Haworth, MSS.*

XXXIV. Malvaceæ.

2014. *HIRI'SCUS palustris* L. This lovely species is hardy, but the specimen figured was produced in a stove; for although the plant adorns the swamps of America, from Canada to Carolina, it does not blossom satisfactorily in the open air of England. This defect Professor Lindley imputes "to the general lowness of our isothermal [open air] temperature." [I have seen it blossom in the open air, planted in rich loam, at the base of a south wall, where its annual stems were stout, a yard high, and the foliage large and healthy.] Seeds of this charming plant may be procured abundantly from North America, and are often imported for sale along with other American productions. (*Bot. Reg.* 1463.)

MA'LVA miniata. This mallow is deservedly prized for its free growth and abundantly produced vermilion blossoms. It is suffrutescent, but is culturable as an annual: thought to be a native of Chile, hence not absolutely hardy. (*Sweet's Flower-Garden*, n. s. 120., Nov. 1831.)

In the Chelsea Botanic Garden, *Malvaviscus arboreus* displays its flowers. A species of *Hibiscus*, whose name is not there known, now blooms at Young's: in foliage and in flowers it approaches *H. Mahol*.

XXXVI. Hypericinetæ.

2192. *VISMEA*.
glabra B. C. smooth $\star \square$ pr 5 jl.au R S. Amer. ... C 1,p Bot. cab. 1752

XLIV. *Escallonietæ*.

687. *ESCALLO'NIA*.
 \dagger *montevideensis* Lindl. Monte Video $\star \square$ or 6 au W Mon.Video 1827. C p.1 Bot. reg. 1467
E. bifida Lk. & O. Hort. Brit. No. 28118.

An evergreen shrub, whose white flowers are produced in large corymbose panicles at the extremity

of almost every shoot: they are very fragrant, with an odour resembling that of hawthorn. Comparatively hardy, and deemed the finest species of *Escallonia* yet in Britain.

LII. *Salicaria* & *Lagerstræmia*.

1588. LAGERSTRÆMIA.

13918 Indica

2 rosea B. C. rosy ■ □ or 12 au.s Ro China 1825. C r.l Bot. cab. 1765

LX. *Proteaceæ*.

316. GREVILLEA.

planifolia R. Br. MSS. flat-leaved ■ □ or 2 my.jn Ro N. S. W. 1828. ? C p.l Bot. cab. 1737

G. concinna Lindl. in *Bot. Reg.* 1383, not of Brown's *Prod.* nor of Sweet's *Flora Aust.* It is the *G. Seymouria* of Sweet's MSS, and is admirably described, and thus denominated, by Mr. Sweet, in *Gard. Mag.*, vol. vii. p. 506. The plant is in Low's Nursery, and also in Colvill's; and Mr. Riath, the skilful foreman of the latter establishment, remarks that Mr. Brown had in MSS. denominated it *G. planifolia* previously to Mr. Sweet's naming it *G. Seymouria*: as, therefore, a figure of the plant has since been published in the *Botanical Cabinet*, under Mr. Brown's first applied name of *G. planifolia*, possibly this name had better be adopted, although Mr. Sweet was the first to publish a name and description of the species. His able description of it will be found in *Gard. Mag.*, vol. vii. p. 506.

Grevillea rosmarinifolia is blooming at Knight's and Young's, *G. linearis* at Young's, and *G. arenaria* at the Comte de Vandes's.

*326a. HEMICLIDIA R. Br. (Probably from *hemisus*, half, and *kleiō*, to shut up.) *Proteaceæ*.

Baxteri R. Br. Baxter's ■ □ or 3?jn Y Lucky Bay ... C p.l Bot. reg. 1455

A very handsome evergreen shrub, recently from Lucky Bay in New Holland, well furnished with spiny oak-like leaves. It is closely allied to the genus *Dryandra*.

Two fine plants of *Hemiclidia Baxteri* were blooming (20th) at Young's. It is, indeed, a charming shrub; its "pinnatifid leaves, whose lobes are ended by a pungent mucro, are devoid of glands on the surface, but beneath are reticulated, veined, and the pitted areoles filled with a crispate wool, and separately occupied by a gland in their bottom." *Brown*.

Mr. Brown, in the recently published *First Supplement to the Prodrômus of the Flora of New Holland*, describes many new species belonging to this order; and, in the preface to the *Supplement*, exhibits some remarks on certain peculiarities which proteaceous plants present in the structure of their leaves. After briefly noticing the systematic parts of his book, he remarks, "I have also added under each genus a few observations mainly relating to the structure of the leaves, and more particularly descriptive of those organs belonging to the epidermis, which by many authors are called pores and stomata; but which by some are, and I think with greater propriety, denominated glands. For these cutaneous glands, as far as I have been able to determine, are often truly inoperculate, and exhibit a disk formed of a membrane in some cases transparent, in others opaque, and occasionally, though very rarely, coloured. Each of these glands, which are quite minute, occupies either wholly or in part one of the areoles of the epidermis; these areoles (or portions of the leaf which intervene the reticulations of a leaf) being usually small, but sometimes large, and generally more or less varied in their form. The figure of the glands themselves is usually oval, sometimes roundish, rarely dilated crosswise, and still more rarely they are angular. The limb is either composed of two distinct segments nearly parallel, but slightly arched, or often annular and continuous, as if from the confluence of the two segments at their extremities: the disk is sometimes nearly oval, and sometimes linear, but very rarely angular; it is not unfrequently double, the exterior one being usually oval; the interior one resembling a very narrow cleft, and being sometimes opaque, at others transparent, and sometimes, perhaps, perforate. In certain families of plants, the cutaneous glands are sometimes found only in the surface of the leaves, and sometimes they are found in both faces, i. e. subface and surface. They occupy both faces in all the proteaceous plants of southern Africa, except in *Brabëum*, in which, as in all the hitherto known *Proteaceæ* of America, of Asia, and of the islands of New Zealand and New Caledonia, the cutaneous glands are obvious in the surface only. About one third part of the proteaceous plants of New Holland exhibit leaves whose surface (not subface) is completely destitute of glands; and this fact is the more remarkable, inasmuch as an especially large number of the trees and shrubs of Australia have both the faces of their leaves equally furnished with glands; the prevalence of which structure, and this usually accompanied by the vertical position and exact similitude of the faces themselves, imparts an almost peculiar character to the woods, and especially to the extra-tropical ones, of New Holland and Van Diemen's Land.

In many genera, not only in this but in other orders, there prevails a conformity in the cutaneous glands in their figure and position, and in their proportion to the areoles of the epidermis; inasmuch that, by accurate inspection of these organs, it is often possible to ascertain the limits of genera, and sometimes the affinities of genera or of their natural sections; it must, nevertheless, be confessed that, in some genera, and in some of those of the New Holland *Proteaceæ*, considerable diversities in the figure and position of the glands may be found."

At Knight's, two specimens of *Banksia cricifolia*, each 6 ft. high, are bearing numerous cones of flowers.

LXII. *Aristolochiæ*.

2582. ARISTOLOCHIA.

22844a caudata Lindl. tail-tipped 3 □ cu 5 jn Ld Brazil 1828. Sk It.l.r Bot. reg. 1453

"A creeping perennial from Brazil, with numerous branches extending for several feet from the root, and sometimes attaching themselves to other plants which grow near them." The leaves are dark glaucous green, roundish cordate, almost kidney-shaped near the root, but three-lobed towards the end of the branches. The flowers are very extraordinary, being pitcher-shaped, of a yellowish brown colour, deeply marked with prominent veins on the outside; the upper lip is fleshy, and similarly veined; the under side of it, as well as the narrow elongated part, is of a very dark brown colour, tinged with yellow at the points. From the bottom to the throat of the flower is about 2 in.: the length of the extraordinary caudate or tail-shaped "lip is nearly 18 in." Thrives in light rich loam in the stove, and is readily increaseable by its creeping roots. In affinity it is near *A. trilobata* noticed in Vol. VII. p. 339. Raised at Sir Charles Lemon's seat, Carclew, Cornwall. (*Bot. Reg.*, Nov. 1831.)

LXXII. *Sanguisorbæ*.

CEPHALOPUS follicularis, the New Holland pitcher-leaf; a truly extraordinary and wonderful plant. The term pitcher-leaf instantly calls to mind the far-famed pitcher plant, *Nepenthes distillatoria*; but

this differs from that most essentially. *Nepenthes distillatöria* is an evergreen climbing plant, attaining the height of from twelve to twenty feet, and has its large ovate-lanceolate leaves disposed alternately along its stem, and each leaf sustains from its tip a long depending pitcher. In *Cephaëthus* there is no stem, save the flower scape, which is leafless, and but from one to two feet high; and although the leaves and pitchers of the plant are produced altogether in a rosaceous radical tuft, the pitchers are distinct from the leaves, and have footstalks of their own.

Dr. Hooker describes the plant minutely and excellently, and illustrates it by two plates; one exhibiting the entire plant; the other, magnified dissections of its pitcher, flowers, and fruit. The leaves are clustered, elliptical lanceolate, petiolated, entire, thickish, nerveless, and purplish; and amongst these, but principally occupying the circumference [of the cluster or tuft], are several beautiful and highly curious pitcher-shaped appendages. These are ovate or somewhat slipper-shaped, between foliaceous and membranaceous, green tinged with purple, furnished with two lateral oblique wings, and one central one; the latter remarkably dilated at the margin, and all beautifully fringed with hairs. The inside, which contains a watery fluid, and entraps many insects, especially ants, is clouded with dark purple. The mouth is contracted, horseshoe-shaped, annulated, and crested with several deep, sharp, vertical annuli, of a dark purple colour, each of which, as Mr. Scott pointed out, terminates in a sharp point that projects over the mouth of the pitcher, as if, possibly, to prevent the escape of the entrapped insects. Lid of the pitcher flattish convex, green without, and a little hairy, within clouded with purple, marked with broad veins, and scalloped at the margin; at first the lid closes the mouth of the pitcher, but afterwards becomes nearly erect. (*Bot. Mag.* 3118, 3119.)

Living individuals of this extraordinary and wonderful plant are thriving in one of the stoves in Mr. Knight's Exotic Nursery, under the skilful management of Mr. Scott.

LXXIII. *Rosæcæ* § *Spirædæcæ*.

PU'RSHIA tridentata. "A hardy inelephant bush, having a glaucous aspect, and dull pale greenish yellow flowers." From North-west America, by Mr. Douglas. Flowered in the Chiswick Garden, for the first time in April, 1830. Grows freely in heath-mould, and is easily propagated by layers. (*Bot. Reg.* 1446.) Desirable to all possessing a taste at all botanical, both on account of the botanist it commemorates, and of its conspicuous distinctness of character.

Rosæcæ § *Dryadæcæ*.

1537. SIEVE'RSIA. *rosea* *Grak.* rosy $\frac{3}{4}$ Δ or $\frac{1}{2}$ my Rocky mo. 1827. D p.l *Edin. n. phil.* [*Journ.* 1831, 193.]
Sent home by Mr. Drummond.

LXXVII. *Leguminosæ* § *Sophoræcæ*.

2151. GOMPHOLOBIUM. Knightianum Lindl. Knight's $\frac{1}{2}$ \square el $\frac{3}{4}$ au.s B New Holl. 1830. S p.l Bot. reg. 1468
"It is a delicate plant, requiring a good airy situation." Raised by Mr. Knight, from Baxter's seeds.

BAPTISIA perfoliata "Coming from the dry sandy hills of Georgia, it might well be supposed to be a tender plant; hence, Messrs. Loddiges and others deem it a green-house plant. In the peat border of the American ground, Glasgow Botanic Garden, it has survived two winters, and flowers in great perfection during July and August. The yellow blossoms are neither large nor showy; but its perfoliate leaves of so unusual a character for a leguminous plant, and their tender glaucous green colour, render it eminently deserving a place in every garden." (*Bot. Mag.* 3121.)

Leguminosæ § *Lôtæcæ* § 1. *Genisteæ*.

1966. ONONIS section NATRI'DIUM. peduncularis Lindl. peduncled $\frac{1}{2}$ \square fr 1 ap W. Ro Teneriffè 1829. S s.l Bot. reg. 1447
A pretty new species from Teneriffè, so not hardy; slightly shrubby, simple-leaved, blooms in April, and has whitish corols margined with rose. Messrs. Young of Epsom have the plant.

LOTUS jacobæus. Mr. Maund has grown as an annual, by planting in the open air, as soon as the frosts of spring are past, a plant from the green-house, which, by autumn, produced seeds to sow as annual seeds in the spring following. (*Bot. Gard.* 326., Oct. 1831.)

Leguminosæ § *Lôtæcæ* § 5. *Astragâlæcæ*.

2100. PHACA. \dagger 18846a astragilina Dec. Astragalus-like $\frac{3}{4}$ Δ pr 1 ju.jl W.B Scotl. Clova mo. S s.l Bot. cab. 429]
A newly discovered addition to the native flora of Britain.

Leguminosæ § *Hedysâræcæ* § 2. *Euhedysâræcæ*.

1980. ADE'SMIA. glutinosa Gill. & Hook. slender-lvd $\frac{1}{2}$ \square or 2 ... Y Chile 1831. S s.l *Hook. ch. plants.*

Leguminosæ § *Viciæcæ*.

2136. LA'THYRUS. 19322a decaphyllus Ph. ten-leaved $\frac{1}{2}$ Δ or 4 ju R.Li N. Amer. 1829. S co Bot. mag. 3123
"This is a highly ornamental species, and well merits a place in every flower border."
L. grandiflorus. Remarks on this splendid and now well known species will be found, p. 50.

O'ROBUS canescens. A hardy perennial species; most desirable for its "large blossoms, whose colour is a rich purple, becoming more blue when fully expanded." (*Bot. Mag.* 3117.)

O. Fischèri. "A pleasing hardy perennial, 1ft. in height; with slender stem," narrow leaves, and racemes of deep red blossoms produced in May and June. Increased by seeds, and likes light loam. (*Bot. Cab.* 1740., Oct. 1831.)

Leguminosæ § *Cassiæcæ*.

*1269a. CASTANOSPERMUM Cum. MORETON BAY CHESTNUT. (*Castanea*, chestnut; *sperma*, seed; taste.) australe Cum. southern $\frac{1}{2}$ \square fr 40 ... Saf N. Holl. 1828. S l Bot. mis. 51, 52
This tree is thus spoken of in the second part of the *Botanical Miscellany*, in a most interesting article by C. Fraser, entitled "Journal of a Two Months' Residence on the Banks of the Rivers Brisbane and Logan, on the East Coast of New Holland." On July 4. 1828, Messrs. Fraser, Cunning-

Has paler herbage, and paler and larger flowers, than *V. odorata*, which it equals in freedom of growth; its flowers are said to be numerous and fragrant. I have cultivated the plant, and deem it less desirable than *V. odorata*. Plants of the latter, in sheltered situations, have expanded a partial succession of fragrant flowers from Michaelmas till now; but the time for its fullest flowering are the sunny days of April.

CXL. *Caryophyllæa* § *Sileneæ*.

1388. *SILENE* 11480 *maritima*

2 flore pleno double-flwd ♀ Δ rk ½ jlo W England sea sh. S ru

A most eligible plant for furnishing and decorating rockwork. Should its doubleness prevent its increase by seeds, it will, without much difficulty, be multiplicably by cuttings.

11620a *laciniata* Cav. cut-petaled ♀ Δ or 1½ jl S Mexico 1823. S s.l. Bot. reg. 1444

A handsome striking species. "Root perennial; stem decumbent, 1½ ft. long, pubescent; leaves oblong lanceolate, pale green, pubescent; flowers terminal, scarlet," large, and each of the petals 4-cleft. Native of Mexico, consequently not perfectly hardy in Britain, and has hitherto proved to be difficult to cultivate.

Diánthus crenatus (20th) is flowering in a green-house at Messrs. Young's. Their plant is a graceful slender shrub, in height about 2 ft. Its narrow leaves are of a pleasing delicate green, and the petals of the long-tubed flower are white, and crenate in their margin.

CXLVII. *Crassulææ*.

913. *ROCHEA* Dec. The *Laröchea* of Loudon's *Hort. Brit.*, p. 112. should be *Röchea*. Decandolle, in his *Prod.* 3. 393., very properly asks why should *Röchea* be corrupted into *Laröchea*, when the articles are never admitted as part of the name; for example, La Billardière supplies the generic name *Billardièra*, Du Hamel that of *Hamèlia*, &c. To these may be added the name *De Candolle*, from which the genus *Candollea* is derived; *L'Héritier*, *Hcritièra*; *Trochètia*, after *Dutrochet*; *Peyroúsia* after *La Peyrouse*, and so of many others.

Crassula lactea is now (Jan. 15.) blooming beautifully in a frame in the Chelsea Garden, and in a green-house with Mr. Haworth: it is a charming species. *Echevèria coccinea* is in blossom at Young's.

CXLVIII. *Ficoïdææ*.

LEDOCA'RPUM. Relative to this genus, given Vol. VII., p. 345., Mr. David Don, in the *Edinburgh New Philosophical Journal*, Oct. 1831, has, at p. 276, the following remarks:—"It is the genus *Balsisia* of Cavanilles in the *Anales de Ciencias Naturales*, published at Madrid in 1804; and the genus *Ledocárpon* of Desfontaines, published in 1818."

Mr. Brown has shown the genus *Balsisia* of Willdenow to be the same with Linnæus's genus *Tridax*; consequently the law of priority by which *Tridax L.* abrogates *Balsisia Willd.*, causes *Balsisia Cav.* to abrogate the genera *Ledocárpon Desf.* and *Cruikshanksia Hook.* Mr. Don refers this genus *Balsisia* to *Ficoïdææ*, which he considers it connects with the small group *Reaumuricææ*.

DIVISION II. Plants with a Monopetalous Corolla.

LXIX. *Sapôtææ*.

A'CHRAS Sapôta. "Common sapota, or bully tree. One of the largest trees in the mountainous woods of Jamaica. The timber it yields is considered of great service in the making of shingles to corn-houses. The wood is white; the bark is brown, astringent, and commonly known by the name of cortex jamaicensis; being, according to Brown, frequently administered to the negroes in lieu of the jesuit's bark, and found to answer all the purposes of that medicine. The seeds are aperient and diuretic. The tree is a native of the West Indies, Jamaica included; and is cultivated abundantly throughout all the hot parts of South America, for the sake of its fruit, which in appearance somewhat resembles an old and decayed potato, and yet is the most luscious of the West Indian fruits; but so abounds in an acrid milk, that it cannot be eaten until it is completely ripe, or, according to French authors, until it almost begins to be putrid. It is then served at all tables, and generally esteemed." (*Bot. Mag.* 3111, 3112.)

CLXX. *Ericææ* § *vêrææ*.

1173. *ERICA*.

9530a *calóstoma* Lo. C. pretty-mouthed  or 1 myjn F Eng. hybrid? ... C s.p. Bot. cab. 1759

This is usually considered a variety of *ventricosa*, and is probably hybrid between it and some other kind. It is an elegant plant, flowers in May and June, and lasts long in bloom. (*Bot. Cab.*)

Erica triflora. The flowers are white and delicate. (*Bot. Cab.* 1733.)—*Erica cylindrica*. "Its red flowers are produced in May and June in rich profusion: they are particularly splendid, and often form a dense spike 2 ft. in length. It is one of the most vigorous-growing kinds, and should have particularly large pots, and be watered unsparingly; in default of which, it becomes starved, and soon dies. Increased by cuttings. (*Bot. Cab.* 1734.)

E. tróssula rubra. "It is an exceedingly beautiful kind, upright in its growth; the red flowers are produced in the utmost profusion, usually during the months of April and May. (*Bot. Cab.* 1742. Nov. 1831.)

Ericææ § *Rhodoræææ*.

1339. *RHODODE'NDRON*.

11025b* [.....] Carton's *Lindl.*  or 3 jn Li Eng. hybrid 1825. L s.p. Bot. reg. 1449

*Carton's *Rhododendron*. Another of the Highclere hybrids, which Professor Lindley, at the request of J. R. Gowen, Esq. has named after Mr. James Carton, gardener to the Earl of Caernarvon. This is the finest hybrid of a set of hybrids, of which the following is the history given:—"Ninety-seven plants were raised in the Highclere garden, in the year 1825, from a specimen of *Azalea nudiflora*, which had been purposely touched with pollen of *Rhododéndron catawbiense*. They vary in habit, in the size of the umbel, and in the deeper or fainter purple tint of the corolla; but bear a family resemblance to each other, and form very neat compact bushes. The foliage is elegant, lucid, deep green

smooth; and persistent in ordinary winters. In seasons of more than usual severity it becomes deciduous, the flowers in that case being fully expanded before the leaves are much advanced in growth. The leaves are about half the size of those of *Rhododendron catawbiense*, and, like them, are in a considerable portion of the specimens convex, but are much thinner in texture. When they first appear, they are apt to be of a pale, sickly hue, which soon gives place to a healthy colour. The male type predominates in all the specimens. Cuttings of these intermediate varieties strike more readily than those of either *Azalea* or *Rhododendron*. "Carton's *Rhododendron* has a largish umbel of numerous smallish lilac blossoms, and these were produced in June. Seems a very desirable variety. (*Bot. Reg.* 1449. Nov. 1831.)

pulchrum *Siet.* *Smith's beautiful* ■ □ or 3 ap.jl Ro Eng.hybrid 1827. C s.p Sw.fl.gar.2.s.117
All the plants which used to be called azaleas some botanists now call *rhododendrons*; so the *R. pulchrum* above is, in fact, a hybrid from *Azalea indica*, and is the plant called *Rhododendron indicum* γ *Smithii* in *Sweet's Hort. Brit.*, ed. 2. p. 343; and is the *Azalea indica* γ var. *Smithii* of some others. *R. pulchrum* was raised by Mr. Smith of Coumbe Wood, Kingston, from seeds of *Azalea fedifolia*, impregnated, about four years ago, by the pollen of the old red *Azalea indica*. It is a splendid mule, the corollas of which are "very large and handsome, above 2 in. in length, and about 3 in. in width when expanded, and of a bright rosy purple, spotted on the inside with bright red spots." Mr. Smith also raised, at the above time, several other hybrids of this genus, which he expects to blossom next spring.

indicum
var. *ignescens* *Sirt.* fiery ■ □ spl 2 mr.my Bt.C China ... C p.l Sw.fl.gar.2.s.128
"This splendid variety was imported by Mr. Tate. It differs from the old *R. indicum* in being much more branched, with the branches more slender and spreading, instead of upright. The flowers are smaller, but more abundant, and of a brighter crimson.

R. lapponicum is figured in *Bot. Mag.* 5196. It is a floral gem brought from Canada by Mr. Blair in 1825. Flowered at Cunningham's Nursery, at Comely Bank, near Edinburgh, in July, 1830. This evergreen procumbent shrub, whose branches are about 6 in. long, and its dark green ovate leaves four lines long and three broad, "inhabits the alpine ridges of the low grounds in the extreme arctic regions of Europe, Asia, and America. The bruised leaves are fragrant, yielding a smell which Pallas compares to that of turpentine. The flowers are exceedingly beautiful." The corollas are three fourths of an inch across, funnel-shaped, and crimson. Mr. Blair mentions in our Vol. VII. p. 237. finding a solitary plant of this on the White Mountains.

621. AZALEA 4347 nudiflora.
scintillans *Lindl.* sparkling ■ or 4 my.jn O.s Eng.hyb. 1827? L s.p Bot. reg. 1461
Another Highclere hybrid, obtained from seed of *A. coccinea* major, impregnated by the pollen of *A. pontica*: very beautiful. (*Bot. Reg.*)

The genus *Erica* contributes more to the decoration of the green-house at this season than any other genus. Their own peculiar elegance wins for them the high estimation of all; but they seem to bespeak this still more intensely by displaying their loveliness, their beauty, and their elegance, at the present comparatively flowerless season, when Flora's spleen-dispelling smiles are ever doubly welcome.

At Colvill's the following kinds were observed in bloom on Jan 15:—With tubular corols, transparent, viridescens, elata, coidrans, Archèr, pellicida, mutabilis, linnæoides, cerinthoides. With small corollas, gracilis autumnal and vernal, regèrmanus, and tenella. With inflated corols, ardens, vèrnix, vèrnix coccinea, grandiflora with blossoms, as the word implies, seasonably resembling hail-stones, Lambèrt, pyramidalis, and ramentacea. In this nursery was then also blooming, the Enkiânthus quinquiflorus; one of its clusters, however, consisted of at least seven flowers. The flowers themselves are exquisite pendulous flesh-coloured bells, each large enough to admit the extremity of the little finger, and in the base of which are five largish cavities (in the manner of *Cyclobóthra* somewhat), all filled to overflowing with a sweet nectareous fluid.

At Young's are many heaths in blossom, and one without a name, powerfully fragrant like the flowers of hawthorn, but more agreeable: its flowers are small and numerous. The following kinds were blooming here (Jan. 20.); but want of time prevented them, and also subsequently, their distribution into sections as above:—

<i>Erica plumbea</i>	<i>Erica discolor</i>	<i>Erica pubescens</i>
<i>gracilis vèrna</i>	<i>corifolia</i>	<i>cupressina</i> <i>Sal.</i>
<i>Linneæa</i>	<i>ventricosa</i> of Andrews's	<i>rubida</i> <i>Lod.</i>
<i>ignescens</i>	fig. not of the gardens	<i>hirtiflora</i> <i>Sims.</i>
<i>socciflora</i>	<i>pratensis</i>	<i>laxa</i>
<i>elongata</i>	<i>Sebàna lutea</i>	<i>rubens</i>
<i>vestita purpurea</i>	<i>cærnea</i> (hardy)	<i>arbuscula</i>
<i>aspera</i>	<i>coccinea</i>	<i>hirta</i> <i>And.</i>
<i>echiniflora</i>	<i>sparsa</i>	<i>pellucida</i> <i>And.</i>
<i>penicillata</i>	<i>refulgens</i> <i>And.</i>	<i>midularia</i>
<i>ardens</i>	<i>Cushiniana</i> <i>Lee</i>	

CLXXII. *Vacciniæ.*

1194. VACCINIUM.
humifusum *Grab.* earth-spread 2. el 4 my W Rocky mo. 1827. L p *Edin. n. phil.* [Journ. 1831. 193
An interesting species, resembling in habit *Mitchella repens*: it likes dry open borders, and produces a very fine-flavoured fruit, called in America the edible cherry, but has hitherto flowered very sparingly in the Edinburgh and Glasgow Botanic Gardens. Sent home by Mr. Drummond.

Of the greater or American cranberry, *Oxycoccus macrocarpus* (*Vaccinium macrocarpum* that was), there exists in Knight's Nursery, and in some other collections, a variety with its leaves prettily variegated: this should be sought after by the curious cultivator.

CLXXIV. *Campanulæccæ.*

1177. MICHAUZIA.
† *laevigata* *Ven.* smooth ♀ □ or 11 au.o W N. Persia 1820. S r.l Bot. mag. 3128
Every part of the plant yields, on the slightest injury, a large quantity of milky juice; a characteristic

of the order Campanulææ, to which it belongs. The height to which the flower stem attained, eleven feet, is most remarkable: the plant grew in the open border. — See other remarks on this order in Vol. VII. p. 101.

CLXXV. *Lobeliiææ*.

609. LOBELIA.

- robusta *Fis.* robust \square or ... au P Hayti 1830. D s.l *Jam. jo.* 1831. 378
 5103a [speciosa *Hort.*] Low's showy \sphericalangle \triangle or 2 my.o P Scotch hyb. 1830. D p.l Bot. reg. 1445
 The latter is perhaps perfectly hardy, and produces its beautiful deep lilac (purple, as some would call them) blossoms from May to October. A desirable plant, and easy of cultivation. It is presumed to have been originated between *L. syphilitica* and either *fulgens*, *cardinalis*, or *splendens*.

CLXXVI. *Styliidææ*.

2581. STYLIIDIUM.

- 22828 fasciculatum *R.Br.* bundled \sphericalangle \square pr $\frac{1}{2}$ au Pk New Holl. 1830. S s.p Bot. reg. 1459
 Raised at Mr. Knight's Exotic Nursery, from seeds introduced by Mr. Baxter, and may prove hardier than marked above: it is an eligible plant for decorating the hardy flower-garden during summer.

scandens climbing \sphericalangle \square or 1 $\frac{1}{2}$ n. Pk KgGoSd. 1830² C p *Brown Prod* 570
 "The flowers of this very pretty species were slowly developed, remained long expanded, and appeared on one raceme in succession during the whole month of November. Other racemes are now (Dec. 10. 1831) beginning to appear; so that I doubt not the plant will be a great ornament to the greenhouse during the whole winter." (*Graham in Edin. Phil. Jour.* 1832, p. 187.)

CLXXXIII. *Plumbagiææ*.

929. STAPTICE.

- 7506a puberula *Webb* downy-leaved \sphericalangle \square cu $\frac{2}{3}$ my V.v l. Graciosa 1830. S eo Bot. reg. 1450
 "Apparently near *S. furfuracea* of La Gasca." The calyx is of a violet colour, the corolla white.
acerosa Bieb. needle-pointed \sphericalangle \square cu $\frac{1}{2}$ jn. j. Pa. Pk M. Ararat 1829. S l.p Bux. c. 2. 18. 10

CLXXXVI. *Compósitæ* § *Labiatifloræ*.

- *2448a. CENTROCLINIUM *D. Don.* (*Kentron*, sharp point, *klinē*, bed.) 19. 2. *Compósitæ Labiatifloræ*.
reflexum Hook. reflexed-scaled \square or 2 au Ro Peru 1830. S lt Bot. mag. 3114
Onoseris salicifolia of *Hum. & Kth.* is thought to be near akin to this.

apressum *Hook.* appressed-scaled \sphericalangle \square 2 jn Ro Peru 1830. S lt Bot. mag. 3115
 "Differs from *C. albicans* *D. Don.* in its entire leaves; and from *Onoseris angustifolia* *Hum. & Kth.* in its larger and broader foliage."

A Peruvian genus of syngenesious plants, with rosy marginal florets. Very interesting plants to botanists, but scarcely sufficiently ornamental for those who regard flowers only for their splendour. The blossoms produced in autumn are endowed with a high degree of hawthorn-like fragrance.

Compósitæ § *Fernoniææ*.

9262. VERNONIA.

- 20475a axilliflora *Lessing*' axil-flwd \sphericalangle \square or 1 $\frac{1}{2}$ all sea Li Bahia C s.l Bot. reg. 1464
 "Beautiful; flowers all the year, and is propagated with the greatest facility from cuttings, which will blossom when only a few inches high."

Compósitæ § *Astérææ*.

- 2337a. HAXTONIA *Caley.* (*John Haxton*, gardener attached to Macartney's expedition to China.) *Comp. argophylla Caley*
Aster argophyllus Lab. Mr. David Don describes and defines this genus, *Haxtonia*, in the *Edinburgh New Philosophical Journal*, Oct. 1831, p. 272., and refers to it the *Aster argophyllus Lab.*, *viscosus Lab.*, *phlogopappus Lab.*, *stellatus Lab.*, and *tomentosus Willd.* and *Hort. Kew.*

Compósitæ § *Helianthææ*.

2331. MADIA.

- 21057 elegans *D. Don* elegant \circ or 1 $\frac{1}{2}$ aut Y N.W. Amer. 1831. S co Bot. reg. 1458
 New, but neither elegant nor beautiful, except in comparison with other known *madias*. One Chilean species of *Madia* is famous for the oil expressed from its seeds. *M. elegans* was sent home by Douglas, to the Horticultural Society.

9412. GAILLARDIA, spelled GALARDIA in *Loudon's Hort. Brit.* p. 358. This error Professor Lindley corrects in the *Botanical Register*, vol. 14. t. 1186, published Oct. 1. 1828, in these words, "Botanists usually write this word *Galardia*, an obvious inaccuracy [as it is named after M. Gaillard], the origin of which is said by M. Cassini to be chargeable upon Lamarck."

2963. GEORGINA 21591 superflua

Blood red anemone-flowered variety, Maund's *Botanic Garden*, 297.
 Painted lady anemone-flowered variety, Maund's *Botanic Garden*, 320.
 Georginas "enrich autumn with a splendour which rivals June, with its pyramids of roses and mid-summer gaieties." — *Maund*.

Among georginas two varieties of great interest are expected to be much in request in the ensuing spring; one, the King of the Whites, was imported in 1830, and has excellent properties; the principal of which are, the purity of its white, and the earliness and abundance of its blossoms, which are well displayed above the herbage: its height is about 4 ft. The 2d (raised in 1830) is Miss Wright, so denominated in compliment to the American authoress of this name by the Conductor, who was requested to name the flower by the possessor of the stock, Mr. Michael Brewer, Cambridge, who raised the Cambridge Surprise. The Miss Wright georgina is a delicate and distinct flower, of medium size, possessing considerable depth and fulness of petals, which are elegantly quilled, and of an exquisite rose colour. Some interesting facts on the variability of georginas from seeds are stated in p. 47.; and though the amount

of these remarks is possibly familiar to every grower of georginas, a record of actual cases is valuable, as furnishing data for subsequent and ultimate inferences.

In Composite, only the following have, within the writer's recent observation, been observed in blossom: — *Cineraria cruenta* (for able directions for cultivating this beautiful plant with success see Vol. II. p. 153.); *Naja gracilis*, which is really an interesting plant; *Agathæa amelloides*, but which seems scarcely in season; and *Pyræthrum grandiflorum*. *Calendula graminifolia*, at Young's, will be in bloom in a week or so; its blossoms are very showy. *Phœnocomia prolifera* here and there displays a ruby head. In the open air, in sheltered spots, one beneath a house wall in a town garden, *Tusilago fragrans*, displays its flowers in numerous racemes: these are not conspicuous, but elegant on close inspection, and for their fragrance past all praise.

CXCI. *Caprifoliaceæ.*

621. CAPRIFOLIUM.

23106a occidentale Lindl. western $\frac{3}{4}$ or 20 in. au O Ft. Vancouver 1824. C co Bot. reg. 1457
Resembles the common honeysuckle, but is not so hardy. It has very ornamental orange-coloured flowers, but not good foliage; is near akin to *C. ciliosum*, Douglas's, and *parviflorum*. (*Bot. Reg.*)

hirsutum Dens. hairy-leaved $\frac{3}{4}$ or 20 my. in Y Canada 1822 C co Bot. mag. 3103
Lonicera hirsuta Eaton in his *Manual of Botany*, Hooker in *Curt. Bot. Mag.*, 3103. *Caprifolium pubescens* of Loudon's *Hort. Brit.*, No. 5213., and of Hooker's *Exotic Flora*, 27.; but Dr. Hooker having since learned that Mr. Eaton, an American botanist, was the first to publish this species, and by the name of *Lonicera hirsuta*, in his *Manual of Botany*, now thinks it right to reinstate Eaton's name. Perhaps Dr. Hooker, by retaining the plant under *Lonicera*, does not acknowledge the genus *Caprifolium*.

Fibrum Tinus is now partially in blossom every where. *F. rugosum* is trained to the front of a green house, outside, at Colvill's, and retains its foliage well, but the leaves are not the prettiest. Ivy, "green and shining," looks every where refreshingly.

CC. *Polemoniaceæ.*

472. PHLOX.

3922a aristata B. C. awned $\frac{2}{3}$ Δ pr $\frac{1}{2}$ ap W Carolina ... C pl Bot. cab. 1731
A species with almost the foliage and habit of *P. setacea*, and with blossoms apparently white, and resembling somewhat those of *P. nivâlis*. If this be the *P. aristata* of Michaux, it proves the latter to be distinct enough from *P. pilosa* Bot. Mag., with which *P. aristata* has been thought identical.

CCVII. *Primulaceæ.*

PRIMULA ciliata. Corollas pale flesh-coloured. A light loam suits it well, and the plant is readily increased by parting. It is admirably adapted for rockwork, where its showy and early blossoms, it being one of the earliest of the auricula tribe, cannot fail to attract notice in the spring. Drawn from Colvill's. (*Sud. Fl. Gar.* 2. s. 123.)

Primula prænitens, lilac and white, is in bloom wherever kept. This comparatively hardy (it will thrive thoroughly in a well-aspected frame), freely growing, abundantly blooming species is an important importation, far more so than those unique plants which are with difficulty kept alive, and still more difficultly cultivated: hence the value of the Horticultural Society's introductions, through the agency of Mr. Douglas. *Primula Palindri* is (Jan. 15.) in bloom in a green-house at Colvill's. *Cyclamen ebum* and *vernum* are in bloom about in pits and frames; and of *C. persicum fragrans* saw a plant in blossom at Dennis's, and one at Young's.

CCXI. *Scrophularinæ.*

65. CALCEOLARIA.

578a [Young's Hort.] Young's hybrid $\frac{1}{2}$ Δ spl 3 my. o OchSpotEng. hybrid 1830. D r m Bot. reg. 1448
On this remarkably splendid hybrid, and on other hybrid calceolarias, some remarks are offered, p. 48.

C. plantaginea. "Flourishes in a strong red loam and cool situation, and yields a plentiful increase by offsets." *Bot. Gard.* 328., Oct. 1831.)

C. arachnoidea. This has been proved nearly hardy in various gardens, and is a native of high elevations in Chile. There "many people are employed in digging up the roots, which they dry and collect in bundles for sale, the plant being in great use there, for dyeing woollen cloths of a deep crimson colour. The alum earth employed as a mordant in the process is obtained in abundance from a mountain in the neighbourhood." (*Bot. Reg.* 1454, Nov. 1831.)

*1783a. LEUCOCARPUS D. Don. LEUCOCARPUS. (*Leukos*, white, and *karpos*, fruit.) 14. 2. *Scrophularinæ.*
alatus D. Don. winged-stalked \circ ? cu \circ o Y Vera Cruz 1830. S pl Sw. fl. gar. 2. s. 124
Conbeea alata Graham, *Mimulus perfoliatus* Bot. Mag. 3076.

Agrees so entirely with *Mimulus*, both in general appearance and in the form and structure of its flowers, that, without the fruit, no one can doubt the propriety of referring it to that genus; but its white berries being once seen, it will be evident that the plant can neither be referred to *Mimulus* nor "to any other genus hitherto established among the *Scrophularinæ*." Expected to prove hardy. Published from Whitley and Co.'s, Fulham.

1787. TORENIA.

scabra Grah. rough leaved \circ pr 1 ... P Moreton Bay 1830. S p Bot. mag. 3104
It has opposite, lanceolate, green, serrate leaves, and its blue blossoms are funnel-shaped, and an inch in length.

PENSTEMON pulchellus. It was asserted in the *Botanical Register*, t. 1309., that seeds of the rare penstemons cannot be raised in heat. Part of the remark is in these words: — "It is indispensable that the seeds should be sown in a cold frame, or all endeavour to raise them will prove fruitless." Mr. Maund, in figuring *P. pulchellus*, remarks, that, to prove or disprove this assertion, he sowed seeds in a pot, and placed them "in a rather warm hotbed," where many seeds vegetated freely; and the plants so raised flowered well in the autumn. [Sowing them in a cold frame is, notwithstanding, doubtless preferable, as being more congenial to the natural mode. In natural dissemination, seeds are sown as soon as ripe; in gardening, they are often kept out of the soil until their vital energy is considerably weakened, and then artificial stimuli may be necessary to rouse it into action.]

CCXIII. *Solanææ* § with a capsular Pericarp.

1714. SALPIGLO'SSIS.

integrifolia Hook. entire-leaved \bigcirc \square or 1 jl Ro.P Uruguay 1831. S lt Bot. mag. 3113
Its corollas are broadly funnel-shaped, the tube dark bluish purple, the lobes of the border of a rich crimson purple; handsome, and very distinct from the previously cultivated Salpiglósses. Dr. Hooker possesses another new species, which he denominates *S. lineàris*.

lineàris Hook. linear-leaved \bigcirc \square or 1 jl ... Uruguay 1831. S lt Bot. mag. 3113

On p. 47. we have presented a remark from Dr. Graham on the sportiveness of the Salpiglósses; and in the Report of the Stirling Horticultural Society, p. 124, mention will be found of four hybrid Salpiglósses that were exhibited from the garden at Callander Park.

*490a. ? NIEREMBERGIA Kth. NIEREM. (*J. E. Nieremberg*, author of a History of Nature.) 5. 1.

linariæfolia Grah. Toadflax-lyd \bigcirc ? \square el $\frac{1}{2}$ jl Wsh Uruguay 1830. S p? Bot. mag. 3108

An elegant slender plant, expected to thrive in our open gardens in summer, with stems 6 to 8 in. high, leaves narrowly linear and pubescent, and very singular blossoms. The latter have an extremely slender tube, an inch in length, surmounted by a salver-shaped broadly-spread border, 5-lobed, white, streaked with purple, having a yellow eye where it is inserted on the tube. From the sides of the Uruguay, near Buenos Ayres. Flowered in July, 1831. Three other species are known, *N. repens*, growing in Peru; *N. angustifolia*, in Mexico; *N. pubescens*, on Monte Video.

Dr. Hooker publishes this plant as *N. grácilis*, but makes no allusion to a species described in minute detail by his friend, Professor Graham, in Jameson's *Journal*, 1831, p. 378., under the name of *N. linariæfolia*. Mr. D. Don has not a doubt that both writers have the same plant in view; so, as Professor Graham's name was first published, it is here adopted.

. In this order the prettiest plant observed in blossom is *Brunfelsia uniflora* (*Franciscæa Hopedæna* of exploded nomenclature), and this at Messrs. Young's (Jan. 20.), when beautiful it was, its recently opened tubular corols being exquisitely fragrant, and their comparatively wide-spread orbicular border of a snow white, or appearing to be so, from the advantageous contrast of the recent flowers with the older ones of a deep lilac hue displayed beside them. The plant was growing in a propagating house in a bed of soil partly loamy, into which its branches were inlaid, and in this position were blooming. In the Kensington Gardens conservatory (which includes a multitude of species, especially of old ones), *Solanum Pseudocapsicum* (the *Capsicum Ammum* Plinij of the Parisians) was beautiful just after Christmas, from the elegant contrast of its glossy bright-hued berries, closely resembling miniature oranges, with the dark green foliage of the neighbouring plants.

CCXX. *Verbenæcæ*.

1738. LANTANA 15565 nivea

mutabilis Hook. changeable-hued \square or 5 myjn Y.Ro C lp Bot. mag. 3110

Has the habit of *L. nivea*; but instead of heads of elegant flowers of a snowy white colour, as in that kind, those of this variety (*mutabilis*) are "at first yellow with an orange eye, then becoming rose-coloured with an orange eye, finally entirely rose-coloured:" the blossoms are produced in May and June, and continue for a considerable length of time. A very desirable plant.

The *Gardoquia origanoides* of Reichenbach is a species of *Lantana*. (*Benth.*)

1749. VERBENA.

15631a *venosa* Gill & Hook. strong-veined $\text{£} \triangle$ or $2\frac{1}{2}$ su Ro Bu. Ayres 1830. S sl Bot. mag. 3127

"A very handsome species, in many respects allied to *V. bonariensis*, differing in its much shorter spikes, and vastly larger flowers, which are of a bright purple [rosy] colour."

Lippia dulcis whose leaves are sweeter than sugar, of which property the specific name is expressive, at Young's, was going out of flower; but this mention of it enables me to impart a ray of systematic knowledge communicated by Mr. Penny: the *Lantana lavandulæfolia* of Loddiges's *Bot. Cab. 1773.* is *Lippia dulcis* of Loudon's *Hort. Brit.* p. 454.

CCXXI *Labiatæ* § *Nepetéæ*.

*1682a. GARDOQUIA R. & P GARDOQUIA. (*D. Diego Gardoqui*, a noble Spaniard.) *Labiatæ* [Oct. 1831. p. 377

Gilliesii Grah. Gillies's $\text{£} \triangle$... 2 ... Li Chile 1828. S ... Jameson's *jour.*

discolor Kth. two-coloured $\text{£} \square$... ap.jl P Caraccas 1827. S ... *Sw. h. brit.* 2. 409

G. origanoides of Reichenbach in Sprengel's *Addenda*, and therefore also of *Sweet's Hort. Brit.* ed. 2. p. 409., is according to Bentham in *Bot. Reg.* 1800., a species of *Lantana*.

1693. SCUTELLARIA.

15284a *variegata* Hort. variegated-fld $\text{£} \triangle$ pr $\frac{1}{2}$ au P.v Switzerl. ... D pl Bot. reg. 1460

Scutellaria variegata Hort.

Mr. Lindley figures this pretty plant as the *S. alpina* of Linnæus: it looks very unlike, indeed, the plant of Linnæus; wherefore the name *variegata*, applied by the nurserymen, is here retained.

In this order, the most interesting plants in flower since the 15th are *Pogostemon plectranthoides*? and *Plectranthus carnobus*. The *Pogostemon* is in a stove at Chelsea, and is presumed to be *plectranthoides*. Its corols are small and of a grey blue, so unshowy; but its filaments are, as the word *Pogostemon* implies, bearded with hairs, in the manner, but more sparingly, of the filaments of *Tradescantia virginica*, but seem not articulated in the same manner of matchless elegance. The herbage of *P. plectranthoides* has an aromatic odour. *Plectranthus carnobus* is at Young's: its flowers also are small, grey blue, and unshowy; but this defect, if defect it be, is compensated by the odour of the fleshy, rigid, pubescent leaves; which, on contact, supply an odour more grateful than describable, and assimilating to that of *O'cymum gratissimum*.

*76a. AUDIBERTIA Benth. AUDIBERTIA. (*M. Audibert*, of Tarascon, nurseryman.) 2. 1. *Labiatæ*.

incana Benth. hoary £ cu $1\frac{1}{2}$ jls Pa.B Colombia 1827. S co Bot. reg. 1469

Sálvia carnosa Herb. Dougl.

Differs from *Sálvia* in habit, form of corolla, and in its anthers; the connectivums of which are hot

produced below the point of insertion, but merely articulated on the filament. Mr. Bentham finds the genus he had in *Bot. Reg.* t. 1282, denominated *Audibertia* untenable, so transfers the name to the present plant.

SUBCLASS II.

Plants with Endogenous Growth and Monocotyledonous Seed.

CCXXXVIII. *Amaryllidæ*.975. *HABRANTHUS*.

pálidus B. C. pale-flowered ♂ Δ or 1 jn Pk Valparaiso 1830. O r.m Bot. cab. 1760

Among the bulbs were some with flowers ranging between white and red, from which we may infer that *H. pálidus* is a cultivated plant. *Bot. cab.*

970. *PHYCELLA*.

8006a *gláuca* B. C. glaucous-*lvd* ♂ Δ or 1 jn R Valparaiso 1824. O l.p Bot. cab. 1745

P. ignea var. *gláuca* *Bot. mag.* 2687.

8006 *ignea*

♀ *púchra* D. Don pretty ♂ Δ or 1½ o R Valparaiso ... O r.m Sw.fl.gar.2.s.121
Ornamental in the umbel of pendulous, red, tubular blossoms. Figured from the Chelsea Botanic Garden, and some varieties near the above are at Knight's Exotic Nursery.

965. *CYRTANTHUS*.

7868a *cárcnea* Lindl. flesh-coloured ♂ Δ or 1 au F C. G. H. ... O r.m Bot. reg. 1462

The crown of long, pendulous, flesh-coloured, tubular corols is very ornamental.

938. *CALOSTEMMA*.

Cunninghámii Ait. Cunningham's ♂ Δ or 1 sp W N. Holl. 1826. O s.l

979. *ALSTRÆMERIA*.

28162a Neill's Gail. Neill's ♂ Δ cl 2 jn Pa.Ro Mendoza 1827. O 1p Bot. mag. 3105

A very pretty species, near *A. pálida*, named after the celebrated Patrick Neill, Esq., of Canonmills, near Edinburgh, where and with whom it bloomed in the green-house, in June, 1831. Native of both sides of the Cordillera of the Andes, between Chile and Mendoza. Stem upright, bearing highly glaucous leaves, and an umbel of from six to eight flowers of a pale rose colour. Dr. Graham furnishes the description of this species, and remarks:—"Mr. Neill's very interesting garden has recently sustained a great loss in the removal of the gardener, Alexander Scott, whose professional talent and patient industry have been transferred to a situation of more extensive usefulness. He has been appointed foreman to Mr. Knight's Exotic Nursery, Chelsea; a situation for which he is especially fitted by his quiet unassuming manners and uniformly steady conduct."

Upwards of a hundred beautiful, and some of them splendid, and many of them newly originated, hybrid kinds of *Amaryllis*, are now (Jan. 17.) blooming at Colvill's. Of *A. állica* *platypétala* two most vigorous specimens have blossomed; one is still flowering; the other is past, and exhibits finely swollen gemmens, which have been artificially impregnated with pollen of *A. reticulata*: from the union of these two fine kinds, hybrids of high interest are anticipated. *Crinum amabile* here exhibits the last flowers of an extremely fine umbel; and *C. australe* is in blossom. Rather many seedlings of *alstræmerias*, from seeds purchased of Mr. Cumming, are already above ground. Forced specimens of a double-flowered polyanth-narcissus are finely in blossom: this is possibly the *Hermione Cypri* v. *plena* of Haworth's excellent *Narcissinearum Monographia*.

CCXXXIX. *Iridæ*.3281. *STREPTANTHUS*.

2807a *cárcnea* Swt. copper-eld ♂ Δ or 2 jn,jl Cop C. G. H. 1825. O p.l Sw.fl.gar.2.s.122

♂ Stigma three-cleft, the segments broadly dilated at the ends, deeply channeled on the upper side, having the appearance of two lobes; the edges beautifully fringed, so as to give it, with its hollow surface, the exact resemblance of a leaf of *Dianæa muscipula*: has it not the same uses? Drawn from Mr. Colvill's.

128. *GLADIOLUS*.

1187b *natalensis* Reinwardt Natal ♂ Δ spl 4 jl,au Sv Natal 1830. O p.l Bot. cab. 1756

This bore the winter perfectly well out of doors, in front of our stove, in sandy peat soil, and appears to increase itself freely by offsets. (*Lochtges's Bot. Cab.*) This new and very splendid species has been also recently published in the *Botanical Register*, 1412, but under the abrogated name of *G. psittacinus*; the editor having perhaps overlooked the note at t. 3084 of *Bot. Mag.*, in which Dr. Hooker shows that *natalensis* is the legitimate name of the species. Stem 3 to 4 ft. high, well furnished with leaves, and terminated by a spike, a foot in length, of large blossoms, yellow-spotted, striped, and margined with scarlet. "The colours are indeed splendid beyond anything that can be expressed, except by the most elaborate miniature painting." Published in *Bot. Reg.* from the nurseries of Mr. Lee of Hammersmith, where it blossomed in July last; and from that of Mr. Miller of Bristol, with whom it blossomed strongly at nearly the same time.

Potted crocuses in frames are showing blossom at Colvill's; and in the open air, in Mr. Haworth's interesting little garden, *Crocus pávilus* is (Jan. 24.) in blossom.

CCXL. *Orchidæ* & *Ophrydæ*.2481. *ORCHIS*.

fuscicæns B. C. drying brown ♂ Δ cu ½ jn Ysh Pensylv. 1831. O p.lt Bot. cab. 1748

Int. relating to the botanist only. It is a native of grassy hills in Pennsylvania and of Siberia; bloomed here this year in June, "kept in a cold frame, and potted in peat and vegetable earth." (*Bot. Cab.*)

Orchidæ & *Vándere*

*2500a. *PERISTERIA* Hook. DOVE FLOWER. (*Peristera*, a dove, which its column resembles.) 20. 1. *Orchidæ*.
cláta Hook. lofty ♂ Δ or 4 su Ysh.W Parana 1826. D p.r Bot. mag. 3116

"Bulb as large as a swan's egg, bearing green sword-shaped leaves, nearly a yard long and six inches broad. The flower-stem springs from the base of the bulb; is four feet high; and bears at its extremity a raceme a foot in length of large, yellowish white, almost globose, fleshy flowers, yielding a peculiar fragrance, which somewhat resembles that of the English Nuphar lutea. In Panama, the plant is called El Spirito Santo (the Holy Spirit), and its blossoms show why: the centre of the flower exhibits a column which, with its summit or anther, and the projecting gland of the pollen masses, together with the almost erect wings, bears a striking resemblance to a dove, the emblem of the third person in the Trinity. El Spirito Santo was therefore applied by the same people, and in the same religious feeling, as dictated the naming of the Passion Flower.

3412. CERATOPHYLUS.

oculatus L. C. eyed £ ☒ or 1 jn Y.spot Xalapa 1829. D p.r Bot. cab. 1764

The flowers are pendulous, curiously formed, fragrant, and sprinkled over with innumerable spots, most of which are annular. Near the base of the lip are two very large ones, like eyes, which add greatly to the elegance of the flower.

2563. SARCANTHUS.

guttatus Lindl. £ ☒ el 1 ap W.V.Ro Dacca 1818. D p.r.w Bot. reg. 1443

Acrides guttatum Roxb. MSS.

A lovely epiphyte, with a stem a foot or more in length; depending in its native habitat, the vicinity of Dacca, from the branches of trees; but in the Chiswick Garden "is cultivated in the stove, in a very hot damp atmosphere, in a pot full of moss, suspended from the roof by a wire, and a little overshadowed by climbing and other plants;" thus treated, it flowers in April. Leaves a foot in length, channeled; but, when spread flat, an inch broad; of a shining green. Racemes longer than the leaves, drooping, solitary. Flowers numerous, approximate, pretty large; colour, a beautiful mixture of red and white spotted.

2540. ONCIDIUM.

bicornatum Hook. two-horned £ ☒ el 1 jn Y.Br Brazil 1830. D p.r.w Bot. mag. 3109

A very beautiful Brazilian species, whose slender scape, scarcely longer than the leaves, is surmounted by a large and dense panicle of showy flowers, their ground colour being deep yellow, which is striped, mottled, and spotted with purple red.

O. pumilum. Its blossoms, marked with various colours, are minute, but very numerous, and, when closely inspected, highly pleasing. (Bot. Cab. 1732., Oct. 1831.)

*2530a. CORYANTHES Hook. HELMET-FLOWER. (Korys, helmet, anthos, flower; shape of appendage to lip.)

maculata Hook spotted-lipped £ ☒ spl 1 ½ jn Y.P Demerara 1829. D p.r.w Bot. mag. 3102

The Coryanthes maculata of Hooker is a superb stove orchideous plant, newly introduced from the forests of Demerara, where it grows on the trunks of trees: it blossomed in June, 1831, in the Liverpool Botanic Garden. "Bulbs clustered, scape 1 ½ ft. long, pendulous from the weight of the numerous, very large, blossoms; of these, the petals are of a pale ochraceous yellow colour, the lip and its appendage more inclining to yellow, the latter, which is large and shaped like a helmet, tinged at the margin, and spotted inside with purple." Each bulb (or pseudo-bulb Lindl.) is two-leaved.

Dr. Hooker refers to this genus also the Gongora speciosa Hook. Bot. Mag. 2755., and Gongora macrantha Hook. Bot. Miscellany, 80.; but, as to the name of this genus, Coryanthes, seems to have overlooked its inadmissible nearness to the orchideous genus Corysanthes of Brown: if so, it is a notable instance of an appropriation of the same idea and terms by which to express it, by two men unaware of each other's intentions: an almost parallel instance obtains in Necker's euphorbiaceous genus Pedilanthus, which Mr. Haworth had simultaneously or previously in MS. distinguished and denominated Crepidaria; Necker choosing Greek, and Mr. Haworth Latin, to express the slipper-like shape of the involucre.

Orchideæ & Epidendrea.

2562. BRASAVOLA.

nodosa Lindl. knotty £ ☐ fra 1 o Ysh.G Mexico 1828. D p.r Bot. reg. 1465

Fills the woods at night with its fragrance; grows freely in a hot damp stove, among moss, in decayed vegetable matter."

Orchideæ & Malaxidæ.

2575. MICROSTYLIS.

versicolor Lindl. changeable £ ☒ cu 1 jn.o O China 1830. D p.r Bot. cab. 1751

2539. PLEUROTHA/LIS.

Lanceana L. C. C. Llanes' £ ☒ cu ½ au Y.G Surinam 1831. D p.r Bot. cab. 1767

Liparis proichilus B. C.

In Orchideæ, the following are promising to flower, some of them strongly, in a stove at Colvill's, under Mr. Riath's skilful management: — Oncidium altissimum, Ibridium and carthaginense; Bonatea speciosa, Cyripedium vespertinum, Eulophia gracilis, and Pholidota jamaicensis. Epidendrum cochlearium is in blossom; and Neottia speciosa shows flowers, and is already beautiful in its conspicuous spike of red and sheathing bracteas. At Young's, Spiranthes procera is (Jan. 20.) in blossom. At Malcolm's (Jan. 10.), in a cold damp green-house, Goodyera discolor was thriving perfectly; and its delicate white blossoms, produced in spikes 6 in. long, contrasted pleasingly with its dark-hued leaves; beside it stood the G. tessellata with its foliage so elegantly variegated. Late in November last, Cattleya labiata flowered finely with Mr. Campbell at the Comte de Vandes's. How exquisitely elegant is this species! Cyripedium insigne flowered there also early in December.

On the propagation of the stove Orchideæ some remarks occur in the present Number, p. 88., and it will be here in place to remark the peculiar manner in which some plants of this order are grouped at Colvill's. A crooked trunk of an oak tree rises from the floor and is fastened to the rafters of the roof, and to this are affixed, with nails, the husks of cocoa-nut shells, so thickly, as completely to hide the oaken trunk: the interstices between the nut-shells are filled with soil and moss, in which the orchideous epiphytes are planted.

which a second and similar species is said to be passing, nevertheless, at present under the same name; *Barleria flava*, whose style and stigma are protruded before the corolla is expanded; *Justicia picta*, calycotricha, and speciosa; *Eranthemum pulchellum*, *Ruellia brazilla*, and *Thunbergia coccinea*.

In *Bytneriæceæ*, the *Astrape*'s *Wallichii*, magnificent in its foliage and large depending umbels of orange and scarlet tubular blossoms, is flowering at the Chelsea Botanic Garden, and more abundantly at Colvill's, and at the Comte de Vandres's. In *Myrsinææ*, *Ardisia paniculata* is flowering at Young's; *A. crenulata* is splendid in some stoves, with umbels of glossy bright red berries; and *A. pyramidata* with its red berries, and *A. littoralis* with its almost black ones, are looking prettily at Colvill's. In *Bromeliæceæ*, *Billbergia amœna* has displayed its pleasing violet-tinted flowers, in various collections, through December and the early part of January, but now is past. A scarlet *Pitcairnia*, perhaps staminea, is in flower at Colvill's. In *Marantæceæ*, *Canna versicolor* has for a month or more been, and still is, flowering in the stove in Chelsea Garden. It has large discolorate leaves, a stem from 8 to 10 ft. high, which produces, from near its summit, successive spikes of showy scarlet flowers. In *Commelinææ*, *Aneilæma sinica* is in flower at Young's; where *Filices*, or ferns, are prettily in fruit.

The Flowers of Spring.— These will shortly delight us with their welcome presence, and for them we all feel a deep interest. This is warranted in their earliness and comparative scarcity, and in the countless pleasures of hope to which they excite. On the floral splendour which may be produced from a copious multiplication and contrasted interspersation of the winter acouite, the three kinds of snowdrop (the single, the double, and the plaited), and the numerous kinds of vernal crocus, some remarks have been already offered (Vol. VII. p. 564.). To these will follow the rare but charming snowflake (*Leucobium vernum*), polyanthus, primroses, violets, anemones, *Ficaria verna*, *verna plena*, and *verna alba*; the gorgeous *Adonis vernalis*; the sprightly hepaticas in their varieties of white, blue, and red, and single and double; the Persian iris; and then the fragrant and beautiful narcissus, of which the British gardens boast more than a hundred kinds. In praise of vernal blooming bulbs too much cannot be said; and for their perfectly successful culture but three things are requisite— a soil not over stiff, a site not over bleak, and absolute exemption from disturbance while in a growing state.

Thoughts on Flowers.— "Are not," asks the author of *Atherton*, "flowers the stars of earth, and are not stars the flowers of heaven? Flowers are the teachers of gentle thoughts, promoters of kindly emotion. One cannot look closely at the structure of a flower without loving it. They are emblems and manifestations of God's love to the creation, and they are the means and ministrations of man's love to his fellow-creatures; for they first awaken in the mind a sense of the beautiful and the good. Light is beautiful and good: but on its undivided beauty, and on the glorious intensity of its full strength, man cannot gaze; he can comprehend it best when prismatically separated, and dispersed in the many-coloured beauty of flowers; and thus he reads the elements of beauty, the alphabet of visible gracefulness. The very utility of flowers is their excellence and great beauty; for, by having a delightfulness in their very form and colour, they lead us to thoughts of generosity and moral beauty detached from, and superior to, all selfishness: so that they are pretty lessons in Nature's book of instruction, teaching man that he liveth not by bread or for bread alone, but that he hath another than an animal life." (A Chapter on Flowers, in the *Amulet* for 1832.)

Seasonable Hints on Floriculture.— Seeds of such flowering plants as have spindle-shaped roots, or require to have attained considerable growth and vigour before they can blossom satisfactorily, should be sown in the first open weather. The frosts which will occur after they have germinated will destroy a much smaller proportion of the young plants than may be commonly supposed. Hence, the most proper period of sowing seeds of plants of the above description is the autumn, as soon as the seeds are perfectly ripe. Nature teaches us this rule by the healthful and vigorous plants which almost invariably arise from seeds naturally sown. Those, however, who did not sow in autumn will now do well to commit to the soil, with as little delay as possible, seeds of ranunculaceous plants, as *Adonis*, larkspurs, pæonies, columbines; of papaveraceous plants, as poppies, *Eschscholtzia californica*, *Rœmèria hybrida*, glauciums; fumariaceous plants, as *Adlœmia cirrhosa*, *Corydalis glauca*; plants in *Compositæ*, as *Calliopsis bicolor* *Rehb.* (*Coreopsis tinctoria* *Nut.*); scrophularineous plants, as the pentstemon (see the remarks under *Pentstemon pulchellum*, above); violaceous plants, as the varieties of heartsease; of balsamineous plants, touch-me-not, &c. &c. Some of these, if sown early, will not vegetate for some weeks afterwards; but let not this discourage the hopeful sower: when they vegetate, they will do so more vigorously, by virtue of a certain preparation which they derive from the soil. The nature of this preparation I am not able to describe; but the fact of such a preparation taking place is evinced by the satisfactory health and vigour of plants which have sprung from naturally sown seeds, while not rarely the plants from artificially preserved seeds are less healthy and vigorous, and, consequently, less satisfactory. These remarks, however, scarcely at all apply to the tropical annual plants with branched fibrous roots. In these, the rate of growth is so rapid, that the space of our summers is usually sufficient to enable them to return their seeds commonly with increase; and were the seeds of such plants sown before the soil and climate of Britain are becoming warm, they would not only not be benefited, but even rotted and destroyed. It may not be known to every one, that seeds of the yellow everlasting (*Helichrysum bracteatum*) naturally shed in the autumn, lie unhurt in the soil through the winter, and produce fine plants in the ensuing summer. As this plant is from New Holland, it suggests that most New Holland annuals may endure autumnal sowing with us.

ART. II. *General Notices.*

WITTY'S Improved Furnace.—When we noticed this furnace, in a former Number, we were not aware of the extent of the improvement which it is calculated to effect; the inventor having, in a private letter which accompanied his communication, chiefly insisted on its power of burning waste coal. We have since seen some printed remarks, accompanied by testimonials, which show that the most important advantage of Witty's furnace is the burning of the smoke, by which a saving of from 20 to 30 per cent of fuel is obtained; and the atmosphere in the neighbourhood of the furnace is not polluted with smoke. It also appears that rather less attendance is required than with a common furnace, whether for hot-houses, steam-engines, or dwelling-houses.

The first principle of excellence in the construction of this improved furnace is the way in which it is supplied with fuel. By the common mode, the moment the door of the furnace is opened, a rush of cold air sweeps through the flues, or under the boiler, carrying off much heat. Cold, and perhaps moist, coal is then thrown on the very centre of the fire, which not only reduces the heat, but occasions a quantity of dense smoke to be emitted from the chimney; and this smoke, when once formed, cannot be burned except at a temperature (3000° Fahrenheit) that will melt iron. This temperature would, of course, require an amazing expense of fuel. The mixture of about one twelfth of atmospheric air with carburetted hydrogen, of which smoke of coal is chiefly composed, produces combustion at a high temperature. By throwing on a fire unprepared coal, not only this inflammable gas (carburetted hydrogen) is generated, but also nitrogen, carbonic acid gas, and other non-inflammable gases; and it has been proved, that when smoke contains one sixth part of nitrogen, or one sixth of carbonic acid gas, it will not inflame. Hence the difficulty of consuming smoke. In order to overcome this difficulty, Mr. Witty divides the consumption of coal into two distinct processes: viz. carbonisation, by which the coals are thoroughly dried, and freed from their watery and gaseous matter; and combustion, in which the carbonised coal, or coke, is consumed along with the watery and gaseous matter which is distilled from that portion of coal which is undergoing carbonisation. By these two processes, the maximum of heat is obtained from any given quantity of fuel; and this without one particle of smoke. By Mr. Witty's plan, the atmospheric air is nowhere admitted but through the coke fire, and this inflames all the gaseous matter, as it is evolved from the coal undergoing distillation.

It is important here to observe, that, as a very high temperature is essentially necessary for the consumption of smoke, that object can never be effected under a boiler in which water is not raised much beyond the boiling point. Now, the great superiority of Mr. Witty's plan is, that the smoke is consumed before the flame and the heat come in contact with the boiler. We are the more anxious to direct attention to this, because, in heating by hot water, it will be found necessary to place the boiler not immediately over the fuel, but rather over the commencement of the flue; or, at whatever may be the point where all the gaseous matters are consumed. It will be seen in our advertising sheet that this furnace has been erected in several gardens, and that it has given the highest satisfaction. Mr. Miller of the Bristol Nursery has had two furnaces put up to his steam boilers, which, he says, effectually consume the smoke, and produce a greater quantity of heat with less fuel. Mr. R. Miller, the very intelligent gardener at Alton Towers, who has had the management of several of the hot-houses and conservatories there, strongly recommends it as being preferable to any other furnace that he has seen, producing a great heat generally diffused, with less coal and no smoke.

There is one of Witty's furnaces erected at Lee's Nursery, Hammer-

smith, and another at Henderson's in the Edgware Road, both of which we have examined; and we must say, that we were gratified far beyond expectation at the simplicity of the apparatus, and the complete manner in which it burned the smoke. At Mr. Lee's, the furnace is applied to flues which never before had a good draught, but now draw as well as the best hot-house flues. At Mr. Henderson's, one furnace has supplied the place of three. To convince some gentlemen present that the smoke was effectually burned, Mr. Chanter (the present proprietor of the patent) had two top tiles taken off the flue in Mr. Henderson's pine-stove, when, instead of smoke, nothing but a warm moist vapour was felt, so totally without smell, that it might have been admitted to fill the atmosphere of the house without any injury to the plants.*

These advantages, taken together with a saving of 30 per cent in fuel (clearly proved by other experiments), leave no doubt in our minds that this furnace will soon be substituted for every other in hot-houses, whether these may be heated by hot water, steam, or common flues. The improvement will not serve as a substitute for the mode of heating by hot water; but it will lessen the expense of that mode, by the saving of fuel and of labour in attendance.

We look upon the burning of the smoke as an immense advantage; whether we regard the plants in gardens where there are numerous hot-houses, or the atmosphere of towns, in coal countries, all over the world. M. d'Arcet of the French mint, who lately resided some weeks in London, found by prepared paper tests, which he pinned every morning to his hat before he went out, that the atmosphere of the metropolis contained a considerable proportion of sulphuric acid, undoubtedly diffused in it by the coal smoke. By the use of Witty's furnace, both in public and private establishments, in all cases in which close fires are or can be employed, such as in boiling water, or in heating ovens, stoves, or hot plates for French cooking, &c. &c., a small proportion of this sulphuric acid would be got rid of, and turned to account as fuel. As these furnaces admit of making more coal into coke than it is necessary to use in them, every family that had one for any close fire might, while that fire was at work, coke as much more coal as would serve for burning in all the open fires in the house. It is easy to see that, in this way, coal smoke might be got rid of altogether, both in town and country. Here would be an end at once to climbing boys and smoky chimneys. Wherever a family had occasion to use constantly one of Witty's furnaces, they might easily coke in it as much coal as would supply half a dozen open fires. Every country gentleman that has hot-houses will be henceforth inexcusable, as a man of taste, if a particle of smoke be seen issuing either from his gardens or his house. In Birmingham, Manchester, and Liverpool, there need not, in future, be the slightest difficulty in getting rid of smoke entirely. (See Vol. VII. p. 524.) In short, it only wants time and a little authority from the legislature, to banish coal smoke entirely from every part of the British empire, and to leave the architecture of our towns as pure as that of the towns on the Continent. The great beauty of all this is, that it will be attended by a great saving both to individuals and to the public, besides contributing to health, comfort, and humanity. Were this not the case, we should not for a moment contemplate the idea of legislative interference. — *Cond.*

A great Improvement in the Construction of Boilers of every Description has just been made by Mr. Perkins, the celebrated engineer; and, as it is

* Mr. Tomalin, one of the gentlemen present, whom we know to be a good practical chemist, writes thus: — "On the two tiles being removed, I carefully examined it: not the least odour was at all perceptible, and nothing found but a copious and perfectly sweet vapour or steam, quite free from bitumen or smoke, and of an excessively high temperature."

particularly applicable to the heating of hot-houses by hot water, we shall shortly notice it. Suppose we have a common boiler, such as used in common wash-houses, and which Mr. Kewley uses in the siphon mode of circulating hot water; then place another boiler within it, of such a size as to leave only a few inches between the inner boiler and the outer boiler all round, and support it in this position by stays. (*fig. 1.*) Let this inner boiler have a hole in its bottom, about one third of its diameter, and let its rim be 2 in. below the level of the water to be heated. These arrangements being made, and the heat applied below, a circulation instantly takes place, and continues; the water coming into contact with the heated bottom and sides of the outer boilers, rising rapidly to the surface, and descending through the



inner boiler, which thus necessarily contains the coldest portion of the liquid. One great advantage of this construction is, that the bottom of the outer boiler, having its heat constantly carried off by the liquid, is not liable to burn out. For the siphon and level modes of circulating water in hot-houses, this boiler promises to be a great improvement. It is our intention to try a boiler of this sort over Witty's furnace. — *Cond.*

An improved Boiler for heating by hot Water. — Sir, Heating by hot water is that branch of engineering which I profess more particularly, and in which I have proved most successful; having always acted upon the late Mr. Tredgold's system, which I perhaps understand the better from having been Mr. Tredgold's principal clerk up to the last hour of his life; and I am the person who made out the original drawings (under Mr. Tredgold's directions) for his paper in the *Transactions of the Horticultural Society*, which was copied in your Magazine. (Vol. VII. p. 179.)

Having had every opportunity of proving by the many apparatus which I have had the honour to execute, as far as theory and design extend, that such calculations as respect the surface of pipe are, beyond a doubt, correct, still I think that the calculation for the size of the boiler is not sufficiently clear; for a furnace may be so constructed, that although a given quantity of fuel may be consumed in a given time, yet that a great portion of the heat from that fuel may escape though the flue, without being of service to the boiler.

The plan which I have for some time past adopted is, to vary the length of the boiler with the surface of pipe required; invariably making use of a long rectangular boiler in preference to a square or circular boiler, as it

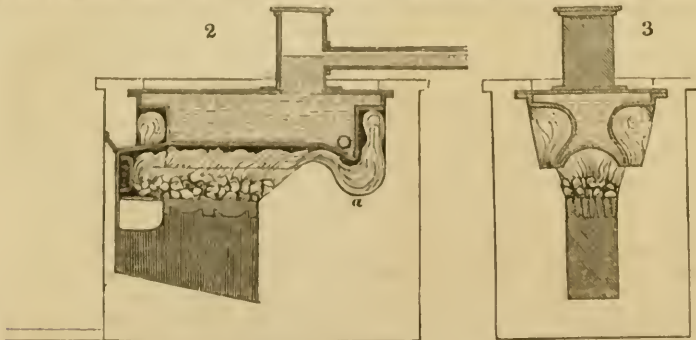

Longitudinal section of boiler and furnace.

Transverse section.

is a well known fact that the bottom surface is far superior to the side of a boiler in absorbing heat; consequently, the longer the heat is retained

on the bottom of the boiler, the more effective it will be. Under such impressions, I have turned my particular attention to that form of boiler which is most likely to answer the required end; and I have lately had them constructed to the patterns shown in *figs. 2, 3, 4, and 5.*

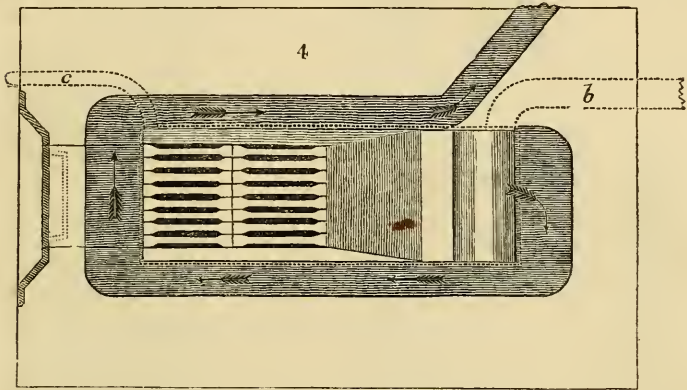

General plan of bars and flue; the dotted line *b* is the supposed position of the lower pipe; the dotted line *c* is a pipe for drawing off the water from the boiler and pipe.

and I have found them to answer beyond my most sanguine expectations. I have found that the required heat for a house has been raised in much less time, and with less fuel, than with the square or circular boiler; for a.though 1·2 lb. of coals will boil a cubic foot of water, in a vessel properly

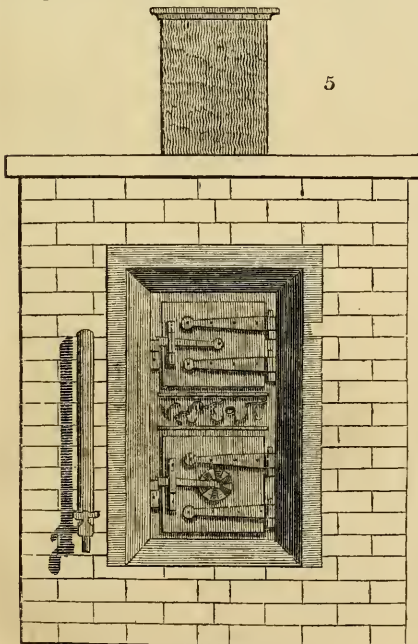

Elevation of furnace.

constructed for that purpose, yet such a nice calculation is not suitable for a hot-water apparatus. For instance, the proprietor would sometimes burn coal, sometimes coke or wood, or perhaps only cinders; therefore, the more economical the furnace is constructed for such purposes, the better. The dip shown at the end of the boiler (*fig. 2. a*) has a tendency to prevent the flame from passing so rapidly over the bottom as it would do on a straight bottom. The upper part of the flue passing round the boiler, is entirely covered by the upper part of the boiler; and I always bear in mind to let the lower pipe enter the boiler where it is least exposed to heat. I am, Sir, &c. — *D. D. Neeve.*
6. Wyndham Street, Bryanstone Square, Sept. 1831.

Steam Carriages, it appears by the report of the select committee of parliament, can be propelled on common roads at an average rate of ten miles per hour; ascending and descending hills of considerable inclination with facility and ease, and a great saving of expense. How great, then, would be the advantages of equalising, or nearly so, the inclination of all slopes! We have shown (*Morning Chronicle*, Dec. 31.) that this equalisation of slope, even with the aid of horses alone, would not only nearly equalise the value of territorial property, and all its various products, but that it might go far to equalise the fertility of soils, by the facilities which it would give to the transport of earths which were superfluous in one district, to others in which they were deficient. The practicability and advantages of using steam carriages on common roads adds greatly to the value of our own suggestion. — *Cont.*

A regulating Thermometer, for effecting the same objects as Mr. Kewley's Automaton Gardener (*Encyclopædia of Gardening*, 2d edit. § 1490.) has lately been invented by Mr. J. Lindley (not the Professor), and exhibited in the library of the London Horticultural Society. From a general view of the exterior of this machine, it does not appear to us any thing like so perfect as that of Mr. Kewley; it will also cost more, and, instead of regulating the temperature to a quarter of a degree, like the automaton gardener, it does not operate till a change has taken place of more than 15°. The invention, however, has merit; and we are exceedingly glad to see it brought forward, because we trust it will stimulate Mr. Kewley to put his simple and most ingenious engine in the course of manufacture for public sale. We believe that, for five guineas, Mr. Kewley can produce an instrument not at all liable to go out of repair, which would open and shut the windows of the largest church, public room, or hot-house, so as to regulate the air within to any required temperature. We have felt confident, since we saw this machine, that the business of forcing and exotic culture in gardens, and of ventilating and regulating the temperature of hospitals, crowded theatres, and other large or now badly ventilated places, might be greatly simplified and economised by Mr. Kewley's invention. When we take in connexion with this the present facilities of heating hot-houses of every kind; and not only of heating them, but of preserving heat in reserve by large cisterns of hot water, we feel convinced that the whole business of forcing, or at all events of keeping hot-house and green-house plants through the winter, might go on for days together with perfect safety, without the attendance of a gardener, or of any person whatever. It is evident that these improvements will also tend to render the use of hot-houses more and more general; so that, if the taxes on glass were taken off, we should not have a farm-house or a tradesman's cottage without its green-house or grapery.

A self-acting Apparatus for regulating Temperature has lately been invented by Dr. Ure, the scientific author of the *Dictionary of Chemistry*. The principle of the instrument is the unequal expansion of different metals by heat. The Doctor proposes its employment to regulate the safety-valves of steam boilers; but there can be no doubt that such machinery might be added to it as would fit it for opening the windows of hot-houses, churches, or dwelling-houses, and opening or shutting the dampers of chimneys, or diminishing or increasing the draught of fireplaces. The details of construction will be found in the *Repertory of Patent Inventions* for December 1831, vol. xii. p. 345. — *Cont.*

An Instrument for laying off or transferring Angles, in laying out Flower-Gardens, or performing other Operations in Landscape-Gardening or in Garden Architecture. — Sir, Herewith you will receive a drawing (fig. 6.) of the different parts of an instrument for laying off or transferring angles, which, perhaps, you will think worth publishing for the benefit of your

practical readers. I invented this instrument (if it may be dignified with the name of an invention) more than two years ago, since which time I

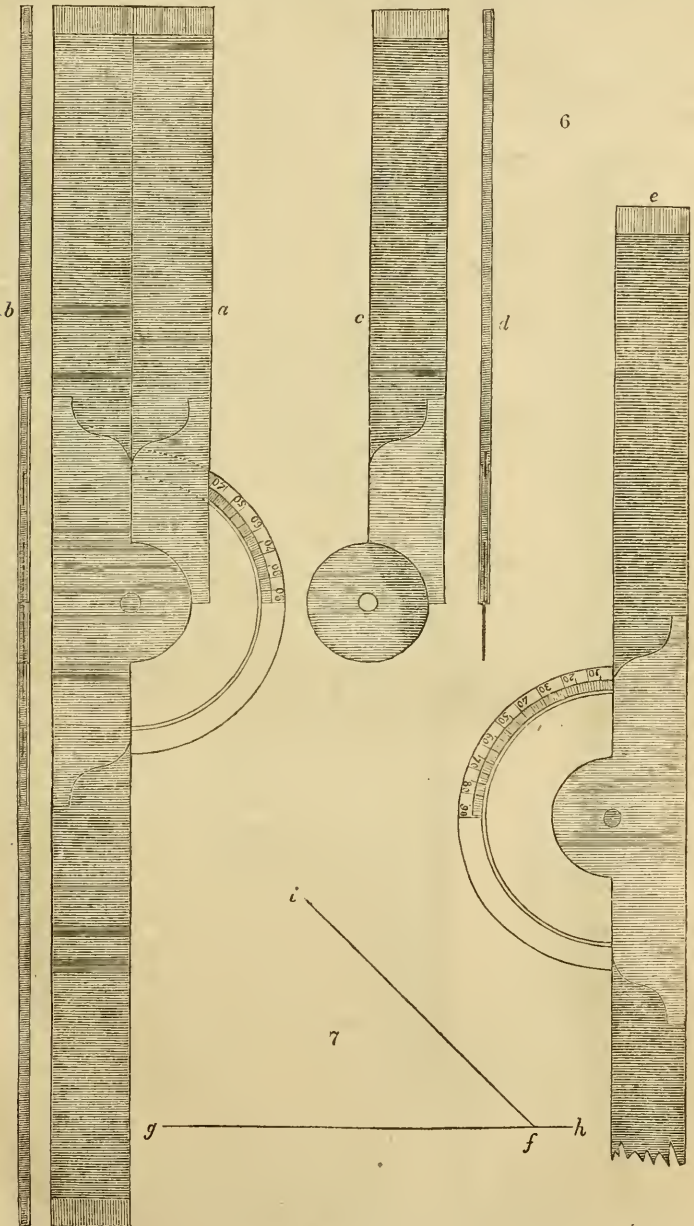

have found it of very great service; being more quickly applied, and, I believe, more correct than the protractor; especially if the person using the latter should be not very particular in setting off the centre line, and the degree of the angle which may be required. My instrument is made very neatly by Mr. Cook of Crown Court, Soho, from a model of my own construction. *Fig. 7. a*, the instrument, the longest side 2 ft. long; *b*, the edge of the instrument; *c*, the short leg, removed from the long leg; *d*, the edge of the short leg; *e*, part of the long leg, showing the quadrant.

8

9

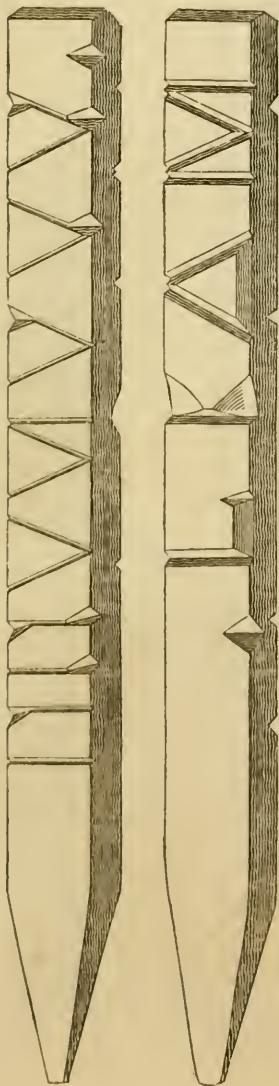

Fig. 7. a diagram showing the mode of using the instrument. Supposing it were required to draw an angle of 45° from the point *f*, on the line *g h*; place the short leg parallel with the line, so that the long leg touches the given point, then draw the line *i f*. If you require a perfect triangle, turn the instrument over, and draw a line along its side, and the triangle will be completed; each side of the instrument being alike in length, and perfectly flat. — *D. D. Neeve. 6. Wyndham Street, Bryanstone Square, Aug. 14. 1831.*

An improved Numbering-Stick on the Notch Principle. — Sir, If you think, with me, that my notch numbering-stick is superior to any thing of the kind now in general use, you will not hesitate to make it, through the medium of your Magazine, more generally useful. It is equally as simple and comprehensive as Seton's, and the signs used are not so apt to be confounded with each other. I have adopted three new signs, the 2, 3, and 4; from which, with the 1 and 5 in common use, I make all the others thus (*fig. 8.*): —

A notch added to 1, on the left side, at the top, makes 2; at the bottom, on the right side, 3; and at top and bottom, 4. The 1 added to 5, and connected at the top, makes 6; and in like manner, as the notch is added to 1 to make 2, 3, and 4, so is it added to the 5 to make 7, 8, and 9. — *C. L. B. Sept. 3. 1831.*

The above is certainly a great improvement on Seton's mode, because there is less new to learn in it, and consequently it will be more easily remembered. The great objections to all partially known signs are, their liability to be forgotten by those who use them, when they have been a very short time out of practice, and the difficulty of setting a stranger to work in a garden where such numbers are used. A nurseryman who would use Seton's mode of numbering for his fruit trees, must either attend to every thing connected with those numbers himself, or be dependent on one or more incli-

viduals, who might suddenly leave him, or fall into ill health. For this reason we have often thought that the best notch mode for general use would be one in which the Roman numerals are employed, using the common notch for 10, as now generally done; imitating the letter L for 50, C for 100, D (or delta) for 500, and M for 1000. (*fig. 9.*)

It is true, a good deal more cutting is required by this mode, than by either Seton's or the improved mode of C. L. D.; but the simplicity and universality of this old or Roman mode, as it may be called, will in our opinion more than compensate for that disadvantage. — *Cond.*

Brick Tallies. — We, in a former Number (Vol. VI. p. 310.), expressed our intention of having some brick tallies made by Mr. Peake of Tunstall, and Mr. Allardyce of Clay Hills, near Aberdeen; and both these gentlemen have accordingly sent us specimens. Those of Mr. Peake, from our sketches (*fig. 10.*), are of terro-metallic earth, as hard

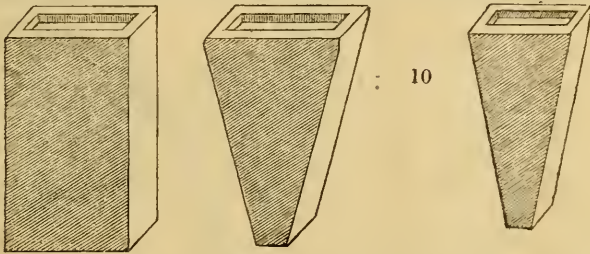

almost as cast-iron; and they must be more durable than any other description of earthen manufacture, since they are to a great extent vitrified, and yet not only hard but tough. Our error in making the sketches for these tallies consisted in not giving them a beveled end; but this could be remedied in future. Mr. Allardyce has sent us a brick earth tally of his own invention (*fig. 11.*), which, having a beveled face, appears to us to

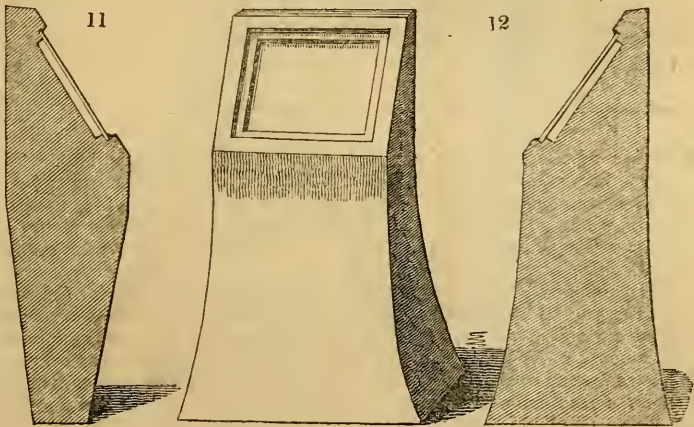

be a near approach to perfection in that particular; but we think it ought to be longer, perhaps 12 or 13 in. long, to keep the glass which covers the name from being dirtied by the splashing up of the earth during heavy rains. This tally, though not made of so durable a material as that of Mr. Peake, is yet far harder than the hardest clinker bricks, and, not

being brittle, must last a very great length of time. Were it not for the greater quantity of clay required, we should prefer the tallies broader at bottom than at top; because they would then be more certain of standing upright, and would sink more slowly into the earth. It was thought that a deviation from the shape of the common brick would procure an exemption from the excise duty; but Mr. Allardyce found this not to be the case. A tally a foot high, formed in the upper part like that of Mr. Allardyce, with nearly straight sides, but spreading out a little at the base, made of Mr. Peake's ferro-metallic earth (*fig. 12.*), would, we think, approach very near perfection; and would be particularly useful in an arboretum, where, as at Syon, for example, the trees were allowed to attain their full age and growth. — *Contd.*

Budding's Machine for cropping or shearing the vegetable Surface of Lawns, Grass-plots, &c. — A technical description of this machine is given in the *Repertory of Patent Inventions*, vol. x. p. 327., accompanied by an

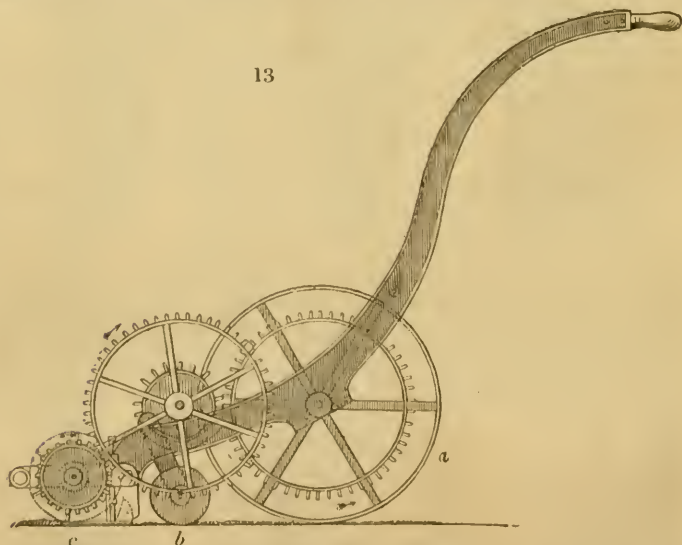

elevation of the left side (*fig. 13.*), and a ground-plan (*fig. 14.*). The machine being pushed forward, the hollow cylinder or cast-iron roller (*a*) is put in motion, and also the smaller cylinder or gage-roller (*b*), the purpose of which is, to regulate the height of the rectangular steel plate (*c*). The operation of shearing is performed by from four to eight spiral cutters (*d*), which revolve on a horizontal axis.

In the operation of pushing forward the machine, the cylinder (*a*) rolls upon the ground like the wheel of a wheelbarrow; and, by the wheels and pinions connected with it, causes the revolving cutters (*d*) to act rapidly, by their smooth outer edges, against the edge of the fixed rectangular steel plate (*c*), so as to crop or shear the grass or vegetable surface. The smaller cylinder (*b*) serves effectually to regulate the height, and to insure the steadiness of the rectangular fixed cutter (*c*), against which the revolving cutters act. To keep the smaller roller (*b*) sufficiently free from any adhering substances, there is a horizontal box (*e*), which serves as an axis for a thin iron scraper, which is curved so as to form a portion of a cylinder, having its lower edge bearing on the surface of the roller.

The speed with which the machine is pushed forward when at work is

not material, because the number of cuts will always be in the same ratio with the space rolled over by the roller or larger cylinder (*a*). The revolving parts are here driven by wheels and pinions, but endless lines or bands may be employed instead of teeth. "It is advisable," the patentee ob-

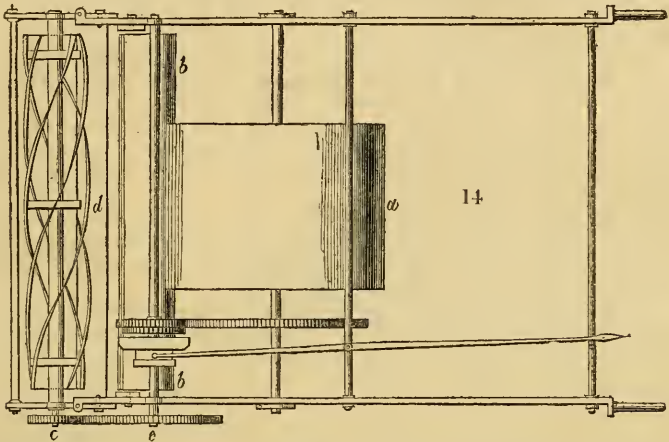

serves, "to employ the machine when the grass or vegetable surface is dry; and when high grass is to be cut, it is best to shear it twice over;" for which purpose, there is a simple contrivance for raising, or lowering, and adjusting the cutting parts of the machine. "Grass growing in the shade, and too weak to stand against a scythe to be cut, may be cut by this ma-



chine as closely as required; and the eye will never be offended by those circular scars, inequalities, and bare places so commonly made by the best mowers with the scythe, and which continue visible for several days." "Country gentlemen," he adds, "may find, in using my machine themselves, an amusing, useful, and healthy exercise."

In the specification of the patent, it was unnecessary to notice that all the grass cut off may be collected in a box (*fig. 15.*); but this we consider a valuable addition, as saving sweeping, and as completing the oper-

ation of mowing as it proceeds; so that the operator may leave off at any moment, and at the same time leave what he has done perfectly neat and finished. The machine is easily rolled from one part to another without cutting, by merely lowering the handles, so as to lift the gage-roller from the ground; the machine may be then pushed forward or drawn backward, the operator stooping a little, without any other effect being produced than that of a common roller.

Manner of keeping the Machine in order. Occasionally apply sweet oil to the pivots or ends of the axes, and along the straight edge of the rectangular blade. When the revolving cutters require sharpening, oil the edges, and shake a little flour of emery on them; then screw the iron handle into the rim of the toothed wheel which is outside of the frame, and turn it backwards for some time. Lastly, wipe the blades quite clean from the emery, and set the adjusting screws.

Should any part of the machine be broken by accident, a new part may be had from the manufacturer, J. Ferrabee, Phœnix Foundry, near Stroud (see advertising sheet), to fit into its place exactly, thus enabling almost any person to repair the machine.

We have before (Vol. VII. p. 611.) expressed, and now repeat, our satisfaction at the circumstance of this machine being calculated to improve the grass lawns of warm countries, from its "cutting grass or other herbage too weak to stand against a scythe." This will insure the machine a good reception on the Continent and in America; and it will probably enable the more wealthy cultivators of the latter country, and of Australia, soon to indulge in a garden luxury; which, if they had it to procure by manual labour, would probably long remain beyond their reach. We have elsewhere (Vol. VII. p. 692.) mentioned that we have seen it at work in the Zoological Gardens, Regent's Park. Mr. Merrick of Cirencester writes:—"I have had one of Budding's machines in use, when the grass required it, all this year, and am highly pleased with it. The narrow machine is best for a gentleman who wishes to use it himself, and also for grass borders; but the wide ones are preferable for workmen who have much to cut."—*A. Merrick. Cirencester, Sept. 17. 1831.*

French Mole Trap.—Moles are, perhaps, most troublesome from Michaelmas to Lady-day. The common wooden trap operating by a spring-

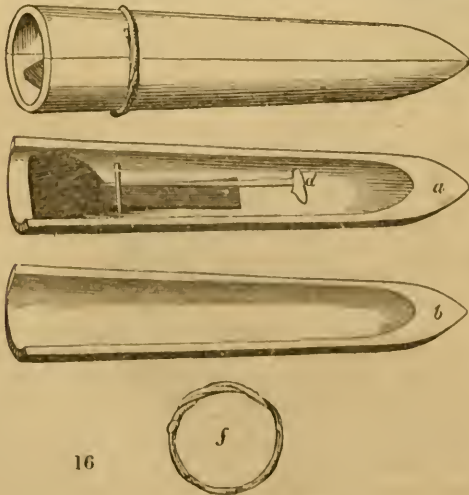

bow which is disengaged by the mole's burrowing, and then catches and kills the mole by constriction, is a very good one; but the cast-iron trap, on the principle of a forceps, closed by a spring, as soon as the mole displaces the bridge by which the trap's jaws are distended, is, perhaps, better. We have, however, to submit another to consideration (*fig. 16.*), which we brought from France in 1829, and which consists of two sec-

tions of a hollow cone (*a b*), with a spring within (*c*); which being set free by the mole's entering and pushing forward the plate (*d*), the spring *c* raises the valvular stopper (*e*), which prevents the retreat of the mole. The ring of withy (*f*), which might be of iron, is for keeping the sections of the cone united when the trap is set; and, of course, it is slipped off every time a mole is taken out.

Mr. Murray, of the botanic garden Glasgow, has rightly suggested that it would be an improvement to have traps of this kind made in pairs, one at each end of the same piece of wood, but still to keep them distinct in the middle; so that, let the mole encounter either end, it may have an opportunity of entering. — *Cond.*

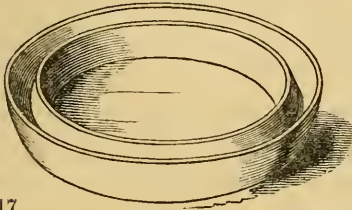

17



Gauntlets for Lady Gardeners. — Sir, The extensive range taken by the varied contents of your Magazine, and, above all, the kindly interest felt by yourself in every thing conducive in the smallest degree to the comfort of others, induces me, without apology, to trouble you with the following communication, trifling though, I fear, it may appear to many of your readers. Perhaps it may seem ridiculous to those whom cuffs of broad-cloth render invincible by such evils, to say, that, having for some years (even from the time that I could first wield a knife for that purpose) been

18

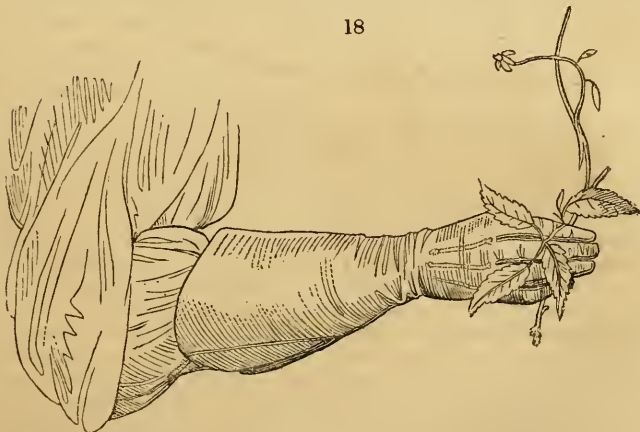

in the habit of keeping pruned the rose-bushes of a small garden, I have always experienced much inconvenience from their prickles, which, to say

nothing of the detriment done to the sleeves of the dress, will frequently insert themselves between the gloves and those sleeves, scratching the wrists, and causing no slight degree of uncomfortableness, and, I may say, of present and after pain. To obviate this long experienced difficulty, it at length entered, I cannot exactly say my own imagination, to conceive, that gloves made after the fashion of gauntlets would at once protect both wrists and sleeves from injury; and in this idea some members of my family gave a glove-maker instructions in making a pair of stout leather, which appear as if they would well answer the purpose, preventing the intrusion even of the strongest prickles. Believing that many lady gardeners may have felt the same inconvenienc, without, perhaps, having thought of a remedy, I am induced to send you the accompanying little sketch of one (*fig. 18.*) of the gardener's gauntlets, and the information that they were made by Mr. T. Joy, No. 12. Mount Street, Lambeth, who will undertake to make them to order of any size and description. Yours, &c. — C. P. Surrey, November 22. 1831.

Howden's Gate-shutter Hinge. (*fig. 19.*) — Few things are more vexatious about a gentleman's premises, or even on a common farm, than to have gates left open by careless people. The following hinge, or contrivance for fixing on the lower end of the hanging style of the gate, serves as

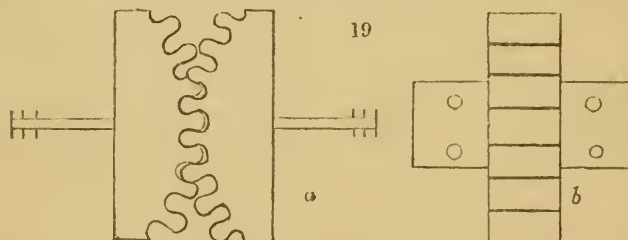

an effectual gate-shutter. Being made of cast-iron, it is both cheap and durable. "You see it looks like two semicircles, working into each other in the way of tooth and pinion: but they are not semicircles, they are not segments of circles, they are not even the two halves of an ellipsis; as I tried all these before I got it perfect. I made the model of a beech board, $1\frac{1}{2}$ in. thick; I formed an ellipsis $7\frac{1}{2}$ by 6 in.: this I sawed in two, on the line of the longest diameter; the segments I cut into regular teeth, or cogs, seven in the one, and eight in the other, so as to work freely into each other; these I tried and altered, till I got the gate to play to the greatest nicety, and then had sets of castings (*fig. 19. a*) for iron gates, and (*fig. 19. b*) for wooden gates. The chief alteration from a semi-ellipsis is flattening the centres, so as to give the gate a home or resting-place. A gate thus hung cannot possibly be left open (unless fastened open), any more than the pendulum of a clock can remain stationary any where but perpendicular to the centre of gravity. The best gates in your *Encyclopaedius*, I see, play upon two centres, which is certainly a great improvement on the old hook and thimble; but then, they are very hard to open at first, and though the fall gradually diminishes up to the square or point where the gate, when open, makes a right angle with the line of the gate when shut, yet, if opened any wider, the fall is reversed, and back it goes with a bang, straining itself all to pieces: whereas my gate, playing upon something like two quadrants, is most easily opened at first, the pressure gradually increasing, not only up to the square, or right angle, but 20° beyond it, both ways. — John Howden. April 30. 1830.

On the Advantages of Mr Phail's Pits for growing early Cucumbers. — Sir, The season having approached when those who desire early cucumbers are

preparing for them, perhaps you will allow me to say a few words by way of recommending M'Phail's pits. I have often heard gardeners of considerable experience say they preferred dung beds, and have, in consequence, been undetermined which plan to adopt. I am, however, fully satisfied that cucumbers may be grown in perfection in pits, and with much greater safety than in beds, in early forcing. Having had an opportunity last year of seeing some pits at work, in one of which the seeds were sown in the beginning of October; and having seen them several times since that period, and found them fully answer the purpose, by producing plenty of good fruit from the seeds then sown up to the present time, without a single failure, during the past winter, when so many gardeners lost their plants from severity of weather; I have no doubt that an account of their management will be acceptable to some of your readers; if, like many with whom I have conversed on the subject, they have hitherto found it difficult to obtain good cucumbers from pits. In the first place, I beg to notice that the size of the pits is not of any consequence; so that those who have frames which have been used for beds may have their pits made to suit them, and they may be made for one, two, or three lights. Having fixed on the place on which to build, mark it out 4 ft. wider than the frames, to allow 2 ft. on each side for the linings; dig it out about 18 in. below the surface of the ground, so that half the brickwork (which will be 3 ft. high) may be under ground; by which means the linings will be better protected from the wind, and it will be much more convenient to get at the inside of the frames. If it is intended to build more than one pit, let them stand 4 ft. apart, that there may be sufficient room to lay dung between them, and allow 2 ft. at the ends of the pit for linings, as at the back and front. The space being dug out, let a brick drain be made the full length, of about 4 in. square, keeping the covering brick a little below the ground, so as to allow all water to drain away from the dung, as well as to receive the water given in the frames. The pits being built, having a flue round and one between each light, let them be filled half way up with brickbats, thrown in loosely. Then put on the frames, and when the work is dry, throw in as much well-wrought dung as will reach about 6 in. higher than the top of the flues, but not to cover the flues, on which dung the hills are to be formed in the usual way. By this means the plants will be raised very near the glass during the winter months, and, by the time the hot weather comes, the dung will have sunk sufficiently low to prevent the sun injuring the plants; the dung also producing a moist heat, the want of which has been so much complained of in brick pits. All other treatment the same as for beds, except that at all times while the weather requires the flues to be heated, plenty of water should be given on the flues once a day at least, which water moistening their sides, and the dung lying against them, causes a steam in the frames equal to a dung bed, which adds greatly to the health of the plants. Another circumstance I wish to notice is, that the plants are often lost by the steam blowing in at the back of lights when left up at night to admit air. This may be remedied by having a row of narrow panes of glass at the upper end of the lights; which may be taken out, and the place covered, as occasion may require, with something else. It has frequently been found difficult to preserve cucumbers in pits from being destroyed by what gardeners commonly call sow bugs (*Oniscus Asellus*). These are encouraged by the frames being kept too dry; but may, however, be easily caught in small narrow boxes without a lid, filled with dry loose hay, put in only tight enough to keep it from falling out when the boxes are placed with the open part downwards; or, if boxes are not easily obtained, common flower-pots will do, placed in the same manner about the frames, into which, after the flues are watered in the morning, the insects will soon collect, and may be taken out and destroyed. I should think that where new lights are made, instead of the bars going from

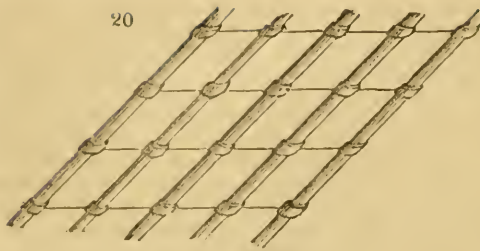

the bottom rail to the top, they might fasten in another rail within 2 in. of the top, leaving a space of that width along the top of the lights to be covered with a lid of tin or copper, hung on hinges, to be raised as occasion required for the pur-

pose of giving air at night (*fig. 20.*)

I am doubtful whether you will be able to understand my meaning; but I am sure if you should, you will easily make others understand it when you have given them a sketch of it, or perhaps will suggest something better. I am, Sir, yours, &c. — *A Lover of Horticulture. Hammersmith, Sept. 28. 1830.*

The Mildew. — Most of the peach and nectarine trees, in a very extensive garden, were long since badly infected with the mildew; and, for the last four or five years, were invariably getting worse, although I was constantly trying almost every experiment I had seen recommended, as well as others, on my own judgment. The result was no improvement, and the trees became so bad that Lord Doneraile advised me to throw them out altogether, and replace them with young ones. Being aware that there was nothing amiss with the roots, and that all the evil was above the surface, I suggested trying them another year, to which His Lordship assented. In January last I had all the nails carefully drawn, and the trees detached from the wall: the nails and shreds being removed, I then cut back every young shoot I conceived likely to break, to an eye or two. My next object was to get the trees most carefully washed with the composition given below; making use of a sponge where it could be used with effect, and in all the crevices and joints using a painter's small soft sash-brush. This being performed, I got all the old nail holes stopped, and the walls perfectly cleaned. I then nailed the trees to the wall again, and I have now the satisfaction to find that I have not the slightest appearance of mildew or blight of any kind. The wood is perfectly healthy and well furnished. The trees are from 10 to 12 ft. in height, and equally spread out on every side. They have been planted about fourteen years, and from their present appearance I can have little doubt of a plentiful crop next season. In fact, those who saw them last January can scarcely be persuaded that they are the same trees.

The following is the composition used: — To four gallons of rain or river water add two pounds soft soap, one pound flowers of sulphur, one pound roll tobacco, one quart fresh slaked lime, and one pint of spirits of turpentine. Mix the whole well together, and boil the mixture slowly for half an hour. I am, Sir, yours, &c. — *John Haycroft. Doneraile, Nov. 1831.*

Cleaning Wall Nails which have been used, preparatory to their being again used. — My gardener used to spend days, and I may say weeks, in winter, in cleaning up his wall nails; to save which time, I take any quantity, as accumulated by collecting from time to time, from the shreds, and boil them in a small copper with $1\frac{1}{2}$ lb. of American potashes to every pailful of water. Two pailfuls will be sufficient to preserve the copper from being burnt. The nails are kept boiling for about two hours, and well stirred up with a stick, and scrubbed with a birchen broom. I clean 40 lbs. at a time, and the same water will serve for many lots; so that I can clean near 1 cwt. in a few hours, and for less than 2s. — *E. S. Sittingbourn, Feb. 3. 1831.*

Destruction of Insects by Ammoniacal Gas.— Sir, Among the various plans hitherto proposed for the destruction of insects injurious to vegetation, particularly under glass, there is scarcely one, if any, that is not liable to some great objection: one of the best, tobacco smoke, leaves a disagreeable smell, very difficult to be got rid of, and is chiefly useful against the aphides. Sulphur, if exposed to a temperature very little above that required for slow evaporation, forms sulphuric acid gas, which is highly destructive to vegetation. Lime renders the plants unsightly, and lime-water is liable to the same objection; while soap is difficult to apply, and more difficult still to wash off, if allowed to dry on. It was with some pleasure, therefore, I saw that Mr. Major, in his work on insects, proposes for the destruction of the red spider a trial of ammoniacal gas, it having been found by Sir H. Davy to be instantly fatal to insect life. In order to ascertain how far this might be applied to plants with safety, in October last I submitted a plant of slender fuchsia (*Fúchsia grácilis*) infested with the red spider, another of common myrtle (*Mýrtus commúnis*) affected with the turtle, or scaly insect (*Cóccus hespéridum*), and a third of nutmeg-scented storksbill (*Pelargonium frágrans*), covered with the common green aphid, to the action of this gas, decomposing the muriate (sal ammoniac) by quicklime in a saucer, and placing the whole under a large hand-light. The result was, that the *Fúchsia* lost, with the insects, all its leaves; the other plants did not seem injured, the turtle insect appeared destroyed, but the aphides seemed to have sustained little or no injury. I believed at the time I had used too great an excess of lime, which, from the heat evolved, I then thought had destroyed the leaves of the fuchsia. I next procured some leaves with cocci (turtle insects) upon them, and others with aphides, and placed them in solutions of ammoniacal gas in water (diluted hartshorn) of various degrees of strength, but found it had little effect upon the latter insects, unless placed in hartshorn of the medium strength; but the turtle insects were soon destroyed, even in the weaker solutions.

It then occurred to me that it would be very easy to saturate an atmosphere of a given extent with the gas itself; but as it is very fugitive, though at the same time rapidly absorbable by water, I thought the best way would be first to saturate the air with moisture, by throwing water upon the heated flues, and, as soon as the plants contained in the house were sufficiently damp, to liberate the ammonia. In a green-house 16 ft. by 8 ft., and about 10 ft. deep, I placed four saucers containing sufficient quicklime to decompose 2 oz. of sal ammoniac dissolved in water, the vapour of which seemed to have had no effect upon either insects or plants the next morning. Considering the vapour not strong enough, I next placed 3 oz. of the salt, and decomposed it in the same way; and by the next day the turtle insect appeared destroyed; but the aphides, though weakened, were left in sufficient numbers to replenish the house, although the gas had been so powerful as to change the more delicate blue and red flowers to green, and, as I in a day or two found, to destroy the leaves of many of the plants, and a few of the plants altogether. The succulent plants suffered most, with a few exceptions: the *Senécio élegans*, *Lobélia cærúlea*, *Leucodéndron argénteum*, *Indigófera filifólia*, and *Hyoscýamus aúreus*, were entirely killed; the cinerarias, fuchsias, lobelias, *Lachenàlia trícólor*, *Heliotrópium peruvíanum*, *Maurándya Barclayána* or *antirrhiniflóra*, *Phœnix dactylífera*, *Prímula prænitens* (or *sinénsis*), *Strelítzia reginæ*, *Boccònia serrulàta*, *Cállá* (now *Richárdia*) *æthiópica*, *Cobæ'a scándens*, *Bulbine aloòides*, cassias, and some of the mesembryantheums, were much injured; while the hoyas, oleanders, citrons, acacias, camellias, aloes, crassulas, most of the mesembryantheums, and heaths, escaped altogether, though all were equally exposed to the vapour. Its effect upon the red spider I could not ascertain, as none were at the time in active existence.

As it is still probable this gas may be serviceable in the destruction of

some kinds of insects, I have been led to send you the foregoing account, hoping, at least, it may save some trouble and disappointment to others, if no better use can be made of it. — *Sigma. Saffron Walden, March 3. 1831.*

This article should be read in connection with that subsequently written by Mr. Robert Mallet, and published in our Vol. VII. p. 557. — *Cond.*

The Culture and Curing of Tobacco by every Gardener, in order to employ it in destroying the Insects which infest his Plants. — There is nothing more common, when walking through houses of different descriptions, than to see many of their inmates covered with insects, which might be easily destroyed by fumigation; and should you make an observation on this, you will frequently be told that the owner grudges the expense of a few pounds of tobacco in a year for their destruction. I have myself been placed in such circumstances, and been driven to many shifts to get rid of insects, rather than apply for the proper remedy. These shifts have for some years past induced me to grow my own tobacco: and, although I do not manufacture it pleasant enough for the mouth, I do it well enough to destroy any insect for which tobacco is used. As I have in general plenty of it, I have no occasion (except for a single plant) to use either bellows or patent syringe: for I make a few small heaps about the house upon a lighted coal, and it requires no other attention till burnt out, when the insects will have dropped; as, not having to be in the smoke, I can give them a little more than I should perhaps like myself. Should this appear in your Magazine at an early period, perhaps some of your correspondents will give further information on the subject before the spring, that I and others may receive the benefit of it. I have tried many ways to obtain the best crops of tobacco: such as sowing in frames very early, pricking out and potting in small pots, then finally planting out, &c.; but the best method I am acquainted with is the following:— About the middle of March make up a dung bed, according to the quantity required to be transplanted; say 2 yards wide and 3 long, and 2 ft. high; put on about 3 in. of mould, not too light, as a loamy soil hangs better to the roots when wet, and thereby assists the plants when removed. I usually cover part of the bed with hand-glasses, and leave part without protection. By this means, that which comes up first is, of course, soonest fit to plant out, and the other does to make good any that may have failed at the first time of planting; as there will always some fail. Plant out as soon as large enough, either in single rows in different places, or in rows 5 ft. apart and about 18 in. from plant to plant in the row. No other attention is necessary, but to pick off the flowers as they appear, and gather the leaves when full grown, and, if it can be done, dry them in the shade. When dried, so as not to be in danger of the leaves rotting, put them in a heap to heat, or, if the quantity is not sufficient to heat, press it well into a sack, and lay it either in a sufficient quantity of moist litter or on a flue with a gentle fire; in a short time it will acquire the smell of tobacco, and may be laid by in boxes, and used as required. I have sown the seed in the autumn in a viney, not forced, and planted out the plants in the spring, which is a good way to have it forward; but, for general practice, the first method is recommended by yours, &c. — *E. S.*

To detect stolen Posts or Pales.—Bore holes in them, and fill them with gunpowder, or crackers; when the thief puts them in the fire they will tell tales. (*Newsp.*)

Blue Colour from Buck Wheat. [Qy. from all the Polygonums?] — The following is given as a method of extracting a blue colour from the straw of buck wheat: — The straw should be gathered before the grain is quite dry, and placed upon the ground in the sun, until it becomes sufficiently dry to be taken from the husks with facility. The wheat having been removed, the straw is to be piled up, moistened, and left to ferment till it is in a state of decomposition, when it will become of a blue colour: this indicates

the period when it should be gathered, and formed into cakes, which are to be dried in the sun, or in a stove. On these cakes being boiled in water, the water assumes a strong blue colour, which will not change either in vinegar or sulphuric acid. It may, however, be turned into red with alkali, into a light black with bruised gall nuts, and into a beautiful green by evaporation. Stuffs dyed blue with this solution, which is to be used in the same way as vegetable matters of a similar species employed in dyeing, become of a beautiful and durable colour. (*Lit. Gaz.*, Oct. 9. 1830.)

Temperance Societies are doing incalculable good here, as I can testify from personal observation. In the Edinburgh Society we have already above 2500 people; some of whom told me, that even one glass of whisky per day cost them 2*l.* 10*s.* a year, confessing at the same time that they knew it did them no good, but perhaps harm. The Society says nothing against the proper use of malt liquor or pure wines. There is so much of a free-masonry sort of feeling among gardeners, that I should think a Scottish Gardeners' Temperance Society would produce a grand public and private effect in England. — *R. Edinburgh*, Nov. 17. 1831.

We insert the above because it is sent us by a much valued correspondent; but we have higher hopes of gardeners than to suppose that if any of them were addicted to more drinking than they could afford, or than was good for their health, they would find it necessary to get rid of the practice by binding themselves by the rules of a Temperance Society. Perhaps there may be some persons who require such a species of coercion, and Temperance Societies may therefore act as a palliative of the disease in this case; but we have little confidence in them even for this purpose, and we look upon them as not at all calculated for removing the cause of the evil. The majority of persons who drink to excess, do so, we apprehend, as a source of enjoyment, for want of something better. Open up various resources to them, and you will at least divide their enjoyments. This is gaining something. Misery of various kinds induces many to resort to the momentary oblivion produced by alcohol; incessant toil requires occasional indulgence; and the practice of drinking, once commenced, soon becomes a habit, and doubtless increases the misery it was intended to relieve. If the object of Temperance Societies were to enquire into the causes of this misery and its remedies, we should strongly recommend them to gardeners. In some able articles on this subject in the *Mechanic's Magazine*, the uselessness of the Temperance Societies, as at present constituted, is forcibly pointed out, and the causes of drinking traced to the bad laws and bad usages which have entirely cut off the bulk of the people from a great many sources of innocent and healthful pleasure, while they have restrained them in the enjoyment of others. Every thing which could diminish the workman's hours of hard labour has been carefully guarded against; while nothing has been adopted to increase, to purify, or to heighten his pleasures. Render men comfortable and happy and there will be no occasion for Temperance Societies; but it would lead us too far to point out the evils which require to be remedied. We refer to the various articles on the subject in the sixteenth volume of the *Mechanic's Magazine*, and more especially to the articles in p. 109. and 202.

In the mean time, if any gardener is in the habit of taking a dram of whisky every morning, and wishes to leave it off, let him begin with a large bottle of the spirit, and every time he takes out a glass of whisky, let him put in a glass of water. This is the way in which people cure themselves of taking laudanum, to which, by the by, we understand the Temperance Societies about Glasgow and Paisley have driven some of their members. — *Cond.*

FLORICULTURE.

A Plan for removing choice Florists' Flowers from one Pot to another without Injury. — Sir, I herewith send you a plan of mine, for removing the more

choice prize flowers from one pot to another, without injury to their vegetation. Another advantage of my plan is, that the plant may be raised so that

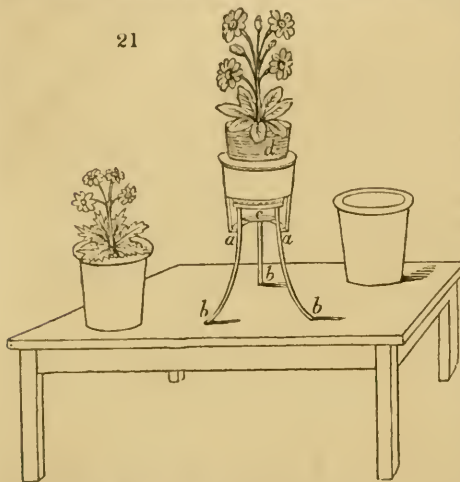

the lower part may be examined, and any slug or insect, found among the roots, destroyed. *Fig. 21.* represents a table with three pots. I have taken away the lower part of the centre pot, to show the inside of its bottom, as my plan is to have pots with loose bottoms. A small projection (*a*) round the inside of the sides of the pot is made for the movable bottom to rest upon. When I want to remove a plant, I have a light rim, the size of the opening of the pot, with three upright spring legs (*bbb*). These are riveted to the rim *c*, and are calculated to bear the weight of the plant and earth; and, by pressing on the ledge of the pot, the plant may be raised to any height (*d*), or turned out of the pot. By having pots made of certain sizes, the bottoms may be removed along with the plant. I am, Sir, yours, &c.—*M. Saul. Sulyard Street, Lancaster, Oct. 3. 1829.*

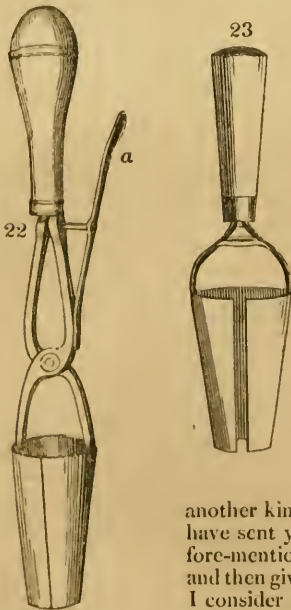

A new Tulip Transplanter. (fig. 22.)—Sir, I am inclined to think you will consider my invention of a tulip planter not unworthy of a place in your Magazine, in order that your readers may judge of it for themselves. A few weeks ago a tin tulip planter (*fig. 23.*) was brought to me as an excellent thing for planting tulips with. It did not appear as such to me; but I requested the person to let us go to the nearest garden, to try it, in order that I might point out its defects. In the first place, I pressed it into the tulip bed, and then I was able to prove that it would not bring up the earth perfectly. I afterwards pointed out another defect in discharging the earth; and the answer was, how could I remedy it? I requested to have a few days for that purpose: I consequently gave orders to have another kind of tulip transplanter made, which I have sent you (*fig. 22.*), together with the one before-mentioned; so that you may try both plans, and then give your judgment as to which is the best. I consider there is a great advantage in having the apparatus to open, with a spring (*a*) to close it again.

When the tulip-bed is prepared, this apparatus is used to take out the earth, after which the bulb is placed in the hole; and then, by pressing the spring, the earth is discharged on the bulb from the machine with the greatest ease. This apparatus is so simple, and so easily worked, that I think it might answer for a variety of horticultural purposes, by having it of different sizes, for the transplanting of different things. I remain, Sir, yours, &c.—*M. Saul. Sulyard Street, Lancaster, October 7. 1831.*

We have not had an opportunity of trying this instrument, but it promises to be an excellent one for the purpose proposed, and it certainly merits the attention of those who study the exquisite, or what the Germans call the *aesthetik*, in floriculture. The French have a transplanter, calculated to effect the same object; but not with such nicety, because it wants the spring. Our readers will find the French transplanter figured Vol. I. p. 268. — *Cond.*

A cheap Awning for Beds of Tulips, Ranunculuses, &c. — Sir, The kind of awning of which I now send you a sketch (fig. 24.) and description is

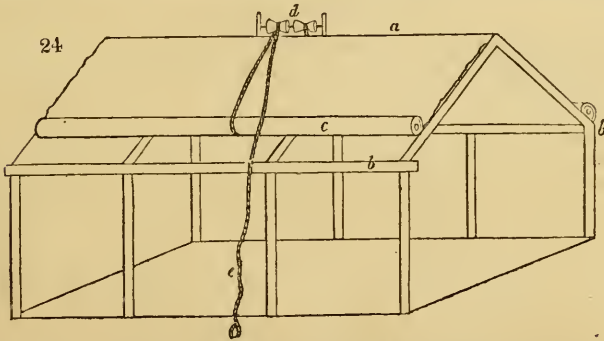

quite a cheap one, and is much used by the Lancashire tulip-growers. It consists of a few uprights and rafters, and a piece of canvass which is fixed at *a*, and extends to *b b*. A strong roller (*c*) is fixed to the edge of the canvass; a cord is fixed to the roof, under the canvass, and brought round the roller *c*, and over the canvass to a pulley at *d*, so that by drawing the cord *e*, the canvass is rolled up by the roller *c*. By the use of a similar cord on the other side, running in a distinct pulley at *d*, either side of the awning may be pulled partly or wholly up, as circumstances may dictate. I am, Sir, yours, &c. — *M. Saul. Lancaster, Sulyard Street, Oct. 16. 1830.*

Accommodating half-hardy Exotics to our Seasons. — Sir, From the observations I have made on early-flowering plants placed against south walls, I am decidedly of opinion (where fruit is not the object) that we are in error; and that, instead of their being planted against a south wall, with the idea of their receiving the sun in the winter and spring months, thereby forwarding them unduly, all early-flowering plants should be placed against north walls; as it must be quite clear to persons acquainted with such plants, that the grand object is to retard their blooming as much as possible until the season is sufficiently advanced for them to expand without the liability of being destroyed by frost. As a proof of the correctness of what I state, had that fine plant of *Wistaria Consequana* in the garden of the Horticultural Society been on a north wall instead of a south, the bloom would not have been destroyed by frost, as was the case last year. Camellias also ought to be retarded as much as possible, as it is well known that the first sharp wind or frost will spoil the beauty of the blossom. I have had a fine plant of the striped camellia bloom beautifully the last

two seasons against a south wall ; but, what with the cold at night and the sun in the day, the flowers were not in perfection above twenty-four hours. So much for the extremes of heat and cold. South walls should only be covered with late-flowering plants, as those are the plants which require to be brought forward. I am, Sir, yours, &c..—*II. Groot. Walworth, April 12. 1831.*

Method of prolonging the Flowering Season of Border Flowers.—*Lupines*, yellow, large blue, small blue, white, and straw-coloured. For all these the same mode of culture will suffice. The seed should be sown between the 20th and 30th of March, in pots, size 32, or larger, and not too thickly. When the young plants crowd each other, turn them out of the pots, and cut off the tap root of each. They may then be either potted or planted in the open ground at pleasure. The only further culture they require is weeding, watering, and cutting off the flower-stalks as soon as the petals drop off. By this means the plant will not waste its strength in forming seed ; fresh shoots will continually grow ; and the same plant will be in full bloom from June to October.

Pelargoniums. The flower-stalks should be cut off, as recommended for the lupine ; which will very much lengthen their time of flowering, and greatly conduce to the vigour and neat look of the plants. The same may be said of the dahlia, scabious, rose-campion, and, indeed, of all sorts of herbaceous plants.

Georginas. The roots of the georgina should be planted in pots about the latter end of February, and, if possible, placed under a hand-glass, or in a frame. They may be planted in the border, about the beginning of June. The compost for them should be three fourths sand ; and but little water should be given them, otherwise they will grow to an immense size, and be destroyed by the frost before they can bloom. It may be as well to plunge pot and all into the ground.

By the above it will be seen that the chief peculiarity of my mode of culture is cutting off the flower-stalks as the petals drop. I must beg also to remind the London horticulturist of the great benefits of using a garden engine to wash off the soot.—*Mattheus Sylvaticus. April, 1828.*

The Dividivi (Cassalpinia Coriaria).—In the month of June, 1829, I sent seeds of this plant to Dr. Bancroft, and I have lately been gratified by a letter from Mr. M'Fadyen, the scientific ex-director of the botanic garden at Jamaica, dated the 3d of September, 1831, from which the following extract will be satisfactory :—“ In several situations we have succeeded in raising the plant from the seeds which you were kind enough to send us (viz. in 1829). I have two very healthy plants at Hope Estate, one of which is just coming into flower, and the other is preparing ; so that in a short time we shall have it in our power to try the experiment on a larger and more satisfactory scale. Like its congener, the *C. pulcherrima* (Barbadoes flower-fence, or doodle-doo), it would appear to be adapted to flourish in the hottest and most parched of our plains.” This opinion perfectly tallies with the account I lately received from Carthage, and shows more strongly the immense value of its introduction into our colonies ; while his account fixes the age at which seedling plants begin to flower, at about two years, or perhaps thirty months upon an average : the fact deserves to be recorded in your Magazine for general information. The pods of this tree, besides their utility in the arts, manufactures, and medicine, as a substitute for galls, are greedily devoured by cattle ; and, in times of scarcity, furnish a valuable provender for them. The mean produce of tannin from 60 grains, as deduced from the results of two experiments, is 6·625 grains ; while the mean produce of 60 grains of the best Aleppo galls was only 4·625. Hence, taking 80s. per cwt., or 80*l.* per ton, as the mean value of galls (estimated from the prices in the *Prices Current*), the par of value of a ton of dividivi may be found by the following proportion :—

As 4·625 : 6·625 :: 80 : 115·2433, or 115*l.* 4*s.* 10¼*d.* sterling; a price which, taking the mean annual produce at 30 lbs. each ton, and allowing 222 tons to the acre, gives a total produce of 2·97322 tons, worth at the par of value, 342·643*l.*, or 342*l.* 12*s.* 10¼*d.*: a return from ground not otherwise worth 6*d.* per acre, which does not yield in amount to that of sugar, without a twentieth of its expense and hazards. I remain, Sir, yours, &c.—*William Hamilton. Oxford Place, Plymouth, October 20. 1831.*

Cactææ.—Our collections are now, by the zeal of the botanists in the New World, beginning to be well stocked with the species of this curious and highly interesting family. At one time, the hotter parts of that vast continent were alone supposed to afford them: but from the latitude of Mendoza (33° S.), and at a considerable elevation above the level of the sea, Dr. Gillies has supplied the Glasgow and other botanic gardens with no less than twenty-two species; all gathered within the distance of a morning's ride from that city; while in North America, Messrs. Douglas, and Drummond met with cactuses between the parallels of 40° and 50°, in the Rocky Mountains: whereas, Professor Schouw has scarcely extended the region of the tribe beyond the tropics. (*Dr. Hooker, in Curtis's Botanical Magazine for October, 1831, tab. 3107.*)

Brugmánsia suavèolens.—Sir, Having seen in your late Magazine an account of the *Datura arborea*, now called *Brugmánsia suavèolens*, I am desirous of giving you some further account of that most magnificent plant. I planted one three years ago, within a pit in a lofty conservatory, which grew most rapidly, and bloomed the second year: it increased in growth, and in the third year it kept in bloom till winter; and my gardener picked up the flowers that fell from it, amounting to *eleven hundred and seventeen*. It has still several buds on it, ready to bloom when spring advances. This beautiful plant is fit only for a pit in the conservatory; being of too luxuriant and rapid a growth for a garden pot, in which it will never blossom to advantage. It is easily propagated by cuttings; and, when visited by night, the sweet perfume which its blossoms emit is highly grateful.—*R. C. H. Stourhead, Feb. 1831.*

Georginas, their sportive Variation in Colour from Seeds.—In the spring of 1831, Mr. Lord, florist and seedsman, Bury St. Edmunds, sowed seeds of Douglas's *augusta*, which, as it will be remembered, is of a shaded rosy colour. From these seeds plants arose, which, on blooming in September and October last, displayed respectively the following colours: striped red, dark crimson, dark lilac, rose, light crimson, shaded crimson, light scarlet, purple, maroon (?), bright crimson, salmon-coloured, dark red, one of a very dark colour something like *púlla*, and one of the same colour as *mutábilis*. From scarlet turban Mr. Lord has raised several different shades of scarlet, crimson, and lilac; and one plant with blossoms of a red colour. From *coccínea supérba* he has raised a crimson, purple, red, scarlet, orange scarlet, light lilac, and a dark crimson. Mr. Barrett of Hardwicke, close by (raiser of those superb georginas, Barrett's Susanna, and Barrett's King), has informed me that he has seen several georginas, raised from one head of seed, and that of these seedlings part had white flowers, the remainder yellow flowers. The grower would not inform him from which particular variety they were raised.—*Henry Turner. Botanic Garden, Bury St. Edmunds, October 1. 1831.*

Sportiveness of the Species of Salpiglóssis.—Dr. Graham observes (*Edinburgh New Philosophical Journal for Oct. 1831, p. 377.*):—“ I mentioned, in May, the confusion into which the species, or supposed species, of *Calceolària* were falling, by the multiplication of mules in cultivation. Another South American genus [*Salpiglóssis*] has run wild from another cause. *Salpiglóssis* seems to require no admixture of pollen to produce great variety of form: it sports into many shapes and colours from mere instability of character. I now entertain no doubt that we have but one species

in cultivation. I have now (June, 1831) flowering in the Edinburgh Botanic Garden many seedling plants from *S. atropurpurea*, which are precisely *S. straminea*, though the size of the flower varies in the different specimens. I have also seedling plants of *S. picta*, in some of which the corolla, though perfect, is not above a quarter of an inch long, and pure white; in others, the corolla never appears at all; yet, both last year and this, specimens of this description have produced abundance of seeds. I hope these blunders are excusable on the first introduction of a little-known genus into cultivation, as I myself contributed to the confusion; but the persevering in them would be without apology. I learn from my accurate friend Mr. Cruikshanks that the forms in *Salpiglossis* vary greatly in their wild state."

The case of seeds being duly produced from blossoms which have been abortive in corollas, has been long exemplified in *Viola odorata*, and *V. lirta*; although in these it usually occurs during the summer, and perhaps autumn, after their proper season of blooming, namely, the spring. *Datura Tatula* has also been witnessed by the Rev. Mr. Creed, a gentleman in Norfolk or Suffolk, to bear apetalous blossoms, which were, nevertheless, duly productive of seeds.

Although the sportiveness of the salpiglossises above named is considered not to have arisen from one kind having impregnated another, that new kinds may be generated by cross-impregnation is proved by the existence of the *Salpiglossis Barclayana*, mentioned Vol. VII. p. 597. as a hybrid from seeds of *S. picta* which had been impregnated with the pollen of *S. atropurpurea*. — *J. D.*

Additional Hybrid Calceolarias. — Professor Graham, in his description of the new *Calceolaria angustiflora* (not *angustifolia*), published t. 3094. in the August number of *Curtis's Botanical Magazine*, exhibits his reasons for considering *C. angustiflora* a species; and that it is not a British hybrid he proves circumstantially. To these reasons and remarks he adds:—"Still a continued experience of the tendency to produce hybrids which this genus possesses, renders me more and more sceptical about the title which very appreciable varieties of form have to be considered specifically distinct. In a former number of the *Edinburgh Philosophical Journal*, I noticed some mule plants which had been raised by Mr. Gardner, at Granton, near Edinburgh, by artificially impregnating some of the most distinguishable kinds of *Calceolaria*. Since that time, the same cultivator has obtained all sorts of mixtures, and blended different species into one another, through an infinity of gradations."

In our Vol. VI. p. 493, 494., an extract from Professor Graham's communication to the *Edinburgh Philosophical Journal* is given; in which the hybrid calceolarias there noticed are said to have been raised by "Mr. Morrison, gardener to Lord President Hope, at Granton." Whether the hybrids above alluded to, through some mistake in the names of the parties, be the same with those mentioned in Vol. VI. p. 493. or not, we cannot tell, nor does it much matter. If they be identical, one interesting fact remains, namely, that, subsequently to the notice referred to, *additional hybrids* have been originated in the vicinity of Edinburgh. To these, for the sake of conspectiveness, may be added the hybrid mentioned in p. 510. of Volume VII. At the show, July 5., of the London Horticultural Society, Miss Martineau exhibited "a *Calceolaria* raised from seed of *C. Fothergilli*, fertilised by *C. corymbosa*." At the exhibition on June 21., Mr. James Young produced "some fine specimens of hybrid calceolarias." Of these report has more than once reached us, and attested them most beautiful; but an advertisement in our August Number informs us that the majority of these are identical with those above named, Messrs. Young having "become the exclusive proprietors of the fine hybrid calceolarias raised in Scotland, and partly described in the *Gardener's Magazine*, Vol. VI. p. 494." Of these Messrs. Young offer five distinct varieties, a

plant of each, and a plant of *Calceolaria Youngii*, for two guineas. *C. Youngii* is a hybrid of great magnificence, and is figured in the *Botanical Register* for October (1831), tab. 1448., whence we learn, "it was raised last year from [seed of] a plant of *C. arachnoidea* impregnated with *C. corymbosa*." Its blossoms are of the size of those of *C. corymbosa*, their ground-colour yellow, with a large deep purple spot upon the centre of each inflated slipper or lip; creating a contrast, by the vivid richness of the colours, that is singularly striking and beautiful. *C. Youngii* in habit appears to assimilate closely to *C. corymbosa*, and to have obtained little or none of the caulescence of its female parent, *C. arachnoidea*. The *Botanical Register* contains the following directions for the successful cultivation of the superb *C. Youngii*:—"It grows freely in rich soil, and is increased by division of the roots. It requires an airy situation in the green-house throughout the winter. Early in the spring, care should be taken to observe the progress of its growth, so as always to give it ample pot-room, shifting it as soon as its roots reach the outside; by which means much luxuriance of growth, and an astonishing abundance of flowers, are insured. But the greatest display of its beauty is to be obtained by planting it (in rich soil) in the open border, in May, where it will uninterruptedly increase in strength and splendour until October."

The height of the specimen figured is not stated; but, from a friend who saw a plant in blossom, we have learned it was 2 ft. or more in height. It will be seen (in p. 509. of Volume VII.) that Messrs. Young have succeeded in growing *C. corymbosa* itself to the height of 3 ft., by treating it with manured water; and it is probable that, by the same means, *C. Youngii* even may be so invigorated and magnified as to farther enhance its excellence. Besides the hybrid calceolarias above mentioned, Mr. Dennis has raised one or two; and we have heard that there are others about. We shall be happy to receive accounts of them.

"For a long time [Professor Lindley remarks, *Bot. Register*, t. 1454.] the only colours that were known to exist in calceolarias were yellow or orange. The first purple kind that was raised, *C. purpurea*, is a plant so impatient of cultivation, that it still remains extremely scarce; but *C. arachnoidea* [the second purple one, and which is almost hardy] is not only a common ornament of all choice gardens, but has become the parent of many very remarkable hybrids."

On the culture of the shrubby calceolarias, it is needless to remark their affection for a warm humid atmosphere. Mr. Thomas Bridges of Valparaiso, collector and vender of the productions of nature there, in his first letter thence, a few years since, remarked that in his earliest rambles he found the shrubby calceolarias thriving and luxuriating in damp situations at the bases of the hills about Valparaiso. — *J. D.*

Narcissinean Plants having been long peculiar objects of my attention, and having, under the auspices of my employers, Messrs. Young, been graciously permitted to form an extensive collection of these precocious and fragrant beauties; and as among them exist new and noble species, amply testified in the recent monograph of my learned friend A. H. Haworth, Esq., (a second edition of which is just published with an English preface, embracing a historical view of the tribe and a detailed mode of culture, thereby rendering it the fullest and best account that has hitherto appeared,) I hereunder append the names of a few of the rarer or more interesting kinds, which yielded their flowers in fine strength and consequent beauty during the past season:—

A'jax Sal. and Haw.

nānus *Haw.*

ālbicans *Haw.*

tortuōsus *Haw.*

cérnuus *Haw.*

A'jax Sal. and Haw.

cérnuus β flore plēno.

serrātus γ rādians *Haw.*

lobulāris *Haw.*

β ? amplicorōna *Haw.*

A'jar Sal. and Haw.
cámbrius Haw.
máximus Haw.

Ganymèdes Sal. and Haw.
cóncolor Haw.
striátulus Haw.

The subgenera (for such alone do I esteem them) *Pllus*, *Ganymèdes*, *Diomèdes*, and *Trós*, are certainly the most rare and beautiful of their numerous affinities. They succeed best (particularly *Ganymèdes*) in a pure loamy soil in an open but warm situation. The two species of *Ganymèdes* cited above flowered with more than ordinary vigour, and are now very promising for the subsequent development of their graceful forms.

Diomèdes Haw.
Maclèayii Penny.
Sabini Penny.
Trós Haw.
poculifórmis Haw.
galanthifólius Haw.
Quéltia Sal. and Haw.
semipartita Haw.
Philógyne Sal. and Haw.
heminàlis Haw. β plu-
riflòra Haw.

Hermione Sal. and Haw.
biscrènata Haw.
perlútea Haw.
lactícolor Haw.
crispicóròna Haw.
Helèna Haw.
grácilis Haw.
Narcíssus L. Sal. and Haw.
ornátus Haw.

With your permission, after the ensuing flowering season, I shall transmit for your valuable work a complete enumeration of the species and varieties, probably amounting to upwards of 150, cultivated here; with some observations on the validity of the species, and more extended directions for their successful cultivation. — *George Penny, A. L. S. (heretofore Alpha). Epsom Nursery, Dec. 19. 1831.*

Perfect Seeds and Culture of Láthyrus grandiflòrus. — Sir, Having trained the magnificent pea, the *Láthyrus grandiflòrus*, against a wall with a south aspect, in the expectation that such treatment would conduce towards perfecting its seed pods, an occurrence rarely, if by any chance, I am told, ever happening in this country, I have to state, that, although the plant grew most vigorously, attained the height of 9ft. and upwards, and was covered by a profusion of fine bold flowers, still there was no appearance of fructification going on. The blossoms, after a certain time, withered, dropped from their flower-stalks, and carried the germ, &c., along with them. On examining the flowers, I found the keel to all of them to be considerably distorted at the part which protects the stigma; so much so, as to entirely preclude the possibility of the pollen being brought into action, towards perfecting the fructification of the embryo pod. I introduced the point of a knitting needle into the opening of the keel, and slightly pressed upon the underside of the flower till the stigma and anthers protruded; and at this point, provided the flower was sufficiently mature, I found the anthers to discharge the pollen pretty freely. When this took place, I withdrew the needle, and had the satisfaction to find the greatest part of the flowers so treated leave healthy germs behind, firmly fixed to their respective flower-stalks: and from their present progressive appearance, I hope to have the pleasure of gathering perfect ripened pods this season. I am, Sir, yours, &c. — *G. C. Masham, Yorkshire, July 11. 1831.*

A sketch of the pods, exhibiting their promising appearance on the 11th of July, accompanied this our correspondent's obliging communication. We omit the sketch, as it will be sufficient to remark that the most forward pod was 3 in. long, and of an elegant figure. We have, however, previously known of three pods being produced in a natural way by plants of this superb pea; but are, as our readers will be, obliged to our correspondent for pointing out a means by which they can, by a little artificial aid, be so readily obtained. Its barrenness in seeds is, however, less a matter of regret, in consequence of its numerous, spreading, sprouting, subterraneous suckers, by which it can be speedily multiplied to any extent.

Smith, and probably other writers also, seem to consider it almost an axiom that those plants which increase numerously at the root are more or less barren in seeds; and this view has many facts to support it, and seems consistent with our usual experience in physiology, where we witness that a particular appropriation of energies to one part of a plant leaves the other parts impoverished; a doctrine very familiar to the cultivators of fruit. The view also harmonises with a beautiful economy frequently observable in nature, which, while it effects all needful ends, does nothing superfluous.

We will name two illustrative instances, to set our young friends thinking. *Nastúrtium sylvéstre*, which increases abundantly by its suckers, has its seeds "very sparingly perfected;" and *N. amphíbium*, a plant increasing at its roots most prodigiously, has its seed-pods usually small and abortive. We have cited these instances from Smith's *English Flora*, but could supply some from our own observation. Smith, in his *English Flora*, vol. iii. p. 195., says of the *Nastúrtium amphíbium*, "This plant is noticed by the celebrated M. Chateaubriand, in his account of England, for its wonderful powers of increase by root. He observed it in the river near Beccles [Suffolk], where he long resided as an emigrant; and his rather florid description has excited wonder and curiosity in many, who daily, perhaps, pass over without regard several no less interesting works of their Creator."

Instances not a few, refractory to the above view, can also be cited: as one, we may name the strawberry, which increases numerously by its prolific stolonies, and also plentifully by seeds. It applies strictly, nevertheless, in the case of annual and biennial plants, which, being devoid of all radical means of increase, have this defect compensated by their astonishing seminal fecundity. The Canterbury bell-flower, Virginian tobacco, Indian corn, and annual sunflower, are familiar examples of this arrangement.

Some plants which produce splendid flowers are more or less difficult of cultivation. Not so *Láthyrus grandifórus*. Almost the only condition on which its perfect success depends is early removal. This should be performed as soon as ever the herbage begins to turn yellow, which is at the close of August, when the plant is at rest. Removed at this time, autumnal growth has the good effect of so establishing it, as to enable it both to resist the winter's frost, and to blossom the succeeding summer. When removed, as it usually is, at any time between February and May, it receives such a check to its growth, which is then going on, that one, and sometimes two, summers are gone before it acquires sufficient vigour to blossom. — *J. D.*

HORTICULTURE.

Mr. Seymour's System of training Peach and Nectarine Trees. (Vol. I. p. 130. and Vol. II. p. 295.) — We have been favoured with two communications on this method of training the peach, &c.; and an account of the trees under Mr. Seymour's own management, as they appeared last summer. "It is impossible," says the writer, "for the pen to do the trees justice; nothing but a personal view can suffice. The health and regularity, the profusion of flowers which covered the mother branches from the stem to the extremities, were truly astonishing. One tree, a Bourdine peach, attracted particular notice; it extended 47 ft. on a 10 ft. wall, and its branches were literally covered with bloom on every part. Since the time I saw it, I have understood from Mr. Seymour that he has thinned off from this tree 3540 green fruit, leaving an ample crop to come to perfection. As the process has already been described in your Magazine, it is unnecessary for me to repeat it here; but I may add that it is entirely Mr. Seymour's own, he never having had a hint, verbal or written, on the method, from any one. The tree in the garden of the Horticultural Society at Chiswick, said to be trained according to Mr. Seymour's system, is not a fair speci-

men of his management, nor is it a suitable tree to receive it. The main branches are not placed near enough at bottom, and the stem is too long; so that this tree will always remain out of due form. There are maiden trees planted and intended for Mr. Seymour's method, with which they may succeed, especially if they attend to laying in the young shoots in proper time. Of this I have no doubt, as the person charged with the execution has a competent knowledge of, and much approves, the system." Though this method of training the peach, is similar in principle to the *mother-branch-training* of the French gardeners, described in various horticultural works published in that kingdom, and particularly by Mr. Smith in the *Transactions of the Caledonian Horticultural Society*; yet originality cannot be denied Mr. Seymour in his *early stopping* the summer shoots intended to bear fruit the following year. His practice in this is entirely new, and may, therefore, be called the *spur-bearing*, with as much propriety as it has been called the *mother-branch-bearing*, system. — J. M.

Destroying the Apple Bug (Aphis lanigera). — I have found oil and soot well mixed together and rubbed in with a brush, an effectual cure for the *Aphis lanigera* on apple trees: for though it has appeared again on the same tree, it has never attacked the same parts which had been once well saturated with the mixture. — B. B. Sept. 6. 1831.

Hardihood of hybrid Melons, &c. — Sir, My purpose now is to afford you another instance of the greater hardihood of newly originated hybrids, in corroboration of your remark (Vol. VII. p. 696.); but I have rather attributed their ability to resist unfavourable circumstances to the greater degree of vigour observable, than to any specific hardihood peculiar to the individual; for I do not consider that they will retain the property after being frequently reproduced from seed, uninfluenced anew by foreign fecundation. I have this summer met with better success in my cultivation of melons, in an unprotected state, from the seeds of hybrids obtained by cross impregnation the season previous, than with old varieties. The offspring of three different hybridisations (one more especially, of which the parents were the two most dissimilar varieties I could select) each yielded more ample and finer produce than any one of between twenty and thirty established varieties, under no other dissimilar circumstances than that some of the latter were raised from older seed. I send you copies of two letters received from the secretary to our Horticultural Society, in allusion to a melon I had sent him, which was raised from seed, and grown throughout in the open air and common ground. The second letter was written in consequence of my expressing a doubt as to his sincerity, and intimating that he had been lavish of his praise merely to yield me gratification.

“ Worcester, Sept. 27.

“ Sir, I beg to forward you the melon seed, as requested, and to state that the melon which you kindly presented me was by far the finest-flavoured I ever eat, and this was the opinion of others who tasted it. I consider it far superior to those grown by heat. Yours, &c.

“ To J. C. K., Esq.

J. EVANS.”

“ Worcester, Oct. 1.

“ Sir, The colour of the melon was deep orange; and I assure you that what I said respecting its flavour was not exaggerated; especially when I inform you that a person who had frequently tasted melons grown in pits, &c., but would never partake of them, nevertheless eat plentifully of the one you favoured me with, and said it was far superior to any he had ever tasted.

“ Yours, &c.

“ To J. C. K., Esq.

J. EVANS.”

The melon in question weighed 2½lbs.; the largest of that sort weighed a quarter more; but of other hybrids I cut one 5lbs. 12oz.; and yet others, with the assistance only of a garden hand-glass, attained to 4lbs., 5lbs., and even 6lbs. On reference to the account of the meeting for September, you will note that I there received two prizes for such. (See p. 121) I will next year, provided I am equally fortunate, send you a fruit, to enable you to judge for yourself. Some that I eat myself were equal to the best produce of my frames ripened in July and August; which latter, all who tasted, and, among others, an Eastern traveller, avowed they had never

seen exceeded. I might add that the fruiterers were willing to give the market price for the fruit thus grown in the open air. I am, Sir, yours, &c.
— *J. C. K. Levant Lodge, near Worcester, Dec. 1831.*

Purple Egg Plant. — This seems to be the only variety cultivated abroad for culinary purposes. I have never once observed even a solitary specimen in any of the markets of Italy of the white variety, and yet I do not perceive why the latter should not be as good as the former. It is dressed precisely similar to "vegetable marrow." A celebrated traveller informed me that he was once present at an Oriental entertainment, where a growing egg plant was introduced: and the fruit, pendent from the tree, had undergone various culinary processes, by the dexterous ingenuity of the Chinese: some were boiled, others roasted, &c. — *J. Murray. August, 1830.*

Culture of the Tomatoes (Lycopersica.) — I do not think the tomato, or love-apple, is so much cultivated in this country as it deserves; in some places possibly it may never ripen thoroughly, but even in an unripe state it makes an excellent sauce, like apples or gooseberries, for roast meat, such as pork or goose, its acidity being more pleasing than that of apples; and, when fully ripe, tomatoes make an excellent store sauce, for which I send you a receipt (Vol. VII. p. 698.), and I think they might be found to keep as well as some other of our more delicate fruits. They grow easily, after being raised in a hot-bed; and, from the peculiar odour of their leaves, do not so much attract that great enemy of our transplanted seedlings, the slug. It is a mistaken notion, too, that they will only thrive in this country against a wall: they are better away from fruit walls, the trees of which they materially injure, and will thrive as well, when transplanted on a common bed, straggling in their devious course like vegetable marrows, or any other of the gourd tribe. Indeed, they may extend to any length, from their propensity to strike root at every joint; and I have, even in the confined limits which I could afford them in my own scanty garden, gathered as many as a peck in a morning.

Having mentioned the slug as the great enemy of our gardens, I will just hint at the mode I take to destroy them, and which I have found very effectual; of course, such a plan is hardly available any where but in a small garden, except by broad-cast, which is not so certain in its results. Every morning and evening, or after rain, I send a boy round the different borders and beds with a small bowl of salt, a few grains of which he drops on every slug he finds; and it is really astonishing in how short a time a sensible diminution of the evil is effected. The above fasciculus of hints is much at your service. — *B. B. Sept. 6. 1831.*

The Scarlet-runner Kidneybean was a perennial plant in my father's garden at Kitwell House, Worcestershire, in 1810, 1811, and 1812. What became of it afterwards I do not know, as we then left the place, and let it for some years. — *J. W. L. Bayswater, August 25. 1831.*

The Scarlet Runner a Perennial. — Sir, Since you published the instances in Vol. VII. p. 485., I have discovered another. Mr. Stephen Watts, Kensington Gravel Pits, about eight years ago witnessed it, as well as many of his neighbours. His garden is bounded on the west by the blank back of a house, which fronts the other way; consequently, the wall, which is 20 ft. high, presents its eastern face to his garden. Along this face, at a few inches from its base, he planted a row of scarlet runners; the haulm, herbage, &c. resulting from which were not displaced till the following spring. The man Mr. Watts employed in digging the ground left, by accident or slovenliness, three root-stocks of the scarlet runner less disturbed than the rest, for three grew again in the second year. Of these three, two were fair plants, not much exceeding in size a strong plant in its first year's growth; but the third plant was a prodigy: its branches spread over a space of 6 ft. at a few feet from the ground, and then gradually tapered off as they ascended, and the central one or more of them actually reached the

summit of the 20 ft. wall. The outline figure of the whole plant was that of an acuminate cone. The curiosity of his neighbours was highly excited by the marvellous size of the plant, and by his frequent use of a ladder to gather its legumes; and when informed of the plants being in the second year of its growth, Mr. Watts received liberal offers from several for seeds of his Everlasting Scarlet Runner, as they termed it.

It may be well here to notice that the term "everlasting" is, in other instances, applied to perennials by persons unfamiliar with plants. In a village in Cambridgeshire, known to me, and possibly in the county generally, the *Heliánthus multiflorus*, a well known perennial, is called the Everlasting Sun-flower: this name, without a question, being designed to contradistinguish it the more palpably from the annual species, *Heliánthus ánnuus*.

The power of spreading, and extensive growth, evinced in the scarlet runner above, exceed every instance previously known to me, and associate instantly a recollection of the close affinity which the genus *Phaseólus* bears to the genus *Dólíchos*. The power of extension possessed by some species of *Dólíchos* is most prodigious. I am, yours, Sir, &c. — *John Denson. Bayswater, July 31. 1831.*

The Sea or Wild Cabbage at Dover. — Sir, Herewith I send you some seed of the sea or wild cabbage (*Brássica oleràcca Eng. Bot. pl. 637.*), no doubt the original parent of many of our garden vegetables. The plant, if not rare, is yet, I believe, exceedingly local. Here it is evidently indigenous, growing in the greatest profusion on the chalk cliffs, both on the precipitous and accessible parts; but I do not recollect to have seen it elsewhere, save on the cliff near the sea, immediately under the town of Penzance, where it grows more sparingly; and in that situation its character, as a native plant, is somewhat more dubious, occurring, as it does only, so far as I observed, under the town; a situation which might lead one to suspect that the plant may possibly have sprung from seed escaped from a garden. My reason for sending you the packet of seed, is the hope that you, or some of your friends, may try (as I mean to do myself) what may be the immediate effect, if any, produced on the plant by cultivation. If (as may be expected) it be at all improved by cultivation, or if it remains just as it is, it cannot but prove, I think, a valuable addition to our gardens; for, even in its wild state, it is as delicious a vegetable as I ever eat. I shall perhaps raise a smile on the faces of some of your blue-aproned readers, when I state that I have had the young tops of this wild cabbage boiled and served up at table many times this month, gathering, of course, only the very eyes or young shoots, and that they have afforded a more delicate dish of vegetables, at least of the cabbage kind, than, I believe, can be purchased in the market at this season of the year. In the spring they would probably be still better, as that, no doubt, must be their proper season. The only wonder is that the sea cabbage is not greedily gathered by the inhabitants, as well for private use as for sale. But such is human nature, that we are ever apt to neglect and despise whatever is common and has always been before our eyes; and probably, had I myself been a native of this place, instead of an accidental visitor, I might never have thought of gathering the wild cabbage for the use of the table. All the productions of nature, doubtless, have their use, if we could but discover it; and the knowledge of this, and the turning of any common thing to good account, I always consider as a point gained. Such is my opinion of the excellence of the sea cabbage as a culinary vegetable, that for the benefit of mankind I think its growth ought to be encouraged, and its seed scattered on all cliffs and waste places, where it would be likely to succeed. I should mention, that in a native state the wild cabbage varies in its foliage and general appearance almost as much as the ordinary garden cabbage differs from the Savoy or

the broccoli, which latter vegetable it much resembles in its general aspect. Specimens also frequently occur very strongly tinged with a purple colour. Yours, &c. — *W. T. Bree. Dover, Aug. 29. 1831.*

P.S. Since writing the above, I have ascertained that the use of the sea cabbage, as a culinary vegetable, is not unknown to the inhabitants of Dover. — *W. T. B.*

The seed received has been sent to Mr. Charlwood for distribution. — *Cond.*

Preventing the Sprouting or Germinating of Store Onions during the Winter and Spring. — Sir, As the season has now arrived in which most gardeners have already taken up their store onions, or are about to do so, allow me to suggest a plan for preventing that sprouting or germinating principle which so often renders them inferior even at an early period, and almost invariably useless at a later one, as an ingredient in our cookery.

As, however, it is not a plan of my own suggesting, but was mentioned to me by an old lady who had seen it practised in Holland, it is possible it may be known to many of your readers; though, as far as my own experience extends, it is practised by none.

It is simply applying a heated iron for a few seconds to the nozzle of the onion whence the roots protrude; and though I am sorry to say I have no onions this year on which to try the experiment, they having been swept from me by some petty depredator, still I can testify from my own previous experience that it is an efficient mode of preserving them. — *B. B. Sept. 6. 1831.*

An Alternative against the Club in the Roots of the different Species of Brássica. — The following may probably prove of use to some of your numerous readers, who have their crops of cauliflowers, broccoli, &c. annually destroyed by this as yet incurable disease. Some time ago I had the charge of a garden that was more than commonly subject to the club. I was of course induced to try every means in my power to find out a remedy. I visited many gardeners in the immediate neighbourhood, who had the same disease to contend with, but none of them could give me the least hint of either preventive or alternative. I next searched your *Encyclopædia of Gardening*, but could find no preventive mentioned in it; and the only alternative I could find noticed was, to take up the plants and cut off the clubbed part of the roots and then replant them. In this case, however, although the clubbed part be cut off, some of the grubs (for grubs they certainly are that cause it) still remain in the roots, or easily enter at the wounded part, and continue to prey upon them, so as to keep them always in an unthriving state. It is evident that the grubs commence their work of destruction when the plants are young, while the roots are tender and easily penetrable; and, when once they get into the tap roots (which they always begin with first), it is impossible to eradicate them without cutting the roots entirely off, which would destroy the plants also. I therefore resolved upon trying the following experiment:—

I procured from a sale garden some good strong healthy plants, the roots of which had become hard and woody, so that the grubs could not easily penetrate them. These I planted in the usual way, and kept them well watered for a few days. In two or three weeks they began to grow most luxuriantly, and ultimately far surpassed my greatest expectations; indeed, I can truly affirm that there was hardly a failing plant among them. The sorts I planted were purple and white broccoli, Savoy, Brussels sprouts, and cabbages.

To complete my experiment I planted on the same day, and in the same sort of soil and situation, plants of all the above kinds, raised from seed sown in the same garden; and the result was, that two thirds of them went entirely off, and the remaining part continued sickly, and were little worth in the end. I regret, for the sake of the experiment only, that I

had not an opportunity of trying it another season, to have been thoroughly convinced of its utility. However, some of your readers who are troubled with the club will probably give the experiment a trial, and communicate the result to your valuable Magazine.

In addition to the above, I should recommend that the ground intended for planting the different sorts of *Brássica* upon be trenched two spits deep in winter, and a sufficient quantity of manure added between the first and second spits; and, previously to planting in spring or summer, to have a good dressing of quicklime and fresh loam, to be dug in, but not deep. But I am afraid that I have taken a very roundabout way of telling those who have gardens subject to the club, that, instead of raising their own cabbages from seed, they must procure clean established plants elsewhere. I am, Sir, yours, &c. — *Brássica*. Nov. 1831.

To produce young Potatoes for the Table during Winter, in the open Air. — The varieties of the potato which I plant are the early kidney, early Ross, and early Graham. At the time of housing potatoes, I select a peck of the largest of each kind, and lay them on the ground as close as they will lie (not heaped up) one beside another, which gives me the size of the pit where I keep them till the time of planting. I dig this pit 5 ft. deep, and lay the potatoes as close as above mentioned in the bottom of the pit, covering them with dry sand 4 in. thick, and then filling up the pit with earth, and treading it very firm to exclude the air. Let them remain in the pit till the middle of July, and then take them up, and pick out all the eyes except a good one in the middle of the potato. When planting, keep the eye uppermost.

They will answer best in a south border that has a little slope, to throw off the rain. The soil should be pretty rich, but no dung should be added; for I have found by experience that, if the soil is in good condition, it will grow potatoes large enough for the table, and they will have a better flavour than they would with dung.

Plant them 1 ft. from each other in the row, 3 ft. between the rows, and 2 in. deep. Take great care in earthing up the stems afterwards, as they are more tender than if they were planted earlier. High winds are very injurious to them if not earthed up in due time. They require nothing more but to be covered with long litter at the end of October, to preserve them from the frost. They are dug up for the table as wanted. I am, Sir, yours, &c. — *Robert Arthur*. *Jardine Hall*, Nov. 25. 1831.

Carrots may be grown in Peat [not Heath Mould]. — The garden of Sir John Hay, Bart., at King's Meadows, Peeblesshire, is situated upon a subsoil of cankering gravel mixed with a substance having a near affinity to ironstone. This I detected by means of the water in the neighbourhood of the garden, which I tested with the tincture of galls, and other chemical reagents used in analysing chalybeate waters. Every test used showed the presence of iron in a high degree, by the black colour given to the water upon the addition of any of the tests. The soil is light and sandy, but produces vegetables to equal, if not excel, any in the county, carrots excepted. Mr. Sherare (the gardener) has had the garden under his management for above thirty-one years; and during that period he has never obtained a crop of carrots worth any thing, although he had tried every means which his judgment could suggest, or others recommend. After so many disappointments, he had for many years past considered his soil as incurable, and totally unfit for the cultivation of the carrot.

Last autumn, being engaged in preparing a suitable soil for evergreens and American plants, the thought struck him that he might try the effects of peat in growing carrots. The peat used was that taken from what in Scotland is called a moss hag; that is, pure decayed vegetable matter, without any mixture of sand, &c. The ground was trenched about 2 ft. deep, with the addition of a little dung. The first frost was taken advantage of for the purpose of wheeling on the peat, which was laid regu-

larly on about 8 in. thick, with a slight dusting of lime. In this state it lay till spring, exposed to the frost, when it was dug in. The seed was sown in the usual manner, and at the proper time for producing a main crop. Nothing out of the common routine of culture was given during the season. I have since received a letter from Mr. Sherare, in which he states his success to have been most complete. I have also received another letter from a man of much experience, an eyewitness of the experiment, who remarks, "that not only is the crop better than any in the county, but greatly superior to any he ever saw in point of size, shape, and cleanness." I am, Sir, yours, &c. — *Ephëbicus Horticultor*. *Bedford Nursery*, Dec. 10. 1831.

AGRICULTURE.

Ruta бага, or Yellow Swedish Turnip.—An excellent variety is now growing on the farm of a friend of mine in this parish, which, in point of form and quality, and, I believe, of weight per acre, as far exceeds any thing of the kind I have ever seen before, as any cultivated vegetable exceeds the wild sorts. You will be somewhat interested in this matter when I tell you that the seed was procured from, and strongly recommended by your friend and constant reader Mr. George Fenn, nursery and seedsman, of Beccles. A part of the field had already been sown with Swedish turnip seed, raised from transplanted stock by a neighbouring farmer; but, as soon as Mr. Fenn's seed arrived, the sowing of the first-mentioned seed was stopped, and the remainder of the field finished with his stock. There was no great deal of difference in the number of plants, except that Mr. Fenn's came up quicker, and, though sown last, were first to the hoe. At the present time, a stranger, judging of them from the road, would see considerable difference between the two stocks; and perhaps, from its greater rankness and heavier



top, give the preference to the old sort. (*fig. 25.*) But his opinion would change on closer examination: he would find the plants of this stock, in-

stead of *appling* (as we say) kindly, wasting their strength in endeavours to form, not a bulb, but an unsightly and unprofitable stalk, as shown in *fig. 25.*) : in fact, bearing more the character of a cabbage than of a turnip, and very coarse and fibrous at the root. Such are what I call the old stock, the sort most commonly grown about here, and the seed of which was produced from transplanted roots selected by a careful farmer. Now, what are Mr. Fenn's? Certainly, the handsomest turnips of the sort I ever yet saw; and if I said of *any* sort, I do not know I should be very wide of the mark. I have in the sketch (*fig. 26.*) endeavoured to give an idea of their general



form; and a comparison with *fig. 25.* will at once show their superiority.

Here is no running to stalk, nothing of the mongrel about it; but a round handsome bulb, with a roughish yellow skin like a melon, and of a fine rich quality when cut into. An old labourer observed to me: — “Lawk, Sir, what beauties them new tannups dew grow, surelie! — why, they look more liker a melon than a tannup. They haen’t got no fifiers [fibres] at the roots, like them t’other.” And the old man was right.

“Look at this picture and on that.”

One is comparatively clean and free from fibres, whilst the other is like an ash tree in miniature. Of the comparative weight of the two crops I should give a decided preference to Mr. Fenn’s; but, even were the weight equal, I should certainly grow the latter on account of their superior quality. It may be said that I have caricatured my likenesses; at any rate, that I have selected the handsomest of one stock and the ugliest of the other; but it is not so: from Mr. Fenn’s turnips I could have chosen thousands equally handsome; from the others, thousands equally ugly. One of his plants, I must remark in conclusion, at this time measures 2 ft. 4 in. round the bulb: nor has it yet attained its full size. They are a sight worth seeing, and are very different from any thing of the kind I ever saw before. I give you my name,

because I think anonymous accounts of these matters are very often, and perhaps very justly, open to suspicion; and because, as a disinterested person, I can say more of them than, perhaps, our friend Fenn would feel disposed to do. I am, Sir, yours, &c.—*S. Taylor. Geldeston, near Beccles, Suffolk, Oct. 1. 1831.*

From some experiments lately made by Mr. Sinclair, the results of which are given in the *Farmer's Journal* of Jan. 2. 1832, it appears that the Swedish turnip, unlike other turnips and the mangold wurzel, produces most saccharine matter when the roots are large: a powerful argument in favour of its culture in preference to the plants mentioned. In the same journal, notice is taken of the great success of Mr. G. Mills at Cranbrook, near Ilford, in procuring heavy crops from transplanted plants; a practice long known in Scotland. Mr. Mills's success, however, has been so great, that he is going to publish a book upon the subject. — *Cond.*

ARCHITECTURE.

Bridge-building. — It appears that the New London Bridge has sunk as much as 7 in. on the western side, and about 15 in. on the eastern side. Mr. Savage, an architect who has paid great attention to the subject of bridges, and who circulated a pamphlet in 1823 disapproving of the late Mr. Rennie's plan, assigns, as a cause for the sinking, the use of too many piles under the piers. The foundation, he says, is a bed of dense clay, which is not mended, but injured, by piling. At the building of Waterloo Bridge, a bed of similar clay was wholly disturbed by piling, and, instead of being rendered more secure, was raised into a sort of puff paste; in consequence of which, the security of the bridge depends entirely on the piles acting as stilts. (See Mr. S. in *Examiner*, Dec. 25. 1831.) We consider the reasoning of Mr. Savage as perfectly just, and in accordance with the arguments against the use of piles in Mr. Smeaton's works, and with his practice in the case of the Perth and other bridges. The real truth we suspect to be, that the great success of the late Mr. Rennie in all his undertakings prevented any part of his practice from ever being questioned, except by a few men of science, like Mr. Savage; and these being generally poor, or young, or comparatively little known, their criticisms were never listened to. Nothing is so difficult, in this country, as for an architect or engineer who has nothing to recommend him but a profound knowledge of his subject to procure employment. An eminent man like the late Mr. Rennie not only carries every thing before him during his own life, but leaves a sort of hereditary influence to his family, which secures to them that employment which they would probably never obtain by merit. We could name architects and engineers of first-rate acquirements, who have scarcely any thing to do; and others of scarcely any mind, who are full of employment; but time will remedy this evil, as well as many others. As the government, corporate bodies, and monopolists generally, get poorer, scientific men will have a better chance; for the force of money being wanting, the power of skill will be resorted to from necessity.

We shall probably give Mr. Savage's remarks on the design of the late Mr. Rennie in an early Number; in the mean time we would ask Mr. Savage and other scientific engineers whether sinking a caisson, and loading it with three times the weight the pier was destined to bear, would not effect a foundation as good as one obtained by even the best mode of piling? Suppose the loading to consist of regular layers of stone; and that, after all the sinking which triple the weight would produce had taken place, the courses of the loading were found not quite horizontal; the loading could then be taken down as low as the bed of the river, and the surface thus exposed be hewn to a level. This done, the permanent pier, destined to support the bridge, might be commenced in the usual manner. This idea, we believe, is expressed in detail by Smeaton, or by Belidor or some other

French author, and it is put in practice every day, on a small scale, and with different materials, by gardeners, who roll their gravel walks or approach roads with rollers which press on every part of the surface with triple the effect that men, horses, and coaches can do. In consequence of this, the walks are smooth, and the approach roads without ruts. — *Cond.*

Fire-proof Floors and Roofs. — Mr. Frost, of No. 6. Bankside, builder and cement manufacturer, has just described to us his mode of constructing floors to houses of hollow earthenware tubes and cement, combined in such a way as to form a floor as strong as one of timber, and much more impervious to heat, cold, sound, or smells. The hollow tubes are square in the section, and are made of brick earth, prepared in a very superior manner by machinery; they are placed in strata in opposite directions, and cemented by a new and very superior cement of Mr. Frost's invention. We have not time at present to enter into details; but it may suffice to say, that the floor or flat roof produced by Mr. Frost's process is in effect one flag stone (only not a fifth part of the weight of solid stone) of a size sufficient for the space to be covered. The invention appears to us of immense importance with reference to fire-proof buildings; and we shall have much to say on it in our next Number, and in our *Encyclopædia of Cottage Architecture*, now nearly ready for the press. In practice this mode of flooring and roofing will not be more expensive than the common mode, the material costing little, and the whole of the effect being the result of labour. Notwithstanding the immense importance of this invention, especially for small and middle-sized houses, we can foresee that it will be extremely slow of introduction, because it will cut deep into the trades of the timber merchant, carpenter, and plumber. It must, however, finally prevail. It is pleasing to think that, by Mr. Frost's fire-proof houses, and Mr. Witty's smoke-consuming furnaces, London might become a city of flat roofs covered with gardens of pots. We sincerely wish some man of property would take Mr. Frost by the hand; he would be found a scientific builder of many years' experience, and well acquainted with the principles of mechanics and chemistry, and their application to architecture. — *Cond.*

Mr. Frost's Cement is thus formed: — Chalk is ground very finely in a mill, and, as it is ground, mixed with water, which conveys its lighter particles to a reservoir. Clay is grinding at the same time by the same machinery, mixing with water, and conveying its lighter parts to the same reservoir. This combination of chalk and 30 per cent of clay is drained and left to evaporate to dryness. The stratum is then broken up, burnt in a kiln, and after being ground to powder, is put into casks and hard pressed. It will thus keep for any period, and may be sent to any distance. It is much cheaper than Roman cement; and has this great advantage for country use, that it requires no sand to be mixed with it. It appears to us that garden walls and cottages might be formed entirely of this cement, arrangements being adopted to have what is usually built solid made cellular. It would suit admirably for building houses in warm climates. [This and the preceding paragraph were in type in April last, before we left London on our tour, and have, unfortunately for Mr. Frost, stood over ever since. We hope, however, to make amends for the delay, by prevailing on some friend, who has the money to spare, to erect a fire-proof cottage on a piece of ground at Bayswater, which we shall point out. We hope some moneyed reader will volunteer his assistance on this occasion.] — *Cond.*

Zinc, rolled into large plates, is now a good deal employed as a substitute for lead and slates, in the roofing of buildings, both in Britain and on the Continent. The great advantage of these plates of zinc is their lightness, being only about one sixth part of the weight of lead. They do not rust, which is another great advantage, and has led to the employment of zinc pipes both for cold and hot water. (*Brewster's Journal.*) No covering is better adapted for verandas and summer-houses. — *Cond.*

DOMESTIC ECONOMY.

Cheap Beer for Gardeners and their Workmen.— Sir, I send you some receipts for cheap beer, to which, I hope, you will give general publicity, as no set of persons will be more benefited by them than gardeners and their workmen. I observe, first, that West India molasses is the best for the purpose. It is a kind of treacle, which is sold as it comes from the West Indies, and is known by a gritty substance at the bottom of the cask, more or less like sand, which substance is, in truth, an imperfect sugar. Common treacle will do as well, if the quantity be a little increased, say one pound in six or seven; but the best article of all is the coarsest brown sugar you can get; it is better than the higher-priced for this purpose; and you may use one pound in six less of it than of the West India molasses. It is, however, dearer upon the whole, though still much cheaper than malt. In making beer from unmalted barley, it is necessary to take good care not to use the water too hot, as, if it be, the barley will set, that is, become pasty, and not allow the water to drain off. Be very particular about this; a little oat chaff well mixed with the barley will go a great way to prevent this accident.

1. *Raw Barley and Molasses.* The use of raw grain with molasses, for making beer, is a most valuable discovery for the middle classes. Put a peck of barley or oats into an oven after the bread is drawn, or into a frying-pan, and steam the moisture from them. Then grind or bruise the grain roughly (not fine), and pour on it $2\frac{1}{2}$ gallons of water, so hot as to pain the finger smartly. Mash it well, and let it stand three hours. Then draw it off, and pour on every two gallons nine of water rather hotter than the last; but not boiling (say not above 180°). Mash the liquor well, and let it stand two hours before you draw it off. Pour on afterwards 2 gallons of cold water; mash well, and draw off. You will have about 5 gallons. Mix 7 pounds of West India molasses in 5 gallons of water; mix it with the wort from the barley; then add 4 oz. of hops, and boil one hour and a half. When cooled to blood-heat, add a teacupful of yeast; cover it with a sack, and let it ferment eighteen hours. In fourteen days it will be good sound fine beer, quite equal in strength to London porter or good ale. The 9 gallons of beer will cost:— 1 peck of barley, 1s. 3d.; 7 lbs. of molasses, 1s. 6d. to 2s.; 4 oz. of hops, 3d.: in all, 3s., or, at most, 3s. 6d.

2. *Malt and Molasses.* Pour 8 gallons of water at 175° on a bushel of malt. Mash well; let it stand three hours; draw it off, and add 8 gallons more water at 196° . Mash, and let it stand two hours: add 8 gallons of cold water to the grain, and let it stand three hours and a half. Mix 28 pounds of West India molasses in 20 gallons of water, and boil the whole with 2 pounds of hops for two hours. When the liquor is cooled down to 85° , add half a pint of yeast; cover it with a sack, stir it well, and let it ferment twenty-four hours. In proper time you will have 36 gallons of good ale for— 1 bushel of malt, 9s.; 28 lbs. of molasses, 6s. to 8s.; 2 lbs. of hops, 2s.: in all, 17s., or, at most, 19s.

3. *West India Molasses only.* Mix 14 pounds of West India molasses with 11 gallons of water; boil it for two hours with 6 ounces of hops. Let it become quite cool; add a teacupful of yeast, stir it up, and cover it over with a sack, to keep it warm. Let it ferment sixteen hours, put it into a cask, and keep it well filled up; bung it down in two days, and in seven days it will be fit to drink, and be stronger beer than London porter. This is the simplest of all; a washing copper and a tub, or even a large tea-kettle, only being requisite. Thus 9 gallons of beer can be made:— 14 lbs. of molasses, 3s., or, at most, 4s.; 6 oz. of hops, $4\frac{1}{2}d.$: in all, 3s. $4\frac{1}{2}d.$, or, at most, 4s. $4\frac{1}{2}d.$

A small quantity of copperas, or vitriol of iron, about as much as will lie on the point of a small knife, is in general use, to give beer a head, and make it drink pleasant and lively. It is not necessary, but it is not unwholesome in any respect. — *Y. A. B.*

ART. III. *Foreign Notices.*

FRANCE.

THE Labouring Classes in the South of France. — Sir, Having read in the Gardener's Magazine, with much satisfaction, your descriptions of the state of the peasantry and the working classes in various parts of the Continent of Europe which you have travelled over, I send you an extract from the letter of a highly gifted and intelligent lady, describing the present state of the peasantry in a part of France not much visited by English travellers. The account cannot fail to interest many of your readers. The writer of the letter is well qualified to form a correct estimate of the comparative comfort of the labouring classes in England and France, having for many years taken an active part in ameliorating the condition of the poor in her own neighbourhood, in one of the northern counties in England, where her husband is a most useful and benevolent magistrate. Yours, &c.—*B.*

“ We have traversed the banks of the beautiful Loire, visited the various old towns of Orleans, Blois, Tours, Saumur, and Nantes, and are delighted with the scenes; but I must not be topographical, when you can have your map out in a minute, and the guide-book to tell you all about them. Nantes was to have been the end of our journey, but then we heard so much of the brilliant Bordeaux; so on we came, and saw in the way the towns of Rochelle and Rochefort, besides passing through previously the interesting heroic La Vendée. Who can turn back at Bordeaux, when the Pyrenees are so near? so we took our first view of them at the pretty town of Auch, then to Tarbes, and the day before yesterday brought us to their very foot.

“ You, wrapt in your fog and your smoke, may wonder what an October course in the mountains can offer to attract; but if you could only be here and see how perfect it is, the air clear and bright, and warm as in our finest August days, the trees still in leaf, and the tints of every colour, and the outline of the hills as finely marked as if a pair of scissors had cut it. We were out from eight till four yesterday, seeing cascades, and rocks, and picturesque hamlets. The heat was almost insupportable; and for myself, I am sure this excursion is made as early as my constitution could endure it.

“ We have long ago left all the English, and are now really living in a foreign land: no more *loges royales*, no more *Elysée* dinners or *Genlis soirées*, as in our former visit to France; but in their place we have the people of the country always about us, with an opportunity of constantly speaking their language, and becoming acquainted with their habits, manners, and institutions. Cold must be that heart that can make the tour of France without a sympathy for the happiness that every where prevails. If you enter a cottage, and ask how the owner lives, the answer will probably be: — ‘*Mademoiselle, nous sommes propriétaires; nous ne sommes pas riches, mais nous sommes indépendans; nous sommes contents.*’* The beggars are very much diminished; and it is rare indeed to see any one with that starved and wretched look so common in England. This is the fruit of their sudden leap towards liberty. Primogenitureship gone, wealth diffuses itself; hereditary honours abolished, there is hope for the lowest: and then the senate, how wisely it is arranged! — to sit with the peers you must be 40, with the commons 30; and even to vote, you must be 25. Soldiers are never flogged; and the punishment of death is scarcely ever inflicted. How far are we behind! It makes me sad to think of it.” — ††. *Haut Pyrenée, Bagnes de Bigorre, Oct. 29. 1831.*§

* “ We are proprietors; we are not rich; but we are independent; we are content.”

§ It will be seen by the date that this letter was written a little before

Lower Normandy.—The situation of Bagnoles Wells reminded me much of Matlock, as I remember it 30 years ago; but it has the advantage, as a place of retirement, of having no public road passing through it, and on the whole it is on a less scale than Matlock, though the rock scenery is both bolder and finer. There is a beautiful trout stream running through the valley at Bagnoles, and abundance of fine growing timber trees situated at the bases of the rocks, and growing out of their crevices with great luxuriance. On the south, the Forest of Ardennes reaches to a level with most of the tops of the rocks; those on the north are surmounted by thriving plantations of larches, Norway spruces, Scotch pines, and cedars of Lebanon, in addition to the native woods. From the midst of these rises a belvedere, having a railed gallery nearly round it; from which a most striking, extensive, and yet rich and beautiful view is commanded of a part of the neighbouring forests, the rich vales at the foot of the hill, and an undulating well-timbered country, extending even into the departments of La Sarthe and Mayenne, bounded in the distance by the magnificent ranges of hills which cross those departments.

The *Rhododéndron ponticum* was in full blossom in the romantic valley of Bagnoles, in the middle of May, intermixed with most of our English indigenous and acclimated common shrubs and plants, which have for the most part been planted adjoining to, or in view from, the judiciously planned walks and rides; which add greatly to the interest of this solitary and singular, but beautiful, spot. At a distance of a quarter of a mile, an English kitchen-garden has been begun, with every prospect of considerable success; but the death of the proprietor has arrested its progress, and for a time injuriously affected the whole of the establishment of Bagnoles Wells. The building of the garden walls, which are at present completed only on the north and partly on the east side, is about to be resumed; and it was intended to finish the gardener's house adjoining in the course of the summer. The ground enclosed, which in quantity did not exceed a hectare of land*, is divided into exact squares by turfed walks, which are again as regularly subdivided into beds of different sizes; with their respective paths. The main walks, bordered by dwarf apple, pear, and other fruit trees, are of sufficient width to allow of a cart passing along them, for the admission of which, space for an ample gateway is left at the end of one of them; and the south side of the north wall is well clothed with healthy-looking peach and nectarine trees. Though situated on high land, the garden is well sheltered; has a gentle slope towards the south, and a beautiful never-failing stream of water running through it in covered drains which supplies a circular basin in its centre. From the cause before mentioned, which had paralysed every thing, the spring crops had

the abolition of the hereditary peerage in France. Much has lately been said in the English papers, of the misery of the working classes in France; but these accounts apply only to the manufacturers, who, after all, I believe, are in a far better state than the manufacturers in Great Britain, the price of provisions being much lower. A few years since, I saw several thousands of the manufacturers of Lyons assembled in the fields on a *jour de fête*, and was highly pleased with the courteousness and kindness of their manners to each other; the general propriety of their behaviour forming a striking contrast to the rudeness, boisterous violence, and drunkenness, which would have been exhibited by the same number of manufacturers in Lancashire, assembled on a holiday. — *B.*

* A hectare of land is equal to somewhat more than $2\frac{1}{4}$ acres English statute measure.

been omitted or neglected, and the supplies for the establishment were drawn from two gardens in the valley near the dwelling of the proprietress. Adjoining the garden is what is termed the park, which consists of a considerable tract of land with alleys planted in the formal French style, some of them very wide, and others double, with rows of trees between. A great part of this land has not been yet reclaimed; whilst other parts are under cultivation, and mostly preparing for *sarrasin* [buckwheat], after potatoes or lentils. The elevated site of this spot, and the abundance of shade which must in a few years result from the growth of the trees, will render it, in spite of the neglect and want of taste conspicuous therein, a great acquisition, and source of pleasant exercise in the season, to the visiters of the baths, especially when the stones of which the roads are made, are broken small or well covered with gravel. The accommodation for visiters at the baths is extensive; and the sleeping apartments, in the new and largest part, excellent. We were assured that at times in the season there had been 100 bathers in a day. There are two series of baths, one for gentlemen and the other for ladies, with each its dressing recess, under the same roof; and across the yard is a large bath through which a strong stream of warm water is always running, with pipes for *douches*, &c., capable of accommodating many persons at one time. The natural temperature of the water is about 50° Fahrenheit; but the private baths may be had of any warmth desired, by means of artificial heat. The Forest of Ardennes is the most considerable in the north-west part of France; its extent could not be ascertained when we were there, as it had never been measured, surveyors for that purpose being expected daily. Under the general head of this name, it is subdivided into very extensive portions, each of which has its appropriate and subordinate name, as the "Forêt de la Ferté Macé," &c. From traversing it in various directions, and from the best information we could obtain of resident officers of the forest and other persons, it must comprise in the whole many thousand hectares of land: it is national property, and, like all the rest of the national forests in France, is at present wretchedly managed. The outskirts of this forest, to the extent of six or eight thousand English acres, were like several other of the national forests, to be sold; and in all probability at prices which would well repay a judicious and capitalised speculator. The timber consists chiefly of beech, oak, and ash; the underwood of all these, with the alder, willow, birch, &c. In or near the centre of the forest, and on high ground, is a large circular space cleared of trees, from which diverge eleven spacious avenues or alleys, each of which leads to some town or village in its immediate neighbourhood. The views from this central point, called *La belle Etoile*, are very striking, and the display of such multitudes of magnificent trees grand and impressive in the extreme. On the northern borders of the forest ores of iron abound, which are fluxed with the charcoal made in the forest. It is doubtless in this part of the country that the chalybeate springs of *Bagnoles* originate, though at a distance of some miles; there is said to be a small portion of sulphur also detected on analysis of the water. The products of the soil, whether in the department of arboriculture or horticulture, much resemble those of the south of England, as do the general features of the country those of some of its richest parts. The seasons also are like those of England; the winters probably severer, but drier; the springs undoubtedly earlier, though not so early as those of *Touraine* and *Poitou*. Meadow grass was being cut between *Bagnoles* and *Couterne* on the 28th of May, when we left the wells.

The cottage and farm gardens in the neighbourhood of *Bagnoles* have nothing to distinguish them from the general run of such gardens in France, certainly not much to eulogise; but then, the greater number of occupiers of land are proprietors also, and draw a great part of their vegetables,

and, indeed, of their subsistence, from the produce of their little fields ; most of which have in them a full proportion of apple trees. Of the sarsin, the most favourite object of cultivation, is made a great proportion of their bread ; and, besides the potato, they have many sorts of the *Brásica* tribe, and haricots and other lentils in abundance. For the domestic employ of the women, as well as for sale on a large scale, much flax and some hemp are sown ; both of which, in the month of May, promised abundant crops. This department has a large population, but it is not strikingly visible. There is very little of distress apparent amongst the lower classes, though it was said many young men had been allured to Paris by the offers of employ on the public works ; and the expenses of the government were universally complained of. The fact is, France, like the rest of the world which has been aroused from its state of lethargy, and gotten rid of some of its ruinous and disgraceful ignorance, wants a *cheap government*. This Louis Philip promised them, under the term “republican institutions,” when he was elevated to the throne in consequence of the revolution of July, 1830. This promise, however, he has never fulfilled ; and France is consequently dissatisfied, and Louis Philip’s throne unstable. — *John H. Moggridge. Woodfield, Nov., 1831.*

New Method of training Hops in the Vosges. — M. Denis, member of the Society of Agriculture of the Vosges, has published a treatise on the cultivation of hops ; in which he recommends, from experience, the substitution of iron wires for poles, for the training of the plant. These wires, formed in pieces of about 3 ft. in length, and joined together, so as to resemble a surveyor’s chain, are suspended horizontally between two oak posts, placed at the extremities of the lines of hops, and supported by wooden props at regular intervals. The hops are conducted by little rods to the iron chain, along which they are trained. M. Denis computes that, by his practice, about a fifth part of the original cost of poles is saved. (*Bulletin des Sciences Agricoles.*) We saw hops so trained on M. Denis’s farm at Roville in 1828. The crop had been good, but it did not appear to us any thing like the crops usually seen in England ; nor do we think this mode of training at all calculated to produce an equal quantity of surface with the mode by perpendicular poles. We would rather recommend a congeries of perpendicular wires from one pole. (*fig. 27.*) — *Cond.*

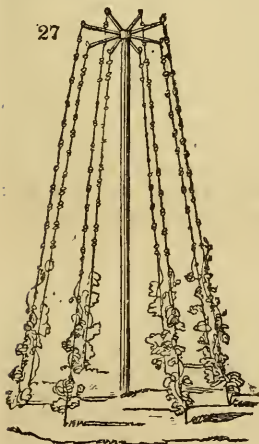

Paris, Dec. 20. 1831. — Our markets have been better supplied with both vegetables and fruit than I have known them for many years. The flowers have been also abundant. A few days ago, I saw in the *Marché aux Fleurs* the finest oleanders in bloom ; a thing not common at this season ; and various species of *Amarýllis*, which, I was told, had not been forced. Many trees have ripened their seeds ; such as the *Andra tríloba L.* [*Asímina tríloba Dunal*] and *Diospýros virginiana*, in Cels’s nursery ; and, what is more remarkable, *Magnòlia macrophýlla*, in the grounds of M. Soulange Bodin, at Fromont. This establishment is in a very flourishing state, and it is quite astonishing to see the numbers of rare or showy green-house plants (such as *Azàlea índica*, *Cunninghàmia*, *Araucària*, &c.) which are raised there from cuttings of the tender points of the shoots, or by herbaceous grafting of the same parts of the plants. As to camellias and oranges, they are raised in quantities beyond number ; *Caméllia mutábilis*, a seedling from the same double red as was raised in the Traversi Gar-

den at Desio, near Milan, by M. Jean Casoretti, in 1824, flowered with M. Soulange Bodin at Fromont, last spring, for the first time in France. But this, and other news of the kind, you will find in the *Annales de Fromont*; of which M. Soulange Bodin informs me he sends you regularly a copy. Some curious discussions have lately been going on in the Academy of Sciences on the subject of vegetable physiology, which, I trust, will attract the attention of Mr. Lindley, as his doctrine (originated by De la Hire, and continued by Darwin, Du Thouars, and Poiteau), of every bud which produces a shoot sending down roots under the bark, &c., is opposed, and, as it is thought, proved to be false, by a committee of the Academy. I am sorry to say, that, notwithstanding the abundant crops, there is a great deal of distress at present prevailing in this country, not only among the manufacturing, but among the agricultural, class. The causes are various; but the chief I believe to be discontent at the excessive amount of taxes, and especially at the income of the king, which is enormous; being, as a clever writer in one of the newspapers states, about 20 francs (16s. 8d. sterling) every minute; or, as much in ten minutes as a Lyons weaver gets in a year. — *T. E.*

The Subscription Garden at Lisieux in Normandy. — The subscription garden at this place is very extensive, containing numerous shady walks, fine trees, beautiful shrubs and flowers, a variety of rural seats and alcoves, a retreat in the midst for meditation, and fishponds with gold and silver fish. At the entrance is a lawn, of an oblong form, the ground rising to the right, and in front. I think there are twenty-four subscribers. The people of Lisieux appear very fond of cultivating gardens; many of which contain choice and rare specimens of shrubs and flowers. Among other shrubs, that called Barbe de Chèvre (*Spiræa Arúneus*) is much admired. A. M. Quesncy has a very pretty garden, laid out with grottos, arbours, &c., and a room elegantly fitted up with yellow damask curtains, mirrors, sofa, an ornamented chimney-piece, an organ, books, chairs, &c. The walls are painted by himself, and represent scenes in Rome and Athens. I saw in this garden a great variety of flowers; particularly aloes and roses: among the latter were a dozen sorts of roses upon one stem. — *J. M.* June 10. 1831.

GERMANY.

Vienna. — *The Tivoli Garden at Vienna* (fig. 28.) was first opened in the spring of 1830. It is one of those public places of amusement which, within these few years, are become fashionable in some of the large towns on the Continent, as Paris, Naples, Milan, &c. It is situated on the east side of the garden of Schönbrunn, on an eminence called the Grüenberg (Green Mountain), about two English miles from town, and in the fine evenings of summer is frequented by the most respectable society. The building is sufficiently spacious to contain from two to three thousand persons; and its appearance, as well as the internal arrangements, is particularly striking and elegant. In the centre is a large saloon, with billiard tables, and at each end are various rooms for refreshments. The principal amusement of the place is riding on little carriages, each containing two persons, which are set off from an elevation of about 12 ft. at the one end of the building, and by their own weight are propelled along a descending undulated railway, which passes in an extended circle to the other extremity, where the people alight, and either ascend the steps in the front to the refreshment rooms, or walk in the gardens. The carriages are then drawn under the building up to the place from whence they set off, ready for a new course. The thunder-like noise occasioned by their continual passing along the wooden railway is agreeably softened by two bands of music, which play alternately. Those persons who do not choose to ride

may enjoy the scene from a broad terrace which is over the colonnade, and which affords a fine view, not only of the garden, but also of the surrounding country. On the other side of the building are winding walks, in the manner of a labyrinth, and the endeavours of some to extricate themselves

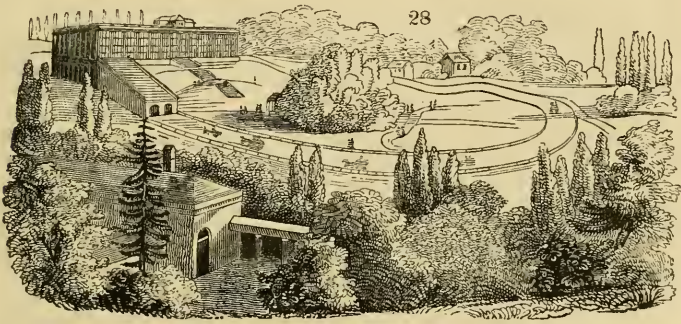

afford much amusement to the spectators from the terrace. In the evening the whole place is brilliantly illuminated with various coloured lights, which have a most pleasing effect, and occasionally the amusements of the day are terminated with a display of fireworks. — *C. R.* Dec. 1831.

Munich. — Some forcing-houses in the royal kitchen-gardens at Munich have been heated by hot water, on the level circulation principle, from the plan of the chief garden inspector, M. Sckell, who has published a plan of the houses heated, and of his apparatus, in a quarto pamphlet, now before us. He notices the mode of heating by the common German stove, to be seen in every inn and post-house north of the Rhine; by flues, as in hot-houses in England; by steam, which has been treated of by Seidl, Otto, and Schram, in the *Berlin Horticultural Transactions* for 1827; and, lastly, by hot water. He gives the history of this mode from facts which it is impossible he can have obtained any where else than from the *Gardener's Magazine*, which we regularly send him in exchange for certain Munich publications; and yet he has not once mentioned that publication, or referred to any source from which he obtained his facts. We do not state this in the spirit of finding fault; because, as far at least as gardening and agriculture are concerned, it seems to be the general practice of the German authors, and indeed of those of the Continent generally. Hence it is that articles and curious facts which have been stated for the first time in an English publication, are not unfrequently translated into some Continental publication, and again translated into English, and published as novelties, in some of our journals, with the name of the foreign paper appended as an authority. Almost every *Literary Gazette* and *New Monthly Magazine* contains paragraphs of this description, not a few of which are from the *Gardener's Magazine*. We may instance the article in our first Number, on washing salads in salt water, which was unnoticed by any paper in England, as far as we observed, till it was retranslated from the French; after which, having appeared in the *Literary Gazette*, it made the tour of Europe and America. One of the latest *Literary Gazettes* which we have seen contains "Growing potatoes in a cellar, from a German paper," a mode which appeared several years since in our *Encyclopædia of Gardening*, 2d edit. p. 594, 595. The same article was inserted in the *Bulletin des Sciences Agricoles* some months ago, and also in *Moleon's Recueil Industriel*. We find no fault with any of the parties; we merely state the facts, to account

to some of our readers for our not inserting *all* the scraps of this sort which they are good enough to copy out and send us from journals and periodicals. — *Cond.*

ITALY.

The Olive may be propagated not only by Novoli (see Vol. VII. p. 663.), but more expeditiously by Buds, Cuttings, and Grafts. — The cuttings are the most valuable, as they soonest produce fruit. They take root so readily, that sometimes a branch or even a trunk of an olive tree that has been broken off, if put into the earth to serve as a prop for a vine or any other tree, will grow, and, in three or four years, bear a tolerable crop of fruit. The best mode of propagation, however, is that adopted by the olive-growers in Tuscany, viz. to raise plants from seed; a method which invariably produces the largest, strongest, and best young trees.

In several parts of your Gardener's Magazine, you have expressed an opinion that there is no essential difference between plants raised from seed and those propagated by cuttings or shoots. The result of some observations I have made upon the growth of the olive tree seems to contradict this opinion.

An olive tree raised from seed throws out a leading or tap root, which penetrates deeply into the ground, while its stem ascends in a vertical direction. An olive tree propagated by cuttings or shoots has no leading root; but its other roots, springing only from the circumference of the section of the cuttings, eye, or shoot*, spread out near the surface, without ever striking deeply into the soil. This fact is so well known, that on the sides of the hill of Lario, where for ages past the olive tree has been cultivated, the peasants have a common proverb, "That the roots of the olive tree love to hear the sound of the bells." Hence arises a phenomenon which many of your worthy countrymen who have travelled near the Lake of Como may have observed, which is, that the olive trees that are planted upon the sides of those mountains, although originally placed in a vertical position, incline, by degrees, towards the horizon, until they become perpendicular to the side of the mountain; or, in other words, until they have acquired the same degree of inclination to the horizon as the declivity itself has. That such should be the case appears perfectly natural: since the roots of an olive tree raised from a cutting or shoot, growing very wide apart and always close to the surface of the soil, form a level parallel to its slope. According to this direction of the roots, the stem or trunk of the tree is forced to take one which may not lean upon any portion of the roots more than upon another; it must therefore be perpendicular to all, thence perpendicular to the sides of the hill. This inclination of the olive tree may appear, at first sight, to be extremely useful to the economical disposition of the ground, because, upon ground which inclines towards the horizon, the more the trees upon it follow the direction of the slope, the greater will be the number of plants which the space can contain; the number of trees planted vertically being to the number of those whose position is perpendicular to the slope of the hill as the cosine of the angle of inclination is to the radius.

Nevertheless, this inclination of the olive tree is in truth one of the causes which conduce to its decay, as I have shown in a paper inserted in the *Annali Universali di Agricoltura*, vol. viii., entitled "On the Decay of the Olive Trees which grow upon the Hill bordering the Lake of Como, the Appearance of the *Musca oleæ*, &c" This diversity of direction might

* Not a single root can spring from the central and inferior portion of the section, where there is no liber, from which alone roots can be produced.

by itself show that there exists some difference between seedling plants and those of the same species raised from cuttings or shoots. Further, a seedling olive tree never puts forth any suckers; it flourishes upon the edges of mounds, upon rocks, and even upon the bare calcareous sandstone, because its roots, penetrating amongst the crevices of the rocks, meet with nourishment to insure a vigorous vegetation; on the other hand, an olive tree raised from cuttings or shoots throws out from its roots a numerous progeny of suckers, which weaken the parent tree, and very often expose it to suffer from aridity, even when planted in a deep soil.

There is also a difference with regard to the development of the vital power, or mode of vegetation, between trees raised from seed and those propagated by cuttings. I have selected the olive as an example, because I have it close at hand; but I have no doubt that the same doctrine would hold good with respect to other trees, and in England as well as Italy.

Mr. Sweet, in his *Botanical Cultivator*, first edition, affirms that "seedlings are not so hardy, nor so easily preserved, as plants raised from cuttings, and seldom make such good plants." A little afterwards, he adds:—"Plants raised from cuttings taken from flowering plants will flower quite young, which cannot be expected from a seedling." But mark how I shall return the argument: if they flower while yet quite young, it must make them small and weak, because (you have yourself referred to this in Vol. V.) the calling of the generative faculty precociously into action has a tendency to enfeeble the plant, and to prevent the due development of its physical force: the plants, consequently, become weak; and, being unable to resist the bad effects of the external action of the atmosphere, are more exposed to disease, and, of course, more likely to die. A stalk of oats or of mignonette may live four years, if the flower-stems are cut off as they appear. Your gardeners are aware that it is necessary to prevent the too early flowering and fructification of fruit trees, particularly peach trees, otherwise they are weakened, remain dwarfish, and perish young. The same thing happens to animals: a male and female silkworm (*Phalæna mōri*), allowed to copulate, die in thirty-six hours; if kept apart, or the act of generation prevented, the two silkworms would live six days: although provided with organs, they never eat.

I heard, some time since, that you wished to receive accounts relating to the science of horticulture in Italy. If you should think that I can be of any service to you in this matter, I shall be most happy to be placed on the list of your contributors, and I will send you, by the first opportunity an account of a very beautiful variety of the *Pelargonium cordatum*, with double flowers, lately obtained from seed by Sig. Giuseppe Manetti, in the imperial and royal gardens near Monza. Other accounts shall also be communicated to you upon the success obtained in the cultivation of the *Nelumbium flavum* and *N. speciosum*, in the open air, in the north of Italy; and of the naturalisation of the *Agave americana* on the rocks near the Lake of Como, where it grows spontaneously, and produces fruit within less than sixteen years. I will inform you, in short, of the present state of horticulture in Lombardy, and the immense improvements which it is capable of receiving in different parts of this kingdom. The progress in horticulture, to which your works have so greatly contributed, had encouraged me to undertake the publication of a journal, on the plan of your truly excellent *Gardener's Magazine*, which I should have called *Giornale dei Giardinieri e Registro degli Novanzamenti in Agricoltura* (The *Gardener's Journal and Register of Agricultural Improvements*). But, occupied in employment wholly foreign from any kind of literature, I have been obliged to postpone this undertaking. In the mean time, I have thought it useful to begin publishing a translation of your highly valuable *Encyclopædia of Gardening* and *Encyclopædia of Plants*; because, when any improvements are to be effected in any art or science, it is requisite

that the present state of that art or science should be previously ascertained, in order to make known the most effectual means of improvement. Nor would it be deemed probable, for instance, that the marshes of Colico, the Lakes of Canzo, of Pusiano, and of Oggiorno, all in Lombardy, could be rendered healthy and useful, besides being embellished by the introduction of the *Schubertia disticha*, the *Cupressus thyoides*, the *Nýssa aquática*, and of the different kinds of nelumbiums, unless an authentic account should first be given of what they are; of the nature and properties of the deciduous cypress, the white cedar, the tupelo, the yellow nelumbium, and the *N. speciosum*. Nor could it be hoped that the cultivation of the pine-apple in the open air (*l'ananasso all' aria aperta*), on the sides of the Lario Hills, would be attempted, without a previous knowledge of the nature of the soil, the degree of temperature, and the methods which are required for the growth of this plant. I am, Sir, yours, &c. — *Luigi Manetti. In the Office of the Imperial and Royal Gardens of Monza, Lombardy, Sept. 8. 1830.*

Olive Trees from Seeds or from Cuttings essentially the same (extracted from the Conductor's answer to Signor Manetti, dated Jan. 12. 1832). — With respect to the propagation of the olive, I allow that what you state is perfectly natural and correct; but I still consider a plant, whether raised from a seed or a cutting, as essentially the same, on the following theory: — If you were to plant one of your olive trees, raised from cuttings, on a tolerably rich soil when young, and a few years afterwards, when the tree had firmly established itself, were to cut it down to the ground; and when it grew the following spring, were to leave only one of the numerous shoots which it would send out from the stool, you would find that this shoot would produce as upright and handsome a tree as a seedling; and that, if the soil and subsoil permitted, it would send down a tap root as strong as that of a seedling, unless it had already a sufficiency of horizontal roots. This theory is perfectly consistent with the fact that a cutting or a layer will, under ordinary treatment, and especially in poor soils, assume the habit of a branch, rather than that of a young tree. I apprehend that you would find, if you were to plant seedling olive trees on the sides of the hill of Lario, that they would assume the same forms as those raised from cuttings. The reason why the trunks of the olive trees on the declivities of Lario are perpendicular to the plane of that declivity, and not to the plane of the horizon, is to be found, in my opinion, in the nature or mode of growth of the tree itself, rather than in the manner in which it is propagated. I recollect seeing very few olive trees in either France or Italy, of any size, that stood perpendicularly, or had heads which could be called well balanced. . . .

NORTH AMERICA.

Parmentier's Garden, near Brooklyn.—Sir, At the request of some of your readers in this country, I have compiled from different authorities, but chiefly from the *American Farmer*, an account of one of the first botanic gardens which has ever been established in this country, viz. that of Parmentier, about two miles from Brooklyn, Long Island. The following map (*fig. 29.*) will serve to convey some idea of the general disposition of the whole; but I am confident that neither plan nor description can furnish any adequate idea of the particular beauties of the place. Its establishment may, indeed, be looked upon as an epoch in the history of American horticulture; as, though the various branches of that science were before understood and practised by most of our gardeners, it had not attained its full perfection until the arrival of M. Parmentier. The elegant villas and country residences of many of our citizens, together with our well-supplied markets and fruit-shops, afford abundant evidence that both the ornamental and useful branches of the art were successfully pursued among us; but the garden of M. Parmentier is, perhaps, the most striking in-



- a*, Dwelling-house.
b, Labourers' dwellings, 2.
c, Tool and work-house, 2.
d, Barn.
e, Green-houses, 2.
f, Hotbeds, 3. *g*, Plan for plants in summer, 2.
h, Herbaceous plant garden. *i*, Rustic arbour.
k, French saloon.
l, Nectarine and peach tree alley.
m, Pear tree alley.
n, Apple tree alley.
o, Plum tree alley.
p, Cherry tree alley.

1. Vines, 10 squares, 263 kinds.
2. Rose trees, 2 squares, 250 kinds.
3. Ornamental trees, 7 squares.
4. Peach trees, 4 squares, 64 kinds.
5. Apple trees, 3 squares, 24 kinds.
6. Plum trees, 2 squares, 85 kinds.
7. Pear trees, 4 squares, 190 kinds.
8. Cherry trees, 2 squares, 71 kinds.
9. Imported fruit trees, 5 squares.
10. Young vines, 5 squares.
11. Quince stocks, 1 square.
12. Monthly strawberries, 1 square.
13. Place for manure and weeds.
14. Jamaica turnpike.
15. Flatbush turnpike.

The other kinds of fruit are : — Nectarines, 15 kinds ; apricots, 18 kinds ; walnuts, chestnuts, filberts, and hazel nuts, each 20 kinds ; quinces, 5 kinds ; raspberries, 5 kinds ; gooseberries, 20 kinds ; currants, 7 kinds ; strawberries, 17 kinds.

stance we have of all the different departments of gardening being combined extensively and with scientific skill. The rapidity with which this garden was formed added to its effect. Nearly twenty-five acres of ground were originally enclosed ; and the inhabitants of the vicinity beheld, with astonishment, in the short space of three years, one of the most stony, rugged, sterile pieces of ground on the whole island, which seemed to bid defiance to the labours of man, stored with the most luxuriant fruit, and blooming with the most beautiful flowers.

The ground-plan of the garden, although without any remarkable inequalities, has yet some diversity of surface. The most elevated part, facing the south and south-west, is appropriated for the purpose of a vineyard ; and several valuable varieties of the grape, foreign as well as indigenous, are there cultivated. The beds of the ornamental part compose broad belts laid out in a serpentine direction, and edged with thrift (*Statice Armèria*). These sections contain a mixture of plants and shrubs of both the Old and the New World. The several species of *Robinia*, the *Philadelphus grandiflorus*, the *Halèsia*, the *Ptèleæ*, and many others conspicuous for their beauty, are interspersed and contrasted with the delicate *Támarix* of Europe ; the paper mulberry, now bearing its curious fruit ; several species of shrubby willows and poplars ; the splendid *Anchúsa capénsis*, with its azure blossoms ; the no less luxuriant *Balsamina* ; and thousands of others

which we might mention, all disposed in the most artful manner, so as to heighten the effect, and yet to conceal too glaring an appearance of art.

In the northern parts of the garden are nurseries, containing young plants of every kind of tree which is to be found in the beds. To the left of the garden, an avenue leads to a rustic arbour, in the grotesque style, constructed of the crooked limbs of trees in their rough state, covered with bark and moss : from the top of this arbour a view of the whole garden and the surrounding scenery is obtained ; including Staten Island, the Bay, Governor's Island, and the city of New York. At some distance from the rustic arbour is a plot of ground, called the French Saloon ; a beautiful oval, skirted with privet (*Ligustrum*), kept dwarf to the height of 1 ft., and enclosing a solid mass of China monthly roses. The various kinds of fruit trees are carefully arranged, and the alleys leading to them are skirted with specimens of the different sorts in a bearing state, for better exhibition, and to furnish the necessary grafts for the establishment.

The green-house department, although not so extensive as some other parts of the garden, contains many beautiful plants, exhibited with the same tasteful arrangement which characterises every part of M. Parmentier's establishment ; and which displays itself even in the grouping of the pots, which are all arranged according to the colour and size of the flowers : thus showing the variety of ways in which a skilful gardener may distribute his materials to produce a picturesque effect.

The manner of protecting the plants in this garden from the violence of the weather or the heat of the sun is quite novel in this part of America ; canvass covers being so managed as to be rolled or unrolled with the greatest ease and despatch, by means of ropes and pulleys. The necessity of some such screen is quite obvious, when plants, and particularly tender exotics, are exposed to our excessive sun, and yet it is too generally neglected among our gardeners.

In short, this establishment is well worthy of notice as one of the few examples in the neighbourhood of New York, of the art of laying out a garden so as to combine the principles of landscape-gardening with the conveniences of the nursery or orchard. — *J. W. S. New York, September, 1829.*

The late André Parmentier and his son having both died within a short time of each other, the widow of the father has determined to sell the property ; and, as will be seen by our advertising sheet, it is now on sale. — *Cond.*

Railroads, we observe, are increasing rapidly in America. There is one in progress between New York and Philadelphia, of about eighty miles ; another between Philadelphia and Columbia, of eighty-one miles ; one between York Town (not far from Columbia) and Baltimore, of upwards of fifty miles. Thus New York, Baltimore, and Philadelphia, three of the most important towns in the United States, are brought within a few hours' distance of each other respectively. The water communication between them has long been complete. Our much esteemed friend and correspondent Mr. R. C. Taylor, engineer at Philipsburg, has projected and circulated proposals for a railroad of thirty miles, from the Pennsylvania canal to the bituminous coal district of Philipsburg ; the promised advantages of which are so great, that we have little doubt but it will be carried into execution.

We observe, by the speech of President Jackson, delivered to Congress on Dec. 6., and printed in this day's (Dec. 30.) *Morning Chronicle*, that the debt of the United States will be paid off in a year ; and that, consequently, there will afterwards be no employment for the income of that immense country but in public improvements. We wish we could impress on Congress, and on the admirable person who now fills the chair of Washington, the great advantages that would result from preventing any roads being made in the United States of a greater slope than half an inch in a yard. We have elsewhere (Vol. VII. p. 520., and *Morning Chronicle*,

Dec. 31. 1831) hinted at some of the principal of these advantages; and we entreat some of our American readers to call the attention of the American legislature to a subject of so much interest to a road and canal making nation. — *Contd.*

Philipsburg, Centre County, Pennsylvania, United States, Aug. 7. 1831. — Sir, . . . Placed, as I am, so remote from libraries, and from access to European periodical works, such publications as yours are more interesting to me now than ever. I have opened your *Encyclopædias*, with much interest, at the passages relating to North America, and can bear testimony to the general accuracy of your authorities. I am happy to report that the climate has agreed perfectly well with myself and family, and we have now run nearly the entire circle of the seasons. Not the slightest illness, not even a cold, has occurred, if I remember right, to any one of us since our arrival.

Our position here, near the base of the western slope of the Alleghany mountain range, is one of the healthiest in the United States. The past season has been delightful in temperature; the thermometer averaging probably about 70° in the day, and the nights have been cool and refreshing. We possess here an advantage somewhat remarkable, but which we prize highly: at about nine or ten o'clock every morning, a refreshing breeze springs up, and continues until three or four in the afternoon; and it is this, perhaps, which makes our situation so healthy, and enables us, without inconvenience, to bear the warmest days of summer. These delightful breezes appear to proceed from the north or north-west, and remind us of the sea breezes upon the never to be forgotten shores of dear old England.

I shall not attempt, my dear Sir, to give you a lengthened description of the place which is likely to be the residence of myself and family for some years, at least, if we live. My brother has, probably, had opportunities of informing you generally on that point. I can now speak, from professional observation, that we are situated about 1350 ft. above the sea, and about 800 to 1000 ft. below the main ridge or crest of the Alleghany Mountains. There is one depression, or gap, as it is called, ten miles hence, which I have found, by levelling, to be only 600 ft. above us; and which 600 ft. are distributed pretty gradually along the above base of ten miles. Consequently, you will observe that it is possible to descend the Alleghanies, westward, at a very small angle; not much more, indeed, than half a degree, which is not a very alarming inclination, even for a railroad. The eastern descent is more rapid; perhaps at three degrees for the first three miles, following the natural fall of the water-courses. I cannot but consider that our climate is materially influenced by our proximity to this vast mountain ridge, which is 1200 miles in length. I find very little variation in the barometer from 29 in. A fall always precedes wind from the north-west. We never suffer much from the extreme heat of summer, nor are we materially colder in winter than is observed in the cities on the Atlantic coasts. One of my friends here kept an accurate meteorological journal during many years, and I brought out with me two of Jones's best mountain barometers, which I amuse myself by frequently referring to. Our prevailing winds are from the north-west; which winds certainly bring a vast quantity of rain. The present summer has been more wet than has occurred in the memory of man. Rain has fallen, on an average, I should think, every alternate day; yet the evaporation is so great, that but little inconvenience has arisen, except of late, when steady dry weather is needed for the hay and corn harvests, which occur at the same time. The farmers in the corn districts are beginning to complain of the damage done to their crops by the continued rains; and serious injury has been sustained from floods. This unusually moist state of the atmosphere has kept the air and the surface of the earth unusually cool. We have had but one week of really hot weather, and then not more than I have felt in England for much longer

periods ; particularly for nearly three months in 1826. To-day (Aug. 8.) the thermometer has not reached above 64° in the room in which I am now writing, and in the air it is below 60°, and we light our fires, being too cold to sit with our windows open ; but this, I hope, will not continue. The nights are excessively cold, and the dews are heavy. I am assured that this is a very remarkable year ; the winter was more severe than had occurred for thirty years preceding.

When I entered my present dwelling-house last fall (October), I found a plot of ground of 40 or 50 perches, intended for a garden, but uncultivated, and only occupied by enormous thistles and docks, and abundance of wild sorrel. These it was my first business to destroy, by collecting them in a pile, and making a bonfire. There were many pine and hemlock stumps also sprinkled about, and which prevented any regular operations of culture. These, also, I, with great labour, got rid of, for the most part. One sturdy stump kept me at work three days before I conquered him ; for he seemed to bid defiance to the axe and the fire, although the tree had been cut down thirty years before. I was a young beginner then, you will observe, in stump-moving ; and, besides, I prided myself in the design of bringing this little plot into a good state without the aid of any body, and without its costing me a cent for labour. Now and then my American neighbours would peep over the rails to see me digging and chopping, and would guess I was not used much to handling an axe. However, by perseverance, I got them all out, and rolled them clean off the premises, and there they all lie around me, monuments of my first year's labour. These same stumps, by the way, are so full of turpentine, and are so hard and tough, that they seem to defy the power of time and the elements to decompose them : at all events, they have been known to continue firm and sound above a century. Having cleared off the surface weeds, I ploughed up the soil, having first spread upon it a thick covering of manure (a thing not used or valued much in this country, from the expense of carrying it on the land), and by this time the frosts began to set in, and I let it remain undisturbed till the frost broke up in March. As there was neither tree nor shrub for shelter or ornament around my house, and as the garden was much exposed to the heat of summer and the cold northern blasts of winter, I set to work to procure young trees from the woods ; amusing myself with selecting specimens of every variety, within my reach, that the neighbouring forests produce. You well know, my dear Sir, what a beautiful and rich series the American forests furnish. My industry was rewarded by a very interesting collection, serving the double purpose of a screen or shade, and of an embellishment. This moist season has been much in their favour, and they flourish well, and remind me of our English ornamental shrubberies. In this part of my labour, I must confess, I did not receive much encouragement. My neighbours viewed it quite as an act of supererogation : that an Englishman should take the trouble to come and plant trees, when all other men employed themselves to cut down, was beyond all comprehension ; was out of all custom and precedent, among a race whose habits and associations lead them to view as the greatest of natural beauties a naked "clearing," surrounded by a "worn fence" of split rails. About the 8th of March, the snow disappeared ; we once more saw the grass upon our "Beaver Dam meadows," and the ice broke up from the Moshannon creek at the bottom of my garden. In the woods, the snow lingered until the 1st of April : but at the earliest moment that I could make any impression upon the ground, I commenced my spring operations in the garden. You will smile at my narrative ; but I was determined to supply my family wholly with vegetables of my own raising, and I have the gratification now of seeing it effected, and producing enough, too, for the whole winter, I think. I first cut out my walks, and subdivided the ground into squares, then dug, and trenched, and cleared, and weeded, and took out every stone ; made a map of my land, and arranged my crops and courses, like other great farmers, in the

“old country.” I had to send 240 miles for my first year’s stock of seeds, but I shall now have a good supply for future wants, and enough of the useful products, such as potatoes, beet, parsneps, carrots, beans, celery, cabbages, &c., for winter stock; all which will require some management to preserve from our intense frosts. The radishes here grown are as large almost as Swedish turnips, and, I think, are not so good as the kinds we used to buy at Covent Garden Market. The lettuces, also, are very inferior to those produced by your Bayswater neighbours. Of potatoes I have four sorts, of peas four kinds, and of beans three sorts. I have planted one bed of asparagus from young plants, and a bed of strawberries, besides borders of the indigenous strawberry, which grows in the meadows, and which is of fine flavour, and would improve much by cultivation. So great is the profusion of these strawberries, in certain spots, that one meadow of six acres, that I saw nineteen miles hence, in June, the owner told me, had furnished more than twenty bushels to his neighbours, besides his own family consumption. The wild raspberry has furnished my wife with her stock for preserves; the huckleberry (*Vaccinium*) of our mountains, also, is a wholesome agreeable fruit for tarts and preserves, as is a small wild cherry (the crab cherry), which is now ripe, in vast abundance, in our low woods. Cranberries (*Oxycoccus macrocarpus*) also occur, and the blackberry (*Rubus*) is particularly fine, and well worth preserving for family purposes.

I must not omit mentioning my little patch of corn or maize. This, being planted in rather a new soil, has thriven wonderfully; the plants being now 9 ft. high. I planted them in rows, 6 ft. apart, and by threes, . . . 3 ft. or 4 ft., asunder, in the row. This enables me to weed and stir the ground at intervals; and, not to lose room, I have transplanted a row of parsneps between each. The arrival of your *Encyclopædia of Agriculture* enables me to refer with pleasure to the notice of planting maize, which you have faithfully given. I cannot state what sort mine is; but it is very fine, and brought out of Kentucky by a friend. We are just beginning to eat the young ears green. You have noticed, I dare say, the singular appendages which occur at the bottom joints of this plant. Cobbett, in your quotation, calls them roots; but a slight observation shows that they do not perform such an office. I should rather call them props or crutches. They seldom appear whilst the corn is upright and uninjured; but the moment a plant is shaken down or partly blown on its side, these offsets protrude in the required direction, and support the stem firmly, till it regains its original vertical position, and this, too, in a remarkably short space of time. I have some singular instances of this in my garden.

I have now detailed to you my principal gardening operations, and I need scarcely add, that, with the necessary allowance for difference of climate and other circumstances, I have worked on the authority, in all cases, of your *Encyclopædia of Gardening*. I might have added that a few apple and peach trees, and plenty of currant trees, I put in last autumn, promise well. There is a vast variety of apples in Pennsylvania, as they are chiefly reared from the seed, without grafting, particularly on the ordinary farms in our district. Occasionally one meets with very fine kinds, whose names and quality are familiar to you. Hops are very fine and luxuriant. I do not know if they are indigenous; but they climb up and surround our buildings in a beautiful style. Our woods produce two or three kinds of grape vine; in particular the fox grape (*Vitis vulpina*), and the chicken grape. Both of these are capable of being made into wine as good as the best Rhenish. I have transplanted a couple of plants into my garden, for the sake of their shade. In a newly settled country like this, gardening, of course, is only a minor consideration, and is much neglected. It is chiefly amongst the Dutch and German settlers that vegetables are cultivated; and the overplus beyond their family wants is

occasionally offered for sale. I ought to mention that an English gentleman, our principal proprietor here, possesses a garden equal to those attached to most seats in England, and as well attended to. Of the melon tribe, and similar plants, he rears an immense quantity for himself and friends, commencing in frames, as upon the English method, to guard against the later spring frosts.

From my preceding letters you have no doubt derived some information as to the geological position of this district. We are just within the verge of what is probably by far the most extensive coal formation in the world; the qualities of which coal are as yet scarcely known on the eastern coast and in the great cities. It is highly bituminous; more so, I conceive, from the experiments I have tried, than even the Northumberland coal; certainly much more so than the best Welsh coal. From it I have produced tar and coke of superior quality. Neither of these manufactured substances are known to the Americans. The tar of this country is produced from wood, like the Swedish, and the small quantity of coal tar consumed is imported from England, at a very high price. These circumstances, and the demand for similar articles hereabouts, have encouraged me to commence the manufactory of them; and I have purchased a convenient site for the undertaking, half a mile from my residence, and adjoining our turnpike road to Erie. The vein I am now working is $4\frac{1}{2}$ ft. thick, of suitable quality for my purpose, and of itself will furnish a large extra-supply for sale. I have traced at least four or five other veins also in the same locality, which will yield me more than I can require or raise for the rest of my life. There is, beneath the coal, an extensive bed of fire clay, adapted to make the best quality of fire bricks, such as are now imported into the principal American sea-ports, from England, and sold wholesale at 32 to 35 dollars per thousand. I hope at last that I shall bring my geological propensities to account; that they have been useful to me in the choice of this spot I at any rate have some satisfaction in believing. I turned to your *Encyclopædia of Agriculture*, to find something about coal, coke, and coal tar, and the apparatus requisite: but little is introduced on these points on the first, and nothing on the others; probably because you considered the subjects rather too remote from the other improvements of landed property, and not altogether belonging to an agricultural work. The great receptacle for iron ore, and the site of its conversion into pig-iron, is immediately east from this, a few miles over the Alleghany ridge. Thence it is brought hither and to various forges, to be converted into bars or manufactured into various forms, or conveyed 150 miles farther west, as far as Pittsburg, increasing in value at every mile. The ore is of the hæmatitic kind, very rich, and the iron it yields is equal to the best Swedish. Charcoal alone is employed in its production and conversion. The quantity of wood consumed in converting a ton of iron is prodigious, and occasions a great destruction and consumption of timber: so much is this already felt, that even in this region of forests we hear and wonder about wood for charcoal becoming scarce and expensive in the neighbourhood of all the great iron-works. Sooner or later the English method of employing coke from coal must be adopted, which will then occasion a material reduction in the cost of producing iron, and consequently effect another great advantage, by encouraging the native manufactures of the United States. We have at this village an extensive manufactory of screws, which far excel in workmanship any I ever saw in England. Of course those who are interested in American manufactures are anxious for all the protection against foreign competition and importation that our government can enforce. The tariff regulations have afforded a vast field for political discussions and disputes, which will perhaps terminate in the separation from the Union of one or two of the Southern States. Under all circumstances, I am decidedly of opinion that the true American policy is just that which she has been

forced to adopt. She is called upon to encourage her own internal trade, to stimulate her native industry, to promote public improvements, to rear up, under her patronage, an increasing community of enterprising manufacturers, and to bring into exercise and usefulness the unbounded natural resources of this vast country; thus making herself in practice, as she is in theory and politics, independent of the rest of the world. But I must draw to a termination. . . . I remain, Sir, yours, &c. — *R. C. Taylor*.

New York, October 6. 1831. — Sir, I dare say the few Alleghany acorns which I enclose are of very small value in your opinion; yet as they grew upon a little estate which I now call my own, perhaps you may not think the worse of them, as coming from an absent friend. The small acorns are those of the white oak; the best of the tribe in the United States. The largest are from the red oak; not so good in the quality of its timber, and far less durable. There is also the black oak. With these are some haws from our common whitethorns [these seem to be of *Cratægus coccinea L.*]; also some cones from the red or pitch pine [these are of the *Pinus pungens Lamb.*; specimens of the beautiful cones, and plants, of this species are rare in England], and the white pine of the Alleghanies [these are of *Pinus Stròbus*]. I would have collected others more worthy your acceptance, but my time was too short to enable me to search. I have, with Mrs. Taylor, taken a journey altogether of 700 miles, at twenty-four hours' notice. . . . In haste. Yours, &c. — *R. C. Taylor*.

We have received the packet of seeds safe, and have shared them as follows : — In England, to Mr. Brooks of Flitwick and Mr. Donald of Woking; in Scotland, to the Rev. Mr. Carruthers of Dalbeattie, Sir William Jardine of Jardine Hall, and Mr. Gorrie of Annat Gardens; in Wales, to Cymro at Brecon; and, in Ireland, to Dr. Drummond of Belfast. — *Cond.*

AUSTRALIA.

Van Diemen's Land. — We are indebted to some kind friend in Hobart Town for the *Hobart Town Courier*, which has been regularly sent us for some years. It is a newspaper which, for variety of subjects, orderly arrangement, accurate (and, when required, even elegant or eloquent) composition, printing, and paper, equals any, and surpasses most, of our provincial journals. The editor is evidently a man of far more general knowledge (particularly of natural history and of country matters) than is usually found in the editors of provincial papers in England; and he brings that knowledge to bear in an earnest and effective manner on every subject which comes before him.

On looking over the last packet sent us, containing the news up to the end of June last, the chief thing that strikes us is the increasing prosperity of the country, which is readily judged of by the number and kind of advertisements, the formation of roads, establishment of stage coaches, &c. As the great majority of the settlers are Scotch, one of our countrymen going there would find himself at home at once. A gardener, and also a clever builder, who could act as architect and surveyor, we are sure would do well. Designs for cottages and small villas, we are told, are much wanted; and we have seventy already engraved, and as many more drawn and in progress, with a view chiefly to Australia and America.

Respecting the products of the country, we find in a paper dated May 28., that the gum kino, a hitherto neglected item, is now being gathered from trees in abundance for the London market, as well as some other native gums. It appears that Dr. Murdoch and the editor of the *Hobart Town Courier* pointed out the value of these gums five years ago, and have since been calling attention to them from time to time. It must be highly gratifying to these gentlemen to find that they have at last succeeded.

The Gum Kino is an excellent tan, much superior to the best extract of wattle or other bark, and might be very profitably used as such, independ-

ently of its great use in medicine. It may also be used as good and durable ink. As to the gum arabic, it is that which flows so abundantly from all the species of acacia or wattle trees in the island. It is about one half the value of the other, but is used by manufacturers in vast quantities, as well as in medicine. Dr. Murdoch of Risdon has this year manufactured, from the produce of his garden there, a considerable quantity of excellent oil of lavender; a profitable article of produce, which we are glad to hear that gentleman intends to cultivate largely for export to London, where it is of considerable value. (*Hobart Town Courier*, June 4. 1831.)

The Fruit of Feuillea cordifolia [a plant which we could wish were introduced to Britain], Mr. E. Drapiez has ascertained, by numerous experiments, is a powerful antidote against vegetable poisons. He poisoned dogs with the *Rhus Toxicodendron* (swamp sumach), hemlock, and nuxvomica. All those that were left to the poisons died, but those to which the *Feuillea* was administered recovered completely, after a short illness. (*Ibid.*, May 28. 1831.)

Roads, we observe, are advertised as open to the public in different directions. We hope that in laying out the lines of these roads, the most scientific views of the subject of road-making have been acted upon. We would direct the attention of those concerned, and more particularly that of the editor of the *Hobart Town Courier*, to what we have said on the subject in our preceding volume (Vol. VII. p. 520.), as also to what will be found in this and our succeeding Number. (See, further, a letter on the subject in the *Morning Chronicle* of December 31. 1831.)

With respect to Emigration, the editor observes that from the experience of a long residence in a populous part of England, previous to his settling in Australia, he can state that paupers, who have become so in the mother country from indolence and an indisposition to work, will continue so in the colony; but that industrious men will speedily, by the fruits of their labour, remunerate the expense that may have attended their passage. (*Ibid.*, June 18. 1831.)

The Swan River Settlement, from all the accounts we have seen, appears to be a failure. "Settlers are in general leaving their first locations, and removing farther into the country; in short, there is no soil until you get near Darling's Range, when some good ground will be found on each bank of the Canning, on which Lieut. Bull grew good wheat, as well as Mr. Wright and Mr. Adams. The crops were very light, Lieut. Bull growing about 5 bushels, Mr. Wright 10 bushels, and Mr. Adams 7 bushels to the acre. The land was certainly very sour, having never been exposed to the sun; and the next season they expect a fair average crop. The expense of clearing, &c., was about 30*l.* the acre. . . . There have, however, been some good vegetables grown even in the sand, with the assistance of manure, especially cabbages, turnips, potatoes, and radishes. There is a radish growing at Perth, in a shoemaker's garden (reserved for seed), as thick as a stout man's thigh, and from 10 ft. to 11 ft. high: in fact, the radish appears to take a different character in the deep and moist sands of Perth. (*Ibid.*, Feb. 5. 1831.)

Sydney. — In looking over the *Sydney Gazettes*, from May 5. to June 28. 1831, inclusive, we do not find much that can interest the gardening world in this country. The improvement of the government demesne or public park and promenade of Sydney, seems to have attracted the attention of government. Mention is made of the skill of the person who has planned the walks, carriage drives, and avenues, which are said to form a delightful place of recreation for the citizens of Sydney. We wish our correspondent, Mr. Thompson, would send us such a sketch and description of this park as he furnished us with of Hyde Park, and his projected improvements in it, for our First Volume.

A writer on the cultivation of *the vine* in Sydney states that blight, after the fruit is set, may be prevented by ringing the old wood which sus-

tains the young branch. He says that the great enemies to the culture of the vine in Australia are, “ the rime, or white frost, which settles on the young shoots in the first stage of their vegetation, and the light mists which shroud the valleys and the sides of the hills before sunrise. When the solar rays reach either of these phenomena, it becomes suddenly dissipated; and the young shoots of the vine and their incipient blossoms are exposed to an instantaneous transition from extreme cold to extreme heat.”

Frost he does not consider so great an enemy to the grape in Australia as the mists, which, during the spring months, hang like a fleecy mantle over the forests, and trail along the vales. He recommends selecting the steep sides of declivities for the sites of vineyards, and, at the same time, burning the forest for a considerable distance on each side of the space intended to be planted with vines. The advice, as far as it regards situation and free exposure, will apply to the planting of orchards in Britain.

The New Zealand flax, which forms an important article of commerce between Sydney and New Zealand, is recommended as a very suitable plant for the moist lands of New Holland. More tobacco, it is stated, will soon be grown than is required for the consumption of the colony.

We observe (*Syd. Gaz.*, June 16.) an advertisement for a gardener, “ an experienced person, qualified to take charge of a small garden.” This is a gratifying mark of prosperity.

ART. IV. Domestic Notices.

ENGLAND.

THE Gardens of the Birmingham Workmen, which you noticed Vol. VII. p. 409., were so numerous twenty years ago, that the late rector, Mr. Curtis, complained to me that they covered 300 acres, and not one of them paid any tithes. He wished me, as the bailiff of the free school, to pay that part of the tithe which belonged to the school, but this I declined. — *W. W. C. Clevedon, near Bristol, November 18. 1831.*

New Botanic Garden at Bury St. Edmunds. — On passing through Bury I called to see the botanic garden, the new one I mean. It is certainly a most eligible spot for the purpose. The architectural remains, in connection with their history and the uses which the buildings originally served, and the great variety of plants with which the garden will shortly be stored, cannot fail to make it very interesting. Mr. Hodson’s new house is in the garden, in a forward state, and is in very good keeping with the remains of the old buildings. Considerable progress has been made in removing the plants from the old garden; much, notwithstanding, remains to be done. Tradesfolk were busy in preparing to put up a cast-iron fence on each side of the magnificent abbey gate, which is to form the main entrance to the garden, and which so highly adorns that fine open area called the Angel Hill. When all is completed I have no doubt the garden will be an ornament to the town, and a credit to Mr. Hodson and the subscribers. — *J. D., senior.*

The Choco Palms. — I hope soon to obtain plants of the famous Chontaduro palm of the Choco, which has never yet been examined by botanists. Humboldt speaks thus of it in his enumeration of palms which he recommends to the attention of future travellers: — “ 3 Chocoenses, nempe, *Chontaduro trunco aculeis horrido, ex fructibus succulentis escam omnibus (præter unam Musam paradisiacam) præstantem largiens.*” * Mr.

* “ Trunk spinose; fruit succulent, and preferable to all succulent fruits, except that of the *Musa paradisiaca.*”

Watts in his last letter, dated Carthageua, May 1. 1830, says, "I have five healthy plants of the Chontaduro palm, which, if they continue to thrive, I intend sending you by the next packet." I have not since heard from Mr. Watts; but, should the plants arrive in good condition, I have promised one to my old friends, Messrs. Loddiges, for their magnificent collection; the other four are also engaged. The remaining two palms of Choco, noticed by Humboldt, are:—"Palma di mil pesos, oleifera; et Tapara, nana, vix 2—3 pedalis, fructibus trilocularibus magnitudine cocoës, albumine eduli."* This last, as being particularly well suited by its dwarf size to our stoves, as well as being nondescript, I am also endeavouring to procure. But there is a hardy palm growing along the Straits of Magellan, and spoken of in *Viage al Estrecha de Magellanes*, p. 316., which would, no doubt, answer in our pleasure-grounds, and deserves to be introduced, as might be easily done by some of our men of war or merchant ships coming from the west coast of America through those straits. Humboldt enquires respecting this palm, which also is a dwarf, "*Cujusnam familiæ planta tripedalis, frondibus pinnatis, Hispanis peregrinatoribus Palma Magellanica dicta, latitudine australis 53° proveniens, Phœnici dactyliferæ similis?*" † By inserting this notice in your Magazine you may perhaps call the attention of some of our travelling botanists to this imperfectly known plant, and secure its introduction as an embellishment to our English landscape. It could hardly fail to thrive in our southern counties. — *W. Hamilton*. 15. Oxford Place, Plymouth, August 28. 1830.

Eruberant Bloom of a Yucca gloriosa at Wanlip Hall. — This plant had stood for some time in the gardens of Wanlip Hall, where it had attained considerable size. In 1827 it flowered for the first time, and, as the flower stem decayed, the old plant put forth four shoots, which have flourished exceedingly since that period, and the bloom I am about to describe is from one of them; leaving three others which, to all appearance, will flower another season. In the spring of this year I formed an artificial rockwork around it of granite, which appeared to suit it extremely well, and I have no doubt contributed to the extraordinary fine blooms it produced. It began to flower on the 20th of July; the height of the flower stem was 5 ft. 8 in.; the side panicles were 36 in number, each panicle bearing on an average 24 blooms, making a total number of 864 flowers.

A Cereus speciosissimus, which is now four years old, began to flower on the 30th of May, and produced, in succession, eleven very large and splendid blossoms, nearly of a size. The dimensions were as follows: — The stems of the plant, which are four in number, measure 5 ft. in height; the petals of the flowers were 3 in. in length; the circumference 1 ft. 6 in. It had no other than green-house treatment, was planted in a wide-topped 32-sized pot, in a soil composed of sandy loam and lime rubbish in equal parts.

Pelargonium zonale var. Bluchèri succeeds better with me than any other of the scarlets. I planted one in the autumn in a wide-topped 48-sized pot, in a common green-house. The circumference of the leaves of the plant was 23 in.; the flower stem 1 ft. in length, with an umbel of flowers 40 in number, of which 32 were expanded at one time; the petals averaged in length 3 in. — *William Matthews*. Wanlip Gardens, Leicestershire, October 31. 1831.

* "From 2 to 3 ft. in height, fruit three-celled, about the size of the cocoa, albumen eatable."

† "To what family belongs a plant 3 ft. high, with pinnate leaves, called Palma Magellanica by Spanish travellers? It is found in lat. 53° south, and resembles the Phœnix dactylifera."

Nerine crispa (as it is here called, although it is probably *N. humilis* of Curtis's *Bot. Mag.*) and *N. undulata* live and flower at the foot of an old wall here, with no protection but the wall: both are very elegant. — Henry Turner. *Botanic Garden, Bury St. Edmunds, October 11. 1831.*

Produce of a Cucumber Plant near Rochdale. — Sir, The seed of Bloor's white spine, of last year's growth, was sown on the 30th of May, in a frame already at work, heated by steam passing through stones; and the young plant growing very strong, those cucumber plants already in the frame were cut out, as it required room; the old mould unavoidably remaining unchanged. Not being an experienced grower, I think some of them are large, considering this disadvantage. No. 9., in particular, was superior to any thing known to be grown in this neighbourhood.

No. 1.	Inches. Length	Girth	Inches. 8 1/2	Weight	lbs. oz.	Cut, Aug. 18
2.	22 3/4	-	10 1/2	-	5 6	Sept. 24
3.	24	-	9 1/2	-	4 8	
4.	19	-	8 3/4	-	2 14	Oct. 4
5.	21 3/4	-	8 1/2	-	3 9	8
6.	17 1/2	-	8 1/2	-	2 8	16
7.	18 1/2	-	7 1/2	-	2 5	20
8.	19 1/4	-	7 1/2	-	2 8	27
9.	28 1/2	-	10 1/2	-	6 9	29
10.	18 1/2	-	9	-	3 1	Nov. 12
				Total	36 10	

This plant was under the care of Mr. James Lee, at Harehill Mill, near Rochdale, who is no gardener; and this is his first attempt. The girth is the average taken at about 2 1/2 in. from each end, and the middle. No. 9. varied less than half an inch at any intermediate place, and several of the others are equally well proportioned. I remain, yours, &c. — J. S. *Near Rochdale, November 14. 1831.*

IRELAND.

Armagh Palace Gardens. — The chrysanthemums have been finer this season than I ever remember; some flowers measured 5 in. in diameter in the green-house; and even now, though so near Christmas, they are beautifully in flower in the open borders. Carnations and picotees are at this moment also in flower; not a straggling plant here and there, but by hundreds. Indeed, such has been the mildness of the season, that queen stocks, *Gilia capitata*, *Anagallis grandiflora*, and *Medicago arborea*, are likewise finely in flower; the last in perfect beauty. I am, Sir, yours, &c. — J. Elles. *December 23. 1831.*

The hanging Gardens of Limerick are a great curiosity. An acre of ground is covered with arches of various heights; the highest 40 and the lowest 25 ft. Over these arches is placed a layer of earth, of 5 ft. thick, and planted with choice fruit trees and flowers. The arches are employed as cellars for spirituous liquors, and will hold nearly 2000 hogsheads. The work was commenced in 1808, and was completed in about five or six years. The expense of the whole undertaking was nearly 15,000*l.* — John Ryan. *Newry, September, 1830.*

ART. V. Hints for Improvements.

PRIZES to young Gardeners by Horticultural Societies. — Sir, In your Volume V. p. 713., you have given some hints to Provincial Horticulturists. — Vol. VIII. — No. 36.

tural Societies, on the subject of offering prizes. Allow me to add to these hints, the idea of stimulating young men to self-improvement. For instance, there are, in the neighbourhood of Liverpool, six public nurseries, several market-gardens, and a great number of private gentlemen's gardens, in which are a number of young men or boys, from the age of 14 to 20 and upwards, who are placed there for improvement. A number of these, I am led to think, require some stimulus to induce them to study diligently, and acquire the practice of their profession in a superior manner. Perhaps some prizes of the following description might be offered. At the beginning of the season for botanical excursions; say, for the first hundred dried specimens of British plants, named and arranged according to the Natural System, so much, or such an article. At the end of the botanising season, or in November; for the greatest number of specimens of British plants, dried, named, and arranged in the course of the year. To the best namer of plants, as they stand in the Horticultural Society's show-room for inspection, either at one meeting or several meetings. For the most rare British plant discovered during the season, with its name, description, &c. For the best self-educated individual in writing, arithmetic, drawing, measuring, &c., specimens to be signed by his master, or some other respectable person. For the best design for laying out a garden or pleasure-ground; the competitors to be furnished with a ground plan, exhibiting the outline and the variations of the surface, or to have a piece of ground pointed out to them, or described. The prizes might be catalogues of plants, or other books, cases of instruments, boxes of colours, measuring lines, &c. I shall be happy if these hints lead some more competent person to take the subject into consideration and improve on it; and, I remain, Sir, &c. — *James Rollings. Liverpool, Jan. 7. 1830.*

Horticultural Societies in the Suburbs of London. — Sir, Horticulture is perhaps one of the most interesting and innocent sources of amusement that can be fixed upon, to fill up those hours which most people feel it necessary to devote to recreation, with a view of diverting the mind from too intense application, either to business or study. From local circumstances, very many are precluded from the pleasure of a garden; but, where even a small one is attached to a house, if the air is tolerably pure, any one, with a little taste, may find ample amusement in the cultivation of it.

It is, no doubt, a great misfortune, that builders are not more alive to the advantages, or, perhaps I should say, that persons are not more sensible of the pleasure, of a garden; we should then have, instead of filthy streets, cottages detached, with a garden to each, sufficient to employ and give interest to the tenants. Could, therefore, means be devised to introduce a more general taste for gardening, particularly in the vicinity of the metropolis, it would, no doubt, contribute greatly to the health and happiness of many individuals. To forward this taste, and to render the pursuit more interesting, nothing, I conceive, has so great a tendency as the formation of local horticultural societies. In the neighbourhood of the capital, the Horticultural Society unfortunately nets as a bar to the establishment of local ones. Most of the principal residents having a taste for plants, &c., are members, and therefore do not consider it necessary to patronise the formation of societies in their immediate parishes. I am not acquainted with the regulations of the London Society, and therefore am not aware how far it is open for the reception of plants, fruits, &c., for exhibition, from persons not being members: but however liberal the rules may be, in allowing the public to forward their finer specimens for view, and bestowing rewards where any great merit is displayed; yet it must be obvious, how very few, from distance and the inconvenience of sending, could avail themselves of the privilege. May I, therefore, solicit your indulgence for a page in your Magazine, to suggest to those gentlemen who

have influence, and who live in the vicinity of the metropolis, the propriety of endeavouring to form horticultural societies, on a plan similar to those in the country; principally with a view of having a certain number of exhibitions during the year; to distribute rewards; and, above all, where the funds will admit, to establish garden libraries. I reside in the neighbourhood of Clapham; in this and the adjoining parishes there are numbers of wealthy and estimable characters, always ready to contribute liberally to relieve the wants of their less fortunate neighbours, and to forward any object likely to be productive of good to them; now, I take the liberty of calling upon them, to endeavour to found a society of the above description; as I feel satisfied it will be attended with very beneficial effects. At present, I am afraid, there is not much taste in Clapham or the adjoining parishes for horticulture; and I believe there are very few, even of the higher or wealthier inhabitants, that have any fondness for plants; amongst the middling classes, it is limited to a few horticulturists. Now, I do not hesitate to predict, that, should a society be formed in Clapham, Stockwell, &c., we should soon have a great accession to the number, anxious to promote this delightful art; and I should expect to find, in a very short time, that the accounts of the meetings would form a very prominent part of your Gardener's Magazine. Fully relying, therefore, that some spirited individuals will take up this matter, I have only to assure you that I am, with great truth, yours, very respectfully, — *E. London, July 22. 1831.*

We have seen a proposal for a Gardeners' Joint Stock Annuity Fund, and also for a Metropolitan Garden Society and Benevolent Fund, the profits of which are proposed to go in aid of the Annuity Fund. We understand these proposals will soon be submitted to the profession in and about London. They appear to us well calculated to benefit gardeners, by teaching them how to take care of themselves, and enabling them to do so at the same time. We have no faith in charitable institutions, but a great deal in labour. "God helps them that help themselves." — *Cond.*

ART. VI. *Retrospective Criticism.*

CORRECTIONS for the Encyclopædia of Gardening. — Sir, As you have expressed yourself anxious to receive hints for the improvement of your *Encyclopædia of Gardening*, I beg to submit to your discretion two or three, which have occurred to me, as I looked over the book in question *passim*, without, however, searching for any thing of the kind.

First, in your statistic tables of the counties, you entirely omit, in this county (Dublin), any mention of Counsellor West's magnificent gardens and well laid out grounds on Mount Anvil Hill, within about $4\frac{1}{2}$ miles of this city; whereas, you blazon forth Mr. Bourne's, of Terenure, which are in every respect inferior to the former.

The fact is, Mr. Bourne's grounds are ill arranged *ab origine*, and worse kept, although much money is spent on them; but Counsellor West's place is maintained at an expense and with a care wholly unequalled in this country. Lest you should not have any description of this place, I shall give you an outline. The garden consists of about 4 acres, divided into three portions by walls running east and west. It is on a gentle slope to the south. The upper quarter, for the choicer fruits, contains a magnificent range of stoves, metallic curvilinear-roofed, and 120 ft. by 20 and 14 high, containing a splendid collection of vines in a front border 40 ft. wide; pines; and a large collection of tropical fruits, all fine specimens: the whole finished in the most exquisite style; walls painted in oils inside;

hot-water pipes to all. Next division, the finer sorts of vegetables, and fruits. Third division, pine pits on Weston's plan; melon and cucumber yard, vegetables, &c.; asparagus is in great perfection, on a bed drained 5 ft. deep, with granite boulder stones. Below this last division is an extensive and well kept nursery for trees and shrubs. The garden is entered from the house side, first through a fine shrubbery walk of great length and beauty, and then through a large piece of ground intended solely for flower ground, commanding one of the finest views of the Wicklow Mountains conceivable. This piece of ground is intended to contain a large and splendid conservatory and orangery. Its western boundary is formed by the east wall of the garden, which is about 200 yds. long, and through its whole length covered with a rare and thriving collection of climbing and creeping plants, and all the most valuable tender shrubs. The present mansion, already condemned, is not handsome, but commands a view of Dublin Bay of the most magnificent description; more like an Italian than an Irish scene. Mount Anvil Hill is the name of the place. If you wish for more information about it, send me word and you shall have it.

In your information about making artificial ponds or aquariums, I think you are a little deficient. In gardens where worms are plentiful, an aquarium cannot be formed merely of clay; as the worms all collect to the water, and pierce holes in the clay, and thus let the water off. This I found by sad experience, only last summer; and in a loamy, sandy, porous garden soil, abounding in worms, I made an aquarium, which has ever since remained perfectly staunch, and in which I have got all the Irish aquatics thriving. The aquarium (*fig. 30.*) is an ellipse of 30 ft. by 15. *a a* are

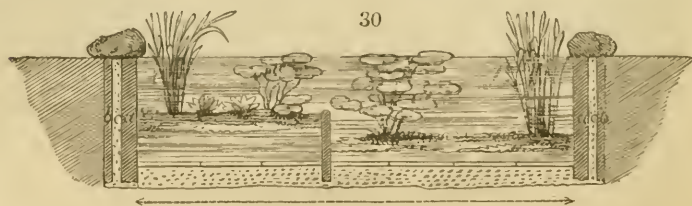

the sections of a 9-inch brick wall, surrounding the whole; between which and the outside 4-inch walls (*b b*) is a space (*c c*) of 4 in. for holding puddle and salt to keep the worms off. The bottom is composed of flags jointed with Parker's cement, and laid on a bed of well beaten mud or puddle, so dense and dry as not to yield readily to the foot: it is continuous with the puddle of the walls, and under it the ground is well salted. The pond is divided by an arched wall (the convex curve of the arch against the shallower side) into two parts of greater and less depth. My pond is in my rockworks, where I have a large circular one also, and is edged with a border of rockwork, growing such plants as like much moisture. It is supplied by a source which bursts up through the rocks at one end, and trickles into the pond. It looks remarkably pretty, and answers well. I think this plan admirably adapted for making small ponds in all dressed grounds, pastures, &c.

Amongst the exotic fruits, you do not mention the winter cherry (*Physalis peruviana*), which I think is worth a place; the flavour of the fruit is pleasant, and I believe it is wholesome, although it belongs to a suspicious family.

In your chapters about gates, fences, &c., you might take notice of Mr. Telford's gates of iron (*fig. 31.*) on the Holyhead road, made of flat bar

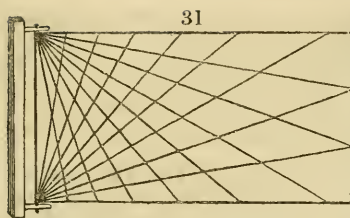

iron; a rivet at every intersection. You will see that a better mechanical arrangement of forces could not be made.

I think your observations on anomalies of horticulture, and keeping accounts without writing, are very trivial, and ought to be omitted. I am, Sir, yours, &c.—*Robert Mallet. Ryder Row, Dublin, Feb. 9. 1831.*

Corrections for the Encyclopædia of Plants.—Sir, In the *New York Farmer*, vol. iii. p. 149., and in vol. iv. p. 59., are a number of corrections. The writer dwells, and justly, upon the apparently sneering notice taken of “a Mr. James Logan, said to have been the author of some experiments upon the generation of plants.” As I do not suppose you were the author of that remark, I cannot help saying that it is either a mark of the ignorance or the superciliousness of whoever made it, for either of which he deserves censure. The work of Logan was written while the author was on his travels in Europe, in Latin, and translated by the celebrated Dr. John Fothergill, and it does honour to Logan, who was chief justice of Pennsylvania, and one of the most learned men of the day.—*J. Mease. Philadelphia, May 16. 1831.*

Gymnocladus canadensis, the Kentucky coffee-tree, which in your *Encyclopædia of Plants*, p. 842., you denominate a “tree or shrub,” and describe as “twining about the neighbouring trees and shrubs;” is no shrub; neither does it twine at all. It is a perfectly straight tree, 80 ft. high, and abounds in the Western States. As Michaux has described it fully, it is singular that any mistake was made about it. Its seeds are used for coffee.—*J. M. Philadelphia, March 6. 1831*

Irish Cottages, &c.—Sir, Mr. Howden, in the article on the mud cabins in Ireland (Vol. VI. p. 657.), has very unjustly indulged his wit at the expense of my country and countrymen. I believe I am correct when I state that his services at Lord Doneraile’s “did but render very indifferent satisfaction.” If he had not such a good cottage to live in, therefore, as the one he now occupies, it is probable his employer did not think him entitled to any thing better.—*Thos. Small. Near the Church, Bexley, Kent, Nov. 29. 1831.*

Giving the Credit to Gardeners which is due to their Employers.—In several of your Numbers, in alluding to horticultural improvements that have been effected or were in contemplation, the gardener has had the merit of design and execution, and the owner is confined to the mere duty of paying for them. Throughout your pages I could quote a thousand instances where the master and the servant are so confounded (except possibly, to local knowledge), that something like Lear’s enquiry as to “which is the justice, and which the thief,” is necessary to determine the distinction. I will, however, content myself, for the present, in referring to your last Number (Vol. VII. p. 540.):—“We have strongly recommended Mr. Dodd, gardener to Sir James Graham at Netherby, to adopt metallic curvilinear houses and hot water in the erections which are about to be made in the kitchen-garden there, and we trust that *he* will not forget our recommendation.” In thus inviting the servant to adopt a particular and extensive arrangement, without the slightest even complimentary reference to his master, are you not injuring him, by embodying against him that natural offence which wounded pride must ever feel at unauthorised assumption? If Sir James Graham could for an instant consider that his gardener encouraged or participated in your attempt to raise him above his station, I think the baronet would be deserving the condition to which you (perhaps inadvertently) have sought to lower him, if he did not allow Mr. Dodd to seek for another site than Netherby for the adoption of

your suggestions. In a previous Number (Vol. V. p. 510.), in reporting the splendid improvements in progress at Syon House, you ascribed all praise, not to the worthy and talented nobleman who planned and paid for them, but to the agent charged with the execution of his orders. Your commendation would probably have cost the gardener his place, could His Grace have condescended to a rivalry in your commendation. I am, Sir, yours, &c. — *A Friend.* Dec. 1831.

The leathern Wallet and the leathern Bearing-Straps (Vol. VII. p. 613.), are, surely, not worth engraving; they are quite common about this town, and, I think I may say, throughout the east of England. — *T. S. Bury St. Edmunds, Nov. 1831.*

The wallet is scarcely known in Scotland, as Mr. Hislop, who lent us both the wallet and strap, can attest. If it were better known in that country, there would not be so many blue aprons torn to pieces. We consider articles of this sort, calculated for universal adoption, when they are not universally known, as among the most useful articles that we can figure. — *Cont.*

Supporting newly transplanted Trees by pegging down their Roots. — I beg to inform your very intelligent but sensitive correspondent, Mr. Thom (see Vol. VII. p. 445.), that I put in my claim to a new method of supporting recently planted large trees; though I hitherto thought it of very little consequence, having found it so well known wherever I have operated, that I fancied every one knew it. I have practised it for upwards of thirty years without a failure. The method is, to drive down strong hooked pegs to secure the main roots. They must be of some kind of hard wood, not apt to split. I have generally used oak or elm; but various other woods will answer. Each large root will require three or more pegs, driven firmly into the hard subsoil, and, to prevent friction, there should be a considerable quantity of moss put between the root and the hook. When the hole is filled in, the hooks are completely covered, and they generally last as long as they are necessary for supporting the tree. The heads of the pegs should be left, at first, of considerable length; but when driven home, they should be sawed off a few inches above the hooks. The pegs will often require to be 3 ft. long, and 3 or 4 in. in diameter at the head. In most cases, it will be necessary to make holes for the admission of the wooden pegs, by the previous insertion of an iron one. I hope Sir Henry Steuart will approve of my method; and I trust that your intelligent correspondent, Mr. E. Murphy, will spread this practice, as well as many other useful ones. Judging from his judicious practical observations, I think there is no man more calculated to raise the science of arboriculture from the low state in which it has hitherto been in Ireland. I fear, however, that he will fail, as I have often done, to induce proprietors to thin their plantations. Many in the county of Cork have got into the wretched method of pruning their forest trees, especially oaks, like fishing-rods; and neglecting to thin their plantations till the trees become so weak as to be unable to hold up their heads; and, consequently, when thinned, they require many years before they are able to bear exposure to the weather. I am, Sir, yours, &c. — *H. Dutton. Lombard House, Middleton, Nov. 1. 1831.*

The Edges of Walks, Dotting, Grouping, &c. — Sir, I have been much gratified with your remarks (Vol. VII. p. 404, 546.) on the depth of walks, and on the nakedness and spade marks often visible on their edges. I have long been convinced that this prevalent negligence and want of finish have a very bad effect; and those borders which I have laid for some years past are much lower than the usual practice allows. I never had the resolution, however, to alter the rest, till I found my own conviction confirmed by your excellent remarks. I also agree with you in your views respecting the prevailing mode of placing groups on lawns (Vol. VII. p. 401.

fig. 72.) ; but I would like to ask whether it is in good taste, to preserve an equal breadth of grass on each side of the walk, as you seem to suggest ? [Not more than is necessary to maintain the principle of a whole, or of every part fitting into its precise situation.] It appears to me that there are two great errors in the laying out of walks in gardens and shrubberies. The first is, that the borders are generally edged with a stiff parallel stripe of grass, which cannot fail to be tiresome to the eye. Now, it is evident, that if nature (the best guide) is to be followed, the borders of walks should be of unequal breadth, and varied ; otherwise, the uniformity, which in its due proportion is pleasing, becomes very tiresome. The second error is, that walks and roads are very frequently twisted fantastically through the grounds, without regard to taste and propriety ; and in violation of a very obvious rule, viz., that if any change be made in the direction of a road from the nearest line, for the sake of leading to some view, or of taking in some agreeable undulation in the ground, it is necessary to have an apparent or real cause to account for every turn which the



path makes in its course. To effect this purpose, plants, raised or lowered ground, rock, wood, water, or any thing that will harmonise with the situation, may be employed. That you may understand my meaning better, I subjoin a sketch. (fig. 32.) I am, Sir, yours, &c. — T. D. *Broughton Hall Gardens*, Nov. 26. 1831.

The principle of a sufficient reason ought never to be lost sight of in laying out walks and roads ; that is, no deviation from a straight line should ever appear, for which a reason is not given in the position of the ground, trees, or other accompanying objects. (*Encyclopædia of Gardening*, 2d edit. s. 7243.

The Practice of Dotting, which you have so very properly condemned (Vol. VII. p. 403.), is not so much to be laid to the charge of gardeners, as to gentlemen themselves, or to their land-stewards or bailiffs. There is not one gardener in a hundred that is ever allowed to have any thing to do with the single trees in the park or lawns of the residences where he is gardener. This, and this alone, is the reason why dotting prevails instead of grouping, and why our parks are spotted like a leopard, or checkered like a draught-board, instead of presenting marked features, breadth, masses, and repose. — *A Single Tree*. *Bewdley*, Nov. 30. 1831.

Certain Plants alleged to be hardy in Sweet's British Flower-Garden. — It is to be regretted that E. (Vol. VII. p. 709.) has not enumerated more of "the very considerable number of plants" which he has lost from having placed too much reliance on catalogues, &c. He has only named two ; viz. *Erpètion renifórmis*, and *Campanula púlla* : the last I have always treated as a hardy plant ; but I was not before aware that Mr. Sweet had represented the *Erpètion renifórmis* as hardy. Knowing it to be a native of New Holland, I have been agreeably disappointed to find that it has survived the last two winters here in a cold wet situation, without any protection whatever. I find it has also proved to be hardy in the Clapton Nursery. I am, Sir, yours, &c. — T. B. *Stamford Hill*, Dec. 29. 1831.

Certain Plants alleged to be hardy, &c. — Sir, I am sorry to see in the Gardener's Magazine (Vol. VII. p. 709.) an attack made by E. upon Mr. Sweet, for having represented some plants as hardy in the *British Flower-Garden*, which had perished during the winter under the management of E. From the endeavours of the editors of the different botanical periodicals to give early figures of new and interesting plants, it is surprising that so few mistakes occur. E. might, with equal propriety, com-

plain of all the other periodicals, either for representing plants as hardy which will occasionally perish during winter out of doors, or for putting him to the expense of building houses for others which Mr. Sweet has proved experimentally will thrive better in the open air. If E. had occasionally visited Mr. Sweet's garden at Chelsea for several years past, he might have witnessed the different methods recommended in the *British Flower-Garden* for the protection of half-hardy plants put into full practice, and with complete success.

Of the two plants named as examples of serious losses, *Erpètion renifórmis* is well known to be rather tender; but, with less than common care, it ought to have been perfectly safe in a cold frame. *Campánula púlla* is perfectly hardy, if planted in a suitable soil. Mr. Sweet gives very particular directions about the compost requisite for it; and in such a mixture I have grown it for six or seven years without care or protection, only having occasionally to grub a part of it up when spreading too wide upon the border. But why have said, "It does not follow that because some of the plants in question may have survived for twelve months in the borders at Bury Hill, &c., that Mr. Sweet can be justified in recommending to his readers a practice which must inevitably expose them to serious losses;" when it appears, by referring to the *British Flower-Garden*, that neither of these plants was figured from Mr. Barclay's garden, which, by the by, from its peculiar locality, would be too severe a trial for many hardy plants? The garden at Bury Hill, lying low in a valley, without artificial protection, exposed to the wind from every quarter, and subjected to the very latest frost in spring, and to the very earliest frost in autumn, with the common garden soil, must be allowed to be by no means favourable for the preservation of herbaceous plants during winter; and, therefore, if a plant stood the winter in such a situation, it might safely be considered hardy, especially when we hear of New Holland, Cape, and plants from other warm countries, growing out of doors in several gardens in Scotland, for years, with very little protection afforded them during winter. As an anonymous attack deserves an anonymous answer, I shall sign myself—*F.* Dec. 7. 1831.

Erpètion renifórmis hardy. — Sir, E., in his reproofs of Sweet's *Flower-Garden* (Vol. VII. p. 710.), speaks of this plant as tender: my experience disagrees with E.'s. With me, it withstood in pots, and without protection, the severity of the winters of 1828-9 and 1829-30. *Campánula púlla* is perfectly hardy, as the flower-borders here annually prove. — *Henry Turner. Botanic Garden, Bury St. Edmunds, Dec., 1831.*

Propagation of Orchideous Epiphytes. — Sir, Permit me to add a few remarks to your description (Vol. VII. p. 541.) of my mode of increasing these most lovely plants. My first trial in this way was on a large plant of *Cattleya crispá*, which had eight old shoots and two young shoots gone over the side of the pot. I took a sharp penknife and cut the plant through carefully in three places, taking care not to disturb the plant, nor cut any roots; to my great surprise, in a short time I had two fine young shoots at the side of each old shoot where I had cut, giving me eight young shoots in all; and, I believe, had I cut the plant through at the side of all the old shoots, I should have had sixteen young shoots. I should say in this place, that the two young shoots that were on the plant before I cut it through did not suffer by the cut. I think they grow equally as strong as before, and faster, which makes me think that the old part of the plant is of no use to the young shoots after they have made their roots. I have been informed by a botanical friend, that this method of increasing the parasitical plants will not succeed except on large established plants; but I have tried it on very small plants, and have found it to answer as well as on larger ones: of course, the more old shoots there are, the more young ones there will be. I have tried it on most of the species here, and

find it to answer equally well on all. I will name two species which had only two shoots in each pot when I divided them, viz. *Onocidium papilio* and *Brassia caudata*, and they soon after attained two young shoots in each. The best time to divide the plants is just when they begin to grow. — *William Perrin, Gardener to Richard Harrison, Esq., Oakland Cottage, near Liverpool.*

Eránthis hyemàlis. — I coincide in J. D.'s commendations of this plant (Vol. VII. p. 564.). It would be worth J. D.'s while to go to the Grove at Mitcham (Sir J. Fulbock's), on purpose to see them in the spring; they cover the whole surface of the plantations, and are visible half a mile off; making a show like our yellow crowfoots in the fields. — *B. Coventry, Nov. 2. 1831.*

The Tea Plant. — I have been quite surprised at Mr. Main's remarks in Vol. IV. p. 454-5., on the subject of the tea plant: his remark is as follows: — That the green (*Thèa viridis*) and the black tea (*Thèa Bohèa*) are distinct species of the genus *Thèa*, there can be no rational doubt: the *toute ensemble* forms a characteristic difference between them, as marked as that of the sweet bay and the common laurel. The green tea can by no modification whatever, either of culture or clime, be obtained from the same plant that yields the multiform varieties of black tea, from inferior bohea through congou, up to pekoe, and padre souchong. The fact is, green and black tea are chemically different. By acting on green tea by means of boiling alcohol, I have dissolved resin, vegetable wax, and the green matter (chlorophyle) of the leaf. The leaves by this treatment become black, but do not unfold. An officer of high rank in India informed me that when his camp was visited by Tartar tribes they were surprised at the black tea then used, which they had seen for the first time, green tea being that alone cultivated by and used among them. — *J. Murray, Dec. 1828.*

Censurable Names given to Gooseberries, &c. — I see that Mr. D. and you are both converts to the big gooseberries. As trying is, in such cases, believing, I intend to try a few of the best of these giants, particularly Woodward's Whitesmith, which Mr. D. speaks of so highly in the note (Vol. VII. p. 332.) appended to my notice of small gooseberries. I also mean to get, if only for curiosity's sake, the true Warrington. I wish they would not give quite such low, vulgar, pot-house names to their gooseberries; names, too, that do not possess the merit of being any way peculiarly applicable or descriptive, to compensate for their vulgarity; e. g. Roaring Lion, Crown Bob, Jolly Printer, Jolly Angler, Cheshire Lass, Royal Rock-getter, and, to crown all, "Leigh's Fuddler." I cannot conceive any thing more low and blackguard, unless you descend to downright indecency and obscenity. — *B. Coventry, September, 1831.*

British Society of Agriculture. (Vol. VII. p. 498, 499.) — Sir, I perfectly agree with you, in opinion respecting the little utility of such associations in general, and therefore cannot hail the projected one as likely to produce the intended good. Too many, I am afraid, have either originated as jobs, or degenerated into such, by the selfish conduct of individuals; and as this is the opinion of the great body of the farmers, societies like the above cannot be of much use until this belief is removed. It may also be doubted whether the studies Mr. Hawkins points out can be immediately beneficial to society. Is it not more probable that better systems of cultivation introduced into the more backward counties, by the examples shown by specimen farms, would have a much greater effect, in promoting the desired objects? Though I do not deny that natural history, chemistry, &c., may occasionally be of considerable use to a farmer; yet, attempting to exaggerate their utility is not the way to bring them into credit amongst the mass of the people. The commercial farmer has his landlord and family to attend to, before he can afford to spend valuable time in making experiments, of which the chance against his ever being able to profit is

very great, besides the certainty of getting himself laughed at by his industrious plodding neighbours. No doubt the more general diffusion throughout the country, by local colleges, or even periodical lectures, of those branches of knowledge which are not to be acquired at the common country or day schools, may do much good, by exciting all, and enabling many, to apply barren knowledge to the affairs of life, with a readiness and precision which only some fortunate individuals can at present attain. Your correspondent partly illustrates this; but if he had removed the beam from his own eye, previously to his attempt to take the mote from the eyes of his neighbours, and possessed a small knowledge of political economy, it would have shown him the fallacy of the doctrines of Webb Hall, and have prevented him from using arguments, the errors of which every tyro must detect at first sight, and which, in fact, caused the withdrawal of the government support, and the consequent breaking up of the Board of Agriculture. It is really melancholy to see the errors into which the most humane and kind-hearted men fall, from overlooking or contemning the science, which is as necessary in enabling us to view correctly those plans for benefiting society, as arithmetic is for estimating and noting the riches of individuals. If a society is to be established, then, to prevent its failure, Professor Macculloch, Professor Senior, or Dr. Whately, ought to furnish or revise the rules, and, if possible, to give a preliminary lecture upon the legitimate objects and advantages to be expected from such an association. I cannot conclude without mentioning the liberality of the clergy of this diocese, who have offered to endow two professorships at the new provincial college to be established at Durham, by setting aside for their support the revenues of two or three of the stalls of the prebendaries. I am, Sir, yours, &c. — *A Northumbrian*. Nov. 29. 1831.

ART. VII. *Queries and Answers.*

HEATING a Conservatory and Bath from the same Boiler. — Your Magazine has set me, and many others of my acquaintance here, experimenting on some of the numerous inventions detailed in it. For example, I have added to my cottage residence a conservatory, forsooth, on something like the following plan: —

33

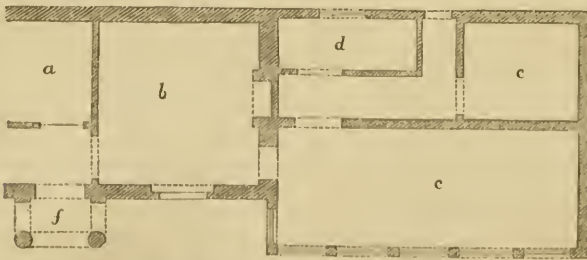

a, Dwelling-house. *b*, Parlour. *c*, Conservatory. *d*, Bath. *e*, Place for boiler.
f, Entrance porch, facing the south.

The conservatory has a glass front, and the front part of the roof is glass, the back part being slated. Attached is a bath, sunk on a level with the floor. Now, the cause of my troubling you is to endeavour to ascertain from you, or some one of your scientific readers, the best plan of heating the conservatory and the bath from the same boiler; the size of the boiler, of the pipes, of the reservoir, &c. I suppose the thing can be done; if not, I shall lay all the fault at your door. — *Cymro*. *Brecon*, Dec. 1831.

Nothing in the way of heating by hot water can be easier. We recommend such of our tradesmen readers as are in the habit of putting up hot-water apparatus to write to Cymro, Post-office, Brecon, and Cymro to apply there for letters. — *Cond.*

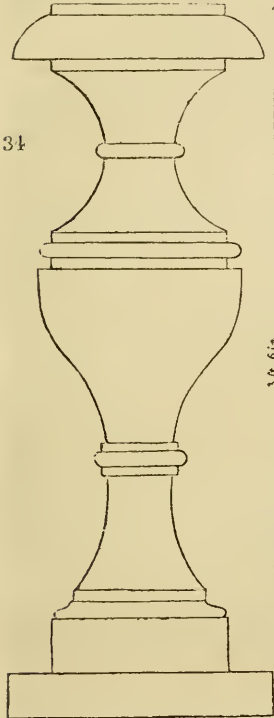

where it was erected; and MacQueen was the architect, as the drawing seemed to be by him. The late Mr. James Brown, who

The Price of Garden Ornaments, in Stone, at Dumfries. — Sir, Your correspondent O. P. Q. has very properly improved your hint respecting our cheap and ornamental tombstones. As Mr. Newall is at present in Italy, I sent the query to a very ingenious builder and mason, who owns a quarry of the best stone in Dumfriesshire, Mr. M'Gowan. A fountain made of that stone, similar to the engraving (Vol. VII. p. 724.), would cost at Dumfries 11l. 11s., and might be sent to London for 2l. or 3l. more. You may recollect my sundial (*fig. 34.*, scale 1 in. to 1 ft.); a similar one would cost here 1l. 15s. I am, Sir, yours, &c. — *Wm. Grierson. Baitford, Dec. 12. 1831.*

When we consider that the fountain referred to is 8 ft. high, the price seems remarkably low; it would cost more than double the money, in any stone whatever, if made about London. We have no doubt it would pay to have columns and other architectural members worked at Dumfries, and sent to London, and different parts of England. — *Cond.*

View of a House in Ireland. — Sir, I send you a sketch (*fig. 35.*), taken from a drawing found in the room of a late market-gardener of this place, John MacQueen, who died in rather a singular manner about a year ago. The reason I send you the drawing is, to request you will inform me, if you know if you do, I wish also to know whether MacQueen was the architect, as the drawing seemed to be by him. The late Mr. James Brown, who has been over the whole of Ireland as an

35

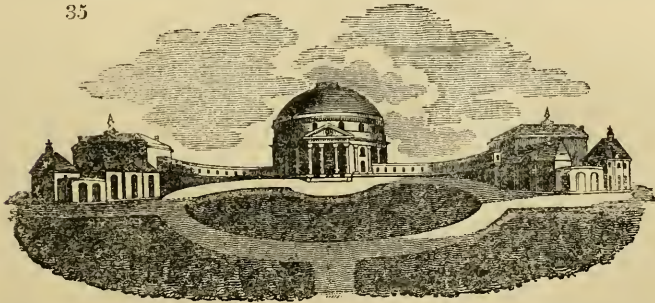

itinerant druggist, assured me, some months ago, that such a building did not exist in the whole country; and I therefore conclude it belongs either to England or Scotland. Speaking of MacQueen's death: he was a very

odd character; and, having drunk rather too freely, went out, as it is supposed, to turn over some hot dung which was in preparation for a cucumber bed; and having either fallen down, or laid himself along the dung to rest, he was found next day on his face, quite dead. He lived alone; but nevertheless left a sort of will, in which he bequeathed his body to the surgeons, on condition that they returned his bones, when they had done with them, to be ground into bone manure for his own garden. Observe, I do not vouch for this, though it is reported among his friends, and I believe it to be true. It is almost needless to say, that his relations paid no attention to his request. He was buried in the usual manner, but where I cannot exactly say. — *John MacLaggan. Londonderry, August, 1831.*

We insert the above query more on account of the drawing (*fig. 35.*) than the notice of a drunken gardener. Notwithstanding the names at length, we cannot help having doubts as to the authenticity of the facts. We have certainly seen either an engraving or a house something like the drawing sent; probably in some book. — *Cond.*

A Machine for hewing Stones by Steam was invented by Mr. James Milne of Edinburgh, two years ago; can you, or any of your readers, inform me if it continues to answer, and whether it would apply to basaltic or granitic rocks? If so, it will be of immense use in this country. — *I. W. New York, Sept. 1831.*

A would-be Suburban Gardener. (Vol. VII. p. 720.) — Should no one better able than myself furnish the information desired by A would-be Suburban Gardener, I will, in a future Number, endeavour to do so. I should, in that case, like to occupy a page or two, to give a list of ornamental plants, and a few hints respecting their culture, which, if attended to, would preserve A would-be Suburban Gardener, and many others, from the frequent disappointments to which they are now exposed; and which, no doubt, tend to destroy their zest for gardening pursuits. I am, Sir, yours, &c. — *William Boyce. Rochampton, Dec. 28. 1831.*

A Grub-worm is making sad havoc among my strawberries, intended for next year's forcing. Can you or any of your readers inform me through the Gardener's Magazine, how it may be destroyed? — *John Stovell. Petworth, Nov. 1. 1831.*

History of the Lombardy Poplar (Pópulus dilatata). — Sir, In your last Number (Vol. VII. p. 716.), J. D., speaking of the wood of the Lombardy poplar, observes that it "is remarkably light when dry, and is usually but lightly esteemed: for in-door purposes it is, however, said to be excellent. Hence the following couplet appertaining to it:—

‘ Though heart of oak be e'er so stout,
Keep me dry, and I'll see him out.’ ”

I cannot speak from experience of the timber, but have always heard it represented as the most worthless of woods. The above couplet, or one to the same effect, I have often heard applied to the Spanish chestnut; but it cannot, I think, have been originally intended to apply to the Lombardy poplar, because the couplet itself is of far more ancient date than the period of the introduction of that tree into this country. J. D. speaks also, though he speaks doubtfully, of the value of poplar wood on account of its "igniting very slowly." (Does he say this of poplar timber in general, or does he confine the remark to that of the Lombardy poplar in particular?) [J. D.'s remarks were rural traditions transcribed, which his experience neither enables him to negative nor confirm: they related to the timber of poplars generally, or rather to the British species, *P. nigra*, *álba*, and *canescens*.] This is the character also of other species of poplar, especially the abele (*P. álba*), of which wood, or of the *Pópulus canescens* (I am not sure which), grown upon the estate, the chamber floors of the present mansion at Newbold Comyn, near Leamington, are constructed. They are of a

light colour, and remarkably neat. The timber of the abele (*P. álba* or of *P. canéscens*, whichever it may be) was selected for this purpose (as I have often heard from the late possessor of the property) for the very reason hinted at above by J. D. An abele (or *P. canéscens*) of very large dimensions grew, long since my recollection, upon the small narrow island in the river immediately in front of the house at Newbold, but it has been cut down some years.

Larch. The timber of the larch, though, like other trees of the fir tribe, it abounds with turpentine, is yet, contrary to what we should expect, remarkably slow in igniting, and may almost be said to resist fire. A friend of mine once had occasion to cut down some old larch trees, and thinking that they would make particularly good firewood, he had them cut into logs for that purpose, and reserved for his own use. To his utter surprise, however, he found that they would scarcely burn; I do not mean that fire would not consume them, but that they burned extremely sluggishly, and made the worst fuel that can well be imagined. The same I have found by experience to be the case with the twigs and small branches of the larch. Can you account for this extraordinary fact, which is so contrary to what might have been expected? The larch, too, I am told, has the property of resisting the effects of water as well as of fire. The value of this quick-growing tree as timber is, I apprehend, scarcely yet estimated as it deserves in this country.

Birch (Bétula álba).—Are you aware that the thin white bark of the birch, which peels off like so much paper, will burn like a candle? May it not be applied to some useful purpose? The wood and twigs of birch, too, burn remarkably brisk. Yours, &c.—*W. T. Bree. Allesley Rectory, Dec. 20. 1831.*

Polýgala vulgàris of different Colours.—Sir, Some apology is perhaps due from me to your correspondent G. J. P., for having misunderstood his meaning (Vol. VII. p. 246.), as it appears I did, respecting the varieties of *Polýgala vulgàris* (see p. 380.); and yet I know not how his words could well be understood in any other sense than that in which I took them. From his subsequent remarks (p. 717.), I perceive his meaning to be, that flowers of several different colours are sometimes found on the same individual plant of *Polýgala vulgàris*; and that he seeks an explanation of the phenomenon. Now this reminds me of the old story about the hoaxing problem once proposed to a learned society, viz. “Why a vessel filled with water, and with a guinea placed in it, weighs no heavier than the same vessel filled with water, but without the guinea?” Before we speculate on such questions, I should wish to be informed, on somewhat less vague authority, whether the fact be really so. Your correspondent says, “he finds on a neighbouring common the *Polýgala vulgàris*; the flowers are of four different colours, viz. dark blue, light blue, red, and white.” (p. 246.) All these varieties, i. e. specimens of the plant respectively bearing flowers of these several colours, are of frequent occurrence. In his last communication he tells us that he has read in some book (he forgets the title), that the flowers of *Polýgala vulgàris* are changeable, and that flowers have been found of several colours on the same plant; “but this,” he adds, “he never saw.” Neither have I; and if any of your readers have ever met with so unusual a party-coloured variety, it may be worth recording in your Magazine. I would not, however, be understood as absolutely denying the existence of such a variety, more especially as a similar anomaly, I am aware, is known to take place in some other cases; e. g. I have seen on the same plant of *Gerànium praténse*, in the Oxford Garden, blossoms, some of which were entirely blue, some pure white, and others striped, or partly blue (the usual colour) and partly white. *Centaurea Cýanus*, again, is not unfrequently to be met with in the gardens producing, on the same plant, flowers of four or more different colours, viz. blue, white, dark purple, or chocolate, and particoloured. And, only in October last, my attention

was called to a very handsome georgina in the nursery of Messrs. Young, at Epsom, which bore two different kinds of self-coloured flowers, as well as a third kind which partook of both colours beautifully intermixed; if my memory serves me, I think the variety was called by the florists' name of "William and Adelaide." How to account for these freaks of nature, which, from the above examples, it appears, occur chiefly among plants in a cultivated state, is a point I must leave to wiser heads. Yours, &c.
— *W. T. Bree. Allesley Rectory, Dec. 20. 1831.*

Cyclamen persicum. — Some queries on the fragrance of the blossoms of this species occur in Vol. VII. p. 562. It is known to vary into plants whose blossoms are all purple-eyed, or others whose blossoms have all white eyes. I rather think that among the purple-eyed plants, some are fragrant and some are not; and that among the white-eyed plants, the case is quite the same. The finest specimen I ever saw was one my father used to have when we were children; it was high fun for us to count the number of blossoms out at one time, which was enormous; they were very fragrant, and of the purple-eyed kind. — *B. Coventry, Nov. 2. 1831.*

The late Mr. Hobson's Books of Mosses. — In answer to B. of Coventry (Vol. VII. p. 124.), the late Mr. Hobson published several copies, as complete as he possibly could make them, containing each 300 species of mosses, and *Jungermánia*. If B. wishes any particular information respecting the 2d and 3d vols., he may have it by addressing a letter to me, post paid. — *Wm. Hobson, 31. Chester Road, Hulme, Manchester, Dec. 1831.*

Gentiana acaulis (Vol. VII. p. 728.) is best propagated by seed, which should be sown, as soon as ripe, in pots filled with loam and peat mould. The pots to be placed in the shade till the approach of winter, when they should have the protection of a cold frame. In the course of the next summer the plants will be large enough to be pricked off into other pots, filled, as before, and put in the shade. They should be kept in frames during another winter, and in the second spring they will be fit for final transplantation. It is necessary to observe, that if edgings are to be made of this plant, they should be planted, at least, four or five inches within the border or clump; and if planted in "patches quaint," should seldom be moved, as few plants suffer more by being disturbed. A moist rich loam is the best soil for this plant.

The Lady Bath Heartsease. (Vol. VII. p. 728.) — When I had the care of the splendid collection of plants belonging to T. Kingseote, Esq. of Kingseote Park, Gloucestershire, I procured the Lady Bath heartsease from Mr. Wheeler, nurseryman, of Warminster, who raised that beautiful variety, and named it in compliment to Lady Bath. I am, Sir, yours, &c. — *Wm. Boyce. Rochampton, Dec. 28. 1831.*

Amaryllis formosissima seeds in England; in reply to the query of Amaryllideus. (Vol. VII. p. 728.) — The Jacobæan lily used to bloom annually outside and in front of a conservatory in this town, but which is now no longer standing. Once at least, in this situation, it ripened seeds, from which plants were raised. — *Henry Turner. Bury St. Edmunds.*

Culture of Gentiana acaulis; in answer to S. W. (Vol. VII. p. 728.) — This plant grows luxuriantly in a garden near this town, planted in a very strong loam. It will also flower well in heath mould; but in a mixture of heath mould and loam, although it will grow strongly, it will rarely blossom at all. — *Id.*

Irish Pearl Moss. — Can you tell me what lichen it is, which is sold in Covent Garden Market under the names of oak lungs, carrageen, or Irish pearl moss, for medicinal purposes? I am, Sir, yours, &c. — *J. Elles. Palace Gardens, Armagh, Dec. 23. 1831.* [*Ficus crispus* var. 8 of Turner's *Historia Fucorum*, vol. iv. t. 217. f. c. See *Mag. Nat. Hist.*, vol. iii. p. 483. fig. 119.]

Melanthus major. — Are you aware that this plant is as hardy as the common artichoke? [Yes.] I have a few of them in some beds in the

lawn, where, along with yuccas, cannas, and Indian corn, they have a rich Oriental appearance in summer. — *Robert Redstead. Hampshire, Nov. 1831.*

How can I ripen Grapes by the middle of September, without Fires? — I want to have firm and large berries, in bunches, in time for the Doncaster races. Your advice, or that of some of your correspondents, will much oblige — *R. W. Doncaster, Nov. 1831.*

Beer from Sugar mixed with inferior Malt or unmalted Barley. — Has any of your correspondents experience in the making of beer from sugar mixed with very inferior malt or unmalted barley? There is every reason to believe that very bad malt and sugar, or unmalted barley and sugar, if coarsely cut in a machine, will make a beer equal to the best malt; and it is very desirable that this point should be clearly ascertained, as it would afford means of giving a very cheap drink to the people, at the same time, that it would extend the sale of barley, by giving it a chance of escaping the malt duty, as well as by giving an additional value to the worst part of the crop. Perhaps you would invite a discussion of the subject. — *X. Y. London, Aug. 29. 1831.*

Barley Bigg. — In answer to the queries of your correspondent X. Y., Vol. VII. p. 731. respecting barley bigg, which has this year been reintroduced, for the hundredth time, from Tartary, and cultivated in the Chiswick garden as a new grain, I would say, that the seed is usually to be obtained from the principal London seedsmen, as Gibbs or Wrench; but, if not there, it may be obtained with certainty from any Scotch seedsman at Edinburgh, Glasgow, or Aberdeen; though I remember, in the latter place, finding some extraordinary and unaccountable difficulties raised against procuring it, by Messrs. Walker, gentlemen in all other articles so intelligent, so liberal, so fair, so tradesmanlike, and so satisfactory. I do not apprehend that, without a special order or caution, the Scotch traders would point out or observe any distinction, or be particular in the sample, whether of the tetrastichon or hexastichon variety. It differs from spring barley in this particular, that, whereas the latter cannot be grown to advantage except in fine light soils, the former thrives very vigorously in stiff cold clays. The grain is produced in greater abundance than that of spring barley; it is believed to have a more nutritious farina, but the thickness of the skin and coarseness of the sample render it unfit for the maltster, though it will make substantial good barley bread, where that article is in use, and the distiller will occasionally make liberal use of it. But for those who need a stout nutritive grain, on clay soils, for mixture with horse meat (for which purpose it was cultivated in Italy so early as the time of Columella, under the name of *hordeum cantherinum*), or for fattening pigs or bullocks, the winter barley is well adapted, on account of its hardihood, ample produce, and highly nutritive quality. Its most esteemed property, however, especially in the south, is, perhaps, its adaptation for green meat, as sheep-feed, in which use certain peculiarities are to be attended to. I have not, in the south of England, where alone I have tried it, found it thrive, if sown earlier than mid-September. If sown sooner, it gets so forward as to be destroyed by frost. At no time during the winter does it present a close or heavy burden of green meat on the ground, like the dense herbage of rye or wheat. So soon as the plant acquires four leaves, one or two of them decay, and are continually replaced by as many others. The economical use of it in that stage of growth, therefore, is, to run your sheep and lambs over it four, five, or six times in the winter: it agrees peculiarly well with them, never griping or scouring them, as rye does. Treading does not hurt it, even on a wet clay; it succeeds on the London blue clays, and on the blue lias clays of Somersetshire; and the sheep, at each feeding, consume only that which within another fortnight would perish of itself. No accumulation of food is acquired by sparing it, nor is the power of producing a full grain crop

impaired or exhausted by the frequent winter feedings, if not repeated beyond the time when it shows a disposition to spindle. When it at length runs, in spring, if the soil is good and well manured, it rises, of the thickness of a swan's quill, to the height of 3 ft. or more, and has a very broad and fleshy flag, and a great deal of rich nutritious food, to be cut green for the stable; and it happily supplies the interval, for that purpose, between rye and wheat, or winter vetches. If sown in autumn, its grain ripens early in summer: it possesses this peculiarity, that a large, and apparently well-ripened crop is occasionally found to be destitute of vegetative power (at least, in the south of England), so that any sample grown for seed, or bought for seed, ought to be proved in a hot-bed before sowing, in order to determine whether it is fit for that purpose, or only for the pigs; and old seed habitually fails. I am, Sir, yours, &c. — *Causidicus. Dec. 1831.*

A Machine for preparing Flax and Hemp, by a new and improved Process, for manufacturing into Canvass, Cordage, &c. — Such a machine is spoken of in a letter signed L., 5. University Street, Fitzroy Square, which appeared in the *Times* newspaper, June 23. 1831. Can you, or any of your readers, inform me where it is to be had, whether its advantages are really such as that writer describes, and what is the cost of the machine? The advantages stated by L. to be derivable from its use are as follow: — 1. A saving of more than one third in manual labour, and in the purchase of the utensils and machines requisite for preparing flax and hemp for the spinner, by the operation of steeping; 2. An increase of one twentieth in the quantity as well as quality of the long fibrous threads called *horle*; 3. A diminution in the quantity of the tow, which is so superior in quality as to be capable of producing the finest cloth; 4. An increase of one twelfth in the strength of the thread, and, consequently, of all sail-cloth and cordage for the navy made from it: this is proved by the thread prepared by the machine being submitted to the test of the dynamometer; 5. The fitness of the boon (?) [husky matter] for several purposes, particularly in the manufacture of paper, containing its own size, which yields to none in beauty, texture, durability, and whiteness; 6. An increase in the value of land wherever hemp or flax are cultivated, by reason of the increased value of the produce; and, lastly, The cessation of the importation of these articles from abroad, which annually draw such immense sums from this country.

I have been requested by a correspondent in Jamaica to procure information respecting this machine for him; and as general, not partial, utility is my object, it will be best attained by acquiring it through your Magazine. — *William Hamilton. Oxford Place, Plymouth, Oct. 20. 1831.*

On enquiring at 5. University Street, we find, that the machine in question was a considerable improvement on that of Bundy (*Encyc. of Agr.* 2d edit. p. 916. fig. 987.). The inventor, a Mr. Sewicrop, has gone to Paris; but as there is a workman in London who can make the machine, the invention will not be lost; and our correspondent, or others concerned, may apply at Weir's manufactory, Oxford Street, where such information as has transpired will be obtained. — *Cond.*

ART. VIII. *Cottages and Cottage Gardens, Workhouse Gardens, and Gardens of Prisons and Lunatic Asylums.*

THE notices which we purpose giving under this head, from time to time, will be chiefly confined to recording the progress made in these departments of gardening in different parts of the country. It gives us much pleasure to observe that the great benefits which arise from adding gardens to labourers' cottages are every year more and more felt all over the country. We had many proofs of this in our late tour, both in England and in Scotland; and most sincerely do we wish that government

would pass a law to oblige all builders of cottages unalienably to attach a certain quantity of land to each as a garden, as suggested Vol. VII. p. 410. A bill has been lately (December, 1831) brought into Parliament, which proposes to oblige parishes to provide gardens for all their cottage dwellings; but the practicability of this, on the plan proposed in the bill, appears to us very doubtful. (See our observations on this subject, Vol. V. p. 712.) We prefer, as an artificial and temporary measure, some plan by which abundance of labour may be created in every part of the country. We have suggested for this purpose the reforming of the public roads all over the island, under the direction of district engineers, the expense to be paid out of the general taxes. (See our letter on the subject in the *Morning Chronicle* of Dec. 31. 1831.)

We have strongly recommended workhouse gardens (Vol. V. p. 714.) for the aged and infirm poor; and we had the pleasure of seeing at Coventry (May 6. 1831) our ideas in great part carried into effect. The three parishes which compose the town of Coventry are under one system of management as far as it respects the poor; and an old monastery and its extensive garden have been turned into a lodging and working-place. The garden is cultivated entirely by the inmates, and chiefly the old men, as the women are supplied with in-door work, and there is a schoolmaster for teaching the children to read, write, and count. It was observed to us, by Mrs. Mercer, the highly respectable matron, who has the entire management of the establishment, under the direction of a committee, that all the old men who were able to work, however little, took great pleasure in being employed in the garden, and she only regretted that there was not more ground. Mrs. Mercer is very fond of horticulture, and directs the cultivation of the garden under her care most judiciously. It was in the very best order, and without a single weed. She has a border devoted to flowers, and, as it does not contain many sorts, we venture to call on our friends in her neighbourhood, Mr. Brown, Mr. Knox, and Mr. Oliver, to send her a few plants and seeds, and a few cuttings and suckers of shrubs and roses.

We are persuaded that it would be a great improvement in the management of the workhouse poor of London, and of other large towns, to have workhouses in the country, in the midst of large gardens, for their aged and infirm inmates, who might then be usefully and agreeably employed in the gardens in raising part of their own food. The idea of so many aged persons spending their last days in workhouses, is indeed deplorable; but it seems to be inseparable from the wretched state of society in this country. In the great Marylebone workhouse*, which has a front that, for length, and the size and number of the windows, might be compared to a Russian palace (and indeed it closely resembles that of General Apraxin, at Moscow, of which we possess an elevation), there are constantly from 80 to 120 very old men and women, who are led or carried out, one by

* We visited this immense establishment on the 28th of December last. It covers several acres, and consists of several courts, surrounded by buildings, or by high walls, including a chapel, an infirmary, a girls' school and a boys' school, and a prison. The infirmary fronts the New Road, and has a simple unbroken elevation, with large windows on the first floor; producing, on the whole, considerable grandeur of effect. The total number of inmates is about 1440 grown-up persons, and about 300 children. Of the grown-up persons at least 500, we were told, are able-bodied men, who cannot get work; above 100 are old men and women, unfit for any kind of employment, some of them bed-ridden. Between 200 and 300 are in the infirmary. The whole appeared to us as well managed as an institution of the kind possibly can be.

one, every morning, and set down on a bench, under a shed, or, when the weather is fine, in the sun, where they remain, almost in a state of torpor, being unable to help themselves, and having no one to attend to them, till they are led or carried, one by one, back again, at the time appointed for their next meal. What a picture of human desolation! If, instead of being placed upon benches, with nothing to gaze at but a brick wall, these persons were led into a garden, where they could see numbers of their fellow inmates at work, breathe the fresh air, see and smell the flowers, and hear the birds and other rural sounds, their miserable lot would have some little alleviation. A number of them could perhaps assist in some of the lighter garden operations; the most infirm could scare away birds, or prepare gooseberries, and shell legumes for the kitchen. This might enable them to measure their time as it passes, and would afford some kind of amusement to divert their minds from incessantly dwelling on their own forlorn and hopeless situation. Is it too much to say that something would be gained for the happiness of the human kind, if all men were agreed that, wherever there was a habitation, whether for an individual family, or for a number of persons, strangers to each other, such as hospitals, workhouses, prisons, asylums, infirmaries, and even barracks, there should be a garden. In our opinion, a dwelling without a garden ought not to exist.

At Aylesbury, Chester, Lancaster, and some other places, we found gardens of more or less extent attached to the prisons, in which the prisoners were allowed to work, in some cases as a recreation, and in others as labourers for the governor of the prison. We found the gardens in excellent order, with abundant crops of useful vegetables, or richly ornamented with flowers, and we were informed that the prisoners were much humanised by their culture. We have no doubt that, as a means of prison education, gardens might be turned to good account by humane and pains-taking governors and gaolers; and we could wish they were appended to every gaol and penitentiary.

To the large County Lunatic Asylum, near Lancaster, which we visited on the 9th of July, 1831, there is a garden of several acres attached, and we were informed that many of the inmates took delight, some in cultivating particular spots as their own gardens, which were pointed out to us, and others in assisting in the general operations of the garden. In the private Lunatic Asylum of Spring Vale, near Stone, so admirably managed by Mr. Bakewell, the operations of gardening and farming are made to serve as exercises and recreations for several of the invalids. From what we were informed by Mr. Bakewell, we are led to consider a garden as even a more important appendage to an establishment of this kind than it is to a workhouse or a prison.

With respect to cottages, we are extremely anxious to bring into practical use the two inventions of Mr. Frost before mentioned (p. 60.), by which fire-proof cottages, of endless duration, and warmer than those of either brick or wood, might be constructed, we believe, at the ordinary expense. We wish much that some individual, who has a few hundred pounds to spare, and a suitable situation for a few cottages, would take Mr. Frost by the hand, and show what can be done by his inventions. One great advantage of his cement and tubes is, that they are of easy transport; and we are persuaded that, if their application were once fairly understood they would be much in demand for the West Indies, North America, and Australia. These inventions are even still better adapted for town-houses than for cottages, the former being so much more liable to fire. The great impediment is, that this mode of building is at variance with the interest of timber merchants, carpenters, bricklayers, plasterers, paviors, and slaters: no small proof of the importance of the invention.

The Letting of Land to Labourers in Suffolk and in Cambridgeshire.—Sir, The remarks in your last Number (Vol. VII. p. 706—709.) on cottage gardens and gardening have considerably interested me; and, had I leisure, I

would reply to those by Charles Laurence (p. 707—709.), whose experience has led him to very different conclusions from those to which my practice has led me, and who seems to have been singularly unfortunate in having only encountered labourers of the dullest capacity. Having, however, recorded my own conclusions in a pamphlet*, I shall not here repeat them, but submit a supplementary instance or two of the extending application of the system of letting land to labourers.

In Vol. VII. p. 223. you have already recorded, that, since the publication of the *Peasant's Voice*, the forty half-acres stated in that pamphlet to have been occupied, for the eight years preceding, by forty labourers, in this parish, were, in the close of 1830, doubled, so as to allow each labourer an acre; thus clearly proving that the landlord, our vicar, had seen no cause to be dissatisfied with the system, but far otherwise. From the date of that event to the present time, various gratifying circumstances, some near, some distant, connected with this subject, have become known to me; and of these I shall acquaint you with two, even should they, as I am personally connected with both of them, criminate me of egotism.

On the 17th of August, 1831, I received a letter from the Rev. E. Jones of Pakenham, a village six miles from Bury St. Edmunds, on its Norwich side, informing me that nearly 50 acres are let to the labourers of his parish (one acre of arable land is the largest quantity, then half acres, and 4 or 5 quarter acres or roods, and 4 allotments for a cow): that all the occupiers are highly pleased and grateful for them: and he adds, "There are many fresh applicants for land, whose wants I am afraid cannot at present be satisfied." Mr. Jones having learned that the labourers in my parish occupied an acre each, requested me to communicate the mode of cultivation here practised, for the benefit of the labourers in his own parish.

On the 20th of October, 1831, I received a letter from the Rev. Edgar Rust of Drinkstone, a village on the Ipswich side of Bury St. Edmunds, and near Woolpit, informing me that he is the principal trustee of some charity land; that he was anxious the poor should have the full benefit arising therefrom; and that he wished for my personal assistance in apportioning some land to agricultural labourers, and offering to recompense me for my time and expenses. I determined to wait on Mr. Rust; and, in passing through Bury St. Edmunds, replied there to Mr. Jones's letter, informing him that I was on my way to Drinkstone. My ride from Bury to Woolpit, which is very near Drinkstone, was short, but very pleasant; the morning was fine. The corn in many places was full rowed; the rising hills and sloping vales reminded me of Surrey and Sussex, only that the hills are not so lofty; but the healthy whitethorn [hawthorn] fences and vigorous-growing trees showed that it is a far better soil. I was pleased to find all the cottage gardens that I saw in excellent order, many of them of a good size, and cottages of a comfortable appearance. At Woolpit is a large pear tree, trained to what we call a smock windmill (they are called smock windmills, to distinguish them from post-mills), which appeared to be in a very healthy condition. I was kindly received by the Rev. E. Rust; he is a benevolent man, with firmness of purpose. The population of Drinkstone is about 400 souls; and the land is about 1800 acres, 37 of which is charity land, and 8 of town land. The charity land, from the donor leaving it to supply the poor with bread, has received the name of *Bread Closes*; but it has been let to the farmers for a number of years, who have of late years expended the greater part of the rent in binding out apprentices. Mr. Rust is desirous that the labourers should each of them occupy an acre of it, at an easy rent. This a part of the farmers are against, and have

* "A Peasant's Voice to Landowners." 1830. 8vo, pp. 76. 2s. 6d. W. H. Smith, Cambridge; John Richardson, London.

threatened to hire labourers from other parishes, and stop the labourers' head-money. The price of labour at Drinkstone, for a married man, is 9s. per week: the rest, where there is a family, is made up from the poor's rate, and receives the name of head-money. These threats have had a tendency to deter some of the labourers from becoming occupiers. The land is staked out, and some of it, perhaps the greater portion, is let. When the labourers are convinced they have a permanent interest in the land, and have got over their fears, it will all be let. Mr. Rust is not only anxious that the labourers should possess land, but that they should be assisted in erecting cottages upon them, free from manorial dues. The rent arising from the land the labourers occupy, being left for their benefit, may judiciously be expended in erecting cottages. The land is, the greater part of it, good. Mr. Rust is fully disposed to do all the good he can, and I have no doubt he will ultimately succeed to the utmost of his sanguine expectation.

I had not been an hour at Drinkstone before the Rev. Mr. Jones arrived (to my surprise) from Pakenham. He went with us to examine the land; and we conversed with several labourers that we found working in the field, to whom I was introduced as a friend to, and one that had had much practice in, cottage allotments. One man has been in possession, for some time, of about two acres, near his cottage; it was very foul when he took it; he was getting in his wheat. I could not perceive either a biennial or perennial weed in his allotment: he has a large family; is as cheerful as a black-cap; and does not receive head-money. Nearly all we saw were invited to come to Mr. Rust's in the evening, where, after conversing with them, they were ordered to go and make themselves comfortable in the kitchen. Mr. Jones requested that I would spend a day or two with him, and see what had been done at Pakenham. He came over for me the next day to Mr. Rust's. I shall ever entertain a grateful sense of Mr. Rust's and Mr. Jones's kindness to me, to merit which I had not done any thing but eat and drink; for both these gentlemen are so well acquainted with the system, and enter so heartily into it, that they stood in no need of any advice or information from me more than they had received from the *Peasant's Voice*. At Pakenham the greater part of the tenants occupy acres; their wheat crops were up, and looked beautiful; most of their land is near their cottages. Mr. Jones went with me to all the allotments, introduced me to a number of the tenants, to whom he said, they might thank me for the land they occupied; for, if he had not read my book, he should not have thought of letting them have it. There are four allotments for cows on land which, before it was drained, was but of little value; a river runs through it, and it is drained by a tunnel made under the river, and a dike cut 3 or 4 ft. below the bottom of the river, at some little distance from it. Here my plan is realised; and from the information I gained from the tenants (the wife of one of whom said they had had 40 sacks of potatoes from a quarter of an acre), and from nine years' observation in my own parish, I am fully confident that it will realise all I have ever said in favour of the system. I feel pleasure in adding, that, at Pakenham, the labourers are not pestered with a long list of rules and regulations, or of conditions: they pay their rent quarterly; in every other respect they are treated the same as a person occupying 100 acres. At Barton, also near Bury St. Edmunds, I hear it is adopted. Mr. Jones read me a letter from a gentleman who is travelling the country, who informs him, that, wherever the plan has been tried, it has fully answered the end proposed. I left Suffolk, highly gratified in my personal feelings, and not less so at what is doing and has been done for the labourers in the above-mentioned parishes. I wish all those who possess the means would imitate the praiseworthy example of the above-named gentlemen. By so doing they would not only raise the

labourer in his own estimation, and enable him to support his family in comfort, but the "pressing temptation to crime would be removed; a moral feeling would be created, which exercises a more efficient control over the actions and passions of men, than all the terrors of the most vindictive code of criminal law. If he [the labourer] be not so cringing and servile to the farmer in outward appearance, neither will he conceal the dark malignant purpose of revenge within. If his sturdy independence be disagreeable to the farmer, still more disagreeable ought that mendicant disposition to be which shakes the security of his possessions, which haunts his hours of rest with terror, and gives the gathered stores of his granaries to the midnight flames." This quotation is from the address of the Sussex Association to the Agricultural Labourers. I am, Sir, yours, &c. — *J. Denson, sen. Waterbeach, near Cambridge, Dec. 20. 1831.*

ART. IX. *Metropolitan Nurseries.*

UNDER this title we intend in future to include such notices as we may give from time to time of the nurseries and florists' gardens within 20 miles of London. The notices which we are most desirous of giving are those which respect the introduction of new plants, and the flowering or fruiting of such as have been lately introduced. We are more particularly anxious, now that the Horticultural Society has published a second edition of its Catalogue, to record the names of those nurserymen who may plant collections of stock fruit trees correctly named, according to it, for the purpose of supplying themselves with scions and cuttings for propagation. We are convinced that this is the only mode by which a nurseryman can keep his trees always true to their names; and, therefore, we are desirous not merely of naming the nursery in which this mode is adopted, but of giving lists of the kinds planted as stock. We are also desirous of noticing all the arboretums which may be planted in nurseries, with a view to showing purchasers the great variety and beauty of the trees and shrubs which will endure the open air in this country.

We feel confident that we shall render both the London nurserymen and their country correspondents an essential service by this plan, and that there can be none better for acquainting gardeners and our readers generally, with what is going on in the gardening world. The metropolitan nurserymen who plant fruticetums and arboretums may not only supply the trade in the country with plants, but we do not see why they should not also sell scions and cuttings both in the grafting and budding seasons. It is a mistake to suppose that this would lessen the demand for young plants; if that effect were a likely result, it would have taken place long ago, in consequence of the thousands of cuttings given away annually by the London Horticultural Society; but, so far from this being the case, we believe that the attention which has thus been directed to the new kinds of fruits has greatly increased the sale of fruit trees. The truth is, that, in these days, when every article of commerce is sold at the very lowest rate of profit, no private gentleman could raise fruit trees so cheaply as he can purchase them from a nurseryman. The cuttings given by horticultural societies to private gentlemen are generally grafted on trees already existing, with a view of substituting a better sort. This is a practice highly to be commended, and as it will undoubtedly continue to spread, we recommend nurserymen to assist in it, and profit from it, by offering scions for sale. They may rely on it, that the greater number of country gentlemen, even of those who are members of a horticultural

society, would rather purchase cuttings than have the trouble of applying for them, or the feeling of receiving them as a favour. Besides, nine tenths of those who would be happy to have good sorts of fruits grafted on trees of bad or indifferent kinds are not F.H.S.s, and therefore not entitled to apply to any horticultural society for scions or cuttings; and to these it would be highly acceptable to be able to purchase them from nurserymen.

Why not sell cuttings of every kind, as well as seeds, bulbs, and tubers? Depend on it, as horticultural skill increases, this will be done; and the wisest nurserymen will be those who fall into the practice, instead of ineffectually attempting to oppose it.

Requesting our readers to favour us with whatever they think will contribute to the value of this portion of our work, and also to that of the article on Provincial Nurseries, we proceed to lay before them such notices as we have received, or have ourselves had time to prepare.

Brown's Bedford Nursery, Hampstead Road. — Nov. 19. 1831. Mr. Brown, a pupil of the late Mr. Don of Forfar, occupied, for several years, the Bedford Nursery in the New Road, now no longer in existence. A few years ago, he commenced this establishment, and has built a number of very excellent green-houses and pits, and one or two forcing-houses. In a bark-stove for pines and exotics, with grapes under the rafters, he has introduced a very good method of withdrawing the vines for the purpose of wintering them. The front glass is in sashes, about 3 ft. long and 2 ft. high. The uprights which support the rafters are alternately fixed and movable; and when it is desired to take out the vines, the movable upright is knocked out, the sashes and the sill removed, and thus a space, 6 ft. 6 in. long, and 3 ft. 4 in. wide, is cleared, through which each particular vine may be withdrawn. The advantage of the plan is the abundance of room, by which the oldest and most rigid-stemmed vines may be taken out with ease, and without injury. Mr. Brown has built himself an excellent house, with a detached seed-shop. His business is chiefly local; and, being a man of considerable taste, he is much employed in laying out and keeping in order suburban gardens. In his seed-shop we observed a few gardening and botanical books for sale, which we think highly commendable.

The Maryland Point Nursery, Stratford, Essex, lately occupied by Mr. Garraway, has recently been taken possession of by our friend and correspondent Mr. Thomas Corbett, who is devoted to botany and gardening, and, we have no doubt, will raise the character of this or any other establishment which he may take in hand. As soon as we can find leisure, we shall call and report on it.

Epsom Nursery. — New or rare plants which have flowered last year in the nursery of Messrs. Young, at Epsom.

I adopt Professor Lindley's arrangement of the natural orders, admirably illustrated in his *Introduction to the Natural System of Botany*; a work which will amply repay the careful perusal and attentive study of every gardener.

Hybrid plants will henceforth stand at the end of the systematic list, in order to point out the propriety of distinguishing between legitimate species and "artificially created forms." I retain, however, the Latin specific appellations for the present, as the most efficient means for distinguishing the particular kinds, or until a preferable mode may be proposed. See Lindley's observations, in *Botanical Register*, t. 1387 [For the amount of the observations alluded to, see p. 12.]

DICOTYLEDONOUS.

Umbelliferae Juss., Lindl. *Introd.* p. 4. *Trachymène* *Rudg. linearis* *Spreng.* A neat green-house shrub, with white flowers in August and September; strikes readily in a cold frame.

Papaveraceæ Juss., Lindl. Int. p. 8. *Papàver Tourn.* pyrenæicum Willd. In foliage resembling the equally elegant *P. alpinum* Lin., but more robust. The flowers are golden yellow, produced from May to October. Dry situation, or rockwork; seeds. The root-stock will rarely admit of division without injury.

Cruciferae Juss., Lindl. Int. p. 14. Trib. 2. *Alyssinæ* Dec. *Anodonteæ* (sect. of *Alyssum*) Dec. *tortuosa* Ledeb.? *A. obovata* Ledeb.? Charming little rock plant, with yellow flowers all summer.—*Dràba* Dec. *repens* Bieb. A stoloniferous yellow-flowered species.—Tribe 12. *Brassicæ* Dec. *Sinàpis Tourn.* frutescens Ait., Hook. Bot. Misc. vol. i. t. 28. An interesting shrubby species of *Sinàpis*? with pale yellow flowers in July and August. Frame.

Fumariaceæ Dec., Lindl. Int. p. 18. *Corydalis* Dec. **bibracteata* Haw. ined. Closely affined to *C. bulbosa* Dec.

Magnoliaceæ Dec., Lindl. Int. p. 24. *Talaïma* Juss. *Candollei* Blume. This noble plant, a congener of the beautiful *Magnolia*, flowered, for the second time (I believe) in this country, in July last. The odours of one blossom suffused a large hot-house with a fragrance the most delicious imaginable. The flower began to develop about 9 o'clock in the morning, by 11 was fully expanded, continuing till noon, when it began to close and to decrease in fragrance. By 4 in the afternoon it was finally closed, and not the least fragrance remained. The flower is straw-coloured, of a rich yellow on the inside, about the size of *Magnolia pumila*. It thrives vigorously in loam and peat plentifully supplied with water; is propagated by ripened cuttings plunged in tan, or engrafted on the *Magnolia obovata* Thunb., or perhaps some of the stronger-growing kinds might be preferable.

Berberideæ Vent., Lindl. Int. p. 30. *Berberis* L. *dulcis* Sweet, B. F. G. t. 100., *B. empetrifolia* Lam. Exceedingly rare species; quite hardy.

Malvaceæ Juss., Lindl. Int. p. 33. *Málva* L. *purpurata* Lindl., Bot. Reg. t. 1362., *M. miniata* Cav., Sweet's B. F. G. t. 120. Beautiful herbaceous plants. Frame.—*Hibiscus* L. *Lindleyi* Wallich, Bot. Reg. t. 1395. Admirably adapted for planting in the open border in the summer months, where it grew to the height of 4 ft.; and produced its splendid purple blossoms in August and September. Stove in winter.

Sterculiaceæ Vent., Lindl. Int. p. 36. *Hermannia* L. *glandulosa* Link? An elegant yellow-flowered species, flowering in the open border from June to October.

Saxifragæ Dec. and Duby, Lindl. Int. p. 49. *Saxifraga* L. *altifida* Haw. A rare species, resembling in habit *S. granulata* L.; but the roots are not granulated.—*S. tricuspida* Retz. A white-flowered species, not a coordinate of *S. aizoides* Sm., as was doubtfully supposed by Mr. Haworth when he framed his genus *Leptæsea* from them.

Cactææ Dec., Lindl. Int. p. 54. *Pereskia* Plum. *Blèo* H. B. et Kunth. An elegant and rare ally of the common *P. aculeata* Mill.

Onagrariæ Juss., Lindl. Int. p. 56. *Gaúra* L. *angustifolia* Mich. Suffruticose. *G. tripétala* Cav. Pretty plants with fragrant white or pink flowers. Frame.—*Ænothèra* L. *anisoloba* Sweet, B. F. G. t. 105. A beautiful erect species, from 2 to 3 ft. high, with flowers resembling *Æ. taraxacifolia* Sweet. Frame; easily increased by cuttings of the root.

Salicariæ Juss., Lindl. Int. p. 59. *Cùphea* Jacq. *Llavea*, *Llave* et Lexarc. Bot. Reg. t. 1386. It is a lovely border shrub for the summer months, enlivened with beautiful crimson blossoms from July to October. Cuttings; frame. It is erroneously called a herbaceous plant in the work above quoted.—*G. Penny*, A.L.S. (*heretofore Alpha*).

(To be concluded in next Number.)

ART. X. *Provincial Nurseries.*

It is our intention in future to have a standing article on this subject, at least till we can notice all the country nurseries of Great Britain and Ireland. We shall commence with a few particulars of some of those which we visited during our late tour; arranging them under their respective counties, as we do the Provincial Societies, omitting all those within twenty miles of London as Metropolitan Nurseries. To complete our intention, we must request of our readers to send us accounts of all the nurseries, large or small, long established or recent, in both Great Britain and Ireland, of which statements have not already appeared in this Magazine, or of which the statements have been incorrect or incomplete up to the present time. We request —

1. The name of the place.
2. The date of the foundation of the nursery, and by whom it was founded.
3. The name of the present proprietor.
4. The extent in statute acres.
5. Whether seeds are dealt in.
6. The quantity of glass and buildings.
7. The general scope and purpose of the nursery; the articles in which it excels; those which are chiefly cultivated, and similar particulars.
8. Whether, and to what extent, the new fruits, especially pears, which have been introduced by the Horticultural Society, have been propagated.
9. Whether, and to what extent, there are stock plants of fruit trees, from which to take grafts and cuttings.
10. Whether, and to what extent, there is an arboretum; that is, specimen plants of trees and shrubs.
11. Whether seeds are grown, and what kinds chiefly.
12. Whether there is a garden library, and, if there is, the number of volumes, &c.

We have particularly to request, whatever botanic names may be made use of in giving the notices wanted, or in sending lists of rare plants in particular nurseries, either that the names made use of may be those of our *Hortus Britannicus*, or that the authorities for the names may be given after them.

Every account should be accompanied by the real name (which will be kept private, if desired) of the writer.

The good effects which we think will result from such an account of all the provincial nurseries as we contemplate are various. It will facilitate commercial exchanges among the nurserymen, both provincial and metropolitan; and it will show country gentlemen what they can get in their immediate neighbourhoods, and thus enable them to encourage local nurserymen; who, in order to preserve the patronage thus obtained, will necessarily be more anxious to procure the newest fruits, trees, and plants from the nurserymen of the metropolis. The result of the whole will be a more rapid and extended circulation of every new and valuable production and improvement in gardening, with more profit to commercial men, and less expense to purchasers. The profit will be more, because, more articles being made known to country gentlemen, and being at their hands, more will be purchased by them; and the expense to purchasers will be less, not only because a country nursery can grow articles cheaper than a metropolitan one, but because articles sent from a distant nursery have always the additional charges of package and carriage; and because a certain percentage of all plants subjected to distant carriage never fail to die.

There is a notion very general amongst country gentlemen, that every thing is got of better quality from the metropolis than it can be had from any little place in the country. If this is true in some things, it is at all events false in regard to plants; for it is obvious that any species or variety of tree is the same thing, wherever it may be grown. The individual plant may, no doubt, be stronger or weaker when obtained from one nursery than from another; but that will depend upon the soil and culture, and not on the locality; and, so far from the chance of town plants being the best, they are likely to be the worst, from the dearness of land and labour, and the temptation, in consequence, to crowd plants together. Unless, therefore, it can be shown that local nurserymen misname their plants, trees, or seeds, it must, for various reasons sufficiently obvious, be the interest of persons living in the country to purchase garden articles from their neighbours, rather than to send to a distance for them.

In short, as a general principle, it is the interest of landed proprietors to encourage local tradesmen and local merit of every description. It is only in an early stage of the improvement of a country, that wealth and talents are necessarily concentrated in the capital. As improvement becomes general, trades, manufactures, and skill of every kind, become comparatively equalised over a whole state. We recommend, therefore, not merely the employment of local labourers and tradesmen, but of artists and scientific men; provided always that these scientific men and artists have travelled, and spent some time in the study of their profession or art in some capital town. Reading and extensive travel will, indeed, almost supersede the latter means of improvement in engineers, architects, and painters; and, if gardeners could afford it, it would have the same effect on them. As they generally cannot, however, the next resource is their serving as journeymen in some garden in the neighbourhood of the metropolis; within 20 miles of which are concentrated more species of plants, and a greater variety of other garden productions, and modes of gardening, and more gardeners of every description, than are to be found in any other circuit of equal extent in any country. While we recommend gentlemen, therefore, to purchase their plants, trees, and seeds, as much as they can, from local nurserymen, we would not recommend them to employ local gardeners who have never been from home.

But the metropolitan nurserymen will ask how this doctrine is to be reconciled with their prosperity. We answer, that whatever contributes to the prosperity of country nurserymen will produce a corresponding effect upon those of the metropolis and other capital cities; since the former must necessarily depend on the latter for their wholesale purchases, of seeds more especially, and of all new things. The London and Edinburgh nursery and seedsmen, therefore, must, in conformity with the natural progress of things, prepare themselves for living by the country nurserymen as wholesale customers, and depending upon their immediate neighbourhoods for their retail business.

In the present Number, we can only spare room to notice such of the nurseries as have made good their promises to furnish us with lists.

ENGLAND.

CHESHIRE.

The Bache Pool Nursery, near Chester, Messrs. F. and J. Dickson, containing upwards of 50 acres, was commenced in 1816, by the present occupiers. It was formed by breaking up some pasture fields of sandy soil, and laying them out in parallel strips, and small squares, sheltered by privet, thorn, hornbeam, yew, and holly hedges. Every description of hardy article is cultivated on an extensive scale. There are some green-

houses, and a considerable extent of pits ; but house plants are considered as only secondary objects. Mr. Francis Dickson is a most enthusiastic lover of plants, and a good practical botanist ; he has accordingly collected together an excellent assortment of herbaceous plants, including a great many rare and good articles, a number of them not to be found any where else. The following select list has been sent us, at our request. Before introducing it, we shall only mention, that when looking over the nursery on the 4th of July last, we were much struck with the largeness of the stock of some of the more rare and difficultly-managed species.

- Aconitum volubile*,
Aconitum patens,
ranunculoides,
narcissiflora,
thalictroides,
 pleno [*Thalictrum aconitoides* and v. pl.]
 palmata,
 vernalis,
 Halleri,
 baldensis,
 ochotensis,
 virginica,
tulipiflora,
Anthrinum pilosum [*Linaria pilosa*],
trionithophorum [*Linaria trionithophora*],
Arum triphyllum,
 tenuifolium,
Aquilegia canadensis,
 can. pumila,
 purpurea,
 alpina,
 alpina var.
 atropurpurea,
 glandulosa,
 glandulosa var.
 atropurpurea,
Aster alpinus,
 alp. albus,
 major,
 dichotomus,
 dich. albus,
 gravolens,
 tataricus,
Arnica montana,
Asclepias tuberosa,
 pulchra,
 nivea,
Astragalus uralensis,
 alopecuroides,
 monspessulanus,
 vintneus,
Onobrychis,
Apocynum venetum,
 hypericifolium,
 androsæmifolium,
 rubrum,
Anthyllis montana,
Adiantum pedatum,
Androsace Chamajascæ,
 lactea,
 villosa,
 lactiflora,
Ajuga pyramidalis,
Amaryllis lutea,
Atamasco,
Ammobium alatum,
Alëtris farinosa,
Andryata lanata,
Antennaria triplinervis,
Apargia alpina,
 dubia,
Arnica montana,
Arenaria bifolia [?],
 grandiflora,
Arctia alpina,
Vitalbana,
Aphyllanthes monspeliensis,
Arethusa bulbosa,
Adenophora coronopifolia,
Arechusa paniculata,
Blëtia florida,
Botrychium virginicum,
Campánula pólla,
 punctata,
 stylisa,
 lactiflora,
 filifolia,
 thyrsoidea,
 barbata,
 peregrina,
 infundibulum,
 pulcherrima,
 versicolor grandiflora,
 aggregata,
 mollis,
 latifolia macrantha,
 glomerata pallida,
 rosea,
Cineraria fussilaginoides,
Cheibone obliqua alba [glabra],
 nemorosa,
 Cimicifuga palmata,
Convallaria japonica [*Ophiopogon japonicus*],
 racemosa [*Smilacina racemosa*],
Calceolaria Fothergillii,
Calophyllum thalictroides [?],
 Isopyrum],
Cistus Tuberaria [*Helianthemum Tuberaria*],
Claytonia grandiflora,
 virginica,
 caroliniana,
Chrysanthemum Achillææ,
 arcticum,
Cornus canadensis,
 succica,
Cristaria coccinea,
Coronilla coronata [montana],
 L.],
 ibérica,
 minima,
Cortusa Matthioli,
Cotyledon lutea,
Cypripedium Calceolus,
 arietinum,
 spectabile,
 pubescens,
 humile,
 ventricosum,
Cumula mariana,
Cóchleum sinense,
Clématis Pallasiæ,
Dianthus barbatus pumilus,
 alpinus,
 arbuscula,
 Fischèrii,
 Balbisii,
Digitalis laciniata,
 grandiflora,
Dodecatheon Meadia,
 Me. flaba,
 elegans,
 gigantea,
Draba aizoides,
Draba androsæica,
 Aizoon,
Dracoccephalum botryoides,
grandiflorum [*D. altaianse*],
 arguense,
 Diphyllia cyndsa,
Dentaria diphylla,
Dryas octopetala,
 intermedia,
 Drummondii,
Echinops dahuricus,
Epilobium Dodonæi,
 latifolium,
Delphinium dietyocarpum,
 Barlowi,
 sinense album,
 pallidum,
 plenum,
 cheilanthum,
Epipactis ensifolia,
Erythraea aggregata,
Erythronium americanum,
Erythronia conspicua,
Eriophyllum caespitosum,
Eschscholtzia californica,
Fumaria nobilis [*Corydalis nobilis*],
 canadensis [*Dielytra canadensis*],
 Cucullaria [*Dielytra Cucullaria*],
 cava,
 cava alba [*Corydalis tuberosa albiflora*],
Galax aphylla,
Galium græcum [*Asperula arcaeiensis*],
Gaillardia bicolor,
 bicolor var.
 aristata,
Gentiana gelida,
 alpina,
 verna,
 bavaria,
Pneumonanthe,
 pumila,
 guttata,
 incarnata,
 ochroleuca,
 verna pallida,
 verna pallida alba,
 asclepiadæa flaba,
Geranium argenteum,
 Wallichianum,
 sanguineum coelestem,
Gerardia quercifolia,
Gerardia virginica [?],
Gerbèria crenata,
Gèum sanguineum,
 potentilloides [*Colària potentilloides*],
 Pèckii [*Sieversia Pèckii*],
 montanum [*S. montana*],
Gladolus pittacinus,
 cardinalis,
 blandus,
 byzantinus,
Globularia vulgaris,

- Globulària cordifòlia.
 nudicaulis.
 Glycine A'pios [A'pios tube-
 røsa].
 Gymnàd'nia conòpsea.
 Gyps'phila rèpens.
 Gonolòbus macrophýllus.
 hirsùtus.
Helènum californicum.
 Habrànthus robùstus.
 Hedýsarum obscurum.
 røseum.
 alpinum.
 canadènze.
 acuminàtum.
 Helònias bullàta.
 dioica.
 asphodeloides [Xerophýl-
 lum asphodeloides].
 Hermínium monòrchis.
 Hippocrèpis balcàrica.
 grandiflora.
 Hustònia cerùlea.
 purpùrea.
 serpyllifolia.
 Heuchèra americàna.
 Hyacynthus botryoides var.
 àlba.
 amethýstinus.
 Hunnemànnia fumaricifolia.
 Hyoseyamus orientàlis.
 Hypòxis erècta.
 Iris hungàrica.
 vèrna.
 Ixia Bulbocòddium [Tricho-
 nema Bulbocòddium].
 Jeffersonia diphýlla.
 Justicia americàna.
 Láthyrus latifolius àlbus.
 californicus.
 venòsus.
 incùrvus.
 Leucòjum vèrnum.
 autumàle [A'cis autum-
 nàlis].
 Liàtris èlegans.
 Lilium canadènze.
 philadèlphicum.
 pennsylvànicum.
 japonicum.
 longiflorum.
 spectàbile.
 pyrenàicum.
 monadèlphum.
 Lophola àurea.
 Lubinia atropurpùrea.
 Lupinus polyphýllus.
 poly. àlbus.
 littoràlis.
 tomentòsus.
 ornàtus.
 plumòsus.
 lépidus.
 Lýchnis fulgens.
 chalcedònica *double white*.
 Lobèlia cardinàlis.
 speciosa.
 spléndens.
 Malàxia iliiifolia.
 Matricària grandiflora [Pyrè-
 thrum inodòrum flòribus
 plènis].
 Melissa pyrenàica.
 Mitèlla diphýlla.
 nuda.
 Melànthium virginicum.
 Michauxia decàndra.
 Monàrda Russelliana.
 Myosòtis suavèolens.
 Neòttia cèrnea.
 Nuttállia digitàta.
 pedàta.
 Ænothèra albicaulis.
 taraxaciifolia.
 Onòsma arenàrium.
 taùricum.
 Onòsma tinetòrium.
 echioides.
 Ophiopogon spicàtus.
 japonicus.
 O'robis Fischèri.
 hirsùtus.
 versicolor.
 Pædònia hùmilis.
 hùmilis cæ'sia.
 albiflora Whitlèyi.
 tatàrica.
 càndida.
 uniflora.
 fràgrans.
 Humei.
 vestàlis.
 officinàlis àlbicans.
 blànda.
 Sabin.
 atròrubens.
 rùbra.
 røsea.
 carnescens.
 peregrina Grevillèi.
 compàcta.
 byzantina.
 paradòxa fimbriàta.
 simpliciflora.
 tenuifolia.
 anomala.
 decora elàtiòr.
 Pallàsi.
 arietina Andersòni.
 oxoniènsis.
 mólilis.
 coràllina.
 dàndrica [triternàta].
 Rússi.
 pùbens.
 villosa.
 multipétala.
 præcox.
 Paucràtium maritimum [il-
 lýricum].
 Papàver nudicaule.
 nu. luteum.
 coccineum.
 alpinum.
 cruceum.
 coccineum.
 Pachysàndra procumbens.
 Pàris quadrifolia.
 Parnassia caroliniana.
 Pentstèmon pubescens.
 campanulàtus.
 ca. rùber.
 levigàtus.
 digitàlis.
 røseus.
 atropurpùreus.
 pulchèllus.
 diffusus.
 ovàtus.
 angustifolius.
 Richardsòni.
 Scouleri.
 speciosus.
 procèrus.
 glàucus.
 gracilis.
 glandulòsus.
 acuminàtus.
 venùstus.
 Colvilli.
 atròrubens.
 Pànax quinquefolia.
 Phlòx pyramidàlis rùbra.
 pilòsa.
 amœ'na.
 caroliniana.
 fimbriàta.
 suffruticòsa.
 bimaculàta.
 pendulina.
 reflèxa.
 Phlòx reflèxa røsea.
 decussàta àlba.
 tardiflora.
 vèrna.
 oddra røsea.
 Pinguicula grandiflora.
 alpina.
 Pàrrya cheiriifolia.
 Podophýllum peltàtum.
 Potentilla spléndens.
 Clusii.
 pedàta.
 Russelliana.
 Hopwoodiana.
 Mackayana.
 Sibbaldia.
 réptans plèna [? Tormen-
 tilla réptans plena].
 Pòthos fœ'tida.
 Pogònia ophioglossoides.
 Primula cortusoides.
 longifolia.
 helvética.
 villosa.
 nivàlis.
 scòtica.
 integrifolia.
 minima.
 ciliàta.
 Pallàsi.
 hirsuta.
 Pulmonària maritima.
 deprecàta. [?]
 Pýrola rotundifolia.
 minor.
 asarifolia.
 Ranunculus Thòra.
 alpèstris.
 parnassicifolius.
 Ficària àlba.
 pedàtus.
 Rhèxia mariàna.
 virginica.
 ciliàta.
 Rùbus àrcticus.
 saxàtilis.
 Sarracènia purpùrea.
 flava.
 Satýrium rèpens.
 Saxifraga oppositifolia.
 oppositifolia pàllida.
 refusa.
 cristàta.
 dàndrica.
 Scabiosa Webbiana [Astero-
 cèphalus Webbianus].
 Seràpias latifolia [Epipàctis
 latifolia].
 Sibbaldia procumbens.
 Sibthòrpià europæ'a.
 Sida malvæflora.
 Silène pennsylvànica.
 règia.
 incarnàta.
 fruticòsa.
 compàcta.
 Smilacina umbellàta.
 boreàlis.
 Soldanèlla Clusii.
 alpina.
 alpina var.
 montàna.
 montàna var.
 minima.
 cristàta.
 Spigèlia marilandica.
 Spiræ'a trifoliàta. [Gillènia tri-
 foliàta.]
 Stachys còrsica.
 còr. røsea.
 Stèvia violæcea.
 purpùrea.
 Stréptopus røseus.
 Sàlvia nubicola.
 rùbra.

Sanseviëra cærnea.	<i>Nola lanceolata.</i>	<i>Calceolaria ferruginea.</i>
<i>Tagetes florida.</i>	pennsylvànica.	purpurea.
lúcida.	flabellifolia.	picta.
<i>Taxánthema speciosum.</i>	blánda.	polifolia.
flexuosa.	reniformis [Eruption reni-	adscéndens.
globularisefolia.	forme].	stricta.
<i>Tigridia Pavónia lutea.</i>	sagittata.	Gilliana.
couchiflora]. T.	Wedelia aurea.	insignis.
<i>Tradescantia rosea.</i>	Whitleya stramonifolia.	Herbertiana.
orientális americana.	Wullenia carinthiaca.	Cypripedium insigne.
<i>Trillium atropurpureum.</i>	Yucca filamentosa.	venustum.
grandiflorum.	fil. variegata.	Chorizema rhomboides.
cernuum.	recurvifolia.	Cypella Herberti.
sessile.	gloriosa.	Cyclamen repandum.
pictum.	albifolia.	neapolitanum.
<i>Tulipa cornuta.</i>	Zigadenus glaberrimus.	europæum odoratum.
Clusiana.	Zephyranthes rosea.	pérsicum odoratum.
oculus sdbis.	candida.	Dionæa Muscipula.
pèrsica.	grandiflora.	Ferraria undulata.
<i>Tragopogon ruber.</i>	cornuta.	Grevillea concinna.
<i>Uvularia grandiflora.</i>		Herbertia pulchella.
flava.		Nepenthes distillatoria.
sessilifolia.		Oxalis cornosa.
perfoliata.		lanata.
lanceolata.		Dépezi.
puberula.		flabellifolia.
chinensis [Disporum ful-		floribunda.
vum].		rosea.
<i>Ferbasium Myconi</i> [Ra-		<i>Primula verticillata</i> [involu-
mónda pyrenæica].		crata].
<i>Ferbaena Lambertii.</i>		Rhododendron arboreum.
<i>Ferónica multifida.</i>		arbum album.
bellidioides.		cinnamomeum.
corymbosa.		Séptas capensis.
aphylla.		Sálvia Grahami.
<i>Nola primulæfolia.</i>		Saxifraga ligulata.
palmata.		Sparaxis tricolor.
pedata.		Turnera splendens.
	GREEN-HOUSE PLANTS.	
	<i>Alstrœmeria pulchella.</i>	
	tricolor.	
	<i>Pelegrina alba.</i>	
	hirtella.	
	acutifolia.	
	psittacina.	
	<i>Andrœmeda buxifolia.</i>	
	salicifolia.	
	<i>Azalea indicæ phœnicea.</i>	
	sinensis.	
	Smithii.	
	<i>Angelonia salicariæfolia.</i>	
	<i>Besleria pulchella.</i>	
	Buonaparteæ juncea.	
	<i>Cætus Jenkinsonii.</i>	

The above selection from our very extensive catalogue contains only the more rare species, and such as are particularly worthy of cultivation for their beauty. — *Henry Turnbull. Foreman of the Bache Pool Nursery, Nov. 23. 1831.*

Messrs. F. and J. Dickson have a seed-shop in Chester, and deal extensively in seeds both wholesale and retail. They have a small garden library, and lend out the Gardener's Magazine to such of their customers as do not take it in.

LANCASHIRE.

The Nursery of Messrs. Conolly and Sons, at Lancaster, is chiefly noted for florist's flowers and of these, more especially carnations and auriculas. Of the latter they have 500 pots of the best sorts known. We found the carnations in very vigorous bloom; and were rather surprised to learn that the large wild bee, when it fixes on a flower bud, and pierces it with its proboscis for the honey at the base of the petals, adles it, and prevents its perfect expansion. Messrs. Conolly were (July 20.) laying their carnations, with pegs of the fronds of *Pteris aquilina*, and leaving every other layer without cutting off the points of the leaves, for the purpose of ascertaining whether layers with cut or those with uncut leaves rooted sooner. We found a number of new herbaceous plants, and some of the rarer shrubs; and, in two green-houses, some good pelargoniums, camellias, fuchsias, Cacti, and other articles. Mr. Conolly, at our request, gave us the following list of what he considers the very best carnations grown in Lancashire: —

Scarlet Bizarres: Wild's Perfection; Lee's Lady Nelson; Ely's Mayor of Rippon. *Pink Bizarres:* Cartwright's Rainbow; Wakefield's Paul Pry; Gregory's King Alfred. *Scarlet Flakes:* Faulkner's Salamander; Potter's Champion; Pearson's Madame Mara. *Purple Flakes:* Turner's Princess Charlotte; Leighton's Bellerophon; Hall's Major Cartwright. *Pink Flakes:* Faulkner's Eliza; Pearson's Lady Essex; Plant's Lady Hood. *Purple Picotee:* Lee's Cleopatra. *Royal Purple:* Faulkner's Earl Wilton. *Red Picotees:* Lee's Will Stukeley; Pearson's Childwell Beauty; Faulkner's Salamanca.

The Walton Nursery, near Liverpool, Messrs. Skirving and Co., was founded by the late by Mr. Bannerman, about 1810, and, on the unfortunate decease of that much-respected gentleman, it came into the possession of the present occupier. It contains fifty acres, admirably laid out, divided by main walks and alleys, and sheltered by beech, hornbeam, thorn, privet, and holly hedges, and by lines of *Sórbus híbrida* (*Pýrus pinnatífida*), *torminàlis*, &c.; trees which, unlike most others, have the habit of growing perfectly erect in the most exposed situations, and even in places where the winds blow from one quarter the greater part of the year. All hardy articles are cultivated in this nursery, and forest trees to a great extent. Seeds are dealt in, and some sorts are grown. There are two or three green-houses, and a number of pits. We refer to Vol. VII. p. 556., for what we have said, both of this nursery and that at Bache Pool. The following are the notes we took on the spot:—“ July 13. Observed a fine plant of *Escallònia rùbra*, first introduced by Mr. Shepherd, a rather tender evergreen, which flowers all the summer season; *Hibiscus líliiflórus* in the green-house, which continues beautifully in flower all the year; *Colúmnea scándens*; *Hibiscus pulchéllus*; *Corræa pulchélla*, a very large specimen; a singular speckled variety of balsam, first raised by a person in the neighbourhood; *Hunnemánna*; *Stenochilus maculátus*; *Calandrina grandiflora*; *Pergularia odoratíssima*; *Solandra grandiflora*; *Passiflora incarnata*, with large round fruit; *Cùphea Melvillii*; a new species of *Calceolaria*, from Lima, not yet flowered. *Catanánche bicolor*; *Símisia Lysimachia* (*Lubinia*) *atropurpurea*; *Alstræmèria Pelegrina*, very fine; two new spiræas; *Smilacina umbellata*, *Planera* sp. Fine georginas, the tall sorts tied to three stakes joined at top; saw one grafted by inarching. German stocks, forty-eight varieties from Holland. Rhododendrons, grown in quantities, to supply the demand in that neighbourhood for them as underwood shrubs. Messrs. Skirving and Co. grow an improved variety of Swedish turnip for seed: one of these turnips weighed 27 lbs. Roses propagated by cuttings of the root. Different species of elms and *Planera*. Fine evergreen oak from Mr. Hodgins of Wicklow. Mr. Smith, the botanic foreman, who has been some years in France, Spain, and Portugal, says he never saw any place where things grow with such luxuriance as in Hodgins's Wicklow Nursery: even cuttings of holly, a foot long “laid in by the heels,” in bundles, strike root almost immediately. Mr. Smith has tried herbaceous grafting on various things with success. Lucerne is grown here for the horses employed for the nursery, and three good cuttings of it have been obtained in one season.

The following List of a few Shrubs and Trees in the Walton Nursery was made out for us by Mr. Dall.

<i>Acer pennsylvanicum.</i>	<i>Ilex Aquifolium</i> , or holly, recúrva, baleárica, opàca, Hodgins's large green, Hodgins's long-spined, Davies's seedling light green, serratifolia, and forty other gold and silver varieties of holly.	<i>Pýrus elæagnifolia</i> , baccàta, spùria, præcox, amygdaliformis, salicifolia, and <i>Pollveria</i> [<i>Bollwylleriana</i> Dec.].
<i>Æsculus Hippocástanum</i> , gold-striped and silver-striped.	<i>Ilex Perado.</i>	<i>Quercus gramúntia</i> , Hodgins's large evergreen, and <i>Lucombe's</i> .
<i>Añus crispa.</i>	<i>Jasmlnum pubigerum.</i>	<i>Ribes coccineum</i> [? sanguineum], triste, album, and procumbens.
<i>Aràlia spinosa.</i>	<i>Laurus nobilis</i> var. marginatus, and willow-leaved.	<i>Rosa repens</i> [or ? repanda] and six choice double varieties.
<i>Aristotèlia Macqui</i> , striped.	<i>Méspilus Chamaméspilus</i> and <i>grandiflora.</i>	<i>Pýrus nivalis</i> , thorn-leaved, canadensis, híbrida, and twenty varieties.
<i>Bétula populifolia</i> , grows very large.	<i>Philadélphus grandiflorus</i> and <i>gracilis.</i>	<i>Spiræa bella</i> , nõva taúrica, alpina, trilobata, incarnata, and lobata [lobata is γ Δ].
<i>Bignònia radicans</i> major.	<i>Pópulus macrophýlla</i> , heterophýlla, and cándicans.	<i>Ulmus pèndula</i> , <i>campéstris</i> , and <i>fastigiata</i> , the Devonshire or screw elm.
<i>Cárpinus Bétulus</i> , cut-leaved variety.	<i>Planera Richárdi</i> and <i>Gmellni.</i>	
<i>Castanea vesca</i> , gold and silver striped.	<i>Cérusus pèndula</i> , a broad-leaved variety, fruiting in August.	
<i>Cýstus</i> , many good sorts, grafted as standards.		
<i>Crataegus</i> , or thorn, thirty good sorts.		
<i>Cotoneáster</i> , different sorts.		
<i>Hippophæe canadensis</i> and <i>si-birica.</i>		

The Walton Nursery Garden Library we believe to be the most extensive in the kingdom, and also the best managed. The articles of management, which are now before us, appear worthy of being taken as a model for similar institutions. A particular account is given of the origin of this library in our Vol. II. p. 246. We sincerely wish every nurseryman would imitate the conduct of the late Mr. Bannerman, according to his means and his situation, and establish a library of some sort in his seed-shop, if only of half a dozen volumes. We are sure the result would be for the benefit of nursery and seedsmen, by spreading a knowledge of, and taste for, gardening, and by increasing the obligations of gardeners to them.

WARWICKSHIRE.

The Handsworth Nursery, near Birmingham, Messrs. John Pope and Sons, has been established only a few years in its present situation ; but Mr. Luke Pope, the father of the present Mr. Pope, sen., was the founder of a nursery in the neighbourhood of Birmingham in the last century. The extent of the Handsworth Nursery is not great, but there are several acres belonging to it in other situations, where fruit and forest trees are grown extensively ; Messrs. Pope being in the habit of contracting largely for laying out grounds and planting them. There is one hot-house, several green-houses, and a number of pits. The articles grown at Handsworth are chiefly of botanical and floral interest ; and the list which we are enabled to present will show what a valuable assemblage of rare articles has here been collected. Mr. Pope's father was long famous for his tulips, and he declared on his deathbed that he had spent upwards of 3000*l.* on them. The collection is now at Handsworth, and made a very splendid display in the first and second weeks of May last : we were shown some sorts for which 50*l.* a root were given by the father of the present Mr. Pope, and others valued even now at 20*l.* a root : many of the finest sorts are beautifully drawn by Mr. L. L. Pope, for the inspection of purchasers. Mr. Pope, sen., has travelled through the greater part of the United States, and has introduced a number of American plants. Among these is *Rösa palüstris*, the flowers of which are double, and the leaves scented like those of the sweet briar. All the wild roses in America, Mr. Pope informed us, have scented leaves. Every part of this nursery is brimful of interest, from the number of its rarities ; but, instead of enumerating them, we refer to the list below, noticing only a seedling *Rösa odorata*, which flowered within three months from the time it appeared above ground, when not higher than 4 in., and with the seminal leaves still attached. The flower was odoriferous like the parent. In the hot-house there is a large cinnamon tree, and a fine specimen of *Ornithögalum caudatum*. Among the hardy shrubs, a tree pæony, received direct from China, single-flowered, and different from any pæony yet introduced. *Calceoläria Fothergillii*, kept through the winter in the open border ; a small hand-glass being first put over the plant to keep a portion of air round it, to prevent injury from damp, and over the hand-glass a quantity of moss for warmth, the whole being covered by turning a flower-pot down over it to keep out the rain and snow. *Rhododéndron arboreum* has stood several winters in a sheltered border, without any protection whatever. On the 7th of May, last year, the young shoots on the top of the plant were killed by the frost, while the young shoots on the layers, and all the old leaves on the plants, escaped unhurt. A tree pæony grafted on the root of a common pæony has always produced flowers larger than those propagated in the common way. The American ground is laid out in winding walks, in the manner of a labyrinth. For some other particulars, see Vol. VII. p. 410. The following lists being nearly a year old, Messrs. Pope could, no doubt, add to them, were they to revise them up to the present time ; but one use of our article " Provincial

Nurseries" will be, to publish, from time to time, the more remarkable articles introduced by this nursery, the Bache Pool Nursery, the Walton Nursery, the Ayr Nursery, and other provincial establishments.

List of Plants worthy of mention cultivated in the Handsworth Nursery.

- Achillea* Gerbèri.
Aconitum caruleum.
 rubellum.
 macrophyllum.
 moldavicum.
 sibiricum.
Alyssum saxatile variegatum.
 tortuosum.
 creticum.
 savranicum.
 micropetalum.
Aemone Popeana. [One of De Candolle's seven varieties of *A. alpina*.]
Anthemis maritima.
Apocynum rubrum.
Aquilegia atropurpurea elata.
 canadensis var.
A'rabis hirsuta.
 lucida variegata.
 Marshalliana.
 leptocarpa.
Arenaria balearica.
 fasciculata.
Aster alpinus major.
 cyaneus.
 Tripodium.
Adenophora reticulata.
Bletia florida.
Buphthalmum helianthoides.
 [Heliothis Pers. helianthoides Swt.]
Calceolaria arachnoidea.
Calystegia dahurica.
Campánula glomerata alba.
 gl. pallida.
 rosea.
 alba elata.
 cerulea elata.
 gummifera.
 cephalotes.
Cardamine hastulata.
Celsia sublanata.
 aredurus.
 occidentalis.
Centaurea cinerea.
Chelone major.
Clematis Pallasiæ.
 vionoides.
Coronilla candida.
 coronata [montana L.].
Corydalis tuberosa albiflora.
Cynanchum fuscatum.
 erectum.
 acutum.
Cynoglossum pictum.
Cytisus calycinus.
Delphinium intermedium flore pleno.
Dianthus collinus superbus.
 hirtus.
 punctatus.
 sicutus.
 Balbisii.
Draba androsacea.
 alpina.
Echinops exaltatus.
 humilis.
Epilobium alpestre.
Erythronium longifolium Sw.
Eupatium punctatum.
Erysimum crepidifolium.
 odoratum.
Ficaria verna alba.
Fragaria indica.
Fritillaria melægris fl. pleno.
Gaillardia aristata.
Gentiana Pneumonanthe guttata.
Geum ranunculoides.
 Quellyon.
 grandiflorum.
 altaicum.
 strictum.
Grindelia nitida.
Helianthus pubescens.
Houstonia albiflora.
Hypocricum marilandicum.
 Gebleri.
 Androsæmum persicum.
Inula alpina.
Iris halophila.
 pomeridiana.
 missouriensis.
 hexagona.
 prismatica.
 pumila lutea.
Iris ziphoides alba.
 pavonia.
Lamium album variegatum.
Lilium lanceifolium.
Linum tenuifolium.
 album.
 marginatum.
 quadrifolium.
Lobelia unidentata.
 Tapa.
 rhizophyta.
 triquetra.
 campanuloides.
 arenaria.
Lyschnis suecica.
 pyrenaica.
 chalcædonica carnea.
 alba plena.
Mitella reniformis.
 diphylla.
Monarda aristata.
 virginica.
 canadensis.
Narcissus moschatens plenus.
Nepeta citriodora.
Onosma rupestre.
 simplicissimum.
 Gmelini.
 tinctorium.
Ornithopus campestris.
Patrinia nudiuscula.
Pæonia multipetala.
 Russii.
 officinalis fol. variegatis.
Pentstemon glandulosus.
 speciosus.
 venustus.
 triphyllus.
 gracilis.
 procærus.
 glaucus.
 acuminatus.
 confertus.
Phlox acuminata alba.
 reflexa rosea.
 odorata rosea.
 Wheeleri purpurea.
 paniculata rubra.
 caroliniana nova.
 pyramidalis rubra.
 pumila.
 suffruticosa major.
 new French.
 philadelphica.
 Coldryana.
 Lyoni.
 fimbriata.
 hybrida.
 verna, or crassifolia Lod.
Phlox bimaculata.
 Ingrati's.
 marilandica.
 intermedia præcox.
 cordata.
 procumbens.
 glomerata.
 ambigua.
 Thompsoniana.
 elegans.
 formosa.
 pyramidalis elata.
 Brucei.
 acuminata major.
 Phyteuma virgatum.
Potentilla lupinoides.
 strigosa.
 sulphurea.
 pilosa.
 candicans.
 reptans flore pleno [? Tormentilla reptans flore pleno].
 mariana.
 ornithopodoides.
Primula Auricula flore luteo pleno, variegato pleno, lutea multplex, the last two raised at the Handsworth Nursery.
Prunella alba.
 vulgaris rosea.
Ranunculus Stevèni.
 tuberosus.
 creticus.
 pennsylvanicus.
 villösus.
Rudbeckia Newmanni [Centrocampa chrysomela].
 moschata.
Salix herbacea.
Salvia hematodes.
 multifida.
 Halleri.
 Lyoni.
Saxifraga Gmelini.
 Schradèri.
 spathulata.
Scabiosa dalurica.
Scrophularia trifoliata.
 mellifera.
 rivularis.
Scutellaria viscosa.
Senecio aureus.
Serrata præalta [Vernonia præalta].
 xeranthemoides.
 alata.
Silene saxatilis.
 noctiflora.
 paradoxa.
 Stevèni.
 tatarica.
 pubescens.
 Statico, Pope's hybrid, or Popeiana.
Thalictrum nigræscens.
 trispærmum.
Tradescantia crassifolia.
Trifolium canescens.
 badium.
 armenium.
 alpestre.
Trillium aconitifolium.
Uvularia sinensis [Disporum fulvum].
Ferbascum australe.
 condensatum.
 montanum.
 holothysum.

Verbascum viscidulum.
majale.
glabrum.
Verbena chamædrifolia.

Verbena pulchella.
Veronica repens.
argentea.
montana.

Veronica pinnatifida.
canescens.
Vicia Onobrychia.
Viola sulavis, &c.

List of Rare Plants in the Handsworth Nursery.

Alstræmeria Simsii, or pul-
chella.
tricolor, or Flôs Martini.
Hookeri, or rosea.
hirtella.
psittacina.
Anemone Halleri.
thalictroides flore pleno
* [Thalictrum anemone-
ides flore pleno].
Aquilegia glandulosa.
Adenophora denticulata.
marsupiflora.
Calceolaria purpurea.
Fothergillii.
thyrsiflora.
plantagina.
Campánula rotundifolia flore
pleno.
grandiflora.
maerantha.
Catananche alba.
Cineraria sibirica.
Cypripedium Calceolus.
pubescens.
spectabile.
Dentaria digitata.
Diânthus Fischeri.
Dodecâtheon Meadia albiflora.
Dracoccephalum altaïense Sw.
alticum.
Erythrolœna conspiciua.
Hemerocallis folva variegata.
Hyacinthus amethystinus.

Hyoseyamus orientalis.
physaloides.
Hypoxis erecta.
Iris tuberosa.
Jeffersonia diphylla.
Lathyrus californicus.
venosus.
Leucocyjum vernum.
Liatris spherodea.
Lilium longiflorum.
pennsylvanicum.
japonicum.
Lupinus tomentosus niveus.
lepidus.
Márica bermudiána.
Eurothera tetragona.
Oudis spinosa alba.
Onosma arenarium.
tauricum.
O'robis sylvaticus.
variegatus.
Pædnia lobata.
pubens.
villida.
Papaver alpinum.
erbecum.
Pentstemon Richardsonii.
ovatus.
Phlomis tuberosa.
pungens.
Phlox caroliniana.
longiflora, or tardiflora.
canadensis.
Potentilla Russelliana.

Potentilla coccinea.
Briennia.
taurica.
Primula minima.
Pulmonaria deprecata [?].
mollis.
Sagittaria latifolia pleno.
Salvia campestris.
Sida malvæflora.
Silene maritima flore pleno.
pennsylvanica.
Soldanella minima.
Stachys cœrsica alba.
co. rubra.
Stréptopus roseus.
Stáctis tatarica.
Tagetes florida.
Tigridia conchiflora.
Tradescantia congesta.
Trillium grandiflorum.
sessile.
Trollius americanus superbus
patulus.
europæus nanus.
Tulipa sylvestris.
Uvularia puberula.
Viola pedata.
pennsylvanica.
digitata.
Whitleya stramonifolia.
Zephyranthes grandiflora.
carinata.
Andersoni.

List of some of the Green-house and Hot-house Plants in the Handsworth Nursery.

Acacia verniciflua.
lanigera.
Anagallis Marryattæ.
Andrœmeda buxifolia.
Anthocœris viscosa.
Astragalus Wallchii.
Azalea sinensis.
indica phœntœa.
hybrida.
Bigonia æquinoctialis.
Billbergia fasciata.
Boronia denticulata.
serrulata.
Bossiaea linifolia.
buxifolia.
Brunsvigia falcata.
toxicaria.
Buonaparteæ Juncœa.
Cætus Jenkinsonii.
Calanthe veratrifolia.
Calceolaria bicolor.

Calceolaria sp. Lima.
Cussonia spicata.
Cymbidium reflexum.
Cypripedium venustum.
Daviesia ulicina.
Dendrobium speciosum.
Dionæa Muscipula.
Escallonia rubra.
bifida [montevideensis].
multiflora.
Eutaxia pungens.
Flemingia semialata.
Gardnia amœna.
Gastrolobium bilobum.
Gloriosa superba.
Gloxinia hirsuta.
Hovea Celsii.
lanœolata.
Jacksonia scoparia.
Kennedyæ coccinea.
Lambertia echinata.

Lophospermum erubescens.
Magnolia Soulangeana.
Mirbella speciosa.
Nandina domestica.
Oxylobium retusum.
Passiflora racemosa coccinea,
cærulea pallida, two seed-
lings raised at the Hands-
worth Nursery.
Penæa imbricata.
Phycella ignea.
Podolbium staurophyllum.
Polysgala grandiflora.
Pultenæa stipularis.
Rhododendron arbdreum.
Strelitzia reginae.
ovata.
humilis.
parvifolia.
juncœa.
&c. &c. &c.

List of some of the more rare hardy Trees and Shrubs in the Handsworth Nursery.

Arbutus procera.
Azalea, Pope's superba.
pónica alba, 2 varieties.
procumbens.
Cystis purpureus albus.
Gaulthéria Shællon.
Pinus dahurica.
intermedia.

Pinus Plecta.
Strôbus nana.
*Rhododendron ponticum pyg-
mæum*.
chrysanthum.
fragrans.
Chamæcistus.

Ribes Dikuschæ.
sangufineum.
viscosissimum.
Weeping Prune.
Weeping Oak.
White-flowered Laburnum,
&c. &c. &c.

To the above lists, made out at your desire, we may add that we grow upwards of eighty sorts of phloxes, and more than fifty sorts of pæonies. — *John Pope and Sons. Handsworth Nursery, May 20, 1831.*

The garden library at the Handsworth Nursery ranks among the most complete, and the books are freely lent out to whoever will make a good use of them.

SCOTLAND.

AYRSHIRE.

The Nurseries and Botanic Grounds of Messrs. Smith and Sons, at Ayr, Monkwood, and Colroy, were founded by Mr. Smith, sen., about 1820. They contain several acres, with a green-house, pits, and frames; and are devoted to a general collection, and more particularly to rare and curious herbaceous plants, and to trees and shrubs. There is a seed-shop in Ayr, and a few seeds are grown. We have already (Vol. VI. p. 713.) given a select list of these; and, in one of our earliest Numbers (Vol. II. p. 129.), a list of North American plants, with remarks on their culture, derived from observations made in America by Mr. Goldie, Mr. Smith's son-in-law, and one of his partners. Mr. Goldie has a small garden at Colroy, in which, in the summer of 1831, he flowered the following species:—

<i>Primula pusilla, sibirica, amœna, and Palinuri.</i>	<i>Nuttallia digitata.</i>	<i>Scorzonera humilis.</i>
<i>Cyclamen ibericum.</i>	<i>Habenaria spectabilis, orbiculata, dilatata, and fimbriata.</i>	<i>Viola mirabilis and campetris</i>
<i>Colechium umbratum and *bulbocodioides.</i>	<i>Lychuis chalcidonica flore albo *pleno.</i>	<i>Tulipa tricolor, bifida, and Celsiana.</i>
<i>Galanthus plicatus.</i>	<i>Pedunia tenuifolia *fl. pleno.</i>	<i>Fritillaria leucantha, and minor.</i>
<i>Ixiolirion (Amaryllis W.) tartaricum.</i>	<i>Corydalis bracteata.</i>	<i>Houstonia serpyllifolia.</i>
<i>Panax trifolium and quinquefolia</i>	<i>Malaxis ophioglossoides</i>	<i>Delphinium grandiflorum var. *Barbivi.</i>
<i>Ornithogalum ciliatum H. R.</i>	<i>Rinunculus *longicollis, frigidus, cardiophylus, and chærophylus.</i>	

In his collection are also the following:—

<i>L'ris paradoxia, *lævigata, and pumila lutea.</i>	<i>Malaxis *unifolia.</i>	<i>Scheuchzeria palustris.</i>
<i>Colechium *lætum.</i>	<i>Rhododendron lapponicum.</i>	<i>Anthriscum serotinum.</i>
<i>Merenddera caucasia.</i>	<i>Dryas integrifolia and Drummondii.</i>	<i>Silene regia.</i>
<i>Leontice altaica and vesicaria.</i>	<i>Dodecatheon integrifolium.</i>	<i>Trillium caucasicum.</i>
<i>Fritillaria ruthénica.</i>	<i>Gerardia quercifolia.</i>	<i>Campanula *Pallasiana and Saxifraga.</i>

In the nursery at Ayr, we noticed strong plants of *Ribes sanguineum*, *Wistaria Consequana*, *Caprifolium flexuosum*, *japonicum*, and *pubescens*, *Piptanthus nepalensis*, and a number of other shrubs reckoned rare and valuable in the London nurseries. At the Monkwood nursery we saw a curious collection of herbaceous plants, many of them very rare, growing up, not altogether without weeds, “in a friendly manner,” as expressed by Mr. Smith, sen., an enthusiastic botanist, and a most benevolent, kind-hearted, and apparently happy man. With respect to the mixture of weeds with rare plants, the former by no means do the injury to the latter that at first sight one would be apt to imagine. Plants which would soon be lost in the loose dug earth of a garden are preserved from extremes of temperature, and from mechanical changes in the soil, by the shade, shelter, and firm and consistent texture given by weeds, especially perennials; for it must always be recollected, that the object in a botanic garden is not to cultivate plants, but to preserve them. The botanic garden of the late eminent botanist, Mr. Don, at Forfar, is said to have been managed in the same style as that of Mr. Smith at Monkwood.

There is a small garden library kept in the nursery at Ayr; but the great resource of the Ayrshire gardeners is the Ayrshire Horticultural Library.

STIRLINGSHIRE.

The Stirling Nurserymen, Messrs. W. Drummond and Sons, held an agricultural and horticultural exhibition at their premises during the first and second weeks in December, which reflects the highest credit on these gentlemen, by whose spirited exertions it was got up, more especially as there is no agricultural society in the county. It was held in a large room on their premises, 70 ft. long and 15 ft. wide, with ample light. Their correspondents and customers in all parts of the country were invited to send in field and garden articles; and, accordingly, extensive collections of turnips, carrots, field beet, potatoes, wheat, barley, oats, beans, peas, tares, rye, groats, malt, pot barley, oatmeal, barleymeal, peasemeal, linseedmeal,

wheaten flour, potato flour from frosted and from damaged potatoes, flax dressed and undressed, red clover plants in flower, maize with ears fully ripened, cattle cabbage; iron ploughs, harrows, and wheelbarrows; a barley hummieller, a turnip rammer, draining tiles, linseed oil cake; bone dust, coarse and fine; sea weed, different sorts, named; dried specimens of grasses, named; forty-two specimens of grass seeds, named; a collection of rare and valuable agricultural seeds, named. Messrs. Drummond themselves, amongst other things, exhibited *Astragalus bœoticus*, the seeds of which are used as a substitute for coffee; *Hemerocallis fulva* and *Symphytum asperrimum*, which have been recommended in this Magazine as herbage plants; and the Irish whin, with a view to its trial as green food. [As this, perhaps, mere variety of the common whin seldom, if ever, produces seeds, its propagation would be too expensive.] Among the turnips exhibited were two of the white globe variety, weighing 23 lbs. each; of the green-topped yellow, one weighed 17 lbs.; of the Swedish, one 14 lbs.; and several specimens of each kind weighed nearly as much. The heaviest field carrot weighed 3 lbs. 3 oz., and the heaviest field beet 8 lbs. 8 oz. An acre of carrots, on mossy soil, weighed 22 tons; on trenched ploughed soil, 29 tons; and on a medium loam, 24 tons. Among the garden produce were the following:—

From Castle Toward (Mr. James Sinclair, gardener), a green-topped Swedish turnip, 21 lbs. 8 oz.; one ditto, 17 lbs., manure, bone dust and sea weed; Altringham carrots, some of which were 24 in. long, and weighed 4 lbs. 12 oz.; early horn ditto, 1 lb. 8 oz. each; parsneps, 22 in. long, and weighing 3 lbs. 5 oz. each; leeks, 6 in. in girth, and well blanched; also Brussels sprouts, parsley, beet, and onions. From Mr. John Rankine, gardener, Kilsyth, an Altringham carrot, weighing fully 9 lbs., and measuring 22 in. in circumference; four others, same variety, weighing in the aggregate 20 lbs. 2 oz.; soil, light; manure, cow-dung. From Airthrey Castle (Mr. Cathie, gardener), turnip-rooted celery, golden beet, 6 lbs. 13 oz., and other specimens. From Boquhan (Mr. Reid, gardener), three globe gourds, respectively 61 lbs., 37 lbs. 8 oz., and 29 lbs. 8 oz. From Mount Stewart, Bute (Mr. Smith, gardener), Altringham carrots, one of which was 4 lbs. 4 oz., and 24 in. long; one Portugal onion, 1 lb., and 15 in. in circumference; one Deptford ditto, 13 oz.; flag leek, 6 in. in girth, and well blanched; one white stone turnip, 14 lbs., and other specimens. From Blair-Drummond (Mr. J. Drummond, gardener), one red beet, 12 lbs. 6 oz.; green-spotted edible gourd, 15 lbs., taken from a single plant which produced 44 fruit, weighing altogether 458 lbs., and producing fruit at the rate of 3 lbs. 5 oz. per day; silver beet, and black-seeded scarlet running beans. From Dunmore Park (Mr. Taylor, gardener), red beet, 9 lbs. 8 oz. From Airth Castle, two drumhead cabbages, respectively 36 lbs. and 31 lbs. From Kippenross (Mr. William Somerville, gardener), drumhead cabbage, 20 lbs.; Savoy, 14 lbs.; new Spanish gourd, 20 lbs.; tall German green, nearly 5 ft. high, and 25 ft. round. From Craigforth (Mr. Hugh M'Coll, gardener), rock gourd and fruited egg plant. From Touch House, silver beet, red beet, and leeks of great size. From Mr. Morrison, Commercial Bank, Stirling, imperial turnip. From Mr. George Chalmers, Stirling, a red onion, 12 oz.; leeks, 5½ in. in girth. Mr. M'Nab, Cowie, very large onions. Mr. A. Allan, Stirling, red beet sown in July. Mr. Kay, Shiphaugh, Bath beet, seed own saving. Coney Park Nursery, drumhead cabbage, 20 lbs.; egg plant; pumpkins, 29 lbs. each; German greens, &c. Mr. Colin Wright, Manorsteps, a Portugal onion, 1 lb. Mr. Sawers, writer, Stirling, a Portugal onion, 1 lb. 3½ oz. (foreign growth). Mr. Affleck, Newhaven, Musselburgh leeks, 6 in. in girth.

The best standard works, and all the periodicals, both of agriculture and horticulture, were also exhibited.

For more ample details, many of which are of great interest to the

farmer, and for a very ably composed introductory address, we refer to the *Stirling Advertiser* of Dec. 9. 1831.

We consider this exhibition of great interest, as it shows what may be done by any nursery and seedsman of spirit. Were such exhibitions attempted generally, the result, we are sure, would be not less advantageous to tradesmen than to their customers, and, we believe, would do much to counteract that general notion among country gentlemen, that seeds and plants are obtained of better qualities from London and Edinburgh than from local nurseries, of which, in the introduction to this article, we have endeavoured to show the fallacy.

ART. XI. Provincial Horticultural Societies.

WE are much gratified to observe, from the lists of prizes given below, that the newest and best fruits and flowering shrubs are spreading rapidly through the country. Of these, we may advert particularly to the Flemish pears; some of which, such as the Marie Louise, Passe-Colmar, Beurré Spence, Glout Morceau, &c., cannot be too often or too greatly recommended. Of the old pears, it will be seen that Gansell's Bergamot has most frequently gained prizes. Of the apples, the Downton, Ribston, and Ingestrie Pippins have been more successful this season than any of the new varieties. We refer, for the other fruits, to the lists. In the flower department, attention may be directed to the numerous varieties of georginas, phloxes, salvias, and calceolarias which have been lately introduced. Of the carnations, Paul Pry seems the most general favourite; and of the pinks, the varieties introduced by Mr. Bow, near Manchester, particularly his Suwarrow. The erythras and cacti have been most successful among the green-house and hot-house plants; and the *Calámpelis scábra* and *Lophospérnum crubescens* among the climbers. The latter, though quite new, is found every where; and we hope, in the next spring shows, to find that our favourites, *Ribes sanguineum*, *Wistária Consequána*, and *Chimonánthus fragrans*, are become equally well known and generally distributed. — *J. W. L. for Cond.*

ENGLAND.

BEDFORDSHIRE.

Bedfordshire Horticultural Society.—The show of auriculas was very fine, and the colours very splendid, particularly those of the green and grey edges; no fewer than 63 pots were exhibited for prizes. The cacti of Mr. Bundy and Mr. Clarke excited universal admiration: that of Mr. Bundy had six varieties worked into one plant, by means of an incision being made in the plant, and the grafts of five varieties being pointed and pegged in; when, in four or five days, the oozing from the plant firmly cemented the whole together. The apples shown by Mr. C. Clarke were of most excellent flavour; they were gathered when dry, and immediately packed in a wine hamper, having hay at the bottom, sides, and above the fruit, of which there were about three bushels. They were placed in a dry situation, and not disturbed till a week previous to the Show, when only three apples were found decayed. (*Cambridge Independent Press*, May 7. 1831.)

LANCASHIRE.

Manchester Botanical Society. — Oct. 5. 1831. Owing to the genial season which we have experienced, the garden fruit was generally much finer than that exhibited last year, and commanded the admiration of all who saw it. The most remarkable part of it consisted of the pears and apples shown by Mr. C. J. S. Walker of Longford. There was also a very large apple, the name of which was not attached to it, but which was no less than 15 in. in circumference, and 18½ oz. in weight. A Suttontown pear was also exhibited, measuring 15½ in., and weighing, we understand, upwards of 1½ lb. Neither of these fruits, however, belonged to members of the Society; and they were, consequently, not entitled to any of the prizes. The Meeting was held in the botanic garden. The green and hot-houses of this establishment are receiving fresh acquisitions every week; and, within the last one or two weeks, very considerable collections were received from the royal botanic garden at Edinburgh, the Caledonian Horticultural Society, and the botanic garden at Glasgow. The good arrangements and cleanliness bear strong testimony to the taste and assiduity of the curator, Mr. Mowbray. Among the prizes were: — Pines: 1. Globe, G. Scholes, Esq.; 2. Montserrat, E. Lloyd, Esq.; 3. Otaheitan, G. Scholes, Esq. — Grapes: 1. Black Humbergh, R. Potter, Esq.; 2. White Tokay, and 3. Lombardy, G. Scholes, Esq.; 4. White Frontignac, R. W. Barton, Esq. — Plums: 1. Golden Drop, Rev. J. Clowes; 2. Impératrice, Thomas Markland, Esq. (*Country Times*, Oct. 17. 1831.)

Rochdale Floral and Horticultural Society. — July 6. 1831. The named prizes awarded at the Third Exhibition were as follows: —

Plants. Stove or Green-house: 1. *Cereus speciosissimus*, G. Priestley, Esq.; 2. *Erythrina Crista galli*, I. Lee, Esq.; 3. *Pimelæa Ænifolia*, G. Priestley, Esq.; 4. *Calceolária thyrsoïdæ*, and 5. *Lilium longiflorum*, Mr. James Tate; 6. *Pimelæa rosea*, G. Priestley, Esq.; 7. *Petunia nyctaginiflora*, C. Royds, Esq. — Herbaceous: 1. *Gaillardia bicolor*, Mr. J. Ecroyd; 2. *Pentstemon pulchellus*, Mr. James Tate; 3. *Dianthus Fischèræ*, G. Priestley, Esq.; 4. *Chelone digitalis*, Mr. J. Hoyle; 5. *Lýchnis fulgens*, Mr. H. Midgley; 6. *Dianthus formosus*, Mr. James Tate; 7. *Pentstemon ovatus*, Mr. H. Midgley; 8. *Delphinium grandiflorum*, Mr. John Whitworth; 9. *Campánula macrantha*, Mr. H. Midgley; 10. *Lýchnis chalcædonica*, Mr. J. Taylor. — Hardy Shrubs: 1. *Andrómæda pulverulenta*, and 2. *Lonchocarpus rubeus*, Mr. R. Schofield; 3. *Calóphaca wolgarica*, Mr. R. Robertson; 4. *Calámpelis scábra*, Mr. J. S. Lancashire; 5. *Heliánthemum vulgäre flóre plèno álbo*, J. Starkie, Esq.; 6. *Escallónia rúbra*, Mr. H. Midgley.

Flowers. Pinks. Premier Prize, Bow's Suwarrow, Mr. J. Ecroyd. Purple-laced: 1. Bow's Suwarrow, Mr. J. Ecroyd; 2. Bow's Lustre, Mr. T. Smith; 3. Fryer's Brilliant, and 4. Sir John, Mr. W. Lodge; 5. Bow's Claudius, Mr. James Whitworth; 6. Newall Hero, Mr. J. Ecroyd;

7. Fletcher's Lancashire Lad, Mr. T. Travis; 8. Invincible, Mr. J. Wild. Red-faced: 1. Elkin's George the Fourth, Mr. T. Smith; 2. Faulkner's Mars, Mr. J. Wild; 3. Faulkner's Jupiter, and 4. Brundritt's Humphry Cheetham, Mr. W. Lodge; 5. Thompson's Princess Charlotte, Mr. J. Ecroyd; 6. Bow's Maryanne, Mr. H. Midgley; 7. Cheetham's Independent, Mr. W. Lodge; 8. Lady Grey, Mr. J. Ecroyd. Black and white: 1. Bow's Premier, Mr. J. Etches; 2. Beauté de Flora, Mr. T. Travis; 3. Bow's Cicero, Mr. W. Lodge; 4. Bang Europe, Mr. J. Clegg; 5. Vicker's Duchess of Rutland, Mr. J. Dalton; 6. Duchess of Manchester, Mr. W. Lodge; 7. Bow's Queen of June, Mr. J. Ashton; 8. Partington's La Mère Brune, Mr. J. Etches. — *Hanunculuses*. Striped: 1. Quilla filla, 5. Gunner, 4. Mélange des Beautés, and 5. Rose Blanche, Mr. James Tate. Yellow-edged Spotted: 1. Orange Brabançon, 2. Dr. Franklin, and 4. Bouquet Sanspareil, Mr. James Tate. Grey or purple-edged: 2. Hosier, and 3. Queen Harbeker, Mr. James Tate; 4. Tendresse, Mr. Joseph Tate; 5. Mirror, Mr. J. Etches. White edged Spotted: 1. Darius, 2. Téméraire, and 3. Mignon, Mr. James Tate; 4. Nutmeg, and 5. Condoree, Mr. Joseph Tate. Dark Self: 1. Cassandra, and 4. Defiance, Mr. Joseph Tate; 5. Scarlet and Gold, Mr. James Tate. Light Self: 2. Cecil, 3. Amaranth, and 4. Carmine, Mr. James Tate. — *Pelargoniums*. Grown with Green-house: 1. Lord Combermere, and 2. De Vey, Mr. James Tate; 3. Spectabile, 1. Entwisle, Esq.; 4. Anne Boleyn, G. Priestley, Esq.; 5. Lady Essex, 1. Entwisle, Esq. Grown without Green-house: 1. Mount Etna, Mr. H. Midgley; 2. Davenportum, Mr. J. Taylor; 3. Anne Boleyn, and 4. Dennis's Rival, Mr. J. S. Lancashire; 5. Feronia, Mr. J. Cheetham. — *Roses*. Red Moss, Mr. R. Robertson. White Moss, Mr. Joseph Tate. Red or Blush: 1. Entwisle, Esq. Marbled or Striped, 1. Entwisle, Esq. Dark: 1. Tuscany, Mr. M. Greenlees; 2. Atlas, Mr. R. Robertson. White: Unique, Mr. R. Robertson. Monthly: 1. New climbing, and 2. Crimson, Mr. James Tate.

Fruit. Grapes: 1. Lombardy, 1. Entwisle, Esq.; 2. and 3. Black Hamburgh, C. Roys, Esq. — Strawberries: 1. Keen's Seedling, 1. Starkie, Esq.; 2. Keen's Seedling, 1. Entwisle, Esq.; 3. Keen's White, Mr. J. Holland.

Culinary Vegetables. Potatoes. Kidney: Unwin's Kidney, Mr. A. Fothergill. Round: 1. Golden Dwarf, and 2. and 3. Fox's Seedling, Mr. J. Ecroyd.

Extra-Prizes. Cladánthus arábicus, Mr. A. Fothergill. Red Kidney Potatoes, Mr. J. Ecroyd. — *Alex. Fothergill, Secretary.*

August 10. 1831. The named prizes awarded were as follows: —

Plants. Stove or Green-house: 1. *Roëlla ciliata*, Mr. J. Tate; 2. *Crassula coccinea*, Mr. J. Heath; 3. *Calceolaria bicolor*, and 4. *Alstromëria Pelegrina*, Mr. J. Tate; 5. *Hedýchium aurantiacum*, 1. Entwisle, Esq. F.H.S.; 6. *Lilium longiflorum*, Mr. J. Tate; 7. *Spigelia marilandica*, Mr. J. Ashworth. — *Herbaceous*: 1. *Enothera speciosa*, Mr. R. Schofield; 2. *Campánula pyramidalis*, 1. Lee, Esq.; 3. *Phlox formosa*, Mr. J. Tate; 4. *Potentilla Russeliána*, Mr. R. Robertson; 5. *Pentstemon angustifolius*, Mr. H. Schofield; 6. *Phlox Wheelersii*, and 7. *Dianthus formosus*, Mr. J. Tate; 8. *Chelone barbata*, Mr. R. Robertson. — *Hardy Shrubs*: 1. *Calampelis scabra*, Mr. R. Schofield; 2. *Escallonia rubra*, G. Priestley, Esq.; 3. *Colutea arborescens*, Mr. R. Robertson; 4. *Cytisus capitatus*, Mr. W. Newall; 5. *Potentilla floribunda*, C. Roys, Esq. — *Annuals or Biennials*: 1. *Clárkia pulchella*, Mr. A. Fothergill; 2. *Gilia capitata*, 1. Entwisle, Esq. F.H.S.; 3. *Collinsia grandiflora*; and 4. *Schizánthus pinnatus*, Mr. R. Schofield; 5. *Enothera* sp., Mr. R. Robertson.

Flowers. Carnations. Premier Prize, Wilde's Perfection, Mr. J. Whitworth. Scarlet Bizarres: 1. Wilde's Perfection, Miss Jane Clough; 2. Friday Night, 3. Lee's Lord Nelson, and 4. Davey's Sovereign, Mr. J. Whitworth; 5. Walmesley's William the Fourth, C. Lee; 6. Waterhouse's Rising Sun, Mr. J. Whitworth; 7. Duke of Leeds, and 8. Roby's William the Fourth, George Priestley, Esq. Pink or Crimson Bizarres: 1. Alfred, Mr. J. Walmesley; 2. Rainbow, Mr. C. Lee; 3. Paul Pry, Miss Jane Clough; 4. Memnon, Mr. J. Wild; 5. Woodhead's Spitfire, G. Priestley, Esq.; 6. Butcher's Jolly Tar, Mr. J. Wilde; 7. Potter's Sir William, Mr. J. Clegg; 8. Bang Europe, Mr. H. Thomas. Purple Flake: 1. Leighton's Bellerophon, Mr. J. Walmesley; 2. Wood's Commander, W. Turner, Esq.; 3. Hall's Major Cartwright, Mr. C. Lee; 4. Lady Wilton, Mr. J. Dalton; 5. Turner's Princess Charlotte, and 6. Bates's Wellington, Mr. C. Lee; 7. Othello, Mr. J. Walmesley; 8. Godfrey Mundy, Mr. J. Hardman. Scarlet Flake: 1. Madame Mara, and 2. Potter's Champion, Mr. C. Lee; 3. Woodhead's Superior, Mr. J. Wilde; 4. Stearn's Dr. Barns, Mr. T. Travis; 5. Rowton, Mr. J. Wilde; 6. Pearson's Rising Sun, Mr. J. Whitworth; 7. Queen Adelaide, G. Priestley, Esq.; 8. Orson's Rob Roy, Mr. J. Hardman. Rose Flake: 1. Duchess of Devonshire, Mr. T. Travis; 2. Faulkner's Eliza, Mr. J. Whitworth; 3. Lancashire Lass, Mr. C. Lee; 4. Lady Stanley, Mr. J. Dalton; 5. Lady Hood, Mr. J. Whitworth; 6. Supreme, Mr. J. Hardman; 7. Clegg's Beauty, Mr. J. Walmesley; 8. Ruler of England, Mr. C. Lee. — *Picotees*. Premier Prize, Lee's Cleopatra, Mr. C. Lee. Red Feathered: 1. Miss Bacon, Mr. J. Whitworth; 2. Wdl Stukeley, W. Turner, Esq.; 3. Hird's Alpha, Mr. A. Fothergill; 4. Queen Anne, Mr. T. Smith; 5. Mrs. Roy, Mr. J. Clegg; 6. Childwell Beauty, Mr. J. Cheetham. Red-striped: 1. Lady Nelson, Mr. T. Travis; 2. Bright Star, Mr. C. Lee; 3. Seedling, Mr. H. Thomas; 4. Phoenix, Mr. J. Dalton; 5. England's Defiance, Mr. J. Whitworth; 6. Conductor, Mr. C. Lee. Purple-feathered: 1. Cleopatra, 2. Princess Victoria, and 3. Miss Emma, Mr. C. Lee; 4. Lovely Ann, Mr. J. Hardman; 5. Lord Wellington, Mr. J. Taylor; 6. Fair Helen, Mr. C. Lee. Purple-striped: 1. Albion, and 2. Dalton's Molly, Mr. J. Wilde; 3. Lord Nelson, Mr. C. Lee; 4. Fair Helen, W. Turner, Esq.; 5. Royal Purple, Mr. H. Thomas; 6. Beauty of Bury, Mr. T. Travis. — *Georginas*. Double: 1. Scarlet Turban, Mr. J. Tate; 2. Black Turban, Mr. W. Lodge; 3. Blush Lilac, Mr. J. Tate; 4. Crinon Globe, Mr. W. Lodge. Single: 1. Seedling, 2. Middletonia, and 3, 4, and 5. Seedlings, Mr. J. Ashworth. — *Pelargoniums*. Grown with Green-house: 1. Spectabile maculatum, G. Priestley, Esq.; 2. Cliftonianum 3. Hamei, and 4. Seedling, Mr. J. Tate. Grown without Green-house: 1. Vilnorinidnum, 2. Defiance, and 3. Dennis's Rival, Mr. J. S. Lancashire; 4. Macranthon, Mr. J. Cheetham.

Fruit. Grapes: 1. Black Hamburgh, J. Lee, Esq.; 2. Tokay, 1. Entwisle, Esq. F.H.S. — *Melon*: Suceada, 1. Entwisle, Esq. F.H.S. — *Gooseberries*. Red: 1. Roaring Lion, 22 dwts. 2 grs., Mr. T. Gee; 2. Sir John, 18 dwts. 50 grs., Mr. T. Clegg; 3. Prince Regent, 17 dwts. 7 grs., Mr. T. Gee; 4. Briton, 16 dwts. 21 grs., and 5. Lancashire Lad, Mr. E. Elliott; 6. Huntsman, Mr. C. Lee. Green: 1. Jolly Angler, 19 dwts. 10 grs., and 2. Favourite, 18 dwts., Mr. E. Elliott; 3. Greenwood, 15 dwts. 14 grs., Mr. W. Taylor; 4. Ocean, 15 dwts. 10 grs., Mr. S. Wilde; 5. Emerald, 13 dwts. 5 grs., Mr. J. Clegg; 6. Lord Byron, 13 dwts. 4 grs., Mr. W. Crossley. Yellow: 1. Gunner, 18 dwts. 12 grs., and 2. Duckwing, 16 dwts. 22 grs., Mr. E. Elliott; 3. Husbandman, 16 dwts. 17 grs., Mr. W. Taylor; 4. Leader, 16 dwts. 4 grs., 5. Teazer, 15 dwts. 7 grs., and 6. Bunker's Hill, Mr. S. Wilde. White: 1. Eagle, 17 dwts. 18 grs., C. Roys, Esq.; 2. First-rate, 16 dwts. 1 gr.,

Mr. W. Taylor; 3. Nonpareil, 16 dwts., Mr. R. Crabtree; 4. Queen Caroline, 15 dwts. 15 grs., C. Roysd, Esq.; 5. Nailer, 14 dwts. 16 grs., Mr. W. Crossley; 6. Bonny Lass, 13 dwts. 11 grs., Mr. J. Smith. Heaviest plate of twenty: 1. Roaring Lion, 20 oz. 15 dwts., Mr. E. Elliot; 2. Roaring Lion, 20 oz. 3 dwts., Mr. S. Wilde. — *J. Eroyd. Aug. 1831.*

NORTHAMPTONSHIRE.

Northamptonshire United Horticultural Society. — April 19. 1831. Prizes were awarded as under: —

Plants. Stove: 1. *Cereus speciosissimus*, Mr. J. Atkins; 2. *Epiphyllum speciosum*, E. Bouverie, Esq. — Green-house: 1. *Azalea indica alba*, 2. *Azalea indica purpurea plena*, 3. *Camellia Sasangua rosea*, 4. *Camellia atrovirens*, 5. *C. alba plena*, and 6. *Acacia armata*, Mr. J. Atkins. — Hardy Herbaceous: 1. Blood Wallflower, Mr. J. Holliday; 2. Lancashire Green-top Wallflower, Mr. P. Cornfield; 3. *Doronicum caucasicum*, Mr. J. Atkins. — Hardy: 1. *Ledum thymifolium*, 2. *Ulex europæa plena*, and 3. *Cytisus sessilifolius*, Mr. J. Atkins.

Flowers. Auriculars. Green-edged: 1. Wood's Lord Lascelles, Mr. R. Orson; 2. Metcalf's Lancashire Hero, Mr. S. Bryan; 3. Lee's Colonel Taylor, Mr. J. S. Smith; 4. Warris's Blucher, and 5. Duchess of Oldenburgh, Mr. J. Atkins. Grey-edged: 1. and 2. Lancashire Hero, 3. Page's Lord Hill, 4. Blagden's Duke of Wellington, 5. Grimes's Privateer, and 6. Kenyon's Ringleader, Mr. J. Atkins. White-edged: 1. Poplewell's Conqueror, Mr. J. Holliday; 2. Hughes's Pillar of Beauty, Mr. S. Bryan; 3. Taylor's Glory, and 4. Kenyon's Lord Chancellor, Mr. R. Orson; 5. Butterworth's Lady Wellington, Mr. J. Atkins. Selfs: 1. Dixon's Apollo, Mr. J. Atkins; 2. Nelson's Funeral Car, Mr. S. Bryan; 3. Scholes's Ned Lud, Mr. J. S. Smith; 4. Oddy's Lady Milton, Mr. S. Bryan. Alpine: 1. King of the Alps, Mr. J. S. Smith; 2. Polycarp, Mr. S. Bryan; 3. Alpine King, Mr. J. Martin. — Forced Flowers: Mignonette, Mrs. Kerr.

Fruit. Apples: 1. King of the Sauce, L. Rokeby, Esq.; 2. Northern Greening, H. Terry, Esq. — *C. Northampton, April, 1831.*

June 23. Prizes were awarded as under: —

Plants. Stove: 1. *Cereus speciosissimus*, and 2. *Gloxinia speciosa*, E. Bouverie, Esq. — Green-house: 1. *Fuchsia virgata* (a standard 8 ft. high), Mr. J. Atkins; 2. *Fuchsia gracilis* (8 ft. high), E. Bouverie, Esq.; 3. *Lophospermum erubescens*, Mr. J. Atkins; 4. *Vallota purpurea*, E. Bouverie, Esq.; 5. *Salpiglossis atropurpurea*, and 6. *Gladolus cardinalis*, Mr. J. Atkins. — Hardy Herbaceous: 1. *Pæonia Whiteleyi*, 2. Spanish Irises, 3. Bouquet of cut flowers of *Fescholtzia californica*, *Aquilegia glandulosa*, *Tuula glandulosa*, *Lupinus polyphyllus albus*, *Delphinium azureum*, and *Gaillardia bicolor*, Mr. J. Atkins. — Hardy Shrubs: 1. *Kalmia latifolia*, 2. *Kalmia angustifolia*, and 3. Sulphur-coloured Broom, Mr. J. Atkins.

Flowers. Ranunculuses: 1. Queen of Wurtemberg, and Black Turban, Mr. J. Atkins; 2. Andrew's spotted Seedling, Thesée, La Favorite, Condoret, and Cedo Nulli, Mr. J. Martin; 3. Naxara, Princess of Wales, Tartar, Thompson's Queen, Pretiosa, Princess of Wurtemberg, and La Carnation, Mr. J. Holliday; 4. Naxara, Janus, Rhododendron, Mélange des Beautés, Nariett[?], La Carnation, and Golconda, Mr. R. Orson. — Pinks: 1. Cheese's Champion, Davey's Victory, Dickins's Sir Francis Burdett, Maltby's Apollo, Patriek's Eclipse, and Pigott's Aurora Borealis, Mr. J. Holliday; 2. Maltby's Apollo, Looker's Oxonian, Bexley Hero, Pittman's Rising Sun, Cheese's Miss Cheese, and Davey's Standard; 3. Knight's Lady Ackland, Matley's Apollo, Cheese's Miss Cheese, Barratt's Conqueror, Dickens's Sir Francis Burdett, and Bexley Hero, Mr. John Atkins; 4. Westlake's Hero, Davey's Britannia, Turner's Regent, Bates's Wellington, Barratt's Conqueror, and Stephens's Harefield Hero, Mr. J. Martin; 5. Bates's Wellington, Humbert's Hero, Stephens's Waterloo, Harefield Hero, Cooper's Cupid, Cheese's Miss Cheese, Mr. J. Holliday; 6. Knight's Lady Ackland, Maltby's Apollo, Woollard's George the Fourth, Day's Queen Elizabeth, Bates's Wellington, and Maltby's Alpha, Mr. P. Cornfield. Seedling, Atkins's Perpetual, Mr. J. Atkins. — Roses: 1. Margin Hip, *Indica major*, Grand Purple, Burning Coals, and 2. Globe White Hip, Favourite Purple, Crimson Moss, Brown's Superb, Pæony, Tuscan, Wellington, and Unique, Mr. J. Atkins; 3. Unique, Blush Monthly, Crimson Moss, Rivers's George the Fourth, Lee's Crimson Perpetual, and Globe White Hip, E. Bouverie, Esq.

Fruit. Grapes: White, Muscat of Alexandria, W. Hanbury, Esq.; Black, Black Hamburg, W. Hanbury, Esq. — Melon, Green-fleshed, E. Bouverie, Esq. — Strawberries: 1. Keen's Seedling, Hon. Mrs. Cockayne; 2. Wilmot's Superb, Mr. T. Barry. — Cherries, May duke, E. Bouverie, Esq.

Culinary Vegetables. Lettuce, Bath Cos, E. Bouverie, Esq.

Cottage's Prizes. Cut Flowers: Pinks, J. J. Ward, Floore. Vegetables: New Potatoes, S. Masters, Northampton. — *C. Northampton, July, 1831.*

July 29. Prizes were awarded as under: —

Plants. Stove: 1. *Hoya carnosa*, Mr. G. Osborn; 2. *Acréstichum alcinon*, Mr. J. Atkins; — Green-house: 1. *Calceolaria Atkinsiana*, Mr. J. Atkins; 2. *Fuchsia cónica*, Mr. G. Osborn; 3. *Agapanthus umbellatus*, W. T. Smith, Esq.; 4. *Lophospermum erubescens*, Mr. J. Smith; 5. *Fuchsia microphylla*, E. Bouverie, Esq.; 6. *Crassula coccinea*, Mr. J. Atkins. — Hardy Herbaceous: 1. *Ilychnis chalcedonica plena*, and 2. *Ænothera missouriensis*, and *Pascalya glauca*, E. Bouverie, Esq.; 3. *Yucca flaccida*, Mr. J. Atkins.

Flowers. Carnations. Scarlet Bizarres (Premium, Martin's British Monarch, Mr. J. Martin); 1. Wilde's Perfection, 2. Thompson's Cartwright, 3. Orson's Rolla, 4. Roderick Dhu, and 5. Sir Robert Peel, Mr. R. Orson. Crimson Bizarres (Premium, Sir Robert Gunning): 1. Gregory's Alfred, Mr. J. Holliday; 2. Orson's Duke of Clarence, Mr. J. Martin; 3. Orson's Lord Lieutenant, Mr. R. Orson; 4. Orson's Apollo, Mr. J. Holliday; 5. Wakefield's Paul Pry, Mr. R. Orson. Seedling, Martin's Lord John Russell, Mr. J. Martin. Scarlet Flakes (Premium, Madame Mara, Mr. J. Holliday): 1. Thornicroft's Blucher, and 2. Orson's Rob Roy, Mr. J. Martin; 3. Holliday's Sir C. Knightley, Mr. J. Holliday; 4. Potter's Champion, Mr. J. Martin. Seedling, Holliday's Dr. Terry, Mr. J. Holliday. Purple Flake (Premium, Turner's Princess Charlotte, Mr. J. Holliday): 1. Layton's Bellerophon, Mr. P. Cornfield; 2. Turner's Princess Charlotte, 3. Martin's Defiance, 4. Miss Wake, and 5. Nott's Alfred the Great, Mr. J. Martin. Seedling, Lord Brougham, Mr. J. Martin. Rose Flakes (Premium, Fletcher's Duchess of Devonshire, Mr. J. Holliday): 1. Fletcher's Duchess of Devonshire, Mr. J. Martin; 2. Smalley's Wonderful, 3. Strong's Princess Augusta, 4. Plant's Lady Hood, and 5. Willner's Timandra, Mr. P. Cornfield. Seedling, Orson's Sylvia, Mr. P. Cornfield. — Picotees. Purple (Premium, Wood's Countess of Sandwich, Mr. J. Holliday): 1. Lee's Lady Chatham, Mr. J. Holliday; 2. Queen Adelaide, Mr. J. Martin; 3. Orson's Rowena, Mr. R. Orson; 4. Martin's Doctor Syntax, and 5. Linnæus, Mr. J. Holliday. Seedling, Lady Isham, Mr. J. Martin. Red (Premium, Princess Victoria, Mr. J. Martin);

1. Russell's Incomparable, Mr. J. Holliday; 2. Purchas's Granta, Mr. P. Cornfield; 3. Earl of Effingham, and 4. Hutton's Will Stukely, Mr. J. Holliday. Seedling, Martin's Eminent, Mr. J. Martin. — Roses: 1. White Moss, Lee's Crimson Perpetual, New Crimson Noisette, Yellow China, Bizarré de la Chine, Odoërata, and 2. Noisette, Watt's China, Purple Noisette, Fragrans, Stephens's China, and Grevilleæ, Mr. J. Atkins.

Fruit. Grapes: White: Chasselas de Fontainebleau, E. Bouverie, Esq. Black: 1. Black Ham-
burgh, E. Bouverie, Esq.; 2. Black Hamburgh, Earl Spencer. — Melons: 1. and 2. Green-fleshed,
E. Bouverie, Esq. — C. Northampton, August, 1831.

NORTHUMBERLAND.

Northumberland and Durham Botanical and Horticultural Society. — Sept. 15. Among the prizes awarded were gold medals to Mr. Wm. Kelly, gardener to A. Donkin, Esq, Jesmond, for the best-flavoured pine-apple (Black Antigua); and to Mr. J. M'Queen, gardener to S. W. Parker, Esq., Scots House, for the best double carnation (Sherwood's Corinthus); and silver medals to Mr. W. Kelly, for the best melon (Scarlet-fleshed Rock); to Mr. J. Scott, gardener to E. Charlton, Esq., Sandhoe, for the second-best double carnation (Highland Boy); and to Mr. J. Ismay, gardener to C. Attwood, Esq., Wickham, for the best dish of jargonelle pears. The only prize (the variety gaining which is named) among the flowers is for the best exotic plant in flower (*Erythrina Crista galli*), to Mr. J. Clark, gardener to Mrs. Bewicke, Close House. The following articles were likewise exhibited:—A bouquet of anemone-flowered georginas, from the garden of J. C. Anderson, Esq., Point Pleasant; *Calcocolaria integrifolia*, from the garden of M. Anderson, Esq., Jesmond; and a dish of Morello cherries, from the garden of Captain C. B. Grey, Styford Hall. (*Newcastle Courant*, Sept., 1831.)

Nov. 4. The bouquets were deservedly worthy of attention, and much credit is due to the exhibitors of them, for the production of so many elegant flowers at this late season of the year, the fruits and vegetables were considered to be in the highest perfection, and the number of splendid exotics gave the whole a rich and most pleasing appearance. Among the prizes were the following:—

To Mr. James Scott, gardener to E. Charlton, Esq., Sandhoe, for the best exotic plant in flower (*Epiphylum truncatum*). To Mr. Jas. Scott, gardener to H. Lamb, Esq., Ryton, for the best six roots of kohlrabi. To Mr. Jas. Scott, gardener to E. Charlton, Esq., Sandhoe, the best dish of succory (*Cichorium Intybus*); and to Mr. T. Cook, gardener to T. W. Beaumont, Esq. M.P., Bywell Hall, for the best six heads of purple broccoli. The following exotics were exhibited, viz.:—*Sálvia splendens*, *Richárdia athiópica*, *Gloxínia speciosa*, *Trevíana coccinea*, and *Epiphylum truncatum*, by Mr. Wm. Kelly, from the garden of A. Donkin, Esq., Jesmond; *Chrysáthemum indicum*, by Mr. J. M'Queen, from the garden of S. W. Parker, Esq., Scot's House; *Sálvia splendens*, by Mr. A. Hedley, from the garden of John Hodgson, Esq. M.P., Elswick Hall; *Lophospermum erubescens*, by Mr. J. Ireland, from the garden of W. Donkin, Esq., Sandhoe; *Sálvia splendens*, and a fine single white camellia, by Mr. A. Simpson, from the garden of W. Losh, Esq., Little Benton. The following articles were exhibited gratuitously, viz.:—A fine dish of white muscadine and black cluster grapes, from the open wall, by Mr. Thomas Watson, from the garden of J. Kirsopp, Esq., Spittal, near Hexham; and a dish of very large cadillac pears, by Mr. T. Cook, from the garden of T. W. Beaumont, Esq. M.P., Bywell Hall. (*Newcastle Courant*, Nov. 12. 1831.)

OXFORDSHIRE.

Oxford Horticultural Show. — Aug. 4. Prizes were awarded as under:—

Flowers. A prize for a seedling georgina was awarded to J. P. Burnard, Esq., architect, of Formosa Cottage, Holloway, near London.

Fruit. Gooseberries. Red (the heaviest 12 berries of each sort): 1. 12 oz. 2 dwts., Mr. J. Fardon, Woodstock; 2. 11 oz. 15 dwts. 6 grs., Mr. Samuel Pain, Woodstock. Yellow: 1. 9 oz. 8 dwts., Mr. J. Fardon, Woodstock; 2. 9 oz. 12 grs., Mr. Edward Bennett, Woodstock. Green: 1. 10 oz. 9 dwts., Mr. J. Fardon; 2. 9 oz. 14 dwts. 2 grs., Mr. P. Pain. White: 1. 11 oz. 6 dwts., Mr. J. Fardon; 2. 10 oz. 10 dwts., Mr. Thomas Lucas, Oxford.

A handsome seedling cucumber, perfectly straight, and measuring upwards of 2 ft. long, produced by Mr. Burnard, was recommended to notice by the judges. (*Oxford Herald*, Aug. 15. 1831.)

SOMERSETSHIRE.

Bristol Botanical and Horticultural Society. — July 21. Among the plants exhibited at the Fourth Show we noticed *Roëlla ciliata*, and *Kalosánthes coccinea*, from Christopher George, Esq.; *Lophospermum erubescens*, from the Rev. Dr. Swete; *Erica viridiflora* and *Walkèri*, from Henry Nugent, Esq.; *Plumbago capensis*, and *Thunbèrgia alba*, from Mr. Mackay. Mr. Miller exhibited two beautiful new plants, *Gladolus natalensis* from the Cape, and *Habránthus* from Chile, both of which he has sent to be figured in the *Botanical Register*. The *Gladolus*, being as hardy as the *Gladolus cardinalis*, will prove a great acquisition to the flower-garden. Amongst the nurserymen's collection we noticed a beautiful new *Calcocolaria* from Mr. Wheeler of Warmminster, and a large *Yucca gloriosa* and *Alstromèria Pelegrina* from Mr. Maule. Some very fine specimens of leaves of the green tea were exhibited by Mr. Rootsey, gathered from a plant that stood the severity of last winter, on the hills of Breconshire, without any shelter; and Mr. Rootsey informs us that it is as hardy as the common lilac and *Chimonánthus fragrans*, and will prove a great acquisition to our hardy evergreen plants. The prizes were awarded as follows:—

Plants. Stove: 1. *Thunbèrgia alba*, Mr. Mackay; 2. *Hoya caribæa*, and 3. *Rheca falcata*, Mrs. Isaac Elton. — Green-house: 1. *Erythrina laurifolia*, John Hurle, Esq.; 2. *Lophospermum erubescens*, Rev. Dr. Swete; 3. *Roëlla ciliata*, C. George, Esq. — Hardy Perennials: 1. *Campaula pyramidalis*, Mr. Elbury; 2. *Fúnkia varèlea*, Mrs. W. Fripp; 3. *Agrostemma coronària*, Mrs. W. Fripp. — Hardy Annuals: 1. *Clárkia pulchèlla*, Rev. T. H. Walker; 2. *Zinnia elegans*, Rev. Mr. Richards.

Fruit. Pine-apples: 1. Enville, and 2. Black Jamaica, Mr. Pillans; 3. Queen, and 4. Enville, W. P. Jillard, Esq. — Grapes: Black: 1. Black Hamburgh, Mrs. Cartwright; 2. Grizzly Frontignac, John New, jun., Esq.; 3. Black St. Peter, Mrs. Cartwright. White: 1. Muscat of Alexandria, Mrs. Cartwright; 2. Muscat of Alexandria, and 3. Nice, John New, jun., Esq. — Apricots: 1. Moorpark, C. W. Bowden, Esq.; 2. Moorpark, Mr. Helps. — Cherries: 1. May Duke, Mrs. H.

Vaughan; 2. Morello, Thomas Cole, Esq. — Pears: 1. Citron des Carmes, Mr. R. Fry; 2. Green Jennett [?], Mr. Sealey. — Gooseberries. Red: 1. Roaring Lion, Thomas Cole, Esq.; 2. Crown Bob, Mr. Z. Cartwright; 3. Sportsman, G. W. Hall, Esq. Green: 1. Angler, Mr. Z. Cartwright; 2. Ocean, Joseph Parker, Esq. Yellow: 1. and 2. Rockwood, Mr. Z. Cartwright; 3. Golden Gourd, Rev. Mr. Richards.

Culinary Vegetables. Celery. White: 1. Mr. Sealey. — Lettuces: 1. Brown Cos, and 2. White Cos, Mr. Gerrish. — Carrots: 1. Altringham, Mr. Maynard, sen.; 2. Orange, Mr. Gerrish. — Turnips: 1. White Stone, Mr. Gerrish; 2. Maltese, Captain G. Langton.

Nurserymen's Prizes. Green-house Plants: Calceolaria Wheeleri, Mr. G. Wheeler; Clerodendrum fragrans, Mr. Allen. Hardy Plants: Yucca gloriosa, Mr. Maule; Hydránga quercifolia, Mr. Allen. Hardy Perennials: Sédum spúrium, and Liatris spicata, Mr. Maule. Hardy Annuals: Coreópsis tinctoria, Mr. Maule.

Bristol and Clifton Horticultural Society. — Sept. 13. The exhibition of flowers and fruit was beautiful and attractive. The georginas and China asters were particularly splendid. A large imperial crown, and two baskets formed of flowers, were suspended on a wreath of hops in full blossom; and the letters W. A., a crown, W. R., and an anchor, formed of the same materials, were placed at the top and bottom of the room, and added to the effect. At the dinner, when the health of Mr. Miller was drunk, that gentleman stated that the Society consisted of upwards of 600 members; that 500 specimens of different productions had been sent that day for exhibition; and that 14l. had been taken for admission. Mr. G. W. Hall, who returned thanks on behalf of the committee, drew the attention of the company to the admirable specimens from the kitchen-garden, which were, indeed, worthy of all commendation, and noticed with great gratification the cottagers' prizes. Mr. Donald, one of the umpires, who is a member of the London Horticultural Society, bore his testimony to the display of fruits, flowers, and vegetables, exhibited that day, which, he said, could only be excelled by the beauty, elegance, and fashion of the assembly who had inspected it. He also complimented the company on possessing in the neighbourhood an establishment matured by Mr. Miller, which he pronounced equal to any in England or in Europe.

Among the plants exhibited were: — Fúchsia grácilis, from J. Hurle, Esq.; Alstroméria ovata, and Plectocéphalus americanus, from Miss Bright; Gros köhl rabi, from W. W. Capper, Esq.; Zingiber officinale, Sálvia splendens, Fúchsia grácilis, and Mangold Wurtzel, from Mr. Alderman Daniel; Nèrium splendens, from O. Fedden, Esq.; Mangold Wurtzel, from H. Sheppard, Esq.; Calceolaria integrifolia, from John Acraman, Esq. Prizes were awarded as under: —

Plants. Stove: 1. Gloriosa superba, P. J. Miles, Esq.; 2. Pápyrus antiquum, J. Hurle, Esq.; 3. Trevirana coccinea, Mrs. W. Fripp. — Green-house: 1. Lagerstrœmia indica, Miss Bright; 2. Ròchea falcata, Rev. M. Richards; 3. Hæmánthus tigrinus, W. P. Taunton, Esq. — Hardy: 1. Gentiana Catesbaei, Rev. H. T. Ellicombe; 2. Phlox suffruticosa, Mrs. W. Fripp; 3. Prenánthes álba, Rev. H. T. Ellicombe.

Fruit. Pine-Apple, Otaheite, Mr. Mackay. — Apples. Early Dessert, Kerry Pippin, Rev. Dr. Swete. Late: 1. Yellow Ingestrie, Miss Swete; 2. Crofton Pippin, George Sawyer, Esq. Culinary: 1. Catshead, Mr. Cartwright; 2. Kentish Pippin, H. Myers, Esq. Cider, Devonshire Red-streak, Miss Player. Seedling, J. Fisher, Esq. — Pears. Dessert: 1. Gansell's Bergamot, Miss Powell; 2. Ambrosia, Captain Langton; 3. Autumn Bergamot, Mrs. M. Philipps. — Peaches: 2. Double Montagne, Rev. Dr. Swete; 3. Galand, Geo. Sawyer, Esq. — Nectarines: 1. Pitmaston Orange, Mrs. Cartwright; 3. Scarlet, Mrs. Clark. — Melons, Nettle Rock, Miss Bright. — Filberts: 1. White, Mrs. H. Vaughan; 2. White, Mr. R. Fry. — Nuts, Cosford, Mr. R. Fry. — Grapes. Black: 1. St. Peter's, and 2. Hamburgh, R. Strachey, Esq. White: 1. Muscat of Alexandria, C. G. Harford, Esq.; 2. Muscat of Alexandria, Mr. Clark. — Out-door: 1. Syrian, C. G. Harford, Esq.; 2. White Muscadine, Mrs. Sheriffe. — Cherries, Morello, T. Cole, Esq.

Culinary Vegetables. Celery, Red and White, Mr. Maynard, sen.

Nurserymen's Prizes. Pines: 1. Enville, and 2. Black Jamaica, Mr. Maule. — Plants. Stove: 1. Gloxinia maculata, and 2. Cactus, Mr. Maule. — Green-house: 1. Erica jasmíniflora, and 2. Grevillea acanthifolia, Mr. Maule. — Hardy, Hibiscus sýriacus, Mr. Allen. — Hardy Perennials, Erythrolœna conspicua [not hardy, surely], Mr. Maule. — Hardy Annuals, Zinnia elegans, Mr. Maule. (*Bristol Mirror*, Sept. 17.)

Taunton and West Somerset Horticultural Exhibition. — Sept. 9. The decorations of the room were very elegant; at the western end were placed two finely covered hop-poles, in profuse bearing: the hops were singularly large and healthy. These were kindly presented by Mr. R. Ham, from the grounds at Orchard Portman, near this town. A star of splendid georginas, of almost every possible diversity of colour, from Young's nursery, suspended over the doorway of the room, attracted great notice, and was certainly very beautiful. Another star of georginas, of different formation, but of singular richness and variety of colour, from Mr. Veitch of Killerton, appeared over the card-room door; and near it was a large crown, also of georginas, supplied by the same nurseryman, in which were some superb flowers. Some German asters were much admired; and some baskets of georginas, from Dymond's, and from Lucombe's of Exeter, displayed admirable specimens of that delightful pageant of our gardens. The grapes were magnificent. There were but few melons, but those shown were capital; a small green one, of exquisite flavour, was honoured with the prize.

A number of prizes were distributed; but the names of the varieties which gained them are not mentioned. (*Taunton Courier*, Sept. 14.)

SUFFOLK.

Bury Horticultural Society. — Sept. 6. The georginas were remarkably fine. Mr. Nunn's collection of seedlings was excellent, and so were Mr. Buchanan's of Stowmarket. Of the flowers not now first produced Mr. Lord bore off the prize, but others approached very close to him in merit. Mr. Barrett's Susanna and William the Fourth were surpassed by few of the flowers exhibited. Of the exotics, the most curious was the Calceolaria Yoëngkiz, exhibited by R. Bevan, Esq. Of the fruits, the most remarkable was a noble dish of black Hamburgh grapes, from vines only three years from the eye, trained on Mr. Crawshaw's plan, and exhibited by Mr. G. Thurtell, of Mile-end Cottage, near Norwich, a non-subscriber. Mr. Marriott showed some very fine seedling nectarines. Mr. C. Thurtell of Brandon sent some onions, which surpassed the growth of the Portugal in size, but they were too late. There was a curious variety of capsicums. The celery was of immense size, but not sufficiently blanched. The honey (obtained by deprivation) was very beautiful: it was exhibited by E. Sparke, Esq.

In the course of the afternoon the Rev. E. W. Matthew called the attention of the company to

the plan of the Apiarian Society; and Mr. Payne, the secretary, reported several cases in which cottagers had received from 3*l.* to 5*l.* for the produce of their hives this year. It was stated that a market could readily be found for the pure honey in the comb, as obtained by deprivation, at the price of 2*s.* a pound. A liberal subscription was commenced for the purpose of carrying the design into effect, which requires a sum of money in the first instance for the purchase of bees, but will afterwards be kept up, it is expected, by the repayments of the cottagers. The following is the only prize of which the name of the variety gaining it is given: —

Tender plant in bloom: *Cérbera frutescens*, Mr. Wright, gardener to Lord Calthorpe. (*Bury and Norwich Post*, Sept. 14.)

Nov. 27. The fruit was remarkably fine, and very abundant. The varieties of table pears, from the garden of the Rev. Sir T. G. Cullum of Hardwick, were very justly objects of admiration; a collection of table and kitchen apples, with a dish of German medlars, and French crabs of 1829, 30, and 31, from Mr. Itay of Tostock, were also worthy of notice. The chrysanthemums were very fine, and the bouquets of tender flowers were greatly admired. Among the prizes were the following: —

Plant. Tender, in bloom in a pot, *Amaryllis psittacina*, R. Bevan, Esq.
Fruit. Plums, *Impératrice*, Mr. Barrett, gardener to Sir T. G. Cullum. — Pears. Table: 1. *Passe-Colmar*, and 2. *Beurré van Mons* (*Beurré Dieh*), Mr. Barrett. Kitchen, *Cadillac*, Mr. Stacey. — Apples. Dessert: 1. *Royal Nonpareil*, Mr. Stacey; 2. *Braddick's Nonpareil*, Mr. Barrett; Seedling, Mr. Barrett. Kitchen, *Royal Russet*, Mr. Barrett; Seedling, Mr. Steed. (*Bury and Suffolk Herald*, Nov. 30, 1831.)

Ipswich Horticultural Society. — Sept. 13. The assemblage of choice fruit and flowers was the most abundant ever before exhibited in that town. The Reporter of the *Suffolk Chronicle*, however, complains that the ladies were excluded from the dinner and dessert provided for the male subscribers. "Why," says he, "are we not permitted to obtain the benefit of their judgment on the horticulturist's labours?" Among the prizes awarded were the following: —

Plants. Green-house (in bloom in a pot): 1. *Nerium splendens*, Mr. Mills, gardener to William Rodwell, Esq.; 2. *Calceolària rugosa*, Mr. J. Smith. — Hardy: *Ipomopsis elegans*, Mr. Charles Garrod, gardener to C. S. Collinson, Esq.

Fruit. Dish of Grapes: 1. *Black Hamburgh*, Mr. George Thurtell; 2. *Sweetwater*, Mr. James Smith, gardener to D. Alexander, Esq. — Melon: 1. *Green-flesh*, Mr. J. Smith; 2. *Scarlet-flesh*, Mr. W. Turner, Ipswich. — Plums: *Coe's Golden Drop*, Mr. W. Allen, gardener to the Rev. M. Edgar. — Table Pears: *Gansell's Bergamot*, Mr. Allen. — Table Apples: *Ribston Pippin*, Mr. Garrod, gardener to R. N. Shawe, Esq. Kitchen Apple: *Hawthornden*, Mr. P. Jackson, Ipswich.

Culinary Vegetables. White Celery, Mr. Allen, gardener to the Rev. J. B. Wilkinson. Red Celery, Mr. Garrod. — Peas, *Knight's Marrowfat*, Mr. Milborn.

Cottagers' Prizes. Savoys, Mr. W. Mason, Kesgrave.
The grapes produced by Mr. Thurtell attracted particular attention; the bunches were of enormous size, and the berries exceedingly fine. We understand that his system of cultivating the vine is different from what is generally practised, and is the same as that so successfully pursued by Mr. Crawshaw of Honningham, Norfolk, who is allowed to be one of the first grape-growers in England. Of kitchen apples there was a fine display. The most remarkable were, Mr. Jackson's *Hawthornden*; Mr. Bow's *Emperor Alexander*; and Mr. Dunning of Whitton's *Seek-no-further*. (*Suffolk Chronicle*, Sept. 17.)

Oct. 6. With the exception of the georginas, the exhibition of flowers was not so good as usual; but the fruits and vegetables were equal, and in some instances superior, to any hitherto produced. The fruits, particularly the grapes and apples, which graced the table appropriated to the cottagers, attracted general attention, and were much and justly admired. Among the specimens worthy of notice were, *Black Hamburgh* grapes, and white *Cape broccoli*, sent by G. St. Vincent, Esq.; several varieties of apples and pears, by Messrs. Rednall and Bircham, nurserymen from Holton, near Halesworth; some excellent out-door grapes, by the Rev. Temple Frere, H. Browne, Esq., and T. Lombe Taylor, Esq.; and a dish of raspberries from Mr. Shipp. We cannot omit to mention how much it appears the wish of the committee to give encouragement to the cottage gardener; and, as the funds of the Society are in a healthy state, we hope to find the rewards offered to the industrious poor man increased in a twofold degree before another season is terminated.

The following is the only subscriber's prize which has the name of the variety given: — Tender Plant in bloom in a pot, *Salvia splendens*, Rev. T. Frere. Among the cottagers' prizes were the following: — Very curious *Catalash*, William Catermole, Itoydon. Skep of Honey (31 lbs.), Susan Hanton, Palgrave; of 28 lbs., — Flatman, Burgate. (*Bury and Suffolk Herald*, Oct. 12.)

Nov. 8. The following paper on the destruction of caterpillars on gooseberry bushes, from Mr. Smith, was read, and ordered to be forwarded to the Metropolitan Society: —

"Provide two semicircles of wood, sheet iron, tin, or paper, of a diameter equal to the bushes to be cleansed, in the centre of the straight line of which make a notch for the reception of the stem of the plant or plants when put under them; which being done, take of Scotch snuff one fourth, of white hellebore in powder one fourth, of lime dust one half; mix them well together, and with a common spring powder-puff apply the dust from the lower part of the bush into the habitations of the caterpillars, the strength of which will so overpower them, that they will almost instantly fall from their strongholds, apparently lifeless, into the semicircles beneath your bush; to assist which, give the stem of the bush a smart tap or two. Having cleared your bush of the enemy, take up the two semicircles, shoot the intoxicated caterpillars in a heap on the ground, crush them beneath your feet, and the work is done, except that it is advisable to cleanse the bushes afterwards with clear lime water. The above is not an expensive application; for I suppose that fifty or sixty four-year-old bushes may be cleansed in about two or three hours, and at an expense not exceeding 2*s.* I recommend the operation to be done while the caterpillars are young; for in that state their powers of defence are weak, and consequently the dust comes in easier contact with their vital parts, which causes their destruction to be more easy and effectual."

Among the prizes were the following: —

Plants. Green-house: 1. In bloom in a pot, *Maurandya semperflorens*, Mr. Block, gardener to Archdeacon Berners; 2. *Ferbasicum*, Mr. W. Allan. Chrysanthemums in bloom in a pot, Tasseled Yellow, Mr. Geo. Mills, gardener to W. Rodwell, Esq.

Fruit. Out-door Grapes: 1. *Muscadine*, Mr. W. Allen, gardener to the Rev. W. M. Edgar; 2. *Black Pince*, Mr. J. Smith, gardener to D. Alexander, Esq. — Apples. Table: 1. *Margil*,

Mr. W. Allen; 2. Golden Pippin, Dr. Beck; 3. Ribston, Mr. Milborn. Kitchen: 1. French Crab, Mr. J. Smith; 2. Beaufin, Mr. Bird; 3. Beaufin, Mr. W. Allen. — Pears. Table: 1. Crasane, Mr. W. Allen; 2. Chaumontelle, Mr. Bird. Kitchen: 1. Black Worcester, Mr. Milborn; 2. Cadillac, Mr. J. Smith.

Culinary Vegetables. Broccoli: White Cape, Mr. Milborn; Brown Cape, Mr. J. Smith. *Cottagers' Prizes.* Fruit: Blenheim Orange Apple, Wm. Vince, Elmsett. Vegetables: Savoy, John Barker, Westerfield.

Mr. Thurtell of Norwich exhibited a plate of remarkably fine Uvedale's St. Germain Pears; but was not entitled to a prize, because the number was less than the rules specify. (*Suffolk Chronicle*, Nov. 12.)

WORCESTERSHIRE.

Eresham Horticultural Society. — Oct. 13. 1831. The show of georginas and other autumnal flowers was larger and more splendid than we recollect having witnessed at this time of the year, since the establishment of the Society. The autumnal fruits of every description were so abundant, that the space on the tables was insufficient to contain them, and forms were obliged to be set out on each side of the room, as well as on each side of the centre table, for their display. After the list of prizes that had been awarded was read, the president, Edward Rudge, Esq., read a paper of Mr. Charles's of Harrington Mill, on his method of cultivating the strawberry and broccoli plants, to whom, for several years past, prizes had been awarded for the largest and best-flavoured strawberries, produced by his mode of manuring the plants, and dressing them with malt dust, as described at large in his communication to the Society. The following were among the prizes: —

Plants. Stove and Green-house: 1. *Fuchsia macrophylla*, Edward Rudge, Esq.; 2. *Erica jasmiflora*, Mr. Clarke; 3. *Mimosa sensitiva*, Edward Rudge, Esq. — Hardy Annuals: 1. *Browallia elata*, Mr. Clarke; 2. *Centaurea americana*, Mr. Hodges. — Perennials: *Astrantia major*, Mr. Balls.

Flowers. Georginas. Crimson: 1. Well's Beauté Suprême, Captain Holland; 2. Lord Brougham, Mr. Hodges. Deep Orange: *Aurántia speciosa*, Sir Charles Throckmorton. Lilac: Royal Lilac, Mr. Balls. White: Mountain of Snow, Sir Charles Throckmorton. Yellow: Le Brillant, Mr. Hodges.

Fruit. Apples. Dessert: 1. Wick Pearmain, Mr. Hodges; 2. Downton Pippin, Mr. R. Cooper; 3. Ingestrie Pippin, Mr. Hunt. Seedlings: 1. and 2. Mr. Hignall: 3. Orange Renet, Mr. Mountfort. Culinary: 1. Hawthornden, Mr. Savage; 2. Blenheim Orange, and 3. Morocco Codlin, Mr. Cooper. Cider: Black Taunton, Mr. J. Smith. — Pears: Dessert: 1. Gansell's Bergamot, Mr. Balls; 2. Brocas's Bergamot, Mrs. Ashwin; 3. Marie Louise, Mr. Cooper. Seedlings: 1. New Moorcroft, and 2. New Meadow, Mr. J. C. Wheeler. Culinary: Cadillac, Mr. Mumford. Perry Pears: 1. Oldfield, Mr. Smith; 2. Red Longdon, Mr. J. C. Wheeler. — Grapes. Outdoor: 1. Miller, Mr. Barnes; 2. Black Cluster, Mr. Balls. Red: Frontignac, Mr. Burlingham. White: Sweetwater, Mr. Day; 2. Muscadine, Sir Charles Throckmorton. — Walnuts: Early Oval, Mr. Mumford. — Cherries: Morello, Mr. Balls.

Culinary Vegetables. Carrots: 1. Early Orange, Mr. Charles; 2. the Altringham, Mr. Paine. — Onions: 1. White Spanish, Mr. W. Haynes; 2. Deptford, Mr. Charles; 3. Blood Red, Sir Charles Throckmorton. — Red Beet, Mr. Paine. — Celery. Red: 1. and 2. Mr. Balls. White: 1. and 2. Mr. Balls. — Cape Broccoli, Mr. Paine.

Extra Prizes. 1. Seedling Nut, Mrs. Ashwin; 2. *Georgina variegata*, Mr. Goodall; 3. Ash-leaved Potatoes, 16 pots on 10 square yards of ground, Mr. Wood: 4. *Cereus triangularis*, Mr. Clarke; 5. Black Rock Melon, Mr. Balls; 6. Noblesse Peach, Col. Davis, M.P.; 7. Spanish Gourd, 131 lbs. weight, Mr. Fulton. (*Worcester Herald*, Oct. 15. 1831.)

Worcestershire Horticultural Society. — Sept. 6. The following were among the prizes: —

Plants. Stove: 1. *Gloxinia maculata*, Mr. Beach; 2. *Thunbergia alata*, Mr. Tapp. — Green-house: 1. *Polygala Heisteria*, Mr. F. Brown; 2. *Fuchsia gracilis*, Mr. Cooke. — Hardy Annuals: 1. *Schizanthus pinnata*, R. Berkeley, Esq.; 2. Lemon African Marigold, Mr. Cooke. — Perennials: 1. *Lobelia fulgens*, Mr. Wood; 2. *Physostegia virginica*, Mr. Fuller. — Tender Annuals: 1. *Amaranthus*, White Globe, Sir O. Wakeman, Bart.; 2. *Browallia*, Mr. Beach.

Flowers. Georginas. Maroon Colour: 1. Tapp's Seedling, Mr. Tapp; 2. Royal Duchess, and 3. Black Turban, Mr. Beach; 4. Tapp's No. 57, Mr. Tapp; 5. Magnificent, Mr. Beach. Crimson: 1. Kuzzilbash, Mr. Tapp; 2. Hodges's William the Fourth, Mr. Hodges; 3. Tapp's Seedling, and 4. Tapp's Suprême, Mr. Tapp; 5. Jupiter, Mr. Beach; 6. Nutter's Apollo, Mr. Tapp. Purple: 1. Langlay's, Mr. Shuard; 2. Isabella, and 3. Helen, Mr. Tapp; 4. Augusta, Rev. T. Waters. Scarlet: 1. Scarlet Turban, and 2. Royal William, Mr. Tapp; 3. Sol, R. Berkeley, Esq.; 4. *Aurántia speciosa*, 5. Morning Star, and 6. Countess of Liverpool, Mr. Tapp. Sulphur: 1. Sulphurea, J. Taylor, Esq.; 2. New Dwarf Yellow, R. Nuttall, Esq.; 3. Douglas's New Yellow, Mr. Tapp. Light: 1. Theodore, Mr. Tapp; 2. *Camelliaeflora*, Mr. Shuard; 4. New Orange, Mr. Tapp; 5. *Aurántia superba*, Mr. Shuard; 6. Philip the First, Mr. Beach. White: 1. Præcellentissima, Sir A. Lechmere; 2. Mountain of Snow, Mr. Tapp; 3. Mountain of Snow, J. Taylor, Esq. — Anemone-flowering Georginas. Quilled: 1. Purple Globe, Mr. Beach; 2. Crimson Globe, and 3. Dwarf Blood Globe, Mr. Tapp. Flamed: 1. Large Crimson, Mr. Tapp; 2. Scarlet, and 3. Painted Lady, Mr. Beach; 4. Spectabilis, Mr. Tapp.

Fruit. Pines: 1. Montserrat, and 2. Queen, Mr. Wood. — Peaches: 1. Spring Grove, and 2. Royal George, A. Skey, Esq.; 3. Old Newington, Mr. Beach. — Nectarines: 1. Red Roman, J. Taylor, Esq.; 2. Scarlet, Mr. Wood; 3. Elruze, Mrs. Turner. — Grapes. Black: 1. Black Hamburg, Mr. Wood; 2. Black Hamburg, Mr. Beach. White: 1. Muscat of Alexandria, J. Taylor, Esq.; 2. Cochin China, Mr. Cooke. — Cherries: 1. and 2. Morello, Mr. Wood. — Plums: 1. Magnum Bonum, R. Nuttall, Esq.; 2. Green Gage, Mr. Cooke. — Apples. Dessert: Paradise, Mr. Cooke. Seedling: Victoria Pippin, Sir A. Lechmere, Bart. Culinary: 1. Blenheim Orange, Mr. Beach; 2. Catshead Codlin, Mr. Turner. — Pears. Dessert: 1. Jargonelle, R. Nuttall, Esq.; 2. Autumn Bergamot, Mr. F. Brown. — Nuts, Filberts: 1. and 2. Cob Nuts, Sir O. Wakeman, Bart.

Culinary Vegetables. Onions: 1. White Spanish, and 2. Silver Skin, Mr. Wood; 3. Blood Red, Sir O. Wakeman, Bart. — Celery: Red, R. Nuttall, Esq.; White, Sir O. Wakeman, Bart.

Extra Prizes. French Crabs, in beautiful perfection, of the growth of 1830, H. Newman, Esq. Honfeur Melon, grown in the open ground, under hand-glass; and Le Melon Trompe, or Trumpet Melon, from a ridge under hand-glass a foot square, J. C. Kent, Esq. (*Worcester Herald* Sept. 15. 1831.)

YORKSHIRE.

Hull Floral and Horticultural Society. — Sept. 29. The flowers and fruit were judged by Messrs. Lambert and Carr, Mr. Ely of Rothwell Haigh, and Mr. Hinsley of Henwell. The reporter observes that a taste for horticulture is daily increasing in that neighbourhood; and that the emulation excited by the Society affords a strong stimulus. Among the fruit, the apples are mentioned as particularly fine; and, among the flowers, the georginas. The following varieties are mentioned as having gained prizes: —

Georginas. White: 1. and 2. Naine Blanche, 3. Præcellentiſſima, and 4. Mountain of Snow, Mr. Woolley. Purple: 1. Imperiosa, Mr. Woolley; 2. Daphne, Mr. Bell; 3. Langley's Purple, and 4. Donna Maria, Mr. Woolley. Scarlet: 1. Bohemia, Mr. Burman; 2. Scarlet Turban, Mr. Norman; 3. Seedling, Mr. Cankrien; 4. Striped Turban, Mr. Dobson. Yellow: 1. Squibb's Pure Yellow, Mr. Cankrien; 2. Wells's Dwarf Yellow, Mr. Dobson; 3. Superb Yellow, Mr. Smithson; 4. Wells's Dwarf Yellow, Mr. Beecroft. Lilac: 1. Purpurea alata, Mr. D. Brown; 2. Royal Lilac, Mr. Woolley; 3. Queen of Roses, and 4. Royal Lilac, Mr. Percy.

Apples. Baking: Newtown Pippin (weighing 19 oz.), Mrs. Williamson of Kirkella. Eating: Ribston Pippin, Mr. Jones. (*Hull, Rockingham, and Lincolnshire Gazette*, Oct. 1.)

SCOTLAND.

Caledonian Horticultural Society. — Aug. 31. A considerable number of competitors appeared, and the articles in general were of the first-rate quality. After a careful examination, which occupied nearly four hours, the prizes were awarded as follows: —

Fruit. Three sorts of Peaches (from the open wall): New Red Magdalene, Royal George, and Noblesse, Mr. James Macdonald, gardener to His Grace the Duke of Buccleuch. Two sorts of Peaches (from flued walls): Galande and Noblesse, Mr. George Shiells, gardener to the Right Hon. Lord Blantyre, Erskine House. Two sorts of Nectarines (either from open wall, hot wall, or peach-house): Elruge and Scarlet, Mr. John Robertson, gardener to the Right Hon. Lord Gray, Kinfauns Castle. Two sorts of Plums (not generally cultivated): Caledonian Plum and Red Diaprée, Mr. James Anderson, gardener to John Bonar, Esq., of Ratho House. Three sorts of Summer Pears (Jargonelle, late Citron des Carmes, and White Beurré): Mr. James Stuart, gardener to Sir John Hope, Bart., of Pinkie. Largest Bunch of Grapes (of any variety, with the name): Nice Grape, weighing 6 lbs., Mr. G. Shiells, gardener to the Right Hon. Lord Blantyre, Erskine House. (The Committee having experienced considerable difficulty on this article, recommended that a second prize be awarded for a very large and fine bunch of the white Lombardy grape, to Mr. Daniel Cunningham, gardener to Sir Archibald Campbell, Bart., Garscube.) Largest and highest-flavoured bunch of any of the Frontignac Grapes, Mr. Archibald Reid, gardener to the Hon. Robert Lindsay, Balcarres. Largest and highest-flavoured bunch of White Muscat of Alexandria, Mr. John Kincaid, gardener to Miss Spence Yeaman of Murie. Best Otateich Pine-apple, Mr. Alexander Lauder, gardener to Colonel Harvie, Castle Semple.

Culinary Vegetables. Three different kinds of Melons (Melville, Spanish, and Ionian), Mr. William Oliver, gardener to the Right Hon. the Earl of Roslin, Dysart House. The Committee on home-made wines reported that several kinds had been produced, of excellent quality, and that the medal had been awarded for a white currant wine, made by Miss Russell, 30, Abercromby Place, Edinburgh.

The splendid exhibition of fruit, comprising two hundred and seventy-seven dishes, was in the course of the forenoon examined by a great number of persons; and among others by several of the members of the ex-royal family of France. Mademoiselle remarked, that, though it was said the sun did not shine in Scotland, there was no occasion for it, for it seemed that fruits ripened there without its rays. (*Scotsman*, Sept. 3.)

ABERDEENSHIRE.

Aberdeenshire Horticultural Society. — Nov. 2. The following were among the prizes: — To David Chalmers, Esq., of Westburn, for the best twelve Apples, Ribston Pippins, very fine. Robert Burnett, gardener to George Forbes, Esq., of Springhill, for the second best twelve Apples, Downton Pippins, very fine. William Wales, gardener to Colonel Duff, for the best twelve Pears, Swan's Egg, very fine. John Davidson, gardener to Lord Kennedy, Dunnotar House, for the second best twelve Pears, Autumn Bergamot, very fine. William Fraser, nurseryman, Ferryhill, for the best six sorts of one-year and for the best six sorts of two-year, Seedling Forest Trees. Alexander Diack, nurseryman, Mile end, for the best Seedling Apple, grown by himself. An Extra-Prize to the Rev. Dr. Morrison of Disblair, for twelve Walnuts; the tree on which they were produced was planted upwards of forty years ago. The Society's large silver medal was awarded to James Wright, Westfield, for his various superior vegetables. All the specimens at this competition were of very superior excellence, and the Show gave great satisfaction to the visitors, who generally expressed that the Aberdeenshire Horticultural Society had done more good than any other association formed within the period since it was instituted. (*Aberdeen Journal*, Nov. 9. 1831.)

AYRSHIRE.

The Ayrshire Horticultural Society held an exhibition of flowers, fruits, and vegetables, for the first time since the establishment of the Society, at Ayr, on the 8th and 9th of September, under the patronage of Lady Lillias Oswald of Auchincruive. From an ample account given of this exhibition in the *Ayr Advertiser* of the 15th of September, it appears that all the first gardens in the county contributed on the occasion. There were many fine exotics in pots, very superior pine-apples, grapes, and figs; tomatoes, ripened without a wall, from Craigie gardens; raisin des Carmes grapes, from Culzean Castle; a beautiful specimen of *Ficus elastica*, from Eglinton Castle; two very large red cabbages, weighing about 20 lbs., from Blairquhan gardens; some fine anemone and globe flowered georginas, and the *Ipomopsis elegans*, a splendid North American hardy biennial, from the nurseries of Mr. James Smith and Son, Ayr; a dish of fine cinnamon pears, from a tree supposed to be upwards of two hundred years old, presented by Dr. Mitchell of Ayr; three of the largest cockscombs ever exhibited in the county; and white cucumber and melonella from Annick Lodge. In all there were between four and five hundred dishes of fruit "of the principal and most esteemed varieties cultivated in Britain."

Among the agricultural articles exhibited were, large mangold wurtzel and bullock yellow turnips, raised from bone manure, at Fullarton, by Mr. Aiton; and large Swedish turnips, also raised from bone manure, at Holmston; and mangold wurtzel, Swedish turnip, and a very large globe turnip, raised by Mr. Tennant, at the Shields farm.

The exhibition took place in the County Hall, which was decorated in the most tasteful manner, and lighted up in the evenings, a band of music attending. Want of time prevented the practicability of a formal competition, and no prizes were of course awarded; but, as the exhibition is to be continued annually, the arrangements for next year will doubtless be more mature. (*Ayr Advertiser*, Sept. 17.)

[Knowing as we do the excellent spirit which exists among the gardeners of Ayrshire, we have no doubt that these exhibitions will be continued with increased splendour and usefulness, and we shall be happy to give them every publicity in so far as they put it in our power, by complying with our wishes, as expressed in Vol. VII. p. 626, relative to the names of the species or varieties for which prizes are given.]

EAST LOTHIAN.

East Lothian Horticultural Society.—Sept. 6. A very fine Show of the most choice and rare fruits and flowers, and an excellent competition for the following premiums:—

Flowers. Six Double Georginas, Messrs. Dods, nurserymen, Haddington. Second Double Georginas, Mr. Pearson. Two best Anemone-flowered Georginas, Messrs. Dods.

Fruit. Three sorts of Peaches (from open wall): Montauban, Early Anne, and Red Magdalene, Mr. Mathieson, gardener to Sir David Baird of Newbyth. Green Gage Plums, Mr. Arthur Calder, gardener to George Sligo, Esq., of Seaclyff. Two sorts of Summer Pears: Jargonelle and Summer Auchan, Mr. George Fowler, gardener to Sir Alexander Hope of Luffness. Largest bunch of Grapes: White Raisin, Mr. George Brown, gardener to the Earl of Lauderdale, Dunbar House. Largest and highest-flavoured bunch of White Muscat of Alexandria Grape, Mr. Brown. Largest and highest-flavoured bunch of Black Hamburg Grape, Mr. Brown. Six Moorpark Apricots, Mr. Gray, gardener to Lord Ruthven, Winton House. Melon: 1. Black Cock Melon, Mr. Alexander Cunningham, Haddington; 2. Spanish Melon, Mr. Mathieson. Green-fleshed Melon: Cephalonian Melon, Mr. Brown. Six Nectarines (of any sort): Murray Nectarines, Mr. McIntyre, gardener to Mrs. Houston of Clerkington. Six Peaches (of any sort): Noblesse Peaches, Mr. Brown. Six Figs: Brown Ischia, Mr. Pearson, gardener to the Countess of Hopetoun, Ormiston Hall.

Besides the articles sent for competition, the Society was particularly gratified with a collection of various sorts of grapes and stone fruit, sent from the garden of their president, the Earl of Lauderdale, and from Mr. Balfour of Whittingham; and also by a superb assortment of georginas, both common and anemone flowered, from Mr. Handyside, Fisherrow. (*Scotsman*, Sept. 17.)

Dec. 7. Prizes were awarded as under:—

For the highest-flavoured Seedling Apple, raised by the exhibitor, to Mr. John Ferme, Haddington. For the greatest variety of Pears of the best quality, fit for the dessert at this season, to Mr. Fowler, gardener to the Hon. Sir Alexander Hope, Luffness, for his Doyenne Gris, St. Germain, Chaumontelle, Marie Louise, Crassane, Beurré de Arcberg, Beurré d'Hiver, Beurré Blanc, Beurré Rouge, Bezi de Quesnoi, Poire d'Auch, Passe-Colaar, and Swan's Egg; thirteen sorts. For the greatest variety of Apples of the best quality, fit for the dessert at this season, to Mr. Brown, gardener to the Earl of Lauderdale, Dunbar House, for his Rambour d'Hiver, Astracan, Calville Blanche, Court pendu Gris, Reinette Rouge, Reinette Blanche, Royal d'Angleterre, Pomme de Violette, Pomme de Neige, Baltimore Pippin, Paradise Pippin, Golden Pippin, Crofton Pippin, Kentish Pippin, Nonpareil, Collector Lorimer, Downton Pippin, Ribston Pippin, Princess Noble, Kerry Pippin, Kirk's Golden Reinette, Canada Pippin, Knight's Pearmain, Woodstock Pippin, Sir Walter Blacket, Lisbon Pippin, Reinette Franche, Reinette Rouge, and Reinette Grise, thirty sorts.

Mr. Fowler also obtained a prize for the three best Pears of any variety, Marie Louise, Beurré d'Arcberg, and Brown Beurré; and Mr. Brown one for the six best heads of Celeriac, or turnip-rooted celery. A prize was awarded to Mr. Gray, gardener to Lord Ruthven, Winton House, for the best six heads of solid celery. (*Edinburgh Observer*, Dec. 13. 1831.)

FORFARSHIRE.

Dundee Horticultural Society.—Sept. 9. Among the successful competitors were the following:—

Several Fruits, the varieties not given, and also for second Muscat Grapes, Seedling Picotees, and Georginas, Mr. James Kidd, gardener, Rossie Priory. First Muscat Grapes, second Black Hamburg Grapes, and first Muscadine Grapes, Mr. John Dick, gardener, Ballindean. Seedling Apple, and Seedling and Anemone-flowered Georginas, Mr. John Walker, gardener, Airlie Castle. Green-flesh Melon, Mr. William Brow, gardener, Meigle House. Green-flesh Melon and Georginas, Mr. W. Anderson, gardener, Cortachy. Seedling Georginas, Mr. James Kettle, gardener, Glendoick. Green Gage and White Magnum Plums, Grizzly Frontignac Grapes, Syrian Grapes, variety of Grapes, Jargonelle Pears, and Seedling Carnation, Mr. Thomas Spalding, gardener, Arthurstone. Yellow Gage Plums, Black Hamburg Grapes, Grizzly Frontignac Grapes, White Muscadine Grapes, Syrian Grapes, and variety of Grapes, Mr. Alexander Smith, gardener, Connaquie. White Magnum Plums, Mr. Thomas Greig, gardener, Melville House. Fotheringham Plums, Mr. David Mitchell, gardener, Carolina Port. Jargonelle Pears, Mr. Greig, Leven. Seedling Georgina, Mr. James Smith, gardener, Ellangowan. Seedling Carnations, Mr. John Hampton. Anemone-flowered Georginas, Mr. J. Kellock, gardener, Kirkealdy.

Mr. Yeaman's prize for mangold wurtzel was gained by Mr. David Mitchell, Carolina Port. Some fine georginas were exhibited from the Scouringburn and Lilybank nurseries; a fine variety of apples from Mr. Mitchell's garden, Perth Road; some beautiful apples and pears from Glencarse; some seedling apples from Cleppington; and a large beet, weighing 7 lbs., from Carolina Port. (*Dundee Courier*, Sept. 13.)

MID-LOTHIAN.

The North Britain Professional Gardener's Society.—Edinburgh, Sept. 14. The greatest number of competitors appeared for the pear premiums, all of them exhibiting very fine specimens of the jargonelle, which is uncommonly large and beautiful this season. The first prize was given to Mr. William Watt, gardener to Lady Carnegie, Dalry House: the peaches

shown were also very fine fruit, though fewer were exhibited; but there were neither plums nor apricots sent in competition.

In the flower department the show of georginas was the finest ever exhibited in Edinburgh, both as regarded the quality of the specimens and the rareness of the varieties. A most extensive and splendid collection of georginas was sent for exhibition by the Messrs. Dickson of Leith Walk nurseries. Two plants of the scarlet cockcomb, sent from Woodhouselee garden, also attracted much attention, from the uncommon size and extreme beauty of the flowers; and a basket of the new hybrid alpine white strawberry, sent from the garden of Dysart House, had its due share of admiration, as showing that this new variety of the plant is calculated to yield that most wholesome fruit in abundance, at a period of the year much beyond the ordinary strawberry season. (*Scotsman*, Sept. 17.)

STIRLINGSHIRE.

Stirling Horticultural Society. — Sept. 9. The fruits and vegetables excited the admiration of the visitors, and in the flower department nothing could exceed the beauty and variety of the georginas; the numerous rare specimens of which evinced that the cultivation of that highly ornamental plant is rapidly gaining ground in Stirling and its vicinity. The varieties of flowers, fruit, and vegetables not being given, we omit the names of those who gained prizes; but among the many well assorted collections produced in addition to the competition parcels, the following are noticed as the most prominent and attractive:—

From Blairdrummond: Stove and green-house plants, including a beautiful specimen of *Hibiscus elegans*, standing upwards of 7 ft. high. From Tullyallan Castle: Stove and green-house plants, comprising particularly splendid specimens, correctly named. From Keir: Seedling Double Georginas, universally admired. From Buchanan gardens: superior Figs, Onions, and Mangold wurtzel, some of the latter roots weighing upwards of 10 lbs. From Craigforth: Cacti, Fruited Egg Plants, and Gourds of uncommon size. From Mr. Christie, Causewayhead: a *Nerium splendens*. From Boquhan: Squashes and Gourds, one of which was remarkable for size, having weighed 56 lbs.; and there is little doubt that, if it had not been cut so early, it would have added considerably more to its weight. It is a curious fact, that it was ascertained to have grown, for seven weeks, at the rate of 8 lbs. per week. This gourd was of a globular shape. From Airthrey Castle: some immense Tomatoes and very superior Peaches. From Woodlands, near Glasgow: a Netted Melon, weighing 15 lbs. From Dollar Botanic Gardens: a bouquet of named Ericas, &c. From Cadder House: a box of peculiarly rich Double Georginas. From Powis: a basket of Fruit, including some handsome Cucumbers, 5 lbs. each. From Callander Park: Green-house and Herbaceous Plants, comprehending six new varieties of *Pentstemon*; four beautiful hybrid varieties of *Salpiglossis*; *Passiflora alata*; Cockscoums; also very large hot-house Peaches, &c. From Mr. Neilson, Buchlyvie: a plant of Cobbett's Corn in full ear. From Ardoch House: Double Scarlet Nasturtium and *Fuchsia microphylla*. From Messrs. Drummond's nurseries: Double named Georginas, fifty select varieties, chiefly new dwarfs; a Stirling Castle Apple Tree, lately raised from seed, and loaded with large finely formed fruit; also Pumpkins, Vegeta de Marrow, Green-house Plants, &c. From Mr. Kay, Shiphaugh: a Tree or Cow Cabbage, 5 ft. high and 18 ft. in circumference: this giant succulent being stationed on the terrace of the adjoining bowling-green, and surrounded by enormous competing savoys and German greens, formed a most imposing group. (*Stirling Advertiser*, Sept. 9.)

Dec. 9. The circular of articles to be compiled for, and prizes to be awarded, for the year 1832, which has been sent to us, proves this Society to be in a very flourishing state; and of the competing gardeners, it has been stated to us, that, though the prizes are small, the spirit displayed in contending for them is great. All that is wanting is a little more encouragement from the country gentlemen. We observe that a prize is offered to apprentices for the best plan for two ranges of melon pits. This is good. We should also like to see prizes offered to apprentices for the best written article on any professional subject. Gardeners are by no means aware how much of their success in life depends upon the sort of letter which they can write to a gentleman, when they either apply for a situation, or answer an application made to them. We can assure them, that, in nine cases out of ten, their success depends entirely on the sort of letter they may write. Their after success depends on their conduct and professional knowledge; but we repeat, that their having an opportunity of displaying that conduct and knowledge depends on their talent in letter-writing. We wish young gardeners were as fully aware of this fact as we are ourselves. They would then give their best hours of leisure to English grammar. We earnestly recommend to them what Cobbett has said on this subject in his *Advice to Young Men*, ¶ 44. & 45. No master, worthy of respect himself, ever treated a servant disrespectfully who could write well, and converse sensibly.

IRELAND.

ANTRIM.

Belfast Horticultural Society. — Sept. 6. The display of fruit, flowers, and vegetables was truly grand, embracing some of the finest specimens, and in the greatest variety, we have ever witnessed in this part of the country. It is truly gratifying to find that this Society, so recently established as to be yet almost in its infancy, has arrived at such a degree of perfection; and we understand it is greatly on the increase. The room was decorated in the most tasteful and elegant manner with flowers, evergreens, &c. At one end of the room there was a beautiful flower-woven arbour, in which was placed a chair of state for the Marchioness of Donegall; and at the opposite end was the orchestra, occupied by the Marquess of Donegall's fine band.

Prize for the best Georgina (seedling, from Irish seed, saved in 1800), to Mr. John Scott, gardener to the Marquess of Donegall, at Ormeau. The other prizes, not mentioning the varieties, are not inserted. (p. 625.)

ART. XII. Horticultural Society and Garden.

Nov. 1. 1831. — The following medals having been awarded to successful competitors at the different public exhibitions to which contributions had been invited by the council, the list was read: —

The Banksian medal to Mr. James Young, for his exhibition of upwards of 400 sorts of roses, on June 21. The large silver medal to Mr. Joseph Wells, for a collection of Georginas exhibited on Sept. 6. The Banksian medal to Mr. C. Brown, for Georginas exhibited on Sept. 6. The Banksian medal to Mr. John Wells, for his exhibition of Georginas on Sept. 6. The Banksian medal to Edmund Tattersall, Esq., for Grapes exhibited Sept. 20. The Banksian medal to John Allnutt, Esq., for Grapes exhibited Sept. 20. The Banksian medal to the Earl of Caernarvon, for Azaleas exhibited June 7. Banksian medals, it was announced, had also been awarded to Mr. Joseph Myatt, for strawberries exhibited July 5.; to Mr. Hugh Fraser, for various fruits, and particularly for a very fine specimen of the Gerger melon, exhibited Sept. 6.; and to Mr. James Veitch, for Georginas exhibited Oct. 18.

Read. An account of the Black Constantia grape; by the Earl of Tyrconnel. An account of the Muscat Eshcollata grape; by Mr. Daniel Money.

Exhibited. St. Germain pears, from Mr. G. Watson, gardener to Lord Palmerston. White Corinth grapes, Alfriston and Reinette de Canada apples, from H. Pownall, Esq. Beurré Diel pears, golden pippins, green or royal nonpareils, from T. Hunt, Esq. Specimens of the Muscat Eshcollata grape, from Mr. D. Money. A very fine specimen of *Cypripedium* insigne from Messrs. Rollisson.

Also, from the Garden of the Society. Flowers. *Verbena chamædrifolia*, *Stèvia purpurea*, *Cælestina suffruticosa*, *Potentilla nepalensis*; *Sálvia pseudo-coccinea*, *Grahàmi*, splendens, fulgens; *Fúchsia virgata*, microphýlla; *Chrysanthemums*, Parks's small yellow, Early blush, Tasseled yellow, Old purple, Buff or orange; Georginas. — Fruit. Pears: Duchesse d'Angoulême, Napoleon, Beurré d'Aremberg, Bézi de la Motte, Glout morceau, St. Germain; Doyenné blanc, Doyenne gris; Gendeseim, Crassane, Beurré diel, Bergamotte calet. Most of these were put in sand, and it has had the effect of ripening them sooner than those left on the open shelves. This must be accounted for by the temperature of the sand at that early period being warmer, and still retaining the summer heat better than the external air. The reverse is the case when the sand once becomes thoroughly cooled in winter; and, by its steadily remaining so, the fruit then keeps longer. — Eighteen sorts of apples from Mr. John Whiting, Weobley, Herefordshire; those named the King of the pippins, but called in that place the Orange pippin, were very fine specimens.

Nov. 15. — *Read.* A paper on the Result of some Experiments upon the Growth of Potatoes, tried in the Garden of the Society in the year 1831; by J. Lindley, Esq. F.R.S. &c., Assistant Secretary.

Exhibited. Fruit of the Service tree, from Sir Henry Willock. Specimens of *Arbutus Uredo*, with fruit in different stages and blossoms, from Edmund Storr Haswell, Esq. The Antigua queen pine-apple, from Mr. G. Mills.

Also, from the Garden of the Society. Flowers. *Chrysanthemums*: Small yellow, Park's small yellow, Two-coloured red, Tasseled yellow, Buff or orange, Rose or pink, Pale buff, Spanish brown, Golden yellow, Golden lotus-flowered, Old purple. *Málva purpurata*, *Alstromèria acutifolia*. — Vegetables. Kohl Rabi: Transparent or glass (purple), do. (green), London's Kale, Artichoke-leaved (purple), do. (green). — Fruit. Pears: Chaumontel, Napoleon, Gendeseim, Doyenné gris, Bézi de Montigny,

Messire Jean, Duchesse d'Angoulême, Passe-Colmar. From T. Hunt, Esq. : Beurré diel pear, Hunt's royal nonpareil apple, Golden pippin apple. From T. A. Knight, Esq. : Seedling pear, No. 2. (from a wall and from a standard). From Harry Dobree, Esq. : Seedling swan's egg pear; scarcely so good as the swan's egg. Chile Peppers: Yellow tree capsicum, Red Chile, Small red Chile, Tree capsicum, Piment longue petit tardif, Long Chile, from the East Indies, Long Chile, Long red Chile, Black Chile, Piment violet, Indian small red, Cayenne pepper. Capsicums: Long small yellow, Long yellow, Woolly-leaved; Piment long petit à feuille étroite, do. cornu, do. café; Capsicum annuum, Large long yellow, Bell pepper, Piment gros long about, do. de pimentos, do. ordinaire, Capsicum paprika, Short red, Piment cerise, do. de pimentos, do. carre doux, do. gros long about, do. cerise petit; Tall cherry red, Small cherry yellow, Upright yellow, Unnamed, Boston pepper, Oval yellow, Small yellow, Cerise gros, American bonnet pepper, Red tomato.

Dec. 6. — Read. A Report from the Garden of the Society upon the Propagation of Cabbages by Slips; by John Lindley, Esq. F.R.S. &c., Assistant Secretary. The second edition of the Catalogue of Fruits cultivated in the Society's Garden having issued from the press, it was announced as being ready for delivery to the Fellows of the Society, at the price of 5s. per copy.

Exhibited. Very fine two-coloured, incurved, and brown purple chrysanthemums, from William Wells, Esq. A remarkably well-blown plant of the double yellow Indian chrysanthemum, from L. Weltje, Esq. A potiron jaune [large yellow mammoth gourd], weighing 153 lbs., from the garden of the Rev. H. Wise, Offchurch, near Leamington; presented by Mr. Carpenter. This was one of a crop weighing altogether 555 lbs. from the same vine. Forbidden fruit, from the West Indies, presented by H. M. Dyer, Esq. A pear, Uvedale's St. Germain [?], weighing 3 lbs. 2 oz., from the garden of Mrs. Chambers of Feversham, communicated by J. R. Neame, Esq. Newtown pippins, from the garden of William Haldimand, Esq. : these, on examination, proved to be the Fall pippin. Seedling pears and seedling potatoes, from John Harrison, Esq., Snelstone Hall, near Ashbourne.

From the Society's Garden. Flowers. Chrysanthemums: Park's small yellow, Semidouble quilled white, Tasseled white, Pale buff, Pale pink, Changeable white, Tasseled yellow, Two-coloured red, Golden lotus-flowered. — Fruit. Pears: Bon Chrétien Ture, Passe-Colmar, Crassane, Gloux morcean, Napoléon, Gendescim, Chaumontel, Josephine, Beurré diel, Bergamotte cadet, Saint Germain, Easter beurré. Seedling Chaumontel pear and Swan's egg do., from H. Dobree, Esq. Duchesse d'Angoulême pear, Bézi de la Motte do., and Poire de Naples, from M. Langelier.

Dec. 20. — Read. A Paper on the beneficial Effects of the accumulation of Sap in Annual Plants; by T. A. Knight, Esq. F.R.S. &c., President.

Exhibited. Chrysanthemums, Camellias, and a flower of *Banksia æmula*, from William Wells, Esq. Among the Camellias were some fine flowers of the Greville red. Nine sorts of Camellias, from Messrs. Chandler. Genuine Newtown pippins, and a specimen of a Chinese pruning-knife from John Reeves, Esq. Two baskets of very fine Camellias, from John Allnutt, Esq. Double Indian yellow Chrysanthemums, and do. white, from Mr. James Young.

Also, from the Garden of the Society. Flowers. Double white Indian Chrysanthemum; *Chimonanthus fragrans* var. *grandiflorus*. — Fruit. Pears: Beurré d'Arenberg, Bon Chrétien Ture, Dowler's seedling, Nelis d'Hiver, Glout morcean, Beurré diel, Easter beurré, Passe-Colmar.

Jan. 3. — Read. An account of the Horsforth seedling Vine; by Mr. Thomas Appleby.

Exhibited. Horsforth seedling Grapes, from Mr. Thomas Appleby. A seedling Pine-apple, from Mr. D. Money. Some flowers, and the fol-

lowing kinds of *Caméllia*, from Messrs. Chandler and Sons, Vauxhall; Chandleri, *althæiflora* (two plants), concinna, Gray's *Rosa mundi*, Press's single white, Press's striped, and Aitoni.

Also, from the Garden of the Society. Fruit. Pears: Bon Chrétien Turc, Passe-Colmar, Glout morceau, Bézi Vaet, Colmar Josephine, Easter Beurré. — Flowers: Chimonáthus frágans var. grandiflorus.

ART. XIII. Covent Garden Market.

<i>The Cabbage Tribe.</i>		From	To	<i>Pot and Sweet Herbs.</i>		From	To
		£ s. d.	£ s. d.			£ s. d.	£ s. d.
Cabbages, per dozen :				Parsley, per half sieve	-	0 1 6	0 2 6
Red	-	0 2 6	0 4 0	Fennel, per dozen bunches	-	0 1 0	0 0 0
Plants, or Coleworts	-	0 2 0	0 3 0	Thyme, per dozen bunches	-	0 2 6	0 0 0
Savoy	-	0 0 6	0 1 0	Sage, per dozen bunches	-	0 2 6	0 0 0
Brussels Sprouts, per $\frac{1}{2}$ sieve	-	0 1 0	0 1 9	Mint, dried, per doz. bun.	-	0 1 6	0 0 0
German Greens, or Kale	-	0 0 9	0 0 0	Peppermint, dried, per doz. bunches	-	0 2 6	0 0 0
Broccoli, per bunch :				Marjoram, per doz. bunches	-	0 1 0	0 0 0
White	-	0 1 0	0 2 6	Savory, per doz. bunches	-	0 3 0	0 0 0
Green	-	0 1 0	0 1 6	Basil, dried, per doz. bun.	-	0 1 6	0 0 0
Purple	-	0 1 0	0 1 6	Rosemary, Green, per dozen bunches	-	0 4 0	0 0 0
<i>Legumcs.</i>				Lavender, dried, per dozen bunches	-	0 2 0	0 0 0
Kidneybeans, forced, per hundred	-	0 3 0	0 4 0	Tansy, dried, per dozen bunches	-	0 1 0	0 0 0
<i>Tubers and Roots.</i>				Mint, forced, per bunch	-	0 0 6	0 1 0
Potatoes	$\left\{ \begin{array}{l} \text{per ton} \\ \text{per cwt.} \\ \text{per bush.} \end{array} \right.$	$\left\{ \begin{array}{l} 3 0 0 \\ 0 3 0 \\ 0 1 6 \end{array} \right.$	$\left\{ \begin{array}{l} 5 0 0 \\ 0 5 0 \\ 0 2 6 \end{array} \right.$	<i>Stalks and Fruits for Tarts, Pickling, &c.</i>			
Kidney, per bushel	-	0 2 0	0 2 6	Rhubarb Stalks, per bundle	-	0 2 0	0 2 6
Scotch, per bushel	-	0 1 9	0 2 3	<i>Edible Fungi and Fuci.</i>			
Jerusalem $\left\{ \begin{array}{l} \text{per half sieve} \\ \text{per dozen} \end{array} \right.$	-	$\left\{ \begin{array}{l} 0 1 3 \\ 0 0 3 \end{array} \right.$	$\left\{ \begin{array}{l} 0 1 6 \\ 0 0 6 \end{array} \right.$	Mushrooms, per pottle	-	0 0 9	0 1 6
Artichokes	-	0 0 3	0 0 6	Morels, dried, per pound	-	0 12 0	0 0 0
Turnips, White, per bunch	-	0 0 2	0 0 3	Truffles, per pound :			
Carrots, per bunch :				English	-	0 5 0	0 0 0
Old	-	0 0 4	0 0 6	Foreign	-	0 14 0	0 0 0
Horn	-	0 0 6	0 0 8	<i>Fruits.</i>			
Parsneps, per dozen	-	0 0 9	0 1 0	Apples, Dessert, per bushel :			
Red Beet, per dozen	-	0 0 9	0 1 3	Nonpareils	-	2 0 0	2 10 0
Skirret, per bunch	-	0 0 9	0 2 0	Reinette grise	-	1 4 0	1 10 0
Scorzonera, per bundle	-	0 1 0	0 1 3	Apples, Baking, per bushel	-	0 6 0	0 7 0
Salsify, per bunch	-	0 1 0	0 1 3	American	-	1 10 0	0 0 0
Horseradish, per bundle	-	0 2 6	0 5 0	French	-	0 6 0	0 8 0
Radishes :				Royals	-	0 8 0	0 0 0
Red $\left\{ \begin{array}{l} \text{per dozen bands (24} \\ \text{to 30 each)} \end{array} \right.$	-	0 1 0	0 1 6	Pearmain	-	0 8 0	0 10 0
<i>The Spinach Tribe.</i>				Pears, Dessert, per $\frac{1}{2}$ sieve	-	1 10 0	2 0 0
Spinach $\left\{ \begin{array}{l} \text{per sieve} \\ \text{per half sieve} \end{array} \right.$	-	$\left\{ \begin{array}{l} 0 1 6 \\ 0 0 9 \end{array} \right.$	$\left\{ \begin{array}{l} 0 0 0 \\ 0 1 0 \end{array} \right.$	Colmar, per dozen	-	0 8 0	0 10 0
Sorrel, per half sieve	-	0 1 6	0 0 0	St. Germain	-	0 6 0	0 12 0
<i>The Onion Tribe.</i>				Bon Chrétien	-	0 4 0	0 6 0
Onions, Old, per bushel	-	0 4 6	0 5 0	Chaumontel	-	0 6 0	0 8 0
For pickling, per $\frac{1}{2}$ sieve	-	0 3 0	0 5 0	Baking, per half sieve :			
Green (Ciboules), p. bun.	-	0 0 2	0 0 3	Eudet St. Germain, per dozen	-	0 6 0	0 9 0
Leeks, per dozen bunches	-	0 1 3	0 1 6	Cadillac	-	0 0 0	0 3 6
Garlic, per pound	-	0 0 9	0 0 0	Almonds, per peck	-	0 7 0	0 0 0
Shallots, per pound	-	0 0 10	0 1 0	Cranberries, per gallon	-	0 3 0	0 4 0
<i>Asparaginous Plants, Salads, &c.</i>				Walnuts, dried, per bushel	-	0 16 0	0 0 0
Asparagus, per hundred :				Chestnuts, French, per peck	-	0 3 0	0 10 0
Large	-	0 6 0	0 9 0	Pine-apples, per pound	-	0 5 0	0 8 0
Middling	-	0 2 0	0 3 6	Grapes, Hot-house, per pound	-	0 8 0	0 10 0
Small	-	0 1 6	0 2 0	Cucumbers, frame, p. brace	-	0 10 0	0 0 0
Seakale, per punnet	-	0 1 0	0 3 0	Oranges $\left\{ \begin{array}{l} \text{per dozen} \\ \text{per hundred} \end{array} \right.$	-	$\left\{ \begin{array}{l} 0 0 9 \\ 0 3 6 \end{array} \right.$	$\left\{ \begin{array}{l} 0 2 0 \\ 0 16 0 \end{array} \right.$
Lettuce, per score :				Bitter, per hundred	-	0 6 0	0 12 0
Cos	-	0 1 3	0 0 0	Lemons $\left\{ \begin{array}{l} \text{per dozen} \\ \text{per hundred} \end{array} \right.$	-	$\left\{ \begin{array}{l} 0 0 9 \\ 0 4 0 \end{array} \right.$	$\left\{ \begin{array}{l} 0 2 0 \\ 0 14 0 \end{array} \right.$
Cabbage	-	0 0 0	0 0 6	Pomegranates, per dozen	-	0 4 0	0 6 0
Endive, per score	-	0 1 6	0 2 6	Nuts, per peck :			
Celery, per bundle (12 to 15)	-	0 0 4	0 1 6	Spanish	-	0 6 0	0 0 0
Small Salads, per punnet	-	0 0 2	0 0 3	Barcelona	-	0 6 0	0 7 0
Watercress, per dozen small bunches	-	0 0 4	0 0 6	Hicory	-	0 5 0	0 0 0

Observations. — Up to the present period we have had so little frost as to occasion no interruption to the full and regular supply of the market with every article in its usual season, and very little change in price has taken place. On the whole, a good, but not a large, supply has come to hand, at a very moderate rate.

The same depression which has so much affected business generally has had great influence on the prices in our market. Additional effect has been produced, and continues to prevail, respecting salads and other raw vegetables, as tending to dispose to cholera, &c.; but as the apprehension is decreasing, it is much to be wished that the usual demand may exist as the spring approaches, otherwise the most serious loss to the cultivators will ensue.

Broccolies, of many varieties, and of excellent quality, have been furnished in large quantities, and at very moderate prices. Brussels sprouts are getting generally into use, and are sought after: in a few years they will, I have little doubt, supersede the coarser but more prevalent varieties of borecoles and German greens. Coleworts have been of excellent quality and in good supply, not having as yet been affected by frost. Savoys have been plentiful and good, at a moderate price. The larger variety of cabbage, called drumhead, or, vulgarly, cow or cattle cabbage, has been occasionally brought, and met with ready sale, not from any scarcity of other sorts, but, from having been persevered in, the public are better acquainted with its good qualities. Onions have maintained a uniform price throughout the season: the supply ample, but not abundant. Turnips are of excellent quality, and moderate in price, with a steady and as yet a regular supply; and, as there is no appearance of frost setting in at present, no doubt the supply will continue good throughout the winter. Carrots have been plentiful and good; and, from the recent introduction of the Altringham variety, with an extensive growth of the long orange or Surrey carrots, a large supply is constantly kept up. By the means of the short orange and the early horn, carrots are to be found in our markets in good condition throughout the year. Notwithstanding the supply, fair prices have been obtained. All other vegetables have been furnished liberally, but I fear the prices are not such as to afford encouragement to the growers, who are materially affected by the total failure of their winter fruit crops in the last season.

Despite of the very general, in many places total, failure of the apple crop last season, we have had an ample supply from the Continent at very moderate prices. Some of the better varieties, which are scarce, are dear; but in the ordinary run of goods, which are alone calculated to meet an extensive demand, the duty and charges of import must operate very seriously on the profits accruing to the importers. Some few American apples have also been imported; but, in consequence of the delay in the vessels getting into the river, they seldom reach us in good condition. The favourite variety, the Newtown pippin, is almost the only one which will bear the temperature of the voyage for four or six weeks, which is usually the time occupied. The better varieties of pears, which are seldom plentiful, have this season (with all other sorts) been scarce and dear. But few of the newer French sorts are as yet in such general culture in the gardens as to supply the market; and few of them will, I think, be equal in flavour to our old established favourites. [This opinion of our correspondent is at variance with that of Mr. Thompson, the superintendent of the fruit department in the Horticultural Society's garden, and with our own.] — *G. C. Jan. 17. 1832.*

THE
GARDENER'S MAGAZINE,

APRIL, 1832.

ORIGINAL COMMUNICATIONS.

ART. I. *General Results of a Gardening Tour, during July, August, and part of September, in the Year 1831, from Dumfries, by Kirkcudbright, Ayr, and Greenock, to Paisley.* By the CONDUCTOR.

(Continued from p. 5.)

IN the introduction to the preceding portion of our tour, we strongly recommended to young gardeners to prepare themselves for filling the situation, not only of a head gardener, but also that of a general manager on a gentleman's estate. We see every day more and more occasion for giving this advice; and we are happy to find it followed up by two very intelligent correspondents in the present Number (p. 134. and p. 137.). Mere gardening, whether as a commercial pursuit by nurserymen and florists, or as a personal and professional service, never was, at any time within our recollection, at so low an ebb as it is at present. Nurserymen are becoming bankrupts all over the country, and there can be no doubt that many of them, whose names are not gazetted, have been obliged to compound with their creditors. So many master gardeners out of place, and journeymen in want of employment, we have never before seen about London: in the nurseries, which formerly used to be a sort of asylum for them, they cannot now find employment even at 12s. a week. That this state of depression will be followed by a reaction, and that at no distant period, is to be expected, because action and reaction are always reciprocal; but that either the nursery busi-

ness, or the profession of a gentleman's gardener, will ever be again what it has been, appears to us clearly impossible.

In the first place, with respect to nurserymen, the knowledge of all the best methods of propagation is now so generally diffused, and thereby rendered so easy, that every gentleman's gardener, having once obtained a new plant, propagates it for himself, his neighbours, and his master's friends. This reduces the business of the nurseryman, as far as new plants are concerned, to the profits which he may make during the first three or four years after the new plant is come into his possession. Let a new plant once find its way into twenty or thirty private collections, and unless it is one of extraordinary popularity, such as the pelargonium, the camellia, and a few others, the nurseryman may discard it for ever from his stock. For fruit trees there will always be a demand; because, as long as houses are built or repaired, gardens will continue to be made or altered: but the propagation of fruit trees is now become so general, that it affords very little profit, except to nurserymen in the country, who pay low rents for their land. The rage for forest planting, which prevailed some years ago, when corn and timber were at war prices, and gentlemen consequently full of money, has subsided; and hence the millions of seedling larches, and of Scotch pines, which are raised in the nurseries in Aberdeenshire, at Perth, and at Kilmarnock, are either burned on the spot, or sold at little more than sixpence a thousand. Well dried, and made into small bundles, these seedlings would bring more money in London for the purpose of lighting fires. In short, capital employed in the nursery business returns at present perhaps less than capital employed in any other trade. It once returned more, but the reason why it did so no longer exists; viz. the enjoyment of a monopoly by the nurserymen in the article of skilful propagation of plants. That monopoly is now gone for ever, as other monopolies have gone, and as all will go.

The profession of a gentleman's gardener will never be what it has been, for this simple reason, that his employer is no longer, and never will be again, what he once was.

The higher classes, feeling themselves obliged to retrench, though they will never be able to do without gardeners, will yet learn to dispense with those departments of the profession which are more especially luxuries; and the gardener will be required to extend his management to the woods, or to the farm, or to both. He will, at the same time, while acting in the united capacity of gardener and bailiff, find it requisite to possess more botanical knowledge than he does at present;

because, as the higher classes get poorer, they will live more upon their own estates, and enter more and more into country pursuits. They will give up forcing various sorts of fruit and vegetables, so as to have them ripe at unnatural seasons, when their only value consists in the difficulty and expense attending their attainment; but every country seat will have its arboretum, and herbaceous ground, and there will be no end to the number of representative systems of hardy plants. As the attention of landed proprietors, and particularly that of their wives and daughters, will be now more exclusively directed to botany, and other branches of natural history, they will obviously require from their gardeners more knowledge in these sciences. That they will find persons possessing this knowledge, and, at the same time, obtain from them a more varied and more extended description of service, we have not a doubt; because the situation of head gardener, or general manager of an estate, is too comfortable a one not to produce abundance of candidates, with whatever degree of skill for which there may be a demand. In respect to wages, though these may be nominally smaller than at present, they will always be such as to command at least as many of the comforts and conveniences of life as gardeners now enjoy; most probably more.

Our object, in making these remarks, is to prepare the minds of gardeners for the comparatively new state of things which they will find gradually coming upon them. The young and scientific have nothing to fear; every year their value will be better and better understood: but the young, whose education has been neglected, and the grown-up gardener, who belongs to what may be called the old school, may henceforth both lay their account with falling rather than rising in the world.

We have always strongly recommended to gardeners, whether informed or uninformed, to emigrate to America or Australia, rather than remain in this country; but we more especially recommend this measure to the last class. If they can only raise as much money as will pay their passage to New York (5*l.* per head, the party providing food and clothes), or to Sydney (30*l.* per head, including food on the voyage), they will be certain of finding employment, as common labourers, at from 4*s.* to 5*s.* a day in both these parts of the world; while the price of excellent food and lodging does not exceed a shilling a day in either. After working a few years, as much may be saved as will enable the party to retire to the back woods of the United States, or the bush of New Holland or Van Diemen's Land, and to purchase a farm of 200 or 300 acres. Let no gardener, how-

ever, emigrating to either America or Anstralia, reckon on being employed in any other capacity than as a common labourer; and let him make up his mind, in the former country at least, to work much harder than he has ever been accustomed to do in Britain, and to meet with fellow-labourers who will generally be found his superiors in every description of knowledge except that of gardening. — But we are forgetting the title to this article.

In our last (p. 5.) we concluded with some general remarks on the gentlemen's seats of the west of Scotland, and we shall now offer a few observations on some of their details.

The Fences in the Parks and Pleasure-Grounds of the West of Scotland are in many cases very offensive to the eye, from a variety of causes, but chiefly from having been treated as objects to be looked at, rather than as temporary barriers; in short, from being considered as the end, instead of being only the means. We do not speak of permanent fences, such as the outer boundaries of parks, but of those formed round young plantations in their interior, to protect the trees till they are large enough to be no longer in danger from cattle. The fence is, in all such cases, obviously a temporary expedient, and should never, therefore, exhibit the appearance of having had much labour bestowed upon it. It should not be of a kind very conspicuous to the eye, or even seemingly very impenetrable as a barrier, or of a very durable material. There are other principles which enter into the consideration of the subject of fences, such as their outline, and the influence upon the fence of the manner of treating the trees enclosed by it.

The two prevailing fences in the district in question are the hawthorn hedge and the stone wall; both the very worst that could be employed in a park or pleasure-ground, as presenting all the opposite qualities to those which are desirable in a temporary fence. The thorn hedge, when left to itself, grows too large, and when carefully clipped, as it most commonly is, it exhibits an appearance of care and labour not in accordance with the idea of temporary purpose. Bad as the stone wall is, it is, however, when built of loose stones, without mortar, not so offensive as the clipped hedge; because it is neither so large, nor so lumpish in form, nor so monotonous in colour. Still, both these fences are utterly inadmissible, in our opinion, as temporary enclosures in a park; nor can there be any occasion to resort to them, now that the thinnings of plantations may be had all over the west of Scotland at a very low price. These thinnings, or small fir trees, cut in lengths of 5 or 6 ft., inserted in the ground with their bark on, and

connected together by a rail, also with the bark on, within a foot or 18 in. of the top, form one of the cheapest and best temporary barriers, and one which can only be surpassed by hurdles, or by a light iron fence.

But the evils of hedges or walls, as temporary fences, in the district alluded to, are greatly aggravated by the manner of managing the trees within, and by the outline or ground plan of the plantation. The outline is not sufficiently varied of itself, and the clump or mass is most frequently isolated, and unconnected with any thing else. The outline of the belt is generally not less formal than that of the clumps; and what we particularly object to in both is, that they are crowded with trees, so as to present one lumpish opaque mass of foliage, without any appearance of trunks or branches. The trees enclosed ought not only to be thinned every year from the time of planting, as they advance in size, but those left ought to stand in groups, leaving large blank spaces within the fence, covered only with grass, or with furze, ferns, or such like low growths. This would lessen the deformity of clumps, or belts, with formal outlines, whether of hedges or walls; but with suitably varied outlines much less trouble would be necessary in breaking the masses into groups, and none, or very few, naked spaces need be left within the enclosure. Fences of pales, laid out in irregular lines, with the trees within grouped, but not crowded, the trees retiring from the fence when recesses occur in its line, and boldly advancing to it when the line stands forward, the trees every where so thin as to show their trunks, arms, and branches, will never produce a disagreeable effect; on the contrary, the apparent cooperation of purpose between the fence and the trees will be felt as a species of positive beauty. Judging from what is almost every where met with in the west of Scotland, however, there is very little feeling for any kind of beauty connected with park scenery. We ought to except Munches, Closeburn, and perhaps some parts of St. Mary's Isle: but who could tolerate the hedged clumps, and lumpish unconnected masses of thick heavy plantation, in the otherwise fine park at Cally? What has been done at Munches evinces the greatest judgment; and, indeed, we met no man in Scotland so entirely of our own mind, in matters of taste, as the Reverend Mr. Carruthers of Dalbeattie, by whose assistance Munches was laid out.

If the same money which has been spent in planting hedges, and clipping them afterwards, had been laid out in trenching the ground previously to its being planted, and in thinning out the trees in due time; instead of clumps and belts of the most offensive formality, in many cases so crowded with trees

as to be alike devoid of beauty and utility, as at Culzean Castle, for example, we should by this time have had open, airy groups of large trees, without fences, in the interior of parks; and round them marginal woods of trees, twice the size they now are.

(*To be continued.*)

ART. II. *Remarks on the depressed State of the Nursery and Gardening Professions, more especially in Scotland.* By J. G.

DURING the last twenty years, nurserymen have increased with a rapidity never before equalled. Even in the most remote districts of Scotland, where only the shadow of a living presented itself, nurseries have been established; and they are actually to be found scattered over the whole land. They are, however, at present, very badly encouraged. Of the many millions of seedlings raised annually, very few are transplanted to permanent situations; and this is more to be regretted, when we look upon the state of the country, and see how much might be effected by planting. There are, in Scotland, many thousands of acres of land well adapted for growing any species of hard wood lying idle; and there are many places that might be particularly pointed out, which, if planted, would not only beautify but enrich the country.

Perhaps there is no district, possessing such a limited degree of commerce, in which nurserymen are so thickly situated, as in that line of country which embraces the shires of Aberdeen, Banff, and Elgin. About twenty years ago, the trade in this quarter was profitable, because it was in the hands of a few; but no sooner had the number of nurserymen increased, than the prosperity of the profession began to wane. Year after year they have been anticipating a favourable change; but, instead of any occurring, during the last ten years particularly, their business has been gradually decreasing, till it is now reduced to a degree never before known. It might be thought that nurserymen must prosper as long as the country in which they reside presents ample room for the operation of the planter; but the present state of things shows that their increase has not been attended by a corresponding quantity of waste land being planted, and that it is quite possible the profession may almost cease to exist, though the half of the country remains wild and bare.

The causes of this depression are manifold: nurserymen, as I have said, have become more numerous, without a corresponding increase of traffic; the times generally are in a state which forbids landholders to invest much capital in planting; and

those noblemen and gentlemen who do continue to improve their grounds in this manner, have very generally adopted the plan of forming nurseries for themselves. This last cause affects nurserymen most; and, if upheld, will ere long render them useless. To remedy this, it is only necessary, I think, that proprietors should keep a minute account of the expense of their nurseries: for I am persuaded such departments are kept up at a considerable loss; and the reason why this practice has not been discontinued is, because no correct notice is taken of the expenditure. They imagine, that, since they pay no rent, their gardeners or foresters can rear plants cheaper than they can purchase them: but if they take into consideration the time expended in sowing, weeding, transplanting, &c., which should be appropriated by those who hold either of these offices to employments more closely connected with their respective businesses, they will find that (especially in these times, when the multiplicity of nurserymen is a pledge against their being overcharged) it is quite superfluous to keep up nurseries for themselves.

In the northern districts of Scotland, the trade consists principally in growing the leading kinds of forest trees; and of course it is easier injured than one more varied. The first dependence is upon landed proprietors, for no one else requires any quantity of hardwood; and so soon as they withdraw their aid, the nurserymen are left with a useless stock upon their hands. In this respect, they are much more depressed than their brethren in the more populous districts; the trade of the latter being more general, and consequently less dependent upon a few patrons.

Whether or not there will ever be a revival in this useful profession, is a question highly problematical. Past experience knew not such a stagnation. If we look upon the increasing mortgages on land in Scotland, weighing so heavily upon the spirit of improvement, the future becomes gloomy.

The gardening profession is likewise at a low ebb: but not so low as to prevent those who have a proper degree of information from finding comfortable situations. A majority of the gardeners of the present day rest contented with the acquisition of mere horticultural skill; and hence their many ineffectual attempts to obtain such situations as afford a tolerable living. I would have them consider that a change has taken place in the minds of their employers; and that, in the person of a gardener of any note, it is now required to unite many important offices. To widen the boundaries of their knowledge is therefore indispensable; since, without a thorough understanding of rural affairs in general, they can scarcely

rise superior to common labourers. It is useless to expect the generality of gentlemen, in the present times, to engage gardeners to devote all their attention and time within the walls of their gardens; and as useless for the latter class of men to imagine that they will better their profession by persisting in refusing situations, which have annexed to them something more than the mere work of growing fruit and vegetables. It is beyond a question that gentlemen now meditate a retrenchment among their servants; and that, instead of keeping up individuals to preside over every separate department, various offices are now frequently merged in one person, who receives a competent salary. Now, since this is the case, it would be wisdom in gardeners to be doing all in their power to make themselves what they are required to be. They should employ all their time and talents in making themselves acquainted with country affairs generally, so as to be able to transact business with accuracy, to give a report on the state or value of plantations, &c.; and, in short, to write, talk, and act sensibly.

For the furtherance of this end, extensive reading, not only upon gardening, but upon all those subjects which are even indirectly connected with the profession, is highly commendable. I by no means wish to depreciate gardeners, yet I must say, that, considered as a body, they are, in knowledge, a step or two behind some of the working classes around them. They must, therefore, in their leisure hours, betake themselves to some important study, which measure can alone qualify them for rising to eminence in their profession. It may be observed, in general, that all those gardeners who hold the highest places, possess a degree of knowledge above those who have inferior situations; and that, according to the ratio of information each possesses, his order in society is fixed. If young gardeners would consider this important fact, instead of indulging in useless pastimes, much good would be the result. However, they have not as yet become so singularly lukewarm to the real interests of their calling, as to forbid us to expect much study and application from them, as soon as a proper method of instruction is pointed out. I have thought, that, in those districts where their number would permit, it would be an advisable plan to form themselves into societies, for the purpose of writing upon and discussing such topics as might be thought likely to interest them afterwards. If such a thing were instituted, its beneficial results could not fail to be manifold. It would improve its members in what is accounted the trifling, but with gardeners the material, art of penmanship, and it would also materially improve their dic-

tion; their ideas, which are too often hastily formed, would, by the ordeal which they would necessarily pass through, be refined; and, lastly, a taste for books and study would be instilled, which, in itself, is quite argument enough for the establishment of such an institution. If it were necessary, I could adduce actual proofs of the expediency and advantage of such societies. Though as yet rare among gardeners, many of them exist among mechanics; and, so far as I know, they have always been attended with success. A library forms a useful accompaniment to them; for the formation of which, a few shillings only would be required from each.

The diffusion of knowledge has of late become so general, that such a medium of improvement as I have stated must be resorted to by the younger branches of the gardening profession, to enable them at least to keep within sight of those who are rapidly approaching to perfection.

Feb., 1832.

J. G.

ART. III. *On the Necessity for increased Exertion on the part of young Gardeners to store their Minds with professional and general Knowledge.* By SCIENTIÆ ET JUSTITIÆ AMATOR.

Sir,

I HAVE frequently enjoyed much pleasure in reading your sentiments upon education, and the many advices and instructions you have imparted for the purpose of inciting young men to pursue the acquisition of knowledge, as necessary to their filling the station of head gardener with honour to themselves and satisfaction to their employers.

If ever there was a time when young men ought to bestir themselves, and pay particular attention to the cultivation of their intellect, it is surely now, when knowledge is majestically traversing the length and breadth of our land; not only visiting the splendid mansions of the great, but condescending also to enter the clay biggins of the humble poor; exerting its beneficial influence upon man in every grade of life; removing the veil which delusion had cast over truth; dispersing the mist and vapour which had obscured the mental landscape; and triumphing over ignorance, when seated most securely in her fortresses and strongholds.

The enjoyment which results from the acquisition of knowledge is so delightful, that this circumstance ought to operate as a sufficient inducement to the prosecution of it. The man who has a well-cultivated mind possesses a treasure

so purely his own, that all the devices of designing men will be insufficient to deprive him of it. It is a mighty resource, which will give an elevation and a sublimity to his conceptions; enable him to perceive the true nature of things; raise him above those deep-rooted prejudices which he had cherished as positive truth; and, fixed upon a foundation too secure to be ever swept away by the force of reasoning or the strength of argument, deliver him from many an unnecessary fear, and prove a great source of comfort and consolation to his mind, when forced to contend with the trials and adversities of life. Although it is clearly the duty and the interest of all to exert themselves, in order to keep pace with the march of intellect; it is peculiarly imperative upon the young man who aims at filling the situation of head gardener. As then he will be under the necessity of conversing or corresponding with his employer, it is requisite he should possess a scientific as well as a practical knowledge of his profession, and that his attainments in general information should be such as will enable him to act and conduct himself in a manner consistent with the sphere of life in which he must move.

Although it may be deemed the height of presumption in one, who is but young in years, and consequently has had only limited observation and experience, I cannot but say that, notwithstanding the many examples we possess of individuals who, in spite of the difficulties they had to contend with, on account of the wages of journeymen gardeners being so unaccountably and vexatiously low, have yet risen to respectability, if not to eminence, in the attainment of knowledge; there are still many who idly, uselessly, if not criminally, spend that portion of time which ought to be devoted to mental improvement. I have conversed with many upon this subject, and have frequently been told that the acquisition of knowledge was attended with no advantageous result; that interest was the only thing now-a-days; and that, since a person of considerable influence had promised to do something for them, they would not deprive themselves of enjoyment, and destroy their eyesight and constitutions with poring over books. I wish there were no truth in their statement, and that true merit would be sufficient to work its own way. I should not have adverted to this, if I were not fully convinced that it is by the attainment of knowledge only, that gardeners will maintain their place in society, and because I consider that to ignorance and indifference many of the evils of which we complain may be traced. I have frequently heard it made a subject of complaint, that in some

places the wages of gentlemen's gardeners have been considerably reduced; but, from what little has come under my observation, I am not in the least surprised at it. When a gentleman, whose premises are extensive, engages a gardener, he expects to find a man whose knowledge is commensurate with the station he is to fill; and when he finds, from experience, that his attainments scarcely exceed those of a common labourer, the question will very naturally arise, why should I give the one so much more remuneration than the other? When I see instances of men filling first-rate situations who are any thing but first-rate in their attainments, I feel more surprised that such should keep their places, than that the wages, in some instances, should have been reduced. Did the evil confine itself to the careless individuals themselves, it would not be so much; but it fills the mind with regret, to think, that, for the carelessness and ignorance of one, the comforts of another will be diminished, however learned and skilful he may be. The mischief does not end here: not only the intelligent head gardener suffers, but the poor journeyman must come in also for his share. There is scarcely an evil which he has to complain of (such as some of your correspondents have ably described, whether with respect to the distant, haughty, overbearing manner of the master; the insolence he must put up with; the insults, sneers, and direct despotism which he must bear without a word of discontent escaping from his lips, or the certainty of losing his place in consequence), but, in a great many instances, may be easily traced to the ignorance and presumption of the master. I would fain believe that there are few instances of well-informed men who use their young assistants in so disgraceful a manner. Knowledge, real knowledge, begets condescension, affability, and kindness. Ignorance, joined with prosperity, very often generates pride, vanity, and arrogance. It would be an easy matter to show proofs of the truth of these statements; but that is not the intention of this letter. To be placed under a vain ignorant master is a very disagreeable situation for a persevering young man; as he will often see men of decided abilities passed over, whilst individuals of very moderate attainments will be promoted.

I have no space to say any thing about the painful disappointment which a young man experiences, when, after devoting his time to the acquisition of knowledge, he perceives that, on account of the want of influence, he is likely to pass through life's dark vale unnoticed and unknown. To make knowledge more prevalent amongst gardeners, some method

must be taken, so as to make it apparent that it will be impossible to gain good situations without proportionate qualifications. I should be much gratified if either you, or some of your correspondents, would bestow a little attention upon this subject. If societies were formed where young gardeners could be examined, by unbiassed competent judges, previously to their obtaining situations, and certificates of character awarded to them as first, second, or third, according to the extent and depth of their abilities and knowledge, then ignorance would receive a mighty shock, every excuse for idleness would be thrown aside, and the principles of knowledge make rapid progress amongst us. If something of this nature were fairly commenced, there would be little doubt as to its success. Gentlemen would naturally apply for gardeners where they would run the least risk of being disappointed. There is scarcely a class of men that, in general, are in possession of so many means and opportunities for mental improvement as gardeners; and the necessity of such improvement being once made clearly apparent, and absolutely indispensable, the prosecution of it will not fail to follow. The advantages resulting from the formation of such a society would be very great. Then we should see few of those pretended gardeners, who are a disgrace to the name; then merit, unaided by patronage and favour, would work its own way; then carelessness and idleness would see that something else was necessary besides the influence of a Sir this, or a Lord that; and then every assemblage of gardeners, instead of exhibiting scenes of idleness or nonsense, would be converted into debating and literary meetings, classes of experimental philosophy, and mutual instruction societies.

I am, Sir, yours, &c.

SCIENTIÆ ET JUSTITIÆ AMATOR.

Near London, Feb. 7. 1832.

ART. IV. *On Gardening Recreations, as a Substitute for Fox-hunting, Horse-racing, and other brutalising Sports.* By Mr. THOMAS CLARK, JUN.

Sir,

It must be a source of great pleasure to every virtuous and reflecting mind, to observe how generally a taste for rational pleasures, as exemplified in the growing partiality for the study of natural history, and in the encouragement given to all the various branches of horticulture, is superseding the more hardy sports of the field, and the brutalising amuse-

ments in which our ancestors were prone to indulge. Even the highest and the noblest of the land now seem to vie with each other in their desire to obtain an intimate knowledge of the varied productions of the animal, mineral, and vegetable kingdoms; and more especially with regard to the latter, by bringing them to the utmost perfection which they are capable of attaining. As this noble emulation seems to be gaining ground every day, I trust the time is not far distant when fox-hunting, horse-racing (and its concomitant vices), with the more vulgar (but, in the Elizabethan age, equally fashionable) sports of bull-baiting, cock-fighting, &c., will be banished from the land. The "march of intellect," within the last thirty years, has, indeed, been most rapid; and, so long as it continues its present pace, an increased desire for becoming more intimately and practically acquainted with the works of nature will be its inevitable consequence.

The increased attention now given to the science of horticulture is, in no instance, more apparent than in the establishment of Botanical and Horticultural Societies in all parts of the kingdom, and in the liberal encouragement afforded to the constructors of horticultural buildings in general; and, in confirmation of the latter fact, it may not be improper to observe, that, being myself the proprietor of an extensive metallic hot-house manufactory in Birmingham, there have been constructed at my establishment, during the last fourteen years, no fewer than two hundred metallic conservatories, forcing-houses, fruiting-pits, &c. &c., of various dimensions, which, supposing them to be placed side by side, so as to form a continued line, would extend to the amazing length of 5000 ft., or nearly an English mile. Yet, notwithstanding the decided superiority of the metallic houses over those constructed of wood, the prejudice in favour of the latter is still so great, that, where one metallic house is erected, there are at least fifty of wood. It is gratifying, however, to know that this prejudice is fast declining, under the influence of the acknowledged fact, that, in all cases where a fair trial has been afforded to the metallic hot-houses (constructed upon their present much improved principle), so uniformly superior have they been found in all respects to those of wood, that whole ranges of the latter have been entirely swept away, and I have myself, within the last two years, been employed to replace some of them with metallic houses, to the extent (in two gardens alone) of 450 ft. I am, Sir, yours, &c.

THOMAS CLARK, Jun.

Metallic Hot-house Manufactory,
55. Lionel Street, Birmingham, Feb. 15. 1832.

ART. V. *On the Sap-vessels, or Circulating System, of Plants.* By the Author of "The Domestic Gardener's Manual," C.M.H.S.

Sir,

I HAVE, for a considerable period, felt assured that physiologists have not as yet attained satisfactory evidence of the precise nature and construction of the vessels, by which the sap is conveyed into, and distributed throughout, the vascular system of vegetable organised beings. Whoever shall have attentively perused the excellent compendium of vegetable physiology, commencing p. 160. of the *Encyclopædia of Gardening*, edition 1827, can scarcely fail to be convinced that the most eminent phytologists* have employed very discordant mechanism in their endeavours to establish, each one, his own favourite theory of what has been termed the ascent, or course, or circulation, of the sap.

I am induced, at the present time, to make this communication, in consequence of having met with a notice, in two newspapers, of a lecture recently delivered at the Medico-botanical Society, by Mr. Burnett of King's College; in which notice it was stated (I quote from memory) that that gentleman had produced a microscopic apparatus by which the motion of the sap was rendered as apparent, without the possibility of optical illusion, as the circulation of the blood in a frog's foot. Struck by the force and conclusiveness of the terms in which this notice was conveyed, and being desirous to ascertain the exact truth, also to what extent the lecturer had carried his observations, I addressed a letter to Mr. Burnett, and was almost immediately favoured with a polite and candid reply; before proceeding to state which, I am sorry to be constrained to observe that the public are but too often misled by these cursory notices in periodicals, which either announce too much, or so mutilate and distort simple facts as to produce much subsequent disappointment.

To those readers of your valuable Magazine, who are not aware of the precise nature of the discovery announced in the lecture referred to, it may be gratifying to be put in possession of the following facts. I solicit attention to the passages and words in italics, because they will be found to refer particularly to the remarks with which I conclude this paper.

In a lecture delivered in December, 1831, Mr. Burnett alluded to the experiments of Amici, Schultz, and others, by which the *motion of the sap* of certain plants had been made ocularly demonstrable: a fact which he had convinced himself was *no optical illusion*, by repeating and varying the

* From *phyton*, a plant, and *lego*, I read, discourse of, or *logos*, a discourse; i. e. one who discourses of, or describes, plants.

experiments. On the 17th of January last, he exhibited with a good microscope (in which too great a glare of light was avoided, by interposing Varley's dark chamber,) several specimens of *Chàra* previously dissected; and the motion of the sap was demonstrated to the satisfaction of the then chairman, Sir J. M'Gregor, and was seen by almost every one present.

It is admitted that the visible motion of the sap has, by recent observations, been verified only in three or four plants, *Chàra*, *Fìcus elástica*, *Alisma Plantàgo*, and perhaps *Chelidonium*: therefore, that the nature of the sap-vessels, in which it generally moves, cannot, as yet, be determined. The course of the sap in *Chàra* is so far ascertained, that Mr. Burnett thinks himself justified in declaring that each joint or limb has an individual circulation; and although it may have a communication with other joints, yet that its motion is complete in itself. A section of a rootlet, or of a joint, shows it to consist of two lateral, simple, semilunar ducts, each being the channel of a current that traverses the root or joint in an opposite direction to the other; the course of the one being up, the other down.

“These ducts, although *not spiral in their structure*, that is, *not spiral vessels*, are *spiral in their disposition*; being twisted as it were round a central axis, and forming two separate scalæ, much in the same way as the wild worm is often scored round the stems or branches of unfruitful trees.”

Having thus stated the exact and determinate extent of this important observation, so vaguely and yet imposingly announced in some of the public prints, it becomes a duty to solicit the attention of those of your readers who do not see the *Philosophical* or the *Horticultural Transactions*, to the luminous hypothesis of Mr. Knight. It has ever been the practice of that great man to keep no discovery concealed: he has published what he has discovered, and that in a manner which, as you, Sir, justly observe, in your *Encyclopædia of Gardening*, “renders all the papers of this eminent horticulturist so truly valuable,” namely, “by being accompanied with a rationale of the practice.”

Wishing to obtain all the information within my power, I corresponded with Mr. Knight on the subject of the sap-vessels; particularly, as I was confident, as stated at p. 324. of the *Domestic Gardener's Manual*, that the late Sir J. E. Smith had formed an erroneous opinion concerning Mr. Knight's view of the office of the spiral vessels; and I was favoured in the first instance with a reply, the substance of which I now add, in order to furnish a concise idea of the hypothesis that reiterated and conclusive experiments have finally led him to advocate.

Mr. Knight had long since proved that the specific gravity of the sap of trees increases in the spring, in proportion to its distance from the ground; and that saccharine matter is formed at that season in the alburnum (the young sap-wood) of trees which contained none in the winter. From these and other facts, Mr. Knight arrived at the conclusion, "that it is through the cellular substance of the alburnum, and not through its tubes, that the sap ascends."

The celebrated French philosopher, M. Dutochet, visited Mr. Knight at Downton, and spent nearly three weeks with him. Before they parted, the opinions of the two gentlemen became perfectly in unison. "We both agree," Mr. Knight says, "that the water and nutriment absorbed from the soil ascend through the cellular substance of the alburnum, and pass through vessels, cellular in structure, which surround the bundles of spiral tubes; that the nutriment absorbed becomes the true sap, or living blood, of the plant, by exposure to light, in the leaf; that it descends by the bark (wherever plants have bark), by which the matter that forms the layer of alburnum is deposited; and that whatever portion of the true sap is not expended, sinks into the alburnum through the mis-named medullary processes, and joins the ascending current. As autumn, however, approaches, the expenditure of sap diminishes, and it then accumulates in the alburnum, to be employed in forming the young shoots and leaves of the ensuing spring. I am in possession of a thousand facts to support this hypothesis, and not in possession of one fact in opposition to it."

From another very recent communication with which Mr. Knight has honoured me, in consequence of my urging the assured fact that fluids are at times discoverable in vessels of a tubular structure, I select the following passage, because it tends to throw light upon, as well as to confirm, the theory just adduced:—

"The tubes of the sap-wood (alburnum) are often, in the spring, quite full of sap; and trees then, such as the vine, the sycamore, and the birch, bleed. These may be called sap-vessels; but they are not the vessels through which the sap rises; because it will rise, and freely too, when all those are intercepted; and in the middle of summer, when the sap is rising most rapidly, in dry hot weather, those tubes are always dry and empty. They are reservoirs, which fill before the leaves are prepared to throw off the aqueous part of the sap which has ascended.

"It is most certainly through the cellular substance that the sap ascends.

“The medullary processes (as they have been misnamed) are formed convergently from the bark, not divergently, as I have demonstrated in the *Philosophical Transactions*. They are permeable to fluids; for when the bark is taken off in spring, a fluid is seen to exude from them, which, under favourable circumstances, will become perfect bark. The spiral tubes, when full grown, certainly contain no fluid; that is, nothing but air.”

When I wrote the three treatises on vegetable physiology in the *Domestic Gardener's Manual*, I was impressed by the weight of some of the authorities that I had been perusing; and, combining the facts stated with others derived from my own microscopic observations, I became partially convinced that in the tubular system of plants were to be found the real channels of, at least, the ascending sap. I had, indeed, detected fluids in the longitudinal tubes of some herbaceous plants, as, for instance, the tulip, wild hyacinth (*Scilla nutans*), and the like. In these, I clearly observed one or more bubbles of air interposed between portions of fluid, by which the latter was rendered more distinctly apparent. I had also noticed the partial ascent (or rather the diffusion) of coloured liquids through those portions of the longitudinal, semi-opaque masses, that physiologists had stated to be the ascending sap-vessels; but I was invariably disappointed in every attempt to introduce such colouring matter into the vessels of the leaves, by placing the lower extremities of young shoots in coloured infusions; although they remained therein for twenty-four, or thirty-six hours, and even, at times, exposed to the stimulus of a moderate heat. Facts and reiterated observations led me, therefore, to doubt the accuracy of many recorded experiments; and to question the philosophy of any inference, however plausible it might appear, which had been drawn from the investigation of mutilated parts of an organised being, that previously had been actuated by the vital principle. These doubts, and also a variety of queries that naturally suggested themselves, I stated in a paper which was read at a meeting of the London Horticultural Society, Jan. 18. 1831.

We ought not to deceive ourselves in our researches after truth. A detached dissected portion of a plant may exhibit apparent motion in the fluids it retains, it may also absorb the colouring matter of an infusion; but, surely, it would be as unreasonable to expect that an anatomist should demonstrate the natural circulation of the blood through the arteries and veins of a limb, deprived by amputation of the propulsive energy of the heart, as to believe that a detached and lacerated joint of a root or stalk could furnish undoubted evidence of

the real natural course of the vegetable fluids. It may be said that the analogy does not hold good throughout, because some cuttings of plants will grow, and become plants; therefore, that the circulating principle is not destroyed. I admit the objection, but maintain, that, although the vital principle may be retained, it is only in the buds, or parts allied to buds in their nature, each of which is, as it were, a separate system of life; and that the interrupted motion of the vital fluids is never really restored, till one or more of these vital germs develops itself in the protrusion of leaves and roots. This would form a most interesting subject for a future paper.

I would finally suggest, that if we ever expect to determine, beyond a question, the channels of the vegetable currents, we must operate upon living subjects; and to do this, a course of experiments, something like the following, might be undertaken:—Two or more young plants with very transparent stems, the balsam for instance, might be selected. Let one of these, growing in a small pot, be watered on all occasions with an infusion of Brazil-wood, logwood, or of the skins of black grapes or currants; and let another plant be taken up, and its roots kept in any similar coloured infusion. If upon inspection (by the microscope) of the stems uninjured, or even after cautiously removing the epidermis (cuticle), or a portion of the stem longitudinally, any of the colouring matter be found within the tubes or cells, and especially if it pervade any determinable part of the ramifications of the leaf-stalks, then, a conclusive result may be anticipated; and other experiments, repeatedly varied and accurately noted, may lead to a general theory founded upon facts.

But till some such experiments be carefully instituted and recorded (I purpose to make the foregoing experiments myself during the approaching spring), we must, I fear, be content to avow, with Mr. Burnett, that “with so few facts as we at present possess, it would be dangerous to generalise; and when we consider the very minute portions that can be submitted to examination, I do not think that the whole theory of the circulation is a point that will readily be settled.”

It is but just, however, to add, that Mr. Knight (judging from one or more of his direct statements to me) has microscopically investigated many living growing plants; and, with the most patient assiduity and minute accuracy, has dissected their integuments, and laid bare their internal structure: and I now avow, that from his statements, compared with my own observations, I see no sufficient reason to doubt that the real and regular conduits of the ascending sap are the cells (a part of them at least) of the alburnum; that the elaborated fluids

are carried to, deposited, and further prepared in, the cells of the bark; and there become the origin of the new layers, and of the "convergent" (formerly the divergent or medullary) processes. Finally, that other portions of the elaborated fluids are carried down through the cellular tissue of the bark, by the agency of the descending electric current, and form those rootlets which are always protruded at a period coincident with the developments of the buds and foliage.

I am, Sir, yours, &c.

Feb. 1832.

G. I. T.

IN the *Magazine of Natural History*, vol. iv. p. 542., a theory is exhibited which attempts to account for the ascent and circulation of sap in the following manner:—"The sap, in its ascent in the stem, becomes deprived of some of its constituents, more especially of its aqueous part: this deprivation is effected by the vital principle of the plant decomposing the aqueous parts, and assimilating the resulting gases to its own constituents. As the assimilation takes place, a partial vacuum is formed by the change of gases to a solid form; and this vacuum is immediately filled with sap rushing into it, according to the well-known law of the tendency of fluids to rush into any cavity deprived of the presence of air."

In a subsequent number of the *Magazine of Natural History* (No. xxiv., or vol. v. p. 197.) this theory is thus criticised by a correspondent:—"As the sap must have ascended once before this theory can come into operation, I want the author to explain what is the cause why the sap rises in the first instance into the upper part of the stem. What impulse forces or drives it up primarily, in order that, when it has ascended, the process of assimilation, &c., vacuum, and renewed supply, may take place in the manner the above theory supposes? When the author of the theory has given this explanation, I shall rest satisfied; but in doing this, he will, I apprehend, be under the necessity of subverting his own theory, as it occurs to me, that the cause which produces the first rise of sap will suffice to account for its subsequent ascent."

ART. VI. *Observations made on the Performance of a Hot-water Apparatus in a Pinery at the Earl of Egremont's, Petworth, Sussex, during the severe Weather in January last, by Mr. Harrison, the Gardener there. Communicated by Mr. COTTAM.*

THE pinery is 60 ft. long, and 12 ft. wide. It is 12 ft. high at the back, and 5 ft. in front; the boiler is 2 ft. in diameter; the quantity of water in the boiler and pipes is 160 gallons.

A small fire was made each day at three o'clock in the afternoon; a little more fuel was added at six and nine o'clock; and nothing more was done to the fire until the next day, at three o'clock in the afternoon. The quantity of coal consumed is less than one third of what was used when the common flues were employed. According to the present system, the whole of the water (160 gallons) is in circulation twenty-

five minutes after the fire is put under the boiler. There are nine houses at the Earl of Egremont's heated on exactly the same plan, all of which act remarkably well. Upwards of 20° more of heat could have been kept up during the severe weather in January last, had it been found necessary.

London, March, 1832.

G. C.

1831. Jan.	Time of Observations.	Temperature of External Air.	Temperature of Internal Air.	Water in the Boiler.	Wind.
14.	4 P.M.	29°	52°	96°	} N.
	10	28	70	212	
15.	7 A.M.	28	64	180	} N.W.
	3 P.M.	34	59	117	
16.	10	32	71	212	} N.
	7 A.M.	30	65	194	
17.	3 P.M.	32	58	150	} W.
	10	32	59	212	
18.	7 A.M.	32	64	168	} N.
	3 P.M.	34	60	159	
19.	10	32	77	212	} N.E.
	7 A.M.	27	70	190	
20.	3 P.M.	25	64	167	} S.E.
	10	21	76	212	
	7 A.M.	14	68	160	
	3 P.M.	23	60	154	
	10	31	78	212	
20.	7 A.M.	35	70	171	S.E.

ART. VII. *Various Recipes for destroying Insects, restoring the Bark of Trees, preparing Compost for Pines, &c.* By Mr. PETER MARTIN, Foreman in the Nursery of Messrs. Murray and Coss, near Leeds.

To destroy Ants and Woodlice, or Crickets, or Black Beetles. — Take one pound of oatmeal, and half a pound of coarse brown sugar, and mix them well together; add to it two ounces of pepper, ground as fine as possible. Lay the mixture upon white earthenware for woodlice and beetles, where they resort; and for ants cover it over, so as to prevent its getting wet.

Another Way to destroy Ants. — Toast the fleshy side of the outside skin of a piece of bacon, till it is crisp; then lay it on the ground at the root or stem of any fruit tree that is infested by ants. Put something over the bacon to keep it dry;

the ants will go under it, and fasten to it; lift it up quickly, and dip it into a pail of water.

An effectual Method of destroying Slugs, &c. — Take a quantity of cabbage leaves, and either put them into a warm oven, or hold them before the fire till they get quite soft; then rub them with unsalted butter, or any kind of fresh dripping, and lay them in the places infested with slugs. In a few hours the leaves will be found covered with snails and slugs, which may then, of course, be destroyed in any way the gardener may think fit. [We have tried this at Bayswater, and found it attended with complete success.]

Woodlice and Earwigs, wherever they exist, will also be attracted by leaves thus prepared, if placed in the sheds they frequent.

To destroy the Black and Green Fly. — Take some strong yellow clay, such as is used for grafting, put it into a tub, and fill the tub up with water; then make a man work it with his hands, till it becomes like thin paint. Fill a pan, such as flower-pots stand in, with it; and, as only the points of young shoots are infested with the fly, dip them into the clay and water: in ten minutes it will dry on the leaves, and will completely destroy the flies, or any other insects that may be upon them. The clay will look dirty upon the trees for a few days, but the first shower of rain washes it clean off, and the shoots will then look more healthy than before it was laid on. There is no fear of the return of the insects that season.

The Scale on Pines may be destroyed by the same mixture of clay and water. Mr. Wm. Murray, late gardener to the Earl of Maxborough, and Mr. Taylor, present gardener to the Marchioness of Hertford, lately tried the experiment on a pine or two covered with scale; and finding it answer completely, wished me to let you know.

To destroy the Bug [*American Blight, Aphis lanigera*] upon *Fruit Trees.* — Take clay, as I directed for the fly, and work it till it becomes of the consistence of whitewash; mix with every 6 gallons of it 2 lbs. of cream of tartar, 1 lb. of soft soap, and half a peck of quicklime. When you think the weather is likely to continue dry for some time, take a bucketful of this mixture, and with a large brush wash over the bark of the trees, wherever you think it is or has been infested with the bug. A man will do a number of trees over in a few days, with a whitewash brush and this liquid. Five years ago, I had some young apple trees that were completely covered over with the bug; I washed them with this liquid, and I have never since seen the least sign of the bug upon them. I have practised the same method repeatedly on other trees,

with the same success; and find it is only necessary to be careful to do it in dry weather, so that the rain may not wash off the mixture for some time.

To destroy Flies and Wasps. — A mixture of pepper, sugar, and water will do this effectually.

To make the Bark grow over Wounds and diseased Places in Forest or Fruit Trees, without fail, and with speed. — When a branch is cut off a tree, or otherwise wounded, make the place smooth with a sharp knife; and if the tree be cankered, either cut away the part affected, or scrape it out until you come to the sound wood. In all cases, make the surface as smooth as possible; then put half a pound of tallow into 2 lbs. of tar, and warm it over a fire, till the tallow is just melted in the tar; when 1 oz. of saltpetre should be added, and the whole stirred well together. The composition must then be laid on the parts that you want to heal: and I have found it, by long experience, to be an effectual cure, and superior by far to any thing yet practised.

To purify Soil or Earth to grow Pines or any other Plants in, so as no insect will infest either root or leaf, and in which all plants do much better than in any compost commonly used: I do not mean to say the pines only, but all plants without exception. — For pines, I take four barrowfuls of good rich earth out of a pasture field, one of leaf soil, one of sheep and one of cow dung fresh, and mix them all well. About a month before I want to use the compost, I lay it 1 ft. deep in a circle, and then lay some old pea rods, or old raspberry or gooseberry prunings upon it, and set fire to them; when they are burnt down I lay another foot deep of earth on the mixture, and then some more weed, and set that on fire, and so on, till I think I have as much as I want. I then turn it all over whilst it is hot, mixing it well together, and it is fit for use in one month. Pines will grow much stronger and larger, and be better flavoured, in this than in any other soil or compost that I am acquainted with, and neither bug nor scale will ever infest them. French beans will do well in this compost, or indeed plants of any sort. I was first induced to try this plan by seeing ground where there had been fires, in general grow vegetables of all sorts very strongly. I cannot tell what it is that is in the earth that the fire purifies; but I assure you that it is the best and easiest plan of keeping all insects off the pines. I have planted pines that had the bug and scale on them in abundance, and the plants were all quite clean in a very few days after I had potted them in my compost.

I should like very much for you, or some of your readers,

to try all the things I have mentioned as soon as possible, and to let me know what you think of them. There are twelve practical gardeners of us in this neighbourhood trying every experiment that we can think of; and if we find any thing worth notice, I shall take the earliest opportunity of letting you know. I remain, Sir, yours, &c.

PETER MARTIN.

Leeds, Feb. 28. 1832.

ART. VIII. *On certain Defects in Pleasure-Grounds, and the Mode of avoiding them.* By Mr. ROBERT ERRINGTON.

Sir,

It sometimes happens, in viewing the grounds connected with gentlemen's seats, that we do not derive that complete satisfaction which we think the thing capable of giving, and which, the expense and other things considered, they might be expected to afford. I believe that this happens, in no small degree, from the want of connection in the several parts of which such scenery is necessarily composed; every improvement, as it is called, which takes place, not possessing sufficient relation to the other parts, and of course causing those blemishes which generally attach to after-thought. However, much depends on the way in which the ornamental department is planted and conducted; and as a desire of improving the present style seems general, I venture to offer a few loose thoughts on the subject. Although I have nothing new to offer, and am not so much of the painter as some of your clever correspondents, still I hope something in my paper may be found useful, as I have practised considerably in these matters, for the last four years especially. However, I invite honest criticism, without which truth would scarcely get fair play.

I will suggest, in the first place, that intricacy and elegance of outline are not sufficiently attended to either in the formation of shrubby masses and of groups, or in the style of planting. How frequently we see fine specimens of timber and ornamental trees as studiously concealed by long tiresome tufts of shrubberies, as though they were considered deformities, and the shrubs in front as lumpish as though they had been clipped! The chief cause of that insipidity of form which shrubs too frequently present is owing, no doubt, to an improper disposition of them at first planting, and to the want of proper under-growths.

It appears to me that, in the first planting of trees and shrubs, nearly all the ornamental kinds, and those which possess peculiar character, should be kept just behind the foremost rank in an ever-varying outline, and that the front rank should be principally composed of evergreens, which should be allowed to spread, and become as irregular as possible on the grass. Immediately behind these would also be a good situation for the beautiful tree roses, instead of sticking them about singly on grass, where, as Mr. Spence justly observes, "they look just like a May-pole," and have a poor and desolate appearance. When their stems are supported by under-growths, they have, on the contrary, a gay and at all times a comfortable look; and, by towering here and there among the other ornamental trees, &c., do away with the squat aspect of the mere shrubs, and give a grace to the whole. To plant shrubberies which should possess charms all the year, I think that there should be two evergreens for one deciduous shrub; and all roses, azaleas, honeysuckles, and other scented or handsome deciduous

plants, should be placed in the small recesses formed between the evergreens; so that the general outline eventually should be formed chiefly or entirely by the evergreens.

As to the outline of shrubberies, in a majority of cases we find them composed of nothing but tiresome belts, running parallel to the walk; and if we meet with any thing like a mass or group detached, it must of course be an oval or a circle: indeed, these ovals, circles, and parallel lines are "the sins which most easily beset" a gardener. He is so much accustomed to them from his first entrance into horticultural life, that it is a miracle if he escape their trammels. Surely a continual play of outline, without adhering to any particular figure (except in the case of parterres and works avowedly artificial), is more in accordance with nature, and at the same time more graceful. The margin of grass also (whilst it must remain an edging), cut off by this style, adds to the elegance of the scene.

However, I protest against the continuance of formal edgings to shrubberies after the principal object is attained, of well covering the soil with elegance of form and beauty of tints; and I enter fully into the spirit of your observations to that effect, as expressed in your Magazine (Vol. VII. p. 543.). In planting the banks of water, if picturesque effect is desired, I am satisfied that the readiest way to obtain it, as far as trees and shrubs are concerned, is by thick planting; for pendulous forms are, beyond doubt, indispensable in this situation. I wonder much that such other accompaniments as Uvedale Price recommends are not more frequently attempted. Surely there are tasteful hands engaged in our profession, which could accomplish such matters. I own it would be rather daring: but whilst such materials as ponderous fragments of stone, and large roots or mossy trunks of trees are at hand, with a fine variety of rock plants and climbers, to effect a partial concealment; whilst the soil can be undulated, and trees be made to grow in almost any position, surely the difficulties should not be considered as insurmountable.

In the formation of walks, I have generally found that those which are a trifle below the level of the grass which bounds them always look most graceful to the eye; and then, by levelling the turf, and causing the margin, as it were, to die into the walk, those stiff, deep, formal edgings, of which you so justly complain, will be done away with. There should be no perfect levels longitudinally, if they can be avoided. The wet will of course hang sluggishly on such walks; whilst, by gradual undulations lengthwise, a very slight convexity of surface will be sufficient.

I remain, Sir, yours, &c.

Oulton Park Gardens, Nov. 8, 1831.

ROBERT ERRINGTON.

ART. IX. *Notices of large Trees in the United States and in Canada.*
Communicated by JAMES MEASE, Esq. M.D., Philadelphia.

THE great elm of Boston Common is 22 ft. in circumference. The Charter oak, in Hertford, Connecticut, 22 ft. An elm at Northampton, Massachusetts, is 21 ft.; another 22 ft.; and a third, 28 ft. in circumference. An elm at Springfield, Mass., is 22½ ft. and one 25½ ft. in circumference. A white pine [*Pinus Stròbus*] on the Kaatskill Mountains, New York, is 247 ft. long. (Dr. Dwight's *Travels*, vol. iv. p. 21.) On the Unadilla, Dr. Dwight mentions pine trees 3 ft. in diameter,

and 200 ft. high by estimation, p. 26. A button-wood (*Platanus occidentalis*), in Jefferson, Cayuga County, New York, on the Montezuma estate, is $47\frac{1}{2}$ ft. in circumference; the diameter of the hollow upwards of 15 ft., 2 ft. above the ground. (*Med. Rep. New York*, vol. iv. p. 427.)* A live oak at Dr. Rhode's, Beaufort, South Carolina, has a stem 32 ft. 5 in. in circumference; distance to a branch, 14 ft.: it is nearly of the same thickness the whole length of the tree.

An elm at Johnstown, near Providence, Rhode Island, at 2 ft. from the ground, is 24 ft. in circumference; at 4 ft., 21 ft.: it has eight main branches. In Aurelius, New York, there is another elm 33 ft. in circumference. At Raleigh, North Carolina, there is an oak which, sixty years ago, was so small, that the owner bent it down, and cut off the top: in 1817, at the ground, it measured 25 ft. in girth, but as high as trees are usually cut, 15 ft. At noon, the tree covers with its shade a circumference of 333 ft.

A weeping elm (*U. americana*), before the door of Thaddeus Burr, Fairfield, Connecticut, a few years since, was 24 ft. round, at 1 ft. from the ground. A man, alive in 1807 (then 97 years old), planted it.

On the plantation of Mr. Adams, on the river Schuylkill, is a button-wood tree, 27 ft. in circumference.

Michaux mentions that "36 miles from Marcetta, in Ohio, on the right-hand bank of the river, he measured a button-wood, at 4 ft. from the surface, and found it 47 ft. in circumference. It appeared to preserve the same dimensions to the height of 15 or 20 ft.; and it then divided into many limbs of proportional size." His host offered to show him others, equally large, two or three miles off. He quotes his father's journal, for another button-wood, which he saw in an island in the Ohio, fifteen miles above the mouth of the Mushingum, which, at 5 ft. from the ground, when the bark was smooth, measured 40 ft. 4 in. in girth. (*Journal*, p. 92. Paris, 18.) In his *Memoir on the Naturalisation in France of the American Fruit Trees*, Paris, 1805, he gives a large table of the heights of various trees in North America.

In the first volume of the *Memoirs of the Philadelphia Society for promoting Agriculture* is a paper, by the late John Pearson, Esq., Senator of the Pennsylvania Legislature, on the dimensions of numerous American trees, principally taken by himself. This work is in the library of the British Board of Agriculture, and of the London Horticultural Society.

Philadelphia, Sept. 20. 1829.

J. M.

* Certified by eleven citizens.

A paper published in Gore, Upper Canada, mentions a pine tree now [1829] growing in that vicinity, which, about a yard from the ground, measures $20\frac{1}{2}$ ft. in circumference, and appears to be but little less at the height of 60 or 70 ft. Its whole height is estimated at 200 ft. It is known by the name of the "Johnny Martin Pine," from the circumstance of a Scotchman of that name, who once lived near it, always stopping for a considerable time as he passed that way, and viewing it with mute astonishment.

ART. X. *Description of a Tree-Guard in Use at Thainston, in Aberdeenshire.* By W. TAYLOR, Gardener, &c., to D. Forbes Mitchell, Esq., of Thainston.

Sir,

THIS tree-guard (*fig. 36.*) is made of Scotch pine, spruce, or larch spires, sawn down the centre. The four upright

36

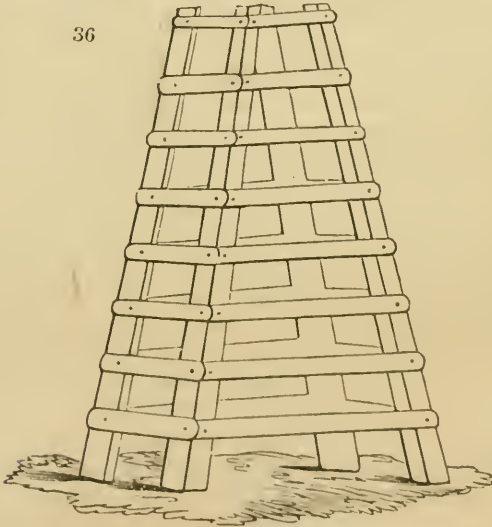

posts are charred at the lower end, and sunk in the ground 15 in. or 18 in. Scotch pine lasts seven or eight years; larch or spruce, ten years. The expense of each is from 2s. 6d. to 3s. This tree-guard also answers for a stay to a newly transplanted tree, which should be wound with straw rope opposite the top of the guard, where the tree can be fixed by two cross bars and soft rope.

I am, Sir, yours, &c.

Thainston, Sept. 15. 1830.

WM. TAYLOR.

ART. XI. *Design for a Flower-Garden, intended for a particular Situation near an old Mansion, with a List of Plants for Summer Display.* The Plan by C. D., and the List by Mr. GEORGE WOOD, Gardener to Thomas Hope, Esq. M.P., of Depedene, Surrey.

OUR readers, on turning to Vol. VII. p. 298., will find a plan of a flower-garden in the ancient style, adapted to a very peculiar situation, by C. D., with a list of plants by Mr. Baillie of Dropmore. The plan now presented (*fig. 37.*) is by the same artist, and for the same situation, but in a different style. The mode of planting is also different; being calculated to make a summer and autumnal display only, and not a display during the whole year, like Mr. Baillie's list. Mr. Wood having had great experience and success in this kind of floriculture, as the splendid groups in the sequestered valleys of Depedene testify every summer, we consider this list likely to prove generally useful to gardeners who have lawns to decorate. As it was made upwards of three years ago, it does not, of course, contain the newest things.

List of Shrubs and Plants to be trained against the Wall (fig. 37. d).

Bignònia grandiflòra	Magnòlia grandiflòra
radicans màjor	obovàta
capreolàta	purpùrea
capénsis	conspícua
Clématis flámmula	Wistària Consequàna
flórida	frutésces
flórida double	Robínia hispida
Passiflòra racemòsa cærùlea	ròsea
Rùbus rosæfòlius	Sutherlándia frutésces
Ròsa Bánksia álba	Bérberis Aquifòlium
lútea	Calycánthus flóridus
yellow China	Púnica Granàtum
Boursaúlti	Cydònia japónica
Bengal flórida	japónica álba
microphýlla	Ribes sanguíneum
sanguínea	Lupinus arbóreus
Barclayàna	Bouvardia triphýlla
Watts's seedling	Aristolòchia siph
Champneyàna	Celástrus scándens
animating	Dáphne collina
Drummond's seedling	hybrida
índica màjor	Salisburya adiantifòlia
Acàcia Julibríssin	Kérria japónica
Chimonánthus frágrans	Aúcuba japónica
Piptánthus nepalénsis	Chrysanthemums, different sorts
	Alstrømèria hirtélla.

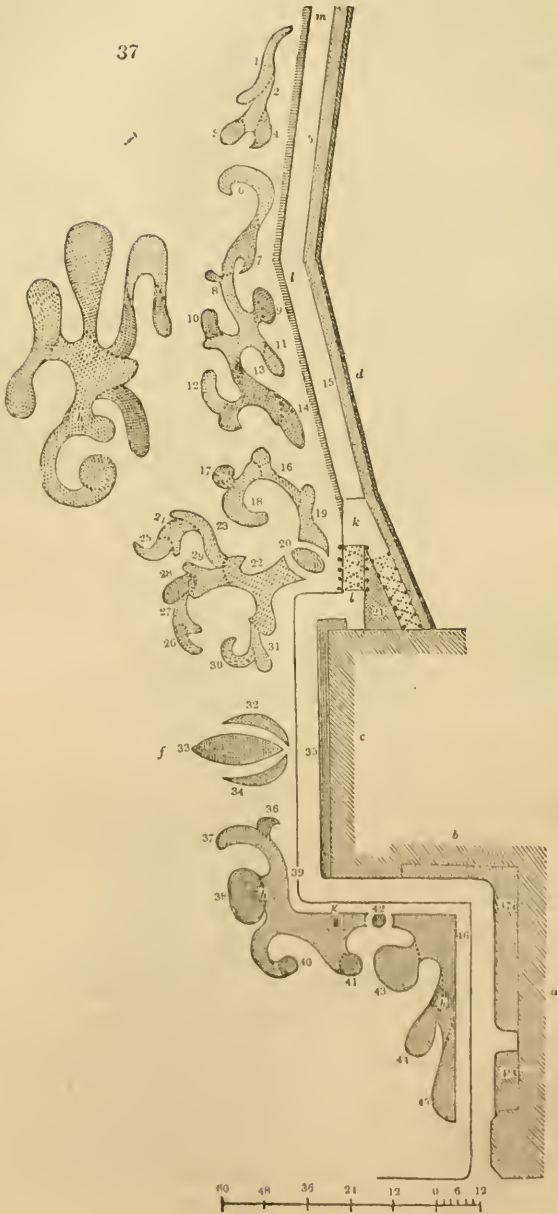

Explanation of the letters on the plan. (*fig.* 37.)

a, Library. *b*, Music-room. *c*, Conservatory.

d, Kitchen-garden, enclosed by a wall with battlements.

e, Group of one kind of plant, no matter what, separated from the groups in the same compartment by lines of garden pinks; which plant is preferred in order that the division-lines may be green all the winter.

f, Lawn. *g*, Stokehole, with a pedestal and vase over.

h, A collection of *Ròsa semperflòrens*, *Noisetteana*, &c.

i, Arcades of trellis-work for creepers.

k, Sloping ascent to terrace-walk. *l*, Terrace-walk.

- | | |
|--|--|
| 1. <i>Verbena Aubletia</i> | 26. <i>Clarkia pulchella</i> |
| 2. <i>pulchella</i> | 27. <i>Petunia nyctaginiflora</i> |
| 3. <i>Lamberti</i> | 28. <i>Anchusa paniculata</i> or <i>italica</i> |
| 4. <i>chamædrifolia</i> | 29. <i>Calliopsis bicolor</i> (<i>Coreopsis tinctoria</i>) |
| 5. Herbaceous plants | 30. <i>Anagallis Webbiæna</i> |
| 6. <i>Calceolaria rugosa</i> | 31. <i>fruticosa</i> |
| 7. Lavender | 32. <i>Heliotropium peruvianum</i> |
| 8. <i>Rhus Còtinus</i> , pegged down | 33. Scarlet pelargoniums |
| 9. Stock, red ten-weeks' | 34. <i>Heliotropium corymbosum</i> |
| 10. <i>Fuchsia gracilis</i> | 35. Herbaceous plants |
| 11. Stock, white ten-weeks' | 36. <i>Lýchnis fulgens</i> |
| 12. <i>Delphinium grandiflorum</i> | 37. <i>Mignonette</i> , <i>Reseda odorata</i> |
| 13. <i>Sálvia splendens</i> , pegged down | 38. <i>Georginas</i> , dwarf varieties |
| 14. <i>Fuchsia microphylla</i> | 39. <i>Agératum mexicanum</i> |
| 15. Herbaceous plants | 40. <i>Lobelia fulgens</i> |
| 16. <i>Lupinus polyphyllus</i> | 41. <i>syphilitica</i> |
| 17. <i>polyphyllus albus</i> | 42. <i>Lupinus mutabilis</i> |
| 18. <i>Lobelia cardinalis</i> | 43. Variegated pelargoniums |
| 19. Collection of varieties of hearts-
ease | 44. <i>Sálvia fulgens</i> , pegged down |
| 20. <i>Asclèpias tuberosa</i> | 45. <i>Eschscholtzia californica</i> |
| 21. Herbaceous plants | 46. <i>Pæonia</i> , all the species and va-
rieties of |
| 22. Carnations | 47. Herbaceous plants |
| 23. French marigold | 48. Herbaceous plants. |
| 24. Red Chinese aster | |
| 25. African marigold | |

ART. XII. *On the Culture of Nelumbiums.* By C.

THE *Nelumbium speciosum* should be planted about the beginning of May in England. The seeds should have a small hole filed in the shell at the end opposite to the point, and should be then put into a basin of water, and kept warm for a few days, either by putting them in the sun, or near a stove. In about ten days the seed will have made its first leaf, which comes out some days before the root fibre; it may then be planted in a tub of mud, and placed in a green-house, from which the plants have been removed. The tub should be about 3 ft. wide by half that depth, filled with mud to within about

5 in. of the top of the tub, the remaining space to be occupied with water. The part of the tub covered with water should be painted, to prevent the growth of *confervæ*, which are very destructive to the young plants. As *confervæ* grow rapidly in still water in any warm place, the top of the mud should be covered with fine sand for about an inch; and when the water is changed, which it should be twice a week, this sand should be slightly moved about, and the inside of the tub, as far as the water goes, rubbed; fresh water should be poured in from a pot with a rose. This should be done early in the morning. As the young leaves appear they should be bent down with a stone to the surface of the sand, till the stalk has extended itself long enough for the leaves to remain on the water; for if this were not done, as the plants grow naturally in water several feet deep, the young leaves would soon rise through the few inches of water at the top of the tub, and would get withered by the sun. The *nelumbium* has two sorts of leaves; one weak, which rests always on the surface of the water, and the other much stronger, which rises above it. The weak leaves are those first produced; after about a month, when the tub is covered with these, the stronger leaves appear, and rise out of the water 2 or 3 ft. high. (*fig. 38.*)

38



The plants then require much less care, as the green slime (*confervæ*) does not grow readily when the water is shaded by the leaves. They should be kept as nearly as possible in a temperature of from 75° to 80° of Fahrenheit; that is, by day; but at night the house should, when the weather is not very cold, be left quite open, also sometimes in the day, during rains. It would be as well to white-wash the inside of the glass, as any knots in it would burn the tender leaves. Towards the middle of September they should be inured gradually to the open air; and by the end of the month the tubs may be

placed in the open air, and left there without any covering till the following spring. The frost has no effect on the roots. The following spring they should be put into another tub newly painted inside as before, with one half fresh earth. The

nelumbium grows and flowers abundantly when planted in tubs in Italy, care being taken with the young plants as above. From the want of some such care in England, the young plants are generally lost, and the plant is seldom seen in collections, though probably any one possessing a greenhouse might rear it to perfection. The rose-coloured nelumbium and the yellow nelumbium flower and seed abundantly in Italy, and are both fragrant and beautiful. It is to be regretted, that, as there are many varieties of nelumbium in China, more of the seeds are not sent to Europe. The double white and double crimson varieties appear of surpassing beauty, from the drawings made of them in China. The seeds will keep fresh any length of time.

Milan, 1831.

C.

ART. XIII. *On the Cultivation of Brugmánsia arbòrea [suavèolens] in a Conservatory.* By Mr. JAMES ARNOLD, Gardener at Grove House, Cheshunt.

Sir,

MR. GIBSON having treated of the cultivation of small plants in pots (Vol. II. p. 145.), I now send you my manner of managing large ones planted out in the conservatory. In June, 1829, I had a plant of brugmansia given me, struck from an eye, as Mr. Gibson recommends. I took it home, and planted it in the conservatory, and the same summer it had on it 54 flowers at one time. Early in the spring of 1830 I cut it down before the sap was in motion, about 6 in. from the ground; and in June following it had on it 4 flowers, in August 74 flowers, and by the latter end of September 200 flowers; though I had the misfortune to get a branch broken off through the weight of flower buds on it. In the spring of 1831, I cut it down as before, but about 2 in. higher; in June the plant had on it 7 flowers, in August 86 flowers, and in October 355 flowers. This plant was greatly admired by all who saw it.

I attribute its flowering so profusely to cutting it down, and keeping it well supplied with liquid manure; for if this plant get once dry, so as to flag, it very much retards its growth, and injures its flowering. As the conservatory at this place is attached to the house, the family used to set the door open to admit the fragrance of the flowers into their apartments. I have been told that the brugmansia cannot be kept clean; but I have always kept it clean by sprinkling it about twice in the summer with tobacco water: keep the plant

in a flourishing state, and it will take but little trouble to keep it clean. It delights in a rich soil, with plenty of room for its roots, and as no plant bears the knife better, it can always be kept within bounds. No plant strikes more freely from eyes, cut like those of the vine. I do not state this for professional men, but for those who, like myself, have to gather our knowledge by bits and scraps from your Magazine, and such publications as come in our way. The *Cineraria* is an almost neglected genus of plants, though they make such a gay appearance in the early months of spring, with other spring-flowering plants. I am, Sir, yours, &c.

Grove House, Cheshunt,

JAMES ARNOLD.

Feb. 19. 1832.

ART. XIV. *On the Propagation and Culture of Polýgala cordifolia, Eutáxia myrtifolia, and Phænócoma prolifera.* By Mr. J. NICOLLES, Gardener to R. Pettward, Esq., Finborough Hall, Suffolk.

Sir,

THE following remarks relative to the propagation of the above-named plants may be of service to amateurs. Practical gardeners may also find them useful with regard to other plants, which, like these, are subject to damp off in a frame with dung heat; and which, therefore, will alone succeed under the following treatment. The method I adopt is, as soon as the parent plants make shoots about three quarters of an inch in length, say about the middle of February, I take off cuttings, and insert them in white sand, placing them under a bell glass, in a house kept usually at 60° or 65° of heat; taking care to put the cuttings in as soon as they are made, and watering them as they become dry: in course of six weeks they will be fit to pot off, and will, by the end of summer, make good plants, which will probably begin to flower in autumn.

Eugènia anstrális deserves a place in every collection of green-house plants. I planted one in the bed of a conservatory three years ago, which grew, in two years, to the height of 14 ft., when I was obliged to stop it, as it reached the roof. It has ever since been loaded with fruit, which, varying in colour from a deep crimson to a pure white, and contrasting with its deep green foliage, renders it a beautiful object during winter, particularly by candlelight. The plant grows faster than the common myrtle in loam and peat mixed, or in either of these soils and leaf mould. I am, Sir, yours, &c.

Finborough Hall, Dec. 22. 1831.

J. NICOLLES.

ART. XV. *A Method of cultivating Pelargoniums, as practised at Horsforth Hall Gardens.* By MR. THOMAS APPELBY.

Sir,

IN describing new methods of cultivating fruits, vegetables, or flowers, it may very probably happen that different persons may at the same time have made the same discoveries, and be using the very same means with equal success; yet, as it must be allowed that a great many cultivators follow the same beaten track of gardening that their forefathers have done, without once thinking it possible to improve it, I think it advisable for every gardener to communicate the results of his own experience. It is for this reason that I offer you the following remarks on growing pelargoniums; for though there may, no doubt, be many (especially in the nurseries near London) who practise the same method as myself, I can only say that, as they have not described that method in the *Gardener's Magazine*, I hope they will not be offended if I attempt to do so, and by that means make it more generally known.

The sorts I subject to this peculiar treatment are those splendid garden varieties of *Pelargonium*, *quinquélobum*, *zonale*, and *cucullatum*, so generally known, and commonly called geraniums. About the 1st of July, I take cuttings with three joints, from the sorts I wish to increase; and with a sharp knife I pare off the bottom leaves quite close to the stem, and finish preparing the cutting by a clean cut across the bottom joint. The pots to receive them are then made ready: they should be about 9 in. in diameter, and be filled within an inch of the rim with a compost of rotten leaves, loam, and peat, in equal parts; and the remaining inch with pure virgin loam, which, if it be not naturally light, may be made so by the addition of some clean pit sand. The cuttings are then put in, close to the pot side, with a small dibber, and are pressed pretty tight, giving a good watering, and placing them in a frame facing the south. The size of the frame, of course, should be in proportion to the number of pots. In sunny weather my plants are shaded from nine o'clock till three, or as circumstances require. When they have been in about ten days, a little air is given to them, by propping up the lights behind; any dead or mouldy leaves are carefully picked off, and, if they require it, a little water is given, without wetting the leaves. As soon as the cuttings are rooted, they are potted into large 60-pots, in pure light loam, and replaced in the frame, which is kept close for a few days, and shaded until they have struck fresh roots, gradually inuring them to the open air. The lights are then drawn off

every mild day, until it is necessary, on account of frost, to place them in the green-house; after which, regular attention is given as to watering, picking off decaying leaves, smoking with tobacco when needful to destroy aphides, and admitting as much air as possible every mild day.

The plants are now of short stunted growth, and in March some early sorts will show flower-buds. Towards the latter end of the month some rich compost is prepared as follows; viz. take equal parts of vegetable mould, good loam, and well rotted cow dung, at least a year old, and mix the whole well together, but do not sift it, and put it under cover a few days to dry. The plants are then brought into the potting shed, and are shifted into pots 6 in. in diameter. While they are out, the green-house is well cleaned, white-washed, &c. The plants are then arranged as widely as possible; a little extra-heat is given, with abundance of water, and air, as the season advances.

The progress they now make is quite surprising; and fine, stiff, bushy plants, covered in profusion with large bunches of finely coloured flowers, richly reward the cultivator with all their beauties, for his care and attention.

When the bloom, or most of it, is over, they are turned out of their pots, and planted in the flower-garden or shrubbery, in clumps or irregular masses, where they ornament the scene, during the summer and autumnal months, until the frost kills them.

The essentials in this mode of treatment are, — striking cuttings in July every year, which prevents the plants getting too large; potting, when struck, in small pots and poor soil; shifting in spring into large pots and very rich compost; and planting out or throwing away in summer.

I am, Sir, yours, &c.

Horsforth Hall, Nov. 1. 1831.

THOS. APPLEBY.

ART. XVI. *On the Culture of Pelargoniums.* By ROBERT ELLIOT, Gardener to William Hartley, Esq., Rose Hill, near Whitehaven.

Sir,

THE pelargonium is one of the greatest ornaments of the flower-garden; and when the length of time it continues in flower is considered, the endless variety now cultivated, and the many new and beautiful kinds annually raised from seed; it becomes a subject well worth enquiry, how this plant may

be raised in the best and cheapest manner possible. During a period of many years, it never occurred to me that pelargoniums could be preserved during the winter months, in this northern climate, without the assistance of artificial heat; but having now discovered a means of conquering this difficulty, I take the liberty to lay before you a statement of the method I have practised for the last three years with complete success.

It is necessary, in the first place, to be provided with a light garden frame, which may vary in size, according to circumstances, or the number of plants required. The one I use for this purpose at present is $4\frac{1}{2}$ ft. by $2\frac{1}{2}$, 20 in. deep in the back, and 18 in. in front; which will contain seventy or eighty plants in small pots. — The most common method of raising the plants is by cuttings. In May, June, or July, I take the cuttings off at the third joint, and pot them in small pots one in each, in rich loam, mixed with about one third of vegetable mould; I then place the frame on a south border, in a free open situation, on the common soil, and put the pots in it, shading them with a mat for a few days, and giving little or no air for a week. I afterwards increase the quantity of water gradually, giving a little more every time till they are able to stand the sun without flagging in the leaf. I continue watering them gently until they are well rooted, and then remove them into the open air, to stand, during summer, on a good gravel walk, or an open space covered with coal ashes, to prevent worms from getting into the pots. When the plants begin to grow freely, I pinch off the top shoots, by which means they send out side shoots; otherwise each plant will invariably send up only one, which looks naked and unsightly; whereas, a plant low and full of foliage has a handsome appearance, and flowers freely. — Some of the more tender and delicate kinds of pelargonium may be propagated by cuttings of the roots an inch long. Plant these round the side of the pot an inch apart, leaving the eighth of an inch of soil above them. Set them in the frame, and when they have pushed a little, plant them in separate pots, giving air and water regularly; when they have grown a few inches, remove them into the open air, and treat them in the same manner as plants raised from cuttings. — Seeds may be ripened well in the open air, from plants kept in pots; but those transplanted into the borders (growing very vigorously) seldom produce good seed. Sow the seed in March, in soil similar to that recommended for the cuttings, adding a little sand to it; place the pots in the frame a few inches from the glass, and, when about 2 in. high, plant them in separate pots; let them remain in the frame till well rooted, and

then remove them into the open air to remain during summer. Plants thus raised will flower well the second year, and many new and beautiful varieties may be obtained.

Plants kept long in pots grow naked and stunted, and require to be headed down to within a few inches of the pot; when this is done, set them in the shade, and give no water for a week before and one after the operation; this prevents the plants from bleeding, which often destroys them altogether. About the latter end of October, or on the first appearance of frost, the plants raised from seed, from cuttings, or from roots, and kept in small pots during summer, should be placed in the frame, with a few inches of coal ashes below the pots to prevent the plants from suffering from damp during winter. Shut up the frames closely at night, and give air freely during the day. As the winter advances, give water sparingly; and pick off all decayed leaves as they appear. Cover all round the frame with about a foot of soil pressed close, and nearly level with the glass; sloping a little, to carry off the wet. When the frost sets in, cover with mats at night; and when the weather is very severe, use a straw mat, and over all a wooden shutter, a little larger than the frame. Give air every day when mild, and in severe weather uncover the frame when the sun's rays fall upon it, taking care to cover when the sun leaves it in the evening. As the spring advances, give air more freely, by sliding down the sash altogether in the daytime, to prepare the plants for being turned out of the pots, and transplanted into the flower-garden; which may be done about the beginning of May, if the weather is seasonable. Let them be planted about 2 ft. apart. They will come into flower by the latter end of May, and continue to flower with great beauty and splendour until the latter end of October.

In 1830, at Rose Hill, the pelargoniums continued to flower until the middle of November. By this method a constant supply may be kept up, at a very moderate expense. When large plants are wanted, such as have been transplanted during summer may be taken up carefully about the beginning of October, and planted in large pots. They should then be set in the shade for a week or two, and given water plentifully. Plants treated in this way frequently flower all the winter, but generally come into flower by the beginning of March.

ROBERT ELLIOTT.

Rose Hill, near Whitehaven,

March 31. 1831.

ART. XVII. *A Descriptive List of such Apples as have been found to succeed in the Neighbourhood of Kilkenny* in Ireland.* By Mr. JOHN ROBERTSON, F.H.S., Nurseryman there.

Sir,

YOUR call on your friends in the different quarters of the United Kingdom, to supply you with lists of the fruits most in esteem there, was well conceived, and, if attended to, would render a valuable service to that branch of horticulture, by pointing out to others placed under similar circumstances the sorts most likely to succeed in their own situations†; and

* Fynes Moryson, secretary to Lord Deputy Mountjoy, in his *Itinerary* written 1598, says of Kilkenny:—

“It is a pleasant town, the chief of the towns inland; memorable for the civility of the inhabitants, the husbandman’s labour, and the pleasant orchards.” Some of these orchards were planted by the monks previously to the year 1500, in the abbey gardens. These have all perished, or have been destroyed; the last tree was blown down in a storm a few years hence, and had only the bark of the stem remaining to support its head, and yet bore abundantly; it was the smaller Summer Bon Chrétien. Others which were planted on the banks of the Nore, and are nearly of the same standing, still remain in all the vigour of a healthy old age. One of them, about three quarters of an acre, is leased at 50 guineas a year rent; a tree in it, of the Sadler’s Jack Pear, bears one year with another 20,000 fruit. These orchards mostly consist of pears: Chisel, Cuisse Madame, Bon Chrétien, the Old Catherine, and Autumn or Kilkenny Bergamot, which in this place is famous for its superior flavour.

Kilkenny lies in north latitude $52^{\circ} 35'$, west longitude $7^{\circ} 25'$; about 40 miles from the sea coast, and 500 ft. above its level. The soil in its neighbourhood is calcareous, for the most part gravelly, and seated on a gravelly subsoil, or one of gravelly loam, under which in most directions limestone rock may be met with. It possesses, also, strips of rich alluvial soil on the banks of the Nore, on which some of its best orchards are to be found, though planted two or three hundred years back.

These soils are upon the whole eminently favourable to the flavour of fruit; but the climate, like that of the rest of Ireland, is adverse. High winds and heavy rains are frequent, and its cloudy skies and moist hazy atmosphere permit the direct radiant rays of the sun to penetrate them but feebly. From the observations which I made in the year 1828 (and the heat of that year may be taken as an average), I found that the mean of maximum heat, taken at 1 P. M. in the shade, during the months of April, May, June, July, August, and September, which are the most influential on the ripening of fruit, was 62° Fahr.; while that of the radiant sun heat taken at the same period in an open situation was but 67° ; an excess of no more than about $\frac{1}{12}$. The mean heat of the earth, 2 ft. deep, was 57° ; and though only about one degree more to the north than London, our fruits ripen a fortnight later, a month later than those of Paris, and about a week earlier than those of Edinburgh. The grape, which ripens on the open walls much farther north in England, though it sometimes colours, yet, to my recollection, never ripened in the same situation but in the years 1825 and 1826. Of the apple (though not numerous) we have some fine old Irish varieties, not excelled by any of modern introduction.

† Fruits transferred from their favourite situations to a warmer climate usually degenerate towards the extreme of meanness; to a colder

experience has proved that every variety of fruit has a peculiar locality of soil and climate, in which it arrives at its highest perfection, and that if removed to another (even though superior in fertility, if it be less suitable) it often degenerates and becomes worthless, and its former high character proves but a source of disappointment. This I have found to be the case in numerous instances of fruits which were in the highest repute in France and England, and I have spared neither trouble nor expense to procure such from every quarter as might prove an acquisition to this country. Disappointments of this nature, such local returns as you require would go far to remedy, if accompanied by accurate notices of the circumstances under which the fruits are placed; and I here endeavour to redeem my pledge given to that effect, by sending you a list of such sorts of apples as I have found by experience to answer best in this neighbourhood, uniting the essential requisites of good quality and abundant produce, and purpose a continuation of the other kinds of fruit, until the series shall be complete.

As a dry enumeration of names, in the present confused state of fruit nomenclature, would be of little avail, I shall add to them such descriptions as may serve to identify the variety, by selecting its most striking characters; and, to avoid occupying your space unnecessarily, shall omit such others as are of minor importance. In order to facilitate that object, I have also divided these apples under three distinct heads; and each variety will follow in succession, according to its order of ripening, so as to form an assortment of the choicest kinds for each season, sufficient for every useful purpose*; but as a greater number may be desirable, I have added a supplementary list of such as I conceive next in quality; and should farther experience enable me to enlarge it to advantage, I shall be anxious to communicate the result.

It would be highly desirable that an effort should be made to renovate the very useful dwarf stock called the Dutch Paradise, or what the French call the Doucin, as it appears to be fast degenerating to old age and canker. This individual variety existed before Miller; it may be renewed from seed, and, I am persuaded, with all its former, and perhaps with new, good qualities. Apple trees raised from the seed often present a striking resemblance to the parent stock, both in their habits of growth and in their fruit.

climate, towards that of acidity or insipidity; and, *vice versa*, when removed to such as are more fitting, they improve.

* Should a still narrower selection of the best bearing apples be required for a very small garden, they are marked with a star.

EARLY APPLES. †

1. * *Scarlet Eve* (Early Margaret of the *London Hort. Soc. Catalogue*).—A middle-sized oval fruit, flattish at the eye and stalk. Eye shallow and wrinkled. Stalk short, inserted in a shallow cavity. Sides slightly angular. Ground colour when ripe, a yellowish green in the shade, to the sun a bright crimson marked with darker streaks and some russet about the stalk. Flesh whitish, sometimes tinted with red next the skin; crisp and juicy; flavour saccharine, pleasantly acidulated, and accompanied by a perfumed odour. Ripe the earlier part of August. The tree is middle-sized, grows erect, and bears well. One of the earliest, and the best apple of the season: we reckoned it an Irish fruit, but it has been so long and universally known, that its origin is doubtful.

2. * *Oslin Apple*.—A middle-sized roundish oblate fruit. Eye wide and shallow, its calyx often prominent, and a little wrinkled. Stalk short, inserted in a wide and shallow cavity. Sides sometimes slightly angular. Surface when ripe a bright yellow speckled with russet, which is also clouded about the stalk. Flesh yellowish, crisp, and juicy; flavour delicate, sugary, and aromatic. Ripe the end of August. An excellent fruit, of Scotch origin. The tree is dwarfish in its growth, makes erect shoots of a light grey colour, has leaves of a light green, and is an abundant bearer.

3. *Red Astrachan*.—Above the middle size. Roundish, a little flattened at the ends. Sides irregular. Eye broad and deep, but closed by the calyx, and uneven on the edge. Stalk short, and deeply sunk in an angular cavity. Surface of a deep cherry red to the sun, covered with a purplish bloom, and yellowish mixed with a lighter red to the shade. Flesh very white, tinted with red next the skin, firm, juicy, and well flavoured. A beautiful fruit, originally from Russia, and ripe the end of August. The tree grows strong and erect, and is a good bearer.

4. *Peach Apple*.—An Irish fruit, somewhat above the middle size; its transverse diameter greatest. Sides irregular,

† The selection given is classed under three heads: early fruit, which ripen on the tree from July to the end of October; middle season fruit, which are in use from October to the end of January; and late keeping fruit, from January to the return of the season. I term those fruits small which do not exceed 2 in. in diameter; middle-sized, between 2 and 3; and large, such as are 3 in. and upwards. The terms designating the shape, must be understood with some latitude: precision cannot be attained; and in this, the most uncertain of all uncertain climates, one season often proves a fortnight or three weeks earlier or later than another.

and obtusely angular. Eye wrinkled and hollow. Stalk short, and planted in a shallow cavity. Skin of a bright red to the sun; yellowish, marbled with a duller red, from it. Flesh soft, juicy, and sugary. Ripe the end of August, sometimes in use to the end of September. One of the best apples of its season. The tree grows flat-headed, and makes slender declining wood; it is very healthy, and bears abundantly, but principally on the extremities, which renders it fitter for an untrained form than for a trained espalier.

5. **Kerry Pippin*.—A roundish oval apple, about the middle size, with smooth sides, sometimes warted, often nipped at the stalk, which is slender, about 1 in. long, and set in a moderate cavity. Eye broad, shallow, and wrinkled. Ground colour a bright yellow pipped all over, and lightly tinted with red to the sun. Flesh yellow, crisp, and juicy. Flavour sugary and delicate. Ripe in September, and in use to the end of October. An excellent and much admired Irish fruit. The tree makes erect shoots, downy, and, when vigorous, full of spurs; is healthy, and a great bearer.

6. **Aromatic Russet* (Spice Apple of the *Hort. Soc. Catalogue*).—A middle-sized conic fruit, broadest at the base. Sides obtusely angular. Eye wide, shallow, and much ribbed. Stalk long, slender, and set in a deep cavity. The skin, when ripe, a greenish yellow in the shade, to the light a dull red or cinnamon colour, interspersed with much russet throughout. Flesh white, soft, and juicy. Flavour rich, saccharine, and highly aromatic. Ripens in September, and continues in use throughout October; it is one of the best apples in the season, and is here a universal favourite. To its other good qualities it adds those of being a bearer that rarely fails, and a tree healthy in every situation; it makes slender declining shoots.

Kitchen Apples of the same Period, in Succession, as they ripen.—**Keswick Codlin*, *Manks Codlin*, *Kilkenny Scarlet Codlin*, and **Hawthornden*; all well sized, and great bearers.

Supplementary Table Fruit.—*Juneating*, early in August; *Summer Golden Pippin*, end of August; *Sugarloaf Pippin*, August and September; *Bell's Scarlet*, or *Scarlet Pearmain* of *Horticultural Catalogue*, but not of Ireland, September and October. *Orange Apple* of the *Isle of Wight*, September and October.

MIDDLE SEASON APPLES.

1. *White Russet*.—A large fruit of an irregular shape, approaching to oblate rotund. Sides unequal, obtusely angular. Eye large and furrowed. Stalk short, inserted in a large

cavity. Ground colour greenish yellow, clouded with russet and whitish blotches, often delicately tinted with a light blush to the sun. Flesh pale yellow, soft, and mellow; flavour rich and saccharine. In use in October and November, sometimes in December. A fine Irish apple of the first quality, and in great esteem here. The tree grows erect, makes strong shoots of a light grey colour, and has leaves of a pale green; it is rather a thin bearer, but makes ample amends by the size and richness of its fruit.

2. *Scarlet Queening*. — About the middle size, conic, broadest at the base. Sides irregular. Eye small, deep, and wrinkled. Stalk long, set in a large cavity. Ground colour yellow, blotched, and streaked with red. Flesh firm and juicy; flavour saccharine and aromatic. A good fruit; in use in October and November. The tree bears well.

3. *Scarlet Crofton*. A middle-sized flattened apple with circular sides, and a wide and shallow eye, wrinkled and sunk in the head. Stalk short, and set in a shallow cavity. Skin of a bright red to the sun, and yellowish green from it, streaked with russet. Flesh yellowish, tender, crisp, and juicy, never mealy; flavour sugary, vinous, and often aromatic. An excellent Irish fruit, which has no superior in its season; it is in use from October to the end of January, and makes a choice cider. The tree grows flat-headed, with rough, speckled, slender shoots, which bear towards the extremities: this habit, which has a tendency to render the centre of an espalier bare, fits it rather for a standard; as such it bears abundantly.

4. **Sam Young*. — This is a small flattish apple, with an eye remarkably wide, from which the remains of its calyx project; its stalk is short, and inserted in a small cavity. Ground colour yellow, reddish to the sun, mixed with russet, and interspersed with ruddy specks. Flesh yellow, firm, and mellow; flavour rich and saccharine. In use from October to January. An Irish fruit greatly in esteem, but subject to crack from overbearing, unless thinned out. The tree grows dwarfish and spreading, and is very healthy; its leaves are more lucid than ordinary on the upper surface.

5. *Margil*. — A middle-sized conic apple, slightly angular on the sides. Eye wrinkled and small. Stalk slender and deeply set. Surface bright yellow, striped and marbled with red to the sun, sprinkled with darker specks, and a little russet about the stalk and eye. Flesh yellowish, firm, and juicy; flavour vinous, sugary, and piquante. A fruit of the very highest rank in this period of good apples. In use from October to February. The tree grows healthy, and bears

well; makes delicate diverging wood, very downy and full of spurs, and has small lanceolate leaves with long foot-stalks.

6. **Courtwick Pippin*.— On oval fruit, below the middle size; head flatted. Sides smooth, and sometimes warted. Eye large, shallow, sunk, and a little indented. Stalk short, set in a wide cavity, and often oblique. Skin yellow, mixed with russet, and ruddy to the sun. Flesh of a rich yellow when ripe, crisp, and juicy; flavour saccharine, relieved by an agreeable acid. An excellent apple; in use from October to February. The tree makes slender and erect wood, is healthy, and an abundant bearer.

Kitchen Apples.—Leixlip, in use to December; Alexander, to January; *Beauty of Kent, to February; Cathead, to March; Scarlet Admirable and Golden Noble, to March: all large fruit and good bearers.

Supplementary Table Fruit.—Yellow Ingestrie, October to November; Wormsley Pippin, October to November; Downton Pippin, October to January; Braddick's Nonpareil, November to February; Golden Reinette, November to February; Scarlet Nonpareil, November to February.

LATEST KEEPING APPLES.

1. *Ross Nonpareil*.— A middle-sized roundish apple. Sides smooth, sometimes warted. Eye shallow. Stalk about 1 in. long, deeply inserted. Surface when ripe yellowish, nearly covered with russet, and a deep red with darker stripes to the sun. Flesh whitish and firm; flavour sugary and perfumed. In use from November to March. An Irish fruit, in great request here. The tree makes slender wood, spreads in its head, grows healthy, and is a great bearer.

2. *Ribston Pippin*.— A large, oblate, rotund apple; with angular sides, and eye deeply furrowed and closed by the calyx. Stalk short, sometimes elbowed, and deeply inserted. Skin yellow, spotted and striped with bright red to the sun, and blotched with russet, particularly at the eye and stalk. Flesh yellow and firm, sometimes coarse; flavour saccharine and aromatic. A valuable fruit, that maintains its good qualities in almost every situation. The tree grows spreading; its shoots are strong, and very downy at the extremities. This apple is in use from November to April. It possesses so many features in common with the Margil, that it seems most probable that it derives its origin from it; but though it has the advantage in many other respects, yet I think that in flavour it is inferior.

Beauchampwell Seedling.— Below the middle size, oval.

Eye prominent, but placed in a shallow basin. Stalk short, planted in a deep, but narrow, cavity. Surface uniform. Ground colour yellowish green, reddish to the sun, interspersed with darker spots. Flesh yellow, firm, juicy, saccharine, and high flavoured. Keeps to April, and bears abundantly. Wood erect, brownish, and downy; leaves small and oblong, with footstalks long and slender. A choice apple even in bad seasons.

4. *Green Nonpareil*.—A middle-sized, roundish, oblate apple. Sides smooth. Eye shallow. Stalk slender, inserted in a wide and shallow cavity, sometimes elbowed. Surface a yellowish green and dull red to the sun, clouded with russet, and marked with dark specks. Flesh crisp and juicy; flavour saccharine, aromatic, and piquante. The tree makes slender erect shoots, striated or furrowed at the extremities; leaves long oval, with long footstalks. A good bearer, but apt to canker in old garden ground; yet it is a fruit of such superior excellence and high repute, that it cannot be omitted here. In use from December to May.

5. **Syke House Russet*.—Below the middle size, in shape flattish. Eye wide. Stalk short, inserted in a shallow cavity. Ground colour yellowish green, much clouded with russet, and of a dull red to the sun. Flesh yellowish and firm, but mellow; flavour sugary combined with a pleasing acid. An excellent apple, that is in use from December to May. The tree grows spreading, makes gross wood, is healthy, and a great bearer.

6. **Prickly Seedling*.—A small round fruit with smooth sides, sometimes nipped at the stalk, which is thick and set in a wide cavity. Eye large and deep. Ground colour a bright yellow, with a bright red superadded next the sun, and russet about the stalk. The flesh yellow, juicy, and mellow; flavour saccharine and rich. In use in January, and keeps to June. The tree grows erect, is very healthy, and a great bearer.

7. *Reinette Franche à Côtes*.—A large oblong apple, with obtusely angular sides. Eye very wide and deep, irregularly furrowed. Stalk long and slender, deeply inserted. Skin green until quite ripe, then yellowish, with some light reddish stripes to the sun, and specked with russet about the eye and stalk; shrivels a little when perfectly ripe. The flesh is then yellowish, juicy, firm, and mellow; flavour rich and saccharine. In use from January to July. A choice fruit, placed by the French at the head of their best apples. The tree grows very strong and erect, with shoots of a greenish tint and a silky pubescence at their extremities; it bears

leaves of an oblong oval, with remarkably parallel sides, and is an abundant bearer. There is another variety of the R. Franche more round and flat, and of the same quality; but it has not yet borne fruit with me. The merit of these latest fruits is very variable, being in a great degree dependent on the fineness of the latter season, which is naturally inclement.

Kitchen Apples.—Alfreton to May, very large and a good bearer; *Northern Greening, a great bearer, in use to May; Royal Russet, a great bearer, to May; *Hanwell Souring, a great bearer, in use to June; French Crab, Millmount Beaufin, and *Norfolk Beaufin, great bearers, that keep to August, and longer.

Supplementary Table Fruit.—Dutch Mignonne, in use to April; Calville Blanche, to April; Martin Nonpareil, to May; Golden Harvey, to June; Lamb Abbey Pearmain, to May; Beauchampwell Seedling, to May; all good bearers.

I remain, Sir, yours, &c.

Kilkenny, Jan. 16. 1831.

JOHN ROBERTSON.

I have just received the last number of the *Pomological Magazine*, in which the editors announce their intention of suspending the publication. It is much to be regretted that a work which has been so long a desideratum, and has been so ably conducted, should even momentarily cease. If not speedily resumed, it is to be hoped that the Horticultural Society will in some shape supply the loss, if not by a continuation, it may at least by publishing a *Catalogue raisonnée* of such varieties of fruit as have been proved in their garden. Though the fruit department has been held up as the most important of the establishment, it, as yet, has been but lightly touched on in the *Transactions*; but as a great proportion of the collection must by this time have shown its merits, surely our reports on the subject will in future be fuller and more satisfactory. — *J. R.* [See the *Catalogue*, &c. noticed p. 212.]

ART. XVIII. *On a Method of forcing Cabbage Lettuce, practised for many Years at Longleat, by the late Mr. Rutger, Gardener there.* Communicated by his son, Mr. T. RUTGER.

Sir,

THE perusal of M. Lindegaard's article, inserted in Vol. VI., p. 689., on the forcing of cabbage lettuce in Holland, brings to my recollection the method taken by my father, who lived five years in the neighbourhood of Amster-

dam, where he gained the principal part of his knowledge in gardening, and that of framing in particular. The only sort he grew was the Hammersmith hardy, which, under his treatment, far exceeded its usual size when grown in the open ground. Other sorts were tried, but none found to equal this; which perhaps may be accounted for by its being less succulent than most of the other sorts, and thereby better calculated to resist the ill effects of damp, or steam, which might occasionally take place, although the greatest possible care was always taken to endeavour to prevent the latter. His method was as follows:—

In the early part of September the seeds were sown either on a warm south border or in some sheltered situation. As soon as the plants were sufficiently grown, they were pricked out at 3 or 4 in. apart in a cold cucumber frame, where they had the advantage of being covered with the lights, more or less according to circumstances, particular care being taken not to draw the plants by keeping them too warm.

About the time of pricking out the plants, a sufficient quantity of leaves, with one sixth part of long dung from the stables, was well mixed, and thrown together in a heap to ferment, and while in a state of fermentation a six-light bed was made of about 3 ft. in height, and well beaten while making, so as to make it as compact as possible, which prevented the heat from rising to more than milk-warm. The compost used was a mixture of old melon and cucumber mould, one half of each. This was introduced into the frame to about 10 or 12 inches in depth, and beaten down during the operation so as to make it tolerably compact. As soon as the heat rose, which was always of the most gentle kind, the surface was covered with tolerably dry sifted mould, about an inch thick, and smoothed down as level as possible. This being done, a rod or straight-edged piece of wood was used so as by pressure to make lines on both the long and cross way of the bed, so contrived as to intersect each other exactly under the middle of each pane of glass. Great care was then taken in making the best selection of strong healthy plants from the nursery bed, and also in taking them up with good balls; and after carefully displacing any decayed leaves that might be found at the bottom of the plants, they were planted at the intersections of the lines in the bed prepared for them; thus presenting, when the lights were on, a plant under each pane of glass. This operation took place in the first week of November. Another bed of nine lights long was in the mean time preparing to be planted out, in the last week of November. It was an every-day practice, for several weeks

after planting, to observe if any of the plants suffered either from steam or the wire-worm, to replace such plants as had been injured, and to remove decayed leaves, &c. ; but, as the least steam is injurious, great care was taken in giving a due proportion of night air, even after it became necessary to cover with mats, which was done by tilting the lights, and letting the mats hang over, and tacking them to the frame below the opening where the air is given.

At the latter end of December a stiff lining was added of the same proportions of dung and leaves as the bed was made of, by which means a very gentle heat was kept up, during the two following months.

About the middle of January the lettuces began to come in, generally to the admiration of every one who saw them ; and it was scarcely believed, even by gardeners, that they were of the sort above named.

Before I close this article, I would further observe that the plants were only once watered, viz. at the time of planting, and then not over the leaves ; and that the mould was raised just so high in the frame as to give sufficient room for the growth of the plants without their coming in contact with the glass. A free circulation of air was admitted in dry mild weather ; and great care was taken that they should never get injured by frost.

A crop for cutting in November and December was also grown in a manner somewhat similar to the method described by M. Lindegaard, the seeds were sown in August.

The above practice was carried on at Longleat, by my father, who lived in the service of the late Marquess of Bath for, I believe, nearly thirty years.

I remain, Sir, yours, &c.

Longleat, Dec. 1830.

T. RUTGER.

ART. XIX. *On a Mode of cultivating the Tomato, so as to make sure of ripening the Fruit without artificial Heat.* By E. S.

Sir,

IT having fallen to my lot to be placed in situations requiring a good supply of love apples, I have been induced to try a variety of methods to bring them to the greatest degree of perfection. I have no doubt you are aware that it is very difficult to persuade some persons to forsake their old mode of culture to practise a new one ; nevertheless, if you think what I am about to communicate worth insertion in your next

Number, I am certain there are some among your numerous readers, who, seeing it there, will not hesitate to try it; and that, in a short time, we shall not (at least in this part of the country) hear of people being obliged to cut the fruit, and hang it up in a warm room to ripen. Sow the seeds thinly, either in pots or pans, about the 1st of February, in a warm frame, or house; and as soon as they appear above ground, let them have as airy a situation as possible, to prevent their drawing up weak. When they have partly made two leaves, besides their seed leaves, let them be pricked into pans about 2 in. apart each way; and, when they begin to get crowded, pot them into 60-sized pots, one in each pot; afterwards shifting them, so that their roots may not become matted in the pots, and giving plenty of water. When the weather is warm enough, plant them out in the garden, one in each place (if against a wall or broad fence the better, but they will succeed as espaliers). Train the stem of each plant upright (without stopping), and the side shoots horizontally, about a foot apart, using the knife as little as possible. By growing the tomato plant as large as possible before planting out, they have the advantage of the summer for ripening their fruit, and by planting only one in each place, the small space usually left between the fruit trees may be used for them. Whereas by growing them three in a pot (as usually practised) they take a great deal of room, and require continual cutting, which causes them to push afresh, instead of blossoming and ripening their fruit. By training the plants horizontally at the above distance, they enjoy plenty of sun and air, and do not grow so strong as when too much pruned. I am, Sir, yours, &c.

Tottenham, December 24. 1831.

E. S.

ART. XX. *Abridged Communications.*

BRICK Tallies printed upon before they are baked. — I have seen flower-pots made, upon which numbers were marked, in regular succession, from No. 1. upwards; and they were, of course, as lasting, and as imperishable from wet or weather, as the material upon which they were impressed. The stamps for this purpose were cut on wood; and, consequently, as far as numbering alone is required, they were done cheaply and readily enough. Now, it appears to me that even the printing of the names of plants might be executed in a similar manner, at as small an expense as is now incurred for painting or marking upon the tallies at present in use. It would

only be necessary to have some sets of letters, of the size wished, cut upon blocks of wood; and the sole additional requisite would be, that the blocks should be of one length, and straight on the sides: the letters could then be picked out as readily, and placed as evenly, as the present printing letters are; and might be held together, during the time of marking, by any of the well known modes of compression.

Allow me, also, to suggest that all the iron punches made in future, with either letters or numbers, should be made straight-sided. It would then be easy to put two or three, or more, letters together, side by side, and to make impressions upon lead or copper with them, in a neat and even manner; whereas, at present, from the bulging sides of the punches, they must be used one at a time; and, when thus used, it is difficult to make the letters of the same depth; or even in a straight line. — *R. Feb. 17. 1832.*

To repair and improve Lawns without the Aid of Turf. — In the metropolis and its neighbourhood, the turf laid down in small gardens seldom lasts more than one season; and requires to be renewed at an expense, including the purchase of the turf and laying it down, of from 3*d.* to 4*d.* a square foot. Instead of being at this expense, if the ground to be turved were to be stirred up to the depth of 3 in. or 4 in. every spring, in the last week of March or the first week of April, and thickly sown with the following seeds, it would soon become green; and, if regularly sown, will remain as close and thick as any turf whatever during the whole summer; dying, however, in the succeeding winter, and requiring to be renewed in the spring.

The grasses used for this purpose are: — *Agróstis vulgàris* var. *tenuifolia*, *Festùca duriúscula*, *Festùca ovina*, *Cynosùrus cristàtus*, *Pòa praténsis*, *Avèna flavéscens*, and *Trifòlium mìnus*. These seeds are mixed together in equal portions, and are sown at the rate of from 4 to 6 bushels per acre.

In lawns and shrubberies in the country, the turf frequently fails under large trees and in various other places. There is no cheaper or better mode of making good these defects, than by sowing the above mixture as early every spring as the situation and the soil will admit. Of this there is a proof at Clarence Lodge, Rochampton; where the very intelligent gardener, Mr. Henderson, at the suggestion of Mr. Sinclair of the New Cross Nurseries, has practised this mode with the greatest success for two years. — *R. S. B. March, 1832.*

REVIEWS.

ART. I. *Transactions of the Horticultural Society of London.*
Second Series. Vol. I. Part I. 4to. London, Hatchard.

1. *A Report upon the Varieties of the Pine-Apple cultivated in the Garden of the Horticultural Society.* By Mr. Donald Munro, F.L.S., Gardener to the Society. Read Dec. 7. and 21. 1830, and Jan. 4. 1831.

IN the year 1828, the collection of pines in the Chiswick Garden, procured from home and foreign correspondents, had increased to 450 names; but so great a number of these were duplicates, that Mr. Munro has reduced them to 52 distinct sorts. In order to facilitate their discrimination, he says:—

“I have first separated the kinds reputed to be species, which are readily known by their peculiar habit, and I have then distributed the varieties of *Ananassa sativa*, or the true pine-apples, in classes and divisions, characterised by such distinctions as have been found, by experience, the most permanent. After much consideration, it has been determined to employ the different degrees of serrature in the leaves, as the primary mode of division, because it is they that cause, in the greatest degree, that natural habit of the varieties, by which a practised eye will recognise them without an inspection of the fruit. The groups, so formed, are the least artificial that could be discovered, for the form of the fruit and colour of the flowers, although excellent marks of distinction, separate varieties which are almost identical in their general habit; for this reason such characters have been admitted as only of secondary importance.

“The whole of the means employed in drawing up this paper have been derived from notes made at the garden, during the last five years, upon plants and fruit, in all cases carefully and repeatedly compared in every stage of their growth.

“To Mr. James Duncan, the present under-gardener in the forcing department, a young man of extensive practical knowledge, I am much indebted for assistance in arranging and drawing up the descriptions.”

Classification.—The species are *Ananassa bracteata*, the scarlet; *A. debilis*, the waved-leaved; *A. lucida*, the shining, or *king*; and *A. sativa*, the cultivated, which includes forty-eight varieties; which, with the four species not cultivated for their fruit, make up the fifty-two distinct sorts before-mentioned. We do not think it worth while to give their names, which, with their characters and synonymes, will be found in the Society's *Catalogue*, second edition, noticed p. 212.; but Mr. Munro has very judiciously given at the end

of his paper a selection of the best sorts for cultivation, with short notes upon their comparative qualities, and this we shall lay verbatim before our readers, as of much practical utility.

“ *The Queen* is one of the best varieties at present known for general cultivation. It grows freely, fruits early, and, although not so high flavoured as some of the larger kinds, is still the most valuable for a small family. Exposed to a very high temperature in the months of June, July, and August, it is liable to become hollow near the core; but early or later in the season it is not subject to that defect. It is the sort generally grown by gardeners for the London market. *The Ripley's Queen*, a slight variety of the common queen, is probably the best; the leaves are greener and broader, and it does not throw up so many suckers.

“ *The Moscow Queen* is an excellent variety, but is rather a slow grower; the fruit is about the same size as the common queen, but superior to it in flavour.

“ *The Black Jamaica* is an excellent fruit at all seasons of the year, but particularly in the winter months, when pines rarely come to perfection; it cuts firm to the core, is highly flavoured, keeps some time after it is fully ripe, and bears carriage better than any other. It is, however, rather a slow grower, and the fruit seldom attains a large size.

“ *The Brown Sugar-Loaf* is the best of the sugar-loaf kind: it is a large, handsome, and highly flavoured fruit, swells freely in the winter months; its flesh is firm and juicy.

“ *The Ripley* is large, handsome, and high flavoured; it is a good summer fruit, and swells freely in winter.

“ *The St. Vincent*. The fruit is not large, but highly flavoured, particularly in summer, and it is said to swell freely in winter.

“ *The Black Antigua* is an excellent and highly flavoured pine, if cut when it begins to turn from green to yellow; but, if allowed to remain on the plant until it is quite ripe, it loses all its richness.

“ *The Enville* is deserving of a place in collections, as one of the handsomest pines in cultivation; although it is neither rich nor highly flavoured.

“ *The Lemon Queen* is of free growth; the fruit is rich, juicy, and high flavoured.

“ *The White Providence*, when grown to a large size, is generally deficient in flavour, but it is a very handsome showy kind. It may sometimes bear prematurely; and, if in that case the fruit be allowed to become perfectly ripe on the plant, it is equal in flavour to a queen.”

(*To be continued.*)

ART. II. *Memoirs of the Caledonian Horticultural Society.*
Vol. IV. Part II.

(*Continued from Vol. VII. p. 593.*)

52. *Hints on the Management of the Grape, and particularly in Peach-houses; and on propagating Vines by Layers and Cuttings.* By Mr. John Martin, Gardener at Kirkton Hall. Read March 8. 1814.

“ ANY one that is curious to have vines in pots full grown, should, at the time of pruning, take the stem through the

hole in the bottom of the pot, and lay the rest of the vine from the bottom of the pot in the ground: they thus shoot much sooner. For such purposes, I take the old shoots that are to be cut out that season. For the pots, I use the same compost as for the border. I always keep rotten dung about the pots, as it makes the vines strike much sooner than keeping the pots dry. I have had twenty-six good bunches in a pot, and could have had more but for thinning. When the fruit is at maturity, I cut the old bunch by the bottom of the pot, and remove the plant at pleasure for ornament.

“ I have often taken notice that, in some sorts of vines, the foliage turns brown, just as if it had got a little frost. Such vines are generally on a clay soil, or on a bottom that does not let the roots push freely, so causing a stagnation of the sap.”

53. *Notice of a Hawthorn Hedge, damaged by Æcidium laceratum.*
By Mr. Wm. Don, Hull. Read June 14. 1814.

The hedge which surrounds the Hull Botanic Garden was planted in 1812; and, in the summer of the same year, “singular brown swellings” were found on the young shoots.

“Those protuberances, for the most part, occur in the middle of a young shoot, but sometimes towards the end; and vary in number from one to three, or more, on each shoot; frequently, even the leaves are similarly affected. Their most usual shape is oval; but they are often singularly curled and distorted. In size, they vary from that of a bean to that of a walnut. Exteriorly, they are sometimes smooth, but commonly present a brown shaggy appearance; which, when examined with a magnifying glass, is found to arise from numerous minute and thickly set orifices, each surrounded with many leaves, and containing a brown powder, which at one time was so abundant as to make a visible cloud when the hedge was shaken. Interiorly, they are solid; but of a less consistent and more brittle substance than the rest of the shoot, without any appearance of being inhabited by insects of any description.

“With respect to the nature of these protuberances, there seemed every reason, from the brown powder, to believe them to be fungi of some kind; and specimens having been sent to Mr. Sowerby, that celebrated artist and botanist stated them to be *Æcidium laceratum* of his *English Fungi*, table 318.; adding, that ‘*Æ. cancellatum* (t. 409. of the same work) attacks pear trees, and often prevents valuable crops.’

“Though I have made diligent enquiry, I have not met with any one who has before observed the disease in this neigh-

bourhood; and, what is remarkable, though the quick wood was all from the same nursery, and planted at the same time, it is entirely confined to the hedge on the west side of the garden, and chiefly to about 100 yards in the middle of it. On the east and south hedge, I have never discovered a single protuberance."

54. *On the Curl in Potato, and on the Transplanting of Onions.* By Mr. Peter Lowe, Gardener at Torwood Lee. Read March 8. 1815.

Curl. — Keep the tubers intended for seed free from wet or damp, either in a house or in pits. "Generally, at the root end of the potato, or what some call the waxy end, almost close by the feeding string, there is an eye, which, cut by itself, mostly produces a curl, unless it has another eye in the cut or set; which other eye generally springs first, and stops the former from growing: except in the foresaid cut, I recommend only one eye. By attention to this, this season I could have shown a whole break, and scarcely a curl in the whole break: they were early potatoes, which are more given to curl than the late sorts."

Onions. — Sowed for the ensuing winter in the end of July; transplanted from them, where too thick, next April; and had a good middle-sized crop, which kept through the year better than those sown in March in the usual manner.

55. *Some Account of the Fruits grown in Gourdie Hill Orchard, Carse of Gowrie, with Remarks.* By Patrick Matthew, Esq. Dec. 3. 1827.

Winter apples, 77 sorts; winter pears, 5 sorts.

56. *On the Means of Renovating Plantations of Asparagus, and on the Utility of Top-Dressings.* Read Sept. 7. 1816.

Take off the old surface between the rows, and substitute a new one of light rich soil. "I am convinced that top-dressing is as essential to asparagus, as the preparation of the ground for its reception either at the time of sowing or planting."

57. *Account of a Collection of Gooseberry Bushes, contained within an Enclosure in the Nurseries at Perth.* By Archibald Turnbull, Esq. Read April 20. 1826.

Very extensive, and "not a bad sort in the collection."

58. *Account of the Mode of making various Liqueurs, &c.* By Mr. Lewis Pederana. Read Dec. 6. 1827.

Mode of making Home-Brandy. — Take 20 pints of fully ripe gooseberries, and 20 pints of white or red currants;

bruise them, and mix with 20 pints of soft water, and 2 gallons of port wine; and if you choose to make the brandy of Scotch production, instead of port wine make use of whisky; but the port wine is preferable, as it gives the flavour of French brandy. Put these ingredients into any open vessel to ferment for a fortnight; then put the mixture through a press, or cloth of any kind, that will exclude the refuse; distil this liquid twice, and you will have the brandy colourless. From every 20 pints of the mixture you may draw 10 pints of good brandy. I need scarcely add, that, to colour it, a little brown sugar, burned, may be made use of. This spirit, in the manufacture of liqueurs, I have found superior to mixing with other spirits.

Mode of making Gooseberry Wine. — Take 40 pints of fully ripe white or yellow gooseberries; bruise them well; add 20 pints of soft water, and 60 lbs. of loaf-sugar. Put them whole into any open vessel (say, a cask without the end); stir them together, until the sugar be entirely dissolved. Let the whole ferment for a fortnight, and the refuse will separate. Then make a perforation or hole within 2 in. of the bottom; draw off the liquid, which you will find as pure as water. Put the liquid so drawn off into a cask large enough to admit of the spirits; and to every 20 pints of wine add three pints of the distilled spirit or brandy. Let it stand in the cask for five or six months, then bottle it; and, in half a year, you will find it similar to Mosellas, and far preferable to many of the sweet made wines.

Mode of making Crème de Rose. — Put 4 lbs. moss-rose buds into 10 pints of good whisky; let them stand for six weeks, shaking them twice every week; then squeeze the rose leaves from the spirits. Put the leaves thus squeezed into six pints of water, wash them well, and squeeze the liquid into the spirits: pass them through the still once, and, if it is not strong enough, put it through again. Then take a preserving-pan, put into it 6 lbs. of bruised loaf-sugar, 2 quarts of water, and the white of an egg beat up to a froth; mix them thoroughly; put it over a stove fire, taking off the scum as it rises, until it becomes quite clear. Then let it boil slowly, until reduced to a pretty thick shrub, taking care not to boil it so long as to colour the sugar; pass your shrub through a jelly-bag, and put it into any open earthen vessel to cool. Then, to every quart of shrub thus prepared, put a quart of spirit of rose, mix them well together, and, if clear enough, bottle it; if not, pass it through the jelly-bag till it becomes so, and you will have Crème de Rose.

Mode of making Crème de Moka. — Take 1 lb. of the best Mocha coffee, ground; put it into 4 pints of water; let it boil in a goblet or pan, over a slow fire, for ten minutes, to draw out the essence; then pass it through a flannel bag. Then put it into a small still, with a pint of gooseberry brandy; pass it until it becomes strong enough. Make a shrub for it as for Crème de Rose, and, when cold, mix in the same proportion, and you will have Crème de Moka.

Mode of making Kirschwässer. — Take any quantity of fully ripe geans [wild cherries] and cherries, and, in a mortar or wooden tub, bruise kernel and pulps. To every 20 pints of bruised fruit add 5 pints of water and 2 pints of gooseberry brandy; mix them, and let it ferment for a fortnight; squeeze out the liquid, put the refuse under a press, to express the remainder, which is the best. Then put the whole into a still; pass it twice; and, if it is not strong enough, again; and you will have it as good as Swiss Kirschwässer.

Mode of making Cassi. — Take two pints of raspberries, two pints of black currants, two pints of red currants, two pints of water, and 20 lbs. of brown sugar; put them into a preserving-pan, without bruising; let them boil for half an hour, taking off the scum as it rises. Then put it into any earthen vessel, until next day, or till cold; then add four pints of gooseberry brandy; and, after being mixed, put it into a cask or large jar, for six weeks. Then pass it through your jelly-bag, when you will find it clear as claret; bottle it, and in six months it will be perfect.

Mode of making Nonpareil. — Take a fully ripe pine-apple, and pare off the outside skin; bruise it in a mortar, add one dozen and a half of sharp ripe white magnum bonum plums, and one dozen of jargonelle pears in the same state, quartered; then to every 4 lbs. of fruit add 6 lbs. of loaf-sugar, and 3 English pints of water. Put the whole into a preserving-pan, and boil them for three quarters of an hour, taking off the scum as it rises. Then put it into a can or jar until cold, add three quarts of gooseberry brandy, and let it stand for six weeks; then pass it through your jelly-bag, and you will have the above fine liqueur.

Mode of making Admirable. — Take the outside skin from two dozen of fully ripe peaches; quarter them, and take out the stones; add to this the pulp of two dozen of ripe green gage plums, and one dozen of white magnum plums; then to every 4 lbs. of fruit add 6 lbs. of sugar and two quarts of water. Put the whole over a slow fire for half an hour, taking off the scum; cool it as formerly, and mix with spirits in the same

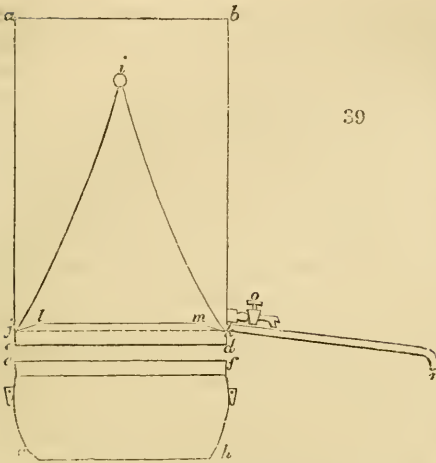

39

proportion. The liqueur which results will be found to deserve the name of Admirable.

Mode of making Sublime de Variété — Take equal quantities of Noyau, Crème de Rose, and Admirable; mix them through a silk sieve; then bottle, and you will have an excellent variety.

The following is a description of the still

(fig. 39.) used in the manufacture of these liqueurs: —

a b c d, Tinned-iron stand for the cold water, and fitting closely on. *e f g h*, Copper, or boiling-pan. *i j k*, Condenser. *l m j k*, Receiver of condensed spirits. *k n*, Rod for conducting off the spirits. *o*, Cock for shifting water in the stand.

59. *Account of Fruit Trees trained to a Wall inclined to the Horizon, at an Angle of about 10°, in a Garden at Portobello.* By Wm. Creelman, Esq. Read Nov. 6. 1828.

This garden being of an uneven surface, advantage was taken of a spot highest in the centre to form two sloping or almost horizontal walls. The trees planted on these walls were chiefly apples and pears: in 1828 they had been planted four years, and were singularly productive. “The apples are of uncommon size: this, I think, is owing to the sun’s rays being earlier received, and retained to a later hour, than on perpendicular walls. The bricks lying on their bed, get more heated than in upright walls; and, by this means, contribute more to the size and quality of the fruit.”

60. *Postscript to Dr. Wm. Howison’s Paper on the Culinary Vegetables of the Russian Empire.* By Dr. Howison.

To salt the Russian Cucumber. — “Wash the cucumbers clean, put them into a keg, pour a pickle of salt and water upon them, till the keg is full. The general quantity of salt is about $4\frac{1}{2}$ oz. to each gallon of water. The universal seasoning is dill tops, before the seeds are ripe, with black currant and oak leaves. People of more refined taste add some garlic, horseradish, and even sweet herbs; but the last very sel-

dom. The keg must be hermetically secured, to exclude the air; and must not be too large, as, the sooner used after being opened, the finer are the cucumbers.

Preserving Culinary Vegetables through the Winter. — Cabbages are preserved in the gardens (set close together, to save room), by building a roof over them of old boards, covering them with the old dung of the hot-beds, or the cleanings of the gardens, and then shovelling over all the earth from the adjacent beds. If the ground is dry, and it is possible to dig downwards, the house (if so I may call it) will be warmer; but the best situation is the brow of a hillock. Two tubes or chimneys are adapted to let out the confined air, when it thaws, or towards spring. Leeks, celery, in short all similar vegetables, may be preserved in the same way. The chimney must be stuffed up when it freezes.

The following is the mode of preserving French beans, parsley, celery leaves, and spinach, through the winter: — Gather the leaves or beans without washing them; put them into a barrel without a head, alternate layers of vegetables and salt. Then put a board upon the vegetables, and a weight upon the board, which will now be covered with the juice of the vegetables. When wanted for use, take out the quantity required, and wash it carefully, retaining the board and weight. The best weight is a clean water-worn stone, tolerably heavy. The watery juice toward the board excludes the action of the air, and prevents putrefaction.

Parsley, celery, and spinach leaves, carefully dried and kept from moisture, are excellent for soups, &c.

61. *On the Kinds of Grape Vine best suited for Hot-house Walls in Scotland.* Read Nov. 2. 1827.

Mr. Shields recommends the White Muscadine and Black Hamburgh, and, next to these, the early July Black Cluster, for a flued wall. A medal was awarded for the specimens of fruit sent.

62. *On the Use of Hop Tops as a Culinary Vegetable, and an Account of different Modes of dressing Gourds for the Table.* By Mr. Lewis Pederana, Halyburton House. Read Sept. 18. 1828.

The hop forms an excellent substitute for asparagus, and the tops may be had the whole year round. “Hop tops also form an admirable ingredient for a variety of dishes, such as soups, omlets, &c. Long experience in the practice of cookery, both in this and in my native country, for upwards of forty years, makes me bold in recommending hop tops. I was for some time in the kitchen of the king of Sardinia, where the

art was practised in all its branches. I was afterwards thirty-four years with the Hon. D. F. Halyburton as cook and house-steward. He being of delicate constitution, and eating no sort of animal food whatsoever, I was, on his account, obliged to study varieties of vegetable dishes. Hop tops formed one on which I by chance stumbled, and of which he very highly approved, finding it agreeable and very wholesome."

To cook the Potiron [Mammoth] Gourd when fresh and fully swelled. — Cut the gourds into slices; and, after paring off the skin, put the slices into a panful of gravy, and, on the fire, boil them down to rag; then pass them through a hair-sieve, and season with white pepper and a little salt; put over the fire again, and boil slowly for half an hour. Then, in a tureen, put a handful of grated Parmesan cheese, upon which pour the soup; mix them well together, then serve up. It will form an excellent dish, and give great satisfaction.

On frying any kind of Gourd. — Slice them thinly half an inch broad, and eight inches long; put them, so sliced, into a sieve or cullender; sprinkle a little salt over them, and let them drop for three or four hours to drain the juice; then put them on a cloth to dry; and, when a little dry, sprinkle some flour; and, a few minutes before dinner, fry them in hog's lard until they get brown and crisp: then serve them up. When scant of other vegetables, this will supply a good dish.

To make a Soup of Gourds, similar to Soupe à Loraine. — When the gourds are young and tender, slice them as above for gravy soup; take two quarts of new milk; put the milk and gourd, so sliced, into a stewpan; and, on the fire, boil them so as they would pass through a sieve. Then, if too thick, add a little more milk; boil slowly over the fire for half an hour; then, just before using, take a mutchkin [pint] of fresh cream, and the yolks of six eggs; mix them all well for a few minutes over the fire; then season with nutmeg, and serve up.

To make Maigre Soup of Gourds. — Take a dozen of fish-heads; and, if you are boiling fish, keep the liquor; put all the heads into it, with a small bunch of celery, parsley, and onions, with a carrot and turnip sliced. Let them boil down to rag; then pass through a sieve; add a small quantity of the gourd, sliced as before. Put them over the fire, and boil, so as the soup may pass through the sieve again; put it into your pan; and, on the fire, season it with a little Cayenne and white pepper, and you will have a very fine soup, equal to gravy soup.

To make Soup of Gourd Tops. — Take a quantity of fresh tops of the shoots or stems; cut them in short pieces; par-boil them, and drain; then, half an hour before dinner, put

them in a stewpan full of gravy over the fire, and boil them slowly for half an hour. Put in a few dice of toasted bread, and you will find this an excellent dish.

Another useful Dish with Gourd Tops. — Collect enough to make your dish; give them a half blanch; then put them in a sieve or drainer, with a sprinkling of salt. After the first course goes up, lay them in a good batter, fry them in hog's lard, and serve them up.

A good Dish with newly-set Gourds. — Gather a dozen of very young gourds when thoroughly set; take out the pulp from one end with the turnip-cutter; give them a parboil; fill the shells with good forced-meat, such as you would put in pâtés; take two ounces of fresh butter and a little flour in a stewpan, and dissolve them on the fire; then add some gravy, and make pretty thick with the yolks of two eggs, and a little Harvey sauce. This will form as fine a corner dish as can be produced at table.

To preserve any kind of Gourd. — Cut off the top and bottom of the gourd; then cut it in rings, and pare off the skin, and, in thin slices, cut the rings longitudinally; dry them in the kitchen, on sticks, or on the skreen: when dry, they will keep for years. When you wish to use them, steep in milk-warm water for three or four hours; then dry them on a cloth: when dry, put them in a sieve or drainer, and sprinkle some flour over them; sift out the flour; then fry them in hot hog's lard. This makes an admirable second-course dish.

To dress young Gourds; another of the same. — Take young gourds, the size of cucumbers; cut them longitudinally in four; clear them of any pulp; if very tender, give only a parboil, and, if hard, blanch them with a little salt: then take 2 oz. of fresh butter, and a tablespoonful of flour, which brown in a stewpan, and pour on good gravy until pretty thick. Put the gourds in this mixture; season them with white pepper, and a little salt, and serve up. This makes an excellent centre or corner dish for the second course.

Take young gourds, as above, and likewise butter and flour as above; dissolve the butter in a stewpan, but do not brown it; then take three yolks of eggs, mixed well with half a mutchkin of cream and half a mutchkin of sweet milk. Stir this before the fire until it becomes thick as custard: if not thick enough, add one or two yolks of eggs more; season it well with pepper and nutmeg. Then put it neatly on the dish, with all the sauce; strew over it a handful of grated Parmesan cheese; then put it in the oven to brown, or salamander it. This dish is one of the best of vegetable luxuries,

and will defy the person who eats to say of what it is made, unless he has previously known it. This is likewise a second-course dish, and may be placed opposite the above.

(*To be continued.*)

ART. III. *Verhandlungen des Vereins zur Berforderung des Gartenbaues in den Königlich Preussischen Staaten. Transactions of the Society for the Advancement of Gardening in the Royal Prussian States.* 4to. Vol. II. Berlin, 1826.

(*Continued from Vol. IV. p. 252.*)

1. *On the Making of Fruit Wines.* By M. Nathusius, at Althaldensleben.

AFTER several years' experience, M. Nathusius recommends to add a quantity of sugar to the juice, so as to bring it equal in specific weight to the grape wine, which is about 7 or 8 per cent heavier than water; while the juice of any other fruit is only from 5 to 6 per cent heavier. The must begins to ferment in an open tub very soon without yeast, and ought to remain there until its specific weight is half diminished, when it is put into a cask, where a little fermentation continues more than a year. Every five or six months it must be drawn off. In the second year it begins to become clearer, and in the third year it will be quite clear, and may then be kept for one hundred years, when properly preserved. It has an advantage over grape wine, as it does not mould, even when in a bottle, and exposed to the air. He observes, that, when the juice of apples ferments without the addition of sugar, the acid of the apples generally turns to a kind of vinegar, which is not only unpleasant, but also unwholesome. The juice of apples, even when sugar has been added, is not equal to that of grapes in flavour; but, by adding a due quantity of wine-acid, the cider will be very similar in taste to wine, though without the aroma which is peculiar to grape wine.

8. *Extract from the Transactions of the Meeting of Feb. 8. 1824.*

Twelve bottles of different sorts of fruit wines were exhibited by M. Nathusius, and it was generally allowed to be the best ever made in Germany.

9. *Extract from the Transactions of the Meeting of March 7. 1824.*

A field bean was exhibited by M. Tenke of Karisch, which had produced seven stems, eighty-six legumes, and

two hundred and eighty-six beans. Two of the stems were 5 ft. high, and the rest from 2 to 4 ft. A sort of protuberance was formed above the roots, which was occasioned by the plant having been broken, or bruised, when quite young.

10. *On the Vegetation in the Neighbourhood of Rio de Janeiro.*
By M. Beyrich.

Though the country in question is now generally cultivated, it may be still seen that a forest originally covered the whole. Loam is the principal soil, in which the various trees of those forests flourish luxuriantly; and whilst some are clothed with leaves and flowers, others appear to be in a state of rest. M. Beyrich mentions the singular circumstance, that, when one of those original forests is hewn down and burnt, the succeeding vegetation consists of quite different kinds of plants from what formerly existed; but he does not attempt to account for this occurrence.

11. *Extract from the Transactions of the Meeting of May 4. 1824.*

M. Otto proved, on M. Host's authority, that maroschino (a kind of cherry brandy) is made from the fruit of *Prunus bis-flòrens* (twice-flowering plum), which grows wild in the neighbourhood of Zara, and not, as it was generally believed, from *Prunus Mahaleb* (now *Cerasus Mahaleb*). M. Lenné gave an account of the improvement of the National Nursery, which contains 340 sorts of apples, 236 of pears, 98 of plums, and 100 sorts of cherries; and promised to give a more particular account at a future time.

12. *Observations on the Culture of the Genus Amarýllis.*
By M. Otto.

When the bulbs begin to grow, more water is given them, and, if required, larger pots. If they flower before the leaves appear, they must be repotted after they have ceased flowering; but no roots should be cut off, except those which are dry or rotten. The size of the pots depends entirely on the size and growth of the bulbs; and some of them may remain several years in the same pot. Sufficient moisture can be supplied to the roots, by putting the pots in a pan, filled occasionally with water, which gives the bulbs more strength, and is more likely to save it from rotting, than when the water is put, as usual, on the top. The soil in which they are planted is composed of one part of loam, which does not contain oxide of iron, and two parts of leaf mould. Small stones must be put in the bottom of the pot, to facilitate the passage of the water.

M. Otto disapproves entirely of the practice of taking up the bulbs, and drying the roots, as they not only become weaker, but are more liable to rot; neither will they flower sooner, as some believe. *Amaryllises* cultivated in this way will sometimes flower twice in a year, and the bulbs are always found to be very healthy and strong.

14. *Opinion of the Committee on different Papers.*

M. Bouche, nurseryman at Berlin, gave an account of a *Ròsa turbinàta*, in his garden, which produces four thousand blossoms: it was trained on an espalier frame, of which it covered 112 sq. ft.; and he recommends this species particularly for making rose water, on account of its strong scent. [This is one of the most vigorous-growing kinds of rose which British collections yet contain, and is fit for coarse shrubberies. It bears a profusion of flowers, but these are usually one-sided and misshapen. Many possess *Ròsa turbinàta*, perhaps, unconsciously: it is remarkable for its large turbinate (that is, top-shaped) calyx, and the English name for it is the Frankfort Rose. — *J. D.*]

16. *A Method of protecting the tender Kinds of Rhododendrons, Roses, and other Shrubs, in the open Ground, from very severe Frosts.* By M. Bosse, at Oldenburg.

Stakes are fixed round the plants, and willow rods loosely woven among them; on the outside of this basketwork another must be made, at about 8 or 10 in. distance, and the space between the two circles filled up with leaves or moss. A cover is made like a straw roof; and, by being larger than the external basket, serves to keep the wet from it. The bottom, in the inside, must be covered with leaves. In fine weather air may easily be given, by taking off the straw cover, and the plants will remain green and healthy. Tender climbing plants may be protected, by fixing them round the inside of the basket.

17. *On Amariyllis gigantèa, and its Culture.* By M. Schneevogt, at Haerlem.

This plant flowered first in the year 1805, in Holland, where it had existed for sixteen years without being known, in consequence of its not flowering. M. Rosenkranz was the sole proprietor of this *Amariyllis*; from which only a few were propagated, till, in the autumn of 1820, several English nurserymen announced it for sale, but at a very high price. After this M. Schneevogt received some of these bulbs from the Cape, in a season when it was too late to plant them in what is called in Holland a Cape frame; he

therefore planted them in pots, and placed them on tan in a pinery, where they soon began to vegetate, and flowered beautifully; while those which were kept colder did not flower at all. This caused M. Schneevogt to think that this species of *Amaryllis* does not come direct from the Cape, but is brought from the interior of the country, where the climate is considerably warmer; and he was confirmed in his opinion by conversing with several of the inhabitants of the Cape, who, upon seeing the figure of the plant which had flowered in Holland, did not remember to have ever seen it before. M. La Brousse, who travelled over a great part of Southern Africa, never saw this plant, until he purchased some bulbs from the Caffres, who informed him that they were found far in the interior. The supply of water given to these plants depends entirely on their growth, and other circumstances; as season, warmth, &c. M. Schneevogt also cultivated several other bulbs from the Cape, as *Brunsvigia falcata*, *multiflora*, &c., in the stove with equal success.

18. *On the Zizania aquatica.* By M. Otto.

This plant has been cultivated in the botanic garden at Schöneberg, near Berlin, since 1818. The seeds were received from North America, in a bottle filled with water; which is the surest way for transporting seeds of bog plants safely. A correspondent of M. Otto made the following remarks on the culture of this plant. If the seeds are dropped into the water of a pond or bog, they will vegetate at the proper season, and their produce will be particularly satisfactory to those who now collect the *Glycèria fluitans*; as the grains are not only larger, but they have also more nourishing qualities in them, and have an excellent flavour. They are particularly good to fatten fowls with. *Zizania aquatica*, or Canada rice, grows in Canada, in boggy places, where it sows itself plentifully (although a great deal is gathered for use), as the least agitation of the stem causes the seeds to fall, even before they appear to be ripe. [*Zizania aquatica* is successfully cultivated in some British gardens; as formerly at Sir Joseph Banks's, and now in the Cambridge Botanic Garden. Waterfowl, as ducks, are so very fond of the herbage of this plant, as to render the establishment of it in ponds where ducks visit a matter of difficulty: this was proved in an attempt to establish it a few years ago, in water, on the estate of Lord Calthorpe, at Ampton, near Bury St. Edmunds. — *J. D.*]

23. *Observation of M. Lenné on the Opinion of M. Manger relative to the Formation of a Nursery for each Province, to serve as a*

Standard, from which to procure good sorts of Fruit Trees to plant on the Road Sides.

24. *Meeting of the Society of June 11. 1824.*

Robinia Pseud-Acacia is recommended to be planted on poor sandy soil, where no other tree will prosper; also for its very durable wood, which, in France and on the Rhine, is preferred to any other for stakes.

25. *Observations on the Slope of the Roofs of Hot-houses.*
By Professor Link.

M. Link says that the direction in which the rays of the sun fall upon the roofs of hot-houses is of less consequence than is generally supposed, provided the plants have as much light as possible, particularly from above.

26. *Germination of the Seeds of Tectona grândis.*

Dr. Kielmayer, from Würtemberg, who has sent seeds of *Tectona grândis* (teak-wood) to the Society, gave the following account of the method used at Stuttgart to make the seeds germinate. The external covering, as well as the nut, must be carefully opened, and the small seeds which are contained in the four cells of the nut taken out, and sown in pots, which are then placed in the bark bed, when the seeds will come up very soon.

30. *Descriptions of Two Sorts of Melons.* By M. Seitz.

One of these, *Cucumis serótina*, from Constantinople, is a winter melon; the second, *Cucumis Melo persicodorus*, from Rio de Janeiro, has a flavour which resembles that of a peach.

31. *On the Arrangement of a Public Garden for the Town of Magdeburg.* By M. Lenné.

M. Lenné presented to the Society plans and descriptions of this garden, which was begun under his direction: — 1. A finished vertical profile serving to show the ultimate effect. 2. A descriptive explanation of this profile. 3. A corresponding outline, or working plan for planting the trees. 4. Leveling plan of the ground (*Nivellemento Profile*). 5. A list of trees and shrubs, with numbers agreeing with those in the outline, to show the different kinds with which the groups and masses are planted.

The trees in the profile (*fig. 40.*) are beautifully disposed, and the bare inspection of the engraving is full of instruction to the young landscape-gardener. - We recommend him to study every part of it with great care, and more particularly the disposition of the masses relatively to the roads and walks, and of the scattered trees and small groups relatively



a, Road from Magdeburg to Schoenbeck.
b, Part of the fortifications of Magdeburg.
c, The river Elbe.



d, Public Assembly Room and Coffee-house.

e, Offices to ditto.

f, Temple commanding a remarkably fine prospect.

g, Public Hotel, with gardens and bowling-green attached.

to the masses. The natural surface not being much varied, the merits of the disposition of the trees may be, in a great measure, estimated without reference to the locality. The only references that will interest a stranger are given under the engraving.

On a future occasion we shall give the two working plans of the public garden of Magdeburg, with the list of the trees.

32. *On the Manner in which the Magdeburg Garden is laid out.*
By M. Linné, Garden Inspector at Sans Souci.

The ground intended for the garden originally contained only 57 acres, but was subsequently extended to 120 acres, which is not considered too large for a town like Magdeburg, containing 30,000 inhabitants. The highest spot on the ground is only 32 ft. above the usual level of the river Elbe; but as there is no higher ground in the neighbourhood of the garden, the views from this spot (where a temple (*f*) is placed) extend along the Elbe to a great distance. Certain parts of the town, not considered handsome, are concealed, and certain other parts are partially exhibited through a framework of trees. A bridge over the Elbe is made a conspicuous feature, as are the churches of certain neighbouring villages. The fortifications of the town are studiously concealed, by sinking the walks which approach nearest to them, and interposing trees, which being planted above the level of the walk, on artificial hills and banks, produce an immediate effect; the thickest plantations are made in places where protection is required from high north winds. A small stream is widened into a river, and varied by islands and groups; some of the groups near the river, and also in other parts of the grounds, are planted with shrubs which never rise above 6 or 7 ft. high, in order not to interrupt the continuity of particular views, and the effect of certain combinations. It is proposed to place in different parts of the garden monuments to the memory of great men. Some of the walks are narrow, shady, and solitary; others broad and open, for promenades; and others still broader for public drives. The cost of the whole, M. Linné says, will not exceed 18,000 dollars, (4000*l.*?) exclusive of the buildings. The rent that will be given for the public coffee-house (*d*) and its offices will more than pay for the annual keeping up of the garden. The total number of species of trees and shrubs planted in this garden is 192, and there are placed among them 193 varieties of fruit trees, which bear as standards. It is not stated whether one individual of each species and variety of tree is named; but we hope they are.

34. *Observations on the Culture of some ornamental Plants.* By M. Sinning, Botanic Gardener at Poppelsdorf, near Bonn.

M. Sinning plants *Brugmánsia suavèolens* in spring, in the open ground, on a south aspect, where the plants flower beautifully and abundantly. They are repotted again in autumn, and kept in a dry green-house during the winter. By this treatment a four years old plant produced 153 flowers in July, 79 flowers in August, and several more afterwards in the greenhouse. *Calàdium bicolor* is not taken out of the pot and kept dry, as is usually the practice, but is allowed to remain in the pot. When the plants are not in a growing state they are taken out of the bark bed, less water is given them, and they are always repotted after flowering. By this method a plant produced nine scapes, from 1 to 1½ ft. in height. *Calàdium vivíparum* also treated in this way grows very vigorously. — *Gloriosa supérba*. The bulbs are kept in the pots, on a shelf, in the back part of the stove, but not on the flue. Only a very little water is given them, to prevent the shrivelling of the bulbs. In the end of February or beginning of March they are carefully taken out and repotted in fresh mould, which consists of one part turf, two parts leaf mould, one part sand, and one part loam. The size of the pot should be such that there is only 1 in. between the side and the bulb, which should be covered an inch. After repotting they remain on the back shelf from four to six days, where the bulbs begin to swell; and after this they are placed in bottom heat, where they soon begin to grow very vigorously. They are allowed to remain there till the stems become too high for the pit, whence they are then taken into the bark bed of a stove. When they have obtained the height of from 2 to 3 ft., they must be again very carefully repotted, in the above-mentioned soil, with the addition of one part of well rotted cow dung. During their rapid growth they require an increased supply of water and syringing. By this method they will flower abundantly, not only on the main branches, but even on the weaker laterals. This culture is also applicable to all those *Scitamíneæ* whose stems die down during the winter.

35. *On different Species of Quercus.*

The following species of *Quercus* were recommended to be cultivated in consequence of the size and forms of their leaves :

Q. álba velutína, acerifòlia? aquática, Castànea, falcàta, imbricària, macrocárpa, nìgra, palústris, rubra, tinctòria, and

triloba; for useful timber, *Q. Prinos monticola* and *Q. Prinos pennsylvanica*; and for colour, *Q. álba* and *tinctòria*, and *Phéllus angustifólius*.

39. *On the Germination of Seeds.*

M. Otto states that he uses oxalic acid to make old seeds germinate. The seeds are put into a bottle filled with oxalic acid, and remain there till the germination is observable, which generally takes place in from twenty-four to forty-eight hours, when the seeds are taken out, and sown in the usual manner. Another way is to wet a woollen cloth with oxalic acid, on which the seeds are put, and it is then folded up and kept in a stove; by this method small and hard seeds will germinate equally as well as in the bottle. Also very small seeds are sown in pots, and placed in a hot-bed; and oxalic acid, much diluted, is applied twice or thrice a day till they begin to grow. Particular care must be taken to remove the seeds out of the acid as soon as the least vegetation is observable.

M. Otto found that by this means seeds which were from 20 to 40 years old grew, while the same sort sown in the usual manner did not grow at all.

42. *Account of the Experiments made in the Veterinary College at Berlin, for ascertaining what sort of Wood will remain longest in the Ground without rotting.* By M. Hartwig.

Stakes of firs, oaks, and of *Robínia Pseud-Acàcia* were, after being five years in the ground, not the least altered; while, after two years, almost all others, as *Tília* (lime wood), *Bétula álba* (white birch), *Cárpinus* (hornbeam), *Acer* (maple), &c., were more or less rotten. *Sàlix*, *Júglans*, *Fágu*, *Castànea*, and *Plátanus*, lasted four years. He also observed that those stakes which had their bark left on, or were, as usual, oiled or tarred, did not keep any longer than those without either bark or preparation; but that those which were burned a little way above and below the ground stood well, particularly when tarred. This being the cheapest method, it will be more in use than the following, which, however, is the best way for preserving wood. It must first be painted with oil colour, and, after it is dry, a sheet of iron, about 16 in. long, must be put round it, so as to be as much in the ground as above it, and then the whole should be painted again.

Stakes or posts treated in this manner will remain perfectly sound for a long time.

48. *On the Culture of Nelúmbium speciòsum.* By M. Lübeck, Director of the Gardens of Comte Karrach, at Bruck on the Leitha.

After the points of the seeds are carefully opened, they are put into a glass of water, where they soon germinate; they should then be planted in pots, half-filled with loamy soil (taken from places where *Nymphæa álba*, &c., grow), and filled up with water. This being done in spring, the plants will be very strong-grown against the winter, when no water should be allowed to remain in the pot, but only given from time to time. When they begin again to grow, in the following spring, they are to be shifted into other pots, and treated as in the former year. In the third year they will require a large jar of about 2 ft. high, and 1½ ft. wide. The water must be occasionally changed, but without disturbing the plant, which is easily effected by a tap in the jar. The plants will then grow very vigorously, and flower beautifully. A plant treated in this manner produced a scape 6 ft. high, and also ripe seeds. M. Lübeck recommends this plant, and its varieties, as an ornament in a water basin in conservatories; which basin should, however, not be square, but circular, to allow the roots to run freely round it, which the strongest roots of this plant always do.

49. *On Cleft-Grafting the Vine.* By M. Linné.

This has been practised with perfect success at the royal gardens at Potsdam. The grafting is done as near the ground as possible, and grafts are chosen to be equal in diameter to the stock, so that both sides of the bark of the graft and of that of the stock may fit exactly together. After being tied, the soil must be raised to cover the graft, and when the stock is too high this may easily be accomplished by a flower-pot filled with earth. By this way of engrafting, grapes were obtained the first year as large and plentiful as on any other vines.

54. *Extract from the Transactions of the Society at the Meeting of October 10. 1824.*

The gardens in Riga, M. Zigra stated, are chiefly laid out in the English and Dutch styles, and consist principally of fruit and kitchen gardens. In several private gardens are large glass-houses, in which pines, peaches, and grapes are grown plentifully. The extensive forcing-houses of the Russians supply abundance of asparagus, melons, cucumbers, and other vegetables, very cheap, and at a season when they

can hardly be seen in other parts of the country. — M. Fintelman exhibited fruit from sweet chestnut trees, which had been grafted on oaks [both belong to the same order, Cupuliferæ], and a plant of *Chionanthus virginica* grafted on *Fraxinus excelsior* [both *Olëinæ*]. It was also mentioned that at Schumegh, in Hungary, a *Rosa semperflorens* produced 1680 blossoms in the year 1820, 2765 in 1821, and 2183 in 1823.

59. *On the Flowering of Vines.* By M. Keller, at Freiburg in Breisgau.

It is often observed in vineyards that healthy plants, even in favourable seasons, never produce any fruit. This is sometimes occasioned by the plants producing only male flowers; and in these cases the anthers are sessile, or, if the filaments are present, the anthers are wanting. A second cause of this failure is when only female organs are developed, which, however, are sometimes impregnated by insects with the pollen of other plants, and therefore produce berries only very sparingly. A third and very prevalent cause is, when the calyx opens on the top, and forms a basin, which retains water about the organs of impregnation, and thereby hinders them from performing their respective functions; although plants of the above description grow very vigorously and healthily, in consequence of their not producing any fruits, they should be either destroyed, or reingrafted from a plant that flowers perfectly.

The above comprise all that is interesting to the British gardener, in Vol. II. of these *Transactions*, with the exception of a plan for laying out a *ferme ornée*, by M. Linné, and the working plans of the public garden at Magdeburg, which we shall give on some future occasion.

We have just received the second part of the seventh volume of this work.

ART. IV. *Catalogue of Works on Gardening, Agriculture, Botany, Rural Architecture, &c., published since January 1831, with some Account of those considered the most interesting.*

The Quarterly Journal of Education. In Quarterly Numbers, 8vo. Commenced Jan. 1. 1831. Knight. Numbers I. to IV. 5s. each.

We have been disappointed in this publication. Education is, no doubt, a word that includes a great deal; and for this reason, we suppose, the editor of the work before us feels justified in reviewing such books as Plutarch's *Lives*, *A Description of Rome*, Conder's *Italy*, Williams on *The*

Geography of Ancient Asia, Herodotus, Lemprière's Dictionary, &c. We should have thought that the straightforward way of improving the school education of the country would be to examine the merits and defects of all the different systems employed, comparing them with those of all other countries, and suggesting improvements. All this might have been done in a monthly sixpenny pamphlet, which would probably have circulated as extensively as *The Library of Entertaining Knowledge*, and might have done as much good as that deservedly popular work. But even as a quarterly review of books on education, this journal is deficient, inasmuch as, while it has gone out of the way in search of books of travels, descriptive works, and dictionaries, it has neglected almost all the works which treat on education specifically; such, for example, as Ensor's *National Education*, Lasteyrie's works, and a great many others in the English, French, and German languages. It was not till the fourth number of this journal appeared, that any account was given of the New England free schools, and of their effect on the population of that portion of the United States (see Vol. VII. p. 644. note.). But we cannot occupy more room with the subject; and conclude by observing, that, highly laudable as are the objects of the Society for the Diffusion of Useful Knowledge, their method of endeavouring to attain them is singularly defective and oblique. There is evidently a want of moral courage.

Moggridge, John II., Esq.: Popular Education in France, its present State and future Prospects; with Suggestions for its Improvement and Extension in Great Britain and Ireland. Pamphlet, small 8vo. London, Longman, 1831. 1s.

This is an important little tract, by our enlightened and liberal-minded correspondent, Mr. Moggridge. We could wish it were in the hands of every man who has any political influence, however small; for sure we are that there never was a time when the necessity and advantages of educating the great mass of society were so great and obvious as at present. Surely it is impossible that we should long continue to neglect what has been so earnestly set about by a neighbouring people. For what they have done, let the reader look at the following extract from the analysis of Mr. Moggridge's pamphlet:—

“Education in France, neglected before 1789.—Law for the establishment of Primary and Central Schools—perverted by Bonaparte—frowned on by the Bourbons. Schools of mutual instruction supported by individuals—opposed by those of ‘the Missions.’—Infant schools intended to form part of the National System.—Education begins at the birth—necessity for early attention, supported by Bacon, Locke, Dugald Stewart—able article thereon in the supplement to *Encyclopædia Britannica*—a necessary part of good government—best prevention of scenes of bloodshed and disorder.—Education not confined to schools—happiness the object and end of education—good and bad education—exemplified in Ireland.—Misgovernment carries with it the seeds of its own dissolution—when that arrives, the peace of the country, and safety of persons and property, depend on the prevalence of education.—Population of Paris in 1792 prepared for being converted into savages—the people of that city in 1830 merciful and generous, amidst the greatest provocation—why?—‘marked feature of the Revolution’—character and happiness of the people, and the peace, welfare, and stability of society, dependent upon sound, liberal and extended education.—Education coexistent with life itself.”

Anon.: Sussex Association, for improving the Condition of the Labouring Classes. 12mo, London. No. I. To be continued occasionally.

Anon.: Quarterly Report of the Sussex Association for improving the Condition of the Labouring Classes. 8vo. London, 1831. No. I,

We feel great satisfaction in giving publicity to the benevolent efforts of this Association; for though we look upon these efforts merely as palliatives, till some radical measures of improvement shall be adopted by government, we still think they will do good. We wish we could see, in addition to the reserve of labour, which it is the object of this Society to procure for every man in his own garden, a national reserve, in the improvement of the public roads and rivers, and a national system of education, high, equal, and universal. Mankind will never have a fair chance till they are placed upon a perfect level in respect to useful education, agreeable manners, and civil rights. When this shall be the case, every part of society will be able to take care of itself, without depending on the patronage of any other part; and services and goods will be exchanged with as little sense of obligation on either side as men now give shillings for sixpences.

At a meeting held on the 17th of March, 1831, at the house of J. Smith, Esq. M.P. Grosvenor Square, Westminster, to consider of the expediency of forming an association for improving the condition of the labouring classes in the county of Sussex; John Smith, Esq. M.P., in the chair; the following resolution, among others, was unanimously agreed to:—

“Resolved, That we now present do form ourselves into a Society, to be called the Sussex Association, for improving the Condition of the Labouring Classes, and that the following declaration be adopted as the general outline of its objects:—The proposers of the Association have observed with regret, that the state of the agricultural labourer in Sussex and the adjoining counties has of late years been gradually deteriorating; the extraordinary political circumstances of the country having induced a very general misapplication of the poor's rate, and the adoption of a rate of wages inadequate to the due encouragement of provident industry, and too often to the necessities of life. The peasant being unskilled in any mechanic art, has only his labour to sell, and is compelled to take market price for it. If one labourer will not work for what is offered, another will; and the consequent depression of wages is a proof that there is too much of the article labour in the market. The obvious remedy for this is, to enable the peasant to sell, at least, a portion of his labour to himself; and this may easily be effected by procuring for him, at a fair rent, as much land as may employ that portion of his labour for which he cannot obtain from the farmer a remunerating price. This all-important remedy for the miseries now endured is easily applicable in every place by the proprietors of land. The experiments which have been carried on for some years past on the Gravely estate, at Lindfield, near Cuckfield in Sussex, prove, that by allowing an acre of land to the labourer, at a fair rent, and making him cultivate one half of it in potatoes, and the other half in corn, proper attention being paid to the preservation and application of manure, he will be enabled, while earning fair wages from the farmer, to support his family in comfort and independence, and to avoid the degrading necessity of being a burthen to the parish. Deeply impressed with the value of the labouring class to the community at large, and fully aware of the strong claim that it has to the sympathy and protection of the classes above it, and with the necessity that exists for enquiring, more minutely than has yet been done, into the nature of the privations and sufferings of the peasant, with a view to propose measures for his relief by all lawful and practical means, we have formed the Association for the accomplishment of the following object:—We will endeavour to obtain correct information relative to the circumstances of the agricultural and other labourers in the different parts of the county of Sussex, also details of all measures and plans which may have proved suc-

cessful in bettering his condition in any part of the kingdom. We will, from time to time, give publicity to the information thus obtained, by printed reports, as often as a sufficient quantity of interesting matter shall have been received. An agent or secretary shall be hired, at a suitable salary, to be employed under the direction of a committee, to obtain information, and give advice and assistance, in different parts of the county, and to promote every where the allotment of land to the labourer, and to suggest such improvements in the construction and economy of cottages as may conduce to the comfort and advantage of the cottager. The Society shall endeavour to obtain the cooperation of as many gentlemen of experience and influence in the county as possible, and will establish a correspondence in the different towns and villages. A subscription shall be immediately raised to defray the expenses of the agent's salary and travelling expenses, and the printing of the Society's reports. The Society shall consist of subscribers of 1*l.* per annum and upwards. The business of the Society shall be conducted by the committee; three of whom shall form a quorum for the transaction of business, and they shall have power to add to their number in the intervals between the general meetings. The sittings of the committee shall be held at such times and places as may hereafter be agreed upon. A meeting of the members shall be annually held, at which a report shall be read of the state of the funds and the progress of the Society for the last year. At this meeting the committee and officers shall be appointed for the ensuing year."

The second publication, of which we have given the title, seems to be a repetition of the former, with additions, chiefly by Mr. Allen. The most important fact which we find among these additions is, that at Lindfield, Sussex, a cottage with three sleeping-rooms, a sitting-room, a pantry, a privy, and a pigsty, may be built with substantial clay walls, and covered with thatch, with suitable drains, stoves, sink, and manure pits, for 70*l.* Edward Constable, builder, of Lindfield, will engage to build by contract any number of cottages of the same description at the above price. The benevolent author thus concludes:—"If, as I have shown, a good and sufficient cottage can be built for 70*l.*, and that standing on an acre and a quarter of ground, it might be let for 2*s.* 6*d.* per week, or 6*l.* 10*s.* per annum, who that has land, and the means, would hesitate to provide for the happiness of his labourer? Do not the facts which I have brought forward prove to demonstration, that landowners have it in their power to diminish most materially that mass of misery under which many parts of the country now groan? Let us then perseveringly employ all the influence we may possess, to endeavour to prevail upon the public-spirited among them to adopt measures in which they, as well as the poor, are deeply interested. Let them see that every cottage has a sufficient number of sleeping-rooms, three at least; and above all, that it has an acre and a quarter of land attached to it. Let them see in their respective parishes that *work*, and not *money*, be given to able-bodied labourers who may apply for relief; that the rate-payers be furnished from time to time with a printed account of the sums received from the rates, and the names of all the parties upon whom the money is expended, together with the amount paid for each; let them, to the utmost of their power, discourage and put down every thing which tends to the demoralisation of the poorer classes. In proportion as these patriotic and Christian exertions are multiplied, in that proportion will the strength and happiness of our country be increased. We do not so much want legislative enactments, as a union among the rich and powerful in the promotion of the objects now stated." (p. 33.)

Several quotations are made from Denson's *Peasant's Voice*; and we agree with Mr. Allen in strongly recommending that work to every person interested in bettering the condition of the agricultural labourer.

Anon.: An Address to the Labouring Classes; being intended to explain some of their Duties as Members of the Community. Pamph. 8vo. Edinburgh, 1831.

The advice here given is grounded on the principle of self-preservation; the only true principle, in our opinion, as applicable to any class of society. Cheap newspapers, in which the fundamental principles of morals and politics are sparingly introduced among ordinary news and other topics, in order that the former may be slowly but surely imbibed, are recommended for the adult population, and a high degree of school education for their offspring. The evil effects of early marriages are noticed, in producing an excessive competition for labour, and consequently a fall of wages. In his remarks on the choice of a wife, he observes:—"It is not only the qualities of the body which are transmitted, the qualities of the mind are so also. We see an honest, economical, prudent couple have honest economical, and prudent children." Cleanliness, ventilation, and benefit societies are recommended; and the whole of the pamphlet breathes an excellent feeling of benevolence and sound practical sense. It forms a very fit companion for the *Scotsman's Advice to the Labouring Classes*, published about two years ago; and from which we have quoted largely, in the section on the "Conduct and Economy of an Agriculturist's Life," in our *Encyclopædia of Agriculture*.

Anon.: Facts and Illustrations demonstrating the important Benefits derived by Labourers from possessing small Portions of Land. Monthly Numbers. London, Dean and Munday, 1831. Nos. I. to X. 3d. each.

The Society issuing this work has already been noticed (Vol. VII. p. 224.); it seems to be patronised by the king, queen, and a number of the nobility; and these cheap tracts will, we trust, do much good. The great and ultimate object of all such societies ought to be, to enable the labouring classes to take care of themselves; and for this purpose a national reserve of labour at a minimum price for the grown up poor, and useful education for their children, are the requisites. How easy for the government to effect both in one session of parliament! We have elsewhere shown (*Morn. Chron.* Dec. 31. 1831) how much the territory of Great Britain would be improved by the application of the reserve labour.

Anon.: Time's Telescope for 1832; or a complete Guide to the Almanack; containing an Explanation of Saints' Days and Holidays, with existing and obsolete Rites and Customs, Sketches of contemporary Biography, &c. &c. Astronomical Occurrences for every Month; comprising Remarks on the Phenomena of the Celestial Bodies. Notes of a Naturalist, explaining various Appearances in the Animal and Vegetable Kingdom, &c. 8vo, nearly 400 pages, and numerous Engravings. London, Sherwood and Co. 1832. 9s.

Of the three divisions of this book, the first and last are likely to be most popularly pleasing: the last, or Notes of a Naturalist, is by Professor Rennie, and is in great part a compilation, divided into 12 monthly chapters. The middle part, on astronomical phenomena, may delight the scientific, but seems too abstruse for the mass of readers.

Anon.: Arcana of Science and Art; or an Annual Register of Useful Inventions and Improvements; abridged from the Transactions of Public Societies, and from the Scientific Journals, British and Foreign, of the Past Year. With several Engravings. Fifth Year, 1832. Small 8vo, pp. 300. London, Limbird. 5s.

Any young gardener, who, besides prosecuting his particular profession, wishes to be apprised of what is passing in the great world of human action generally, cannot possibly spend 5s. more efficiently than in the purchase of this book. Its title, attentively perused, will show him this.

He would even do well to apply the first spare sovereign he may wish to spend to the acquisition of the four back volumes, and then, subsequently, continue the work annually. In the present volume there are upwards of 100 pages on natural history, and 30 besides on rural economy and gardening. — *J. D.*

Bryan, James Butler, Esq., A Barrister in Dublin, and a landed Proprietor: A Practical View of Ireland, &c. 12mo. Dublin, 1832.

This is a work of immense labour, and of sound practical views, well deserving the attention of the legislature, and of all who take an interest in Ireland. The author recommends the establishment of poor laws, and of grand juries for the purpose of creating employment on public works, to be paid out of county rates. If these are not granted, he says, there will be a demand for the repeal of the Union from one end of Ireland to the other. Mr. Bryan is also a powerful advocate for a National System of Education, neutral with respect to religion, and consequently open to all sects and parties. This we consider the only mode which can strike at the root of all the evils which now affect the labouring classes in England, as well as Ireland, by enabling the next generation to take care of themselves. The palliative for the evils which affect the present race is employment; and this Mr. Bryan provides for in Ireland by his grand juries, as we would in England by our National Road System. (See p. 97. and *Morn. Chron.* Dec. 31. 1831.)

Braidwood, James, Master of Fire Engines in Edinburgh: On the Construction of Fire Engines and Apparatus, the training of Firemen, and the method of proceeding in Cases of Fire. 8vo. Edinburgh, Bell and Bradfute, 1830.

The firemen of Edinburgh are allowed to be the most efficient corps of the kind in Britain, perhaps in Europe; and this is the first and only work on fire engines and firemen in the English language. It deserves the attention of all insurance companies and the heads of municipal police throughout the world. Being only indirectly connected with our subject, we cannot spare room for details.

Don, George, F.L.S.: A General System of Gardening and Botany; containing a complete Enumeration and Description of all Plants hitherto known; with their Generic and Specific Characters, Places of Growth, Time of Flowering, Mode of Culture, and their Uses in Medicine and Domestic Economy. Preceded by Introductions to the Linnæan and Natural Systems, and a Glossary of the Terms used. Founded upon Miller's Gardener's Dictionary, and arranged according to the Natural System. In 4 vols. 4to. London, 1830. Vol. I. pp. 840, with numerous wood-cuts, 3*l.* 12*s.*; or in Monthly Parts, 6*s.* each.

A book that has been long wanted, will be hailed with joy by numbers, and will create a host of botanists in Britain. Of those who admire plants, and who does not? numerous are they who have hitherto been prevented acquainting themselves botanically with plants, both by reason of the multitude of books in which the required information existed, and of the unintelligible language in which these books are written. These inconveniences are, by the book before us, now abolished. The amount of information on technical and systematic botany previously existing in numerous books, in various languages, is here concentrated and exhibited in familiar English. We hail the book, therefore, as a valuable instrument for promoting the extension of botany, and the rapid and essential improvement of all those already possessing some rays of botanic knowledge. It will be even valuable to proficients, for we are told that it comprehends, "besides all the genera and species which have been published up to the present time, descriptions of numerous plants never before published, and derived chiefly

from the *Lambertian Herbarium*," and that "the characters of all the genera and species are derived either from the plants themselves, or from the original authorities where authentic specimens could not be procured." The scope and object of the book are, as its title declares, to enable us to acquaint ourselves with the names of plants, their uses in medicine and in domestic economy, and with the best modes of cultivating them. These are delightful objects, and only inferior to the volumes of sentimental associations which plants are ever suggesting. They address, and irresistibly address, every passion and capacity of our souls. If, however, these latter considerations are by some more esteemed than the detailed technicalities, and even beyond the systematic combination of those technicalities, it is right to assume and assert that the former will be most sensitively felt, and their force and power most fully appreciated, by those best versed in the latter, which are the objects the book includes. Our inference is, then, that to all who love plants, whatever be the grounds of their affection for them, the book is valuable and indispensable.

The book must and will be widely spread, and deserves to be, on every account but one; this is, its price. We think the publishers have erred in naming it "A General System of Gardening;" this it is not, but rather a directory on vegetable culture. We feel constrained also to remark that the editor might, after *London's Hortus Britannicus* had passed through his hands, have introduced, both profitably to himself and readers, the more discriminative signs and characters of that work, or others equivalent to them: these would have concisely expressed several minor points, which now, for the sake of avoiding circumlocution, are here and there left undetermined. — *J. D.*

Hooker, J. W., LL.D. F.R.A. and L.S., and Regius Professor of Botany in the University of Glasgow: The Botanical Miscellany; containing Figures and Descriptions of such Plants as recommend themselves by their Novelty, Rarity, or History, or by the Uses to which they are applied in the Arts, in Medicine, and in Domestic Economy; together with occasional Botanical Notices and Information. Illustrated by numerous Engravings. London, Murray. In Quarterly 8vo Parts, 10s. 6d. each.

Parts v. and vi. are each accompanied by ten coloured plates in quarto additional to the usual supply of octavo plates in Part v. These twenty coloured quarto plates are by Richard Wight, M.D., and are illustrative of articles by him, in the Miscellany, on the botany of India, principally of that of the southern parts of the peninsula. The quarto form was chosen for these exquisite plates, in order to do the plants figured more perfect justice, but the quarto form proving objectionable, Part vi. informs us that "in future the plates illustrative of Indian botany will be published in a form so as to bind up with the volume, instead of forming a separate one of a larger size."

We cannot now give any analysis of the contents of the late numbers of the *Botanical Miscellany*, but venture to assert that it maintains the character of originality which characterised the first number; and that in consequence of the new and important information it imparts; the good supply of letter-press, each part averaging more than 200 pages; and the liberal supply of plates, mostly uncoloured it is true, but drawn and engraved in a style of superior excellence; the work is, notwithstanding its price, half a guinea, really a cheap one. — *J. D.*

Sinclair, Sir John: Hints on Vegetation, the Agents necessary for the Production of Plants, and those which are injurious or destructive to them.

This little pamphlet is a remarkable one, not so much for the information it communicates, as for the republican manner and feeling in which

it asks information from every body who is conversant with the subjects expressed in its title. It states, in a brief and explicit manner, the amount of what has been hitherto ascertained on the relative and comparative agency of earth, air, water, light and heat, manures, and cultivation, in influencing vegetation: we perceive nothing new in what is stated. Of the agents destructive to vegetation, "minerals or noxious substances in the soil" and "vermin" only are enumerated. Then follow hints on "raising new varieties of plants and vegetables," the amount of which is hybridising, a mode now as familiar to the majority of gardeners as the alphabet. To these succeed "hints on the culture of potatoes." To all these succeeds an appendix, containing "queries, addressed to farmers, gardeners, and nurserymen." There are 22 queries concerning the influence of the earth on vegetation; 15 queries on the influence of air; 10 concerning water; 18 concerning light and heat; 12 concerning manures, or dead organised matter; 9 concerning culture; 8 concerning substances in the earth injurious to vegetation; 12 concerning vermin noxious to vegetation; 14 concerning the improvement of plants, by the introduction of new varieties, or crossing different species of the same kind of tree or plant; and these last queries, it is remarked, are peculiarly recommended to the reader's attention. It is added:—"Any other facts on the subject of vegetation, not included in these questions, will be extremely acceptable. Answers are requested to be transmitted to Sir John Sinclair, Bart., 133. George Street, Edinburgh; T. A. Knight, Esq.; or P. Neill, Esq., Edinburgh." This remark is appended to the queries:—"It is quite unnecessary to go through the whole of these queries, but only to refer to those points with which the writer by whom any answer is sent happens to be peculiarly conversant." This is the most comprehensive scheme we have ever seen for amassing a vast stock of particular facts, out of which to elicit, by cautious induction, safe conclusion. We wish the queries, which seem clearly enounced, may be copiously answered. — *J. D.*

Memoirs of the Caledonian Horticultural Society. 8vo. Edinburgh, Maclachlan and Stewart, 1832. Part I. Vol. V. 3s.

This Part of 128 pages of large type, rather loosely printed, contains six articles by as many practical gardeners, and five by amateurs. From a hasty glance at these papers, there does not appear much in them that we have not already laid before our readers, in this Magazine, or in the *Encyclopædia of Gardening*; but we shall examine it with care, and in due time give the essence.

Leigh, Peter, Esq. M.A.: The Music of the Eye; or, Essays on the Principles of the Beauty and Perfection of Architecture, as founded on and deduced from Reason and Analogy, and adapted to what may be traced of the Ancient Theories of Taste in the three first chapters of Vitruvius; written with a view to restore Architecture to the Dignity it had in Ancient Greece. Royal 8vo, 42 plates. London, Walker, 1831. 11. 10s.

The author's chief reason for calling architecture the music of the eye is, that certain Greek lexicographers considered the words *music* and *art* as synonymous. "It is the object of these essays to investigate the principles of architectural beauty, and to form them into a system." At the same time, the author is "not so confident as to anticipate, nor so vain as to imagine," that his work is any more than "an outline, to be completed by the finger of time and experience." He claims, however, "some title to originality and system," and considers it wrong "to conceal these attempts from the public, though they should be pursued by all the virulence which sometimes accompanies modern criticisms."

Our criticism shall not be virulent; though we are bound to say, that, after having perused the work with attention, we have risen from it convinced that the author is altogether unfit for the task which he has undertaken. There is no evidence that the author understood his subject; if he had, he would have adopted a clear and obvious arrangement, instead of a series of unconnected essays, in each of which the style is most desultory and obscure. His great stumbling-block is Vitruvius. If, instead of seeking for the principles of architecture in this author, he had had recourse to the common principles of human nature, he would have arrived at far more satisfactory conclusions than those which follow; and, in order that we may not misrepresent him, we shall give them, as nearly as possible, in his own words, from his ninth and concluding essay:—

“All architecture must be divided into foundations, supports, and shelter.”

“Architecture is divided into styles or schemes, depending on different modes of distributing forms, and applying them to different uses. These different styles or schemes are the following:—”

“1st, The Arrectarial (*arrectaria*, upright supports in buildings), which embraces the most beautiful specimens of Greece. 2dly, The Fulcimental (*fulcimen*, a prop) or buttress style, which is divided into the heads of flying, finial, and intermediate buttress. 3dly, The Archi-columnal, composed of arches and columns, divided into two kinds, one with a trabeation (*trabs*, a beam) between the arch and the column, and the other without. 4thly, The Monotrabeal (*monos*, one, *trabs*, beam), which is the simplest scheme, and of which there might exist numberless varieties. 5thly, the Pariefenestral (*paries*, a wall, *fenestra*, a window), which is as multifarious almost as the combination of forms themselves, of which we have ample proof in the variety of Gothic specimens alone. And, 6thly and lastly, the Sectional scheme, which has the faculty of being as multifarious as the last.”

Taxis embraces the consideration of the finishing touches of the design. “Ornament may be comprised under the heads formal, diffused, simple, and mixed, in which it is desirable to aim at utility as much as in the bolder features of the design. The brightest perfections in taxis are distinctness, efficiency, and relationship, which should pervade the design.”

“The 5th essay enters upon the subject of proportion. Without recapitulating what others have said on this subject, it is only necessary to enforce the importance of Vitruvius’s division into eurhythm and symmetry: unless we have a clear idea of this, it is utterly impossible that any good effect can be produced. We know that eurhythm respects the proportion of one whole, whether that whole be the whole building, or any whole member of which that building is composed; the symmetry is the relative proportion of two or more such wholes.”

“The disposition of form in a style according to the principles of contrast and relief, which in the Athenian period may have borne the name of diathesis, forms the subject of the sixth essay. The contrast and relief which is to be aimed at in diathesis will be exhibited in the position, form, proportion, and projection; and as form is divided into the heads of simple and ornamental, and proportion into eurhythm and symmetry, we get other divisions of diathesis under those heads. The contrast of position has least existence in architecture, though it occurs repeatedly in ornament. What is most to be noticed in the diathesis of form and proportion is, that as they are often very much blended together, it is desirable to get a distinct idea of their separate existence, in order to use them with more force; the diathesis of projecture belongs to parts only displaying shelter.”

The greater part of the work is written in the above style. The plates

are outlines from copper, and would have been much more convenient if given as woodcuts along with the text. The book might then have been sold at a third of its present price.

As we are desirous of introducing all the best works on rural architecture to our readers, with a view of improving their taste, so we have considered it right to guard them against a work which, in our opinion, only mystifies the subject on which it professes to treat.

Anon. [presumed to be by Mr. Sinclair, of the New Cross Nursery, F.L.S. and H.S., Author of *Hortus Gramineus Woburnensis*, &c. &c.]: Four Numbers on the Planting of Forest Trees, forming Nos. 19, 20, 22, and 23. of the Farmer's Series of the Library of Useful Knowledge. 8vo. London, Baldwin and Cradock. Nos. 19, 20, 22. 1831; No. 23. 1832. 6d. each.

A glance through these numbers has enabled us to aver confidently that they form an important present to every one possessing predilections for planting. "Present," we have said, and this is proper; for, thanks to the Society for the Diffusion of Useful Knowledge, so valuable a body of information on planting has never before been attainable for the inconsiderable sum of two shillings.

The writer divides planting into forest-tree planting, ornamental or garden planting, and orchard or fruit-tree planting. The four numbers here noticed only relate to the planting of forest trees; the other two divisions will be treated of in numbers to be subsequently published. Forest tree planting is treated of in eight chapters. The first exhibits the personal and national advantages resulting from judicious planting; and this subject is incidentally resumed in the beginning of the fourth chapter, where are some such striking remarks on, and selected proofs of, the profitable application of human labour to soils far from the best for purposes of planting, as will lead the political reader to exclaim, Heavens! why are our poor suffering for want of employment and comforts? The second chapter is on physiology, the third on the modes of propagation, the fourth on the fittest soils and sites, the fifth on the preparation of soils, the sixth on the culture and management of plantations, the seventh on the statics of the products of plantations, and the eighth and last consists of "an enumeration of the different species of forest trees, as well those of large growth, as those of under-growth for coppice wood, ornament, or shelter. Their generic botanical characters, their natural soils, mode of propagation, and the uses to which their timber is more generally applied."

This last chapter, which occupies four pages of No. 22. and the whole of No. 23. is, in our estimation, the more popularly useful one, because it places before the planter desirous of variety, rich lists of hardy trees and shrubs eligible for his purpose, of which he has hitherto, through ignorance of their existence, their characters and attributes, been unable to avail himself. This part of the Treatise on Planting becomes, in consequence, what has long been wanted, a means of informing those not already familiarised with the contents of our British nurseries, of what numerous appropriate species and varieties of hardy trees and shrubs await them, as the progress of planting shall arouse them to procure and apply them.

Notwithstanding our preference of this part of the treatise, as being the more popularly tangible portion of the work, it is but justice to assert that the seven preceding chapters are rich in information on their respective subjects. The positions advanced and facts supplied seem to have been well considered and appropriately disposed. We commit, however, nearly all these to the attentive perusal of some able correspondents, severally versed in the respective branches of the subject, and who may feel disposed,

through our pages, to give the writer and the public the benefit of their animadversions, be they commendatory or critical.

The writer's remarks on soil are admirable, as teaching persons concerned in planting the necessity of greater definiteness in their frequent mentions of soil. He distinguishes "heath soil," p. 48., and "peat soil," p. 51.; and exhibits the constituent ingredients of each, as learned from chemical analysis. He discusses ten prevalent kinds of soil in the same manner; but we notice the above two kinds for the sake of remarking, that what he has done in a scientific manner, we had had the pleasure to do a few weeks before the appearance of his book, in an empirical one: see the remarks "On Heath mould and Peat," Vol. VII. p. 285.

At p. 71. a list of the insects which are most injurious to forest trees is given. Among these, *Scólytus destrúctor* occurs, and in the remarks subjoined to this list is denominated "a formidable insect." The writer deems this pretty little animal guilty of the murder of healthy living trees, and decries it accordingly; but remarks, "It has been supposed to be the effect of the disease, rather than the cause of it." In viewing the historical circumstances appertaining to the *Scólytus destrúctor*, the writer refers to the well known case of the trees in Camberwell Grove, all the circumstances relative to which will be found detailed in Vol. I. p. 378., and some annotations on those details are presented p. 383., which go to "suppose" the *Scólytus destrúctor* the "effect rather than the cause" of the death of these trees. Since that period, a writer in the *Magazine of Natural History* (Vol. IV. p. 152—156., published March, 1831) stoutly contends, and exhibits arguments derived from experiment and patient research to prove, that "the *Scólytus destrúctor* is altogether guiltless of causing the death of healthy growing trees." Which of the two opinions is the true one, future observation must determine.

The kind of tree, whether living or dying, in which *Scólytus destrúctor* is most usually found, is elm; but in the Treatise on Planting before us, p. 73., is this remark:—"The pine is liable to be injured by the insect before mentioned, in the same manner as the elm." Is not this a mistake? Are not the erosions in pine bark effected by *Hylúrgus pinipérda*? and are not this insect and the *Scólytus destrúctor* essentially distinct? Of the *Hylúrgus pinipérda* under the name of *Bóstrichus pinipérda*, see a figure and a short notice in Vol. II. p. 355.—*J. D.*

Horton, Richard, Land Steward and Surveyor: Tables for planting and valuing Underwood and Woodland; also Lineal, Superficial, Cubical, Wages, Marketing, and Decimal Tables: together with Tables for converting Land Measure from one denomination into another, and Instructions for measuring Round Timber. Small 8vo. Saffron Walden, and Longman and Co., London, 1832. 6s. 6d.

A most useful work for bailiffs, foresters, stewards, &c.

A Woodman of Arden [a Warwickshire Clergyman, we believe]: The Midland Forester. 12mo. Birmingham, Wrightson, 1829. 6d.

Concise, judicious, and practical. The author wisely answers the question, Which is the most profitable employment for capital, planting for timber, for shelter, or for ornament? by recommending ornamental planting as the most profitable for a populous and increasing neighbourhood. "It often adds, in a very few years, cent per cent to the value of an estate." (p. 51.)

Henslow, Rev. J. S., M.A., Professor of Botany in the University of Cambridge: On the Examination of a Hybrid *Digitalis*. A quarto pamphlet, being a detached copy of the article published in the *Trans-*

actions of the Cambridge Philosophical Society. The pamphlet has no publisher's name affixed to it, and is probably not for sale.

Hybridising is the art of imbuing the ovules of one plant with the additional or distinct properties of some other plant. From *Digitalis lutea* impregnated by *D. purpurea*, Professor Henslow obtained a decided hybrid, "obviously having most of its characters exactly intermediate between those of *purpurea* and those of *lutea*." This is the fact which forms the theme of the professor's most able pamphlet; for although in the fact itself there is nothing surprising, now that hybrids in various genera are familiar to all gardeners, the inferences the professor draws from this fact, and the modifications in structure which he shows the hybrid to have undergone in almost every one of its parts, render the pamphlet a most important contribution to physiological botany. We hope our gardening friends will be stimulated by the following polite reproof so to change the state of things as never to merit a second such. "Although," the professor remarks, "the propagation of hybrid plants has been much attended to of late years by several horticulturists in England, their experiments for the most part seem to have been undertaken for the sole object of increasing the forms of beautiful flowers, or of modifying the flavours of delicious fruits. But the more curious and important physiological facts, elicited by the phenomenon of hybrid productions, do not appear to have received a proportionate degree of attention from those who have been engaged in these experiments."

"Chance having favoured me with a hybrid *Digitalis* during the summer of 1831, in my own garden, I employed myself, whilst it continued to flower, which was from June 19. to July 22. in daily examining its characters, and anatomising its parts of fructification. I was careful to compare my observations, with as much patience and accuracy as I can command, with the structure of its two parents. It seemed to me not unlikely that something interesting might result from a rigorous examination of this kind, or at least that its recorded details might serve as a point of departure for future observations."

Something indeed interesting has resulted; a stock of facts of the highest importance to physiologists has been elicited; and the details have been elaborated, described in words, and illustrated by engravings, to an extent marvellous for the patience and the industry they must have demanded. This will be clear to our readers when we remark that the detailed descriptions of, and observations on, the various parts of the plants, not omitting the most minute parts which very high magnifying powers could elucidate, occupy twenty quarto pages; and the various figures of parts, some whole, some dissected, some of the natural size, but the majority highly and some very highly magnified, occupy three quarto plates; and there is, besides, a folio plate exhibiting the raceme and a leaf of the hybrid, the subject of the book. We shall not further notice all these than as to their amount, which, as stated above, is that the hybrid participates equally all the external characters of its two parents; as slight exceptions, however, the stigma in its shape resembles that of neither, and the corolla in the hybrid falls off before the anthers which it bears have parted with their pollen, and the hybrid is, in consequence, barren of seed; this, in both parents, is not the case, which are consequently sufficiently fertile of seeds. In examining the internal organisation of the three plants in their various parts, the professor has been unable to detect any difference; but his researches have enabled him to show the high beauty and admirableness of the anatomical details of these parts. We shall only notice further the ingenious and convenient mode in which Professor Henslow has displayed his descriptive details for the sake of prompt comparison. It is this:—

D. PURPUREA.
(The male parent.)
Large, cernuous.
More spreading.
Broader.
More hairy
Purple.

D. HYBRIDA.
(The offspring.)
Flowers, medium size, nearly horizontal.
Calyx, moderately spreading in flower, afterwards connivent.
Sepals, ovato-lanceolate, the odd one much narrower.
—, hairy on the margin.
Corolla, yellow ground, tinted with red.

D. LUTEA.
(The female parent.)
Small, more drooping.
Less spreading, at length more closed.
Narrower.
Less hairy.
Yellow.

And in this manner through all the parts: and the parts and dissections on one of the plates are displayed in the same three-columned conspicious manner. Likenesses and differences are by this mode of arrangement rendered instantly and palpably obvious; and it was anxiety to attain this point which led the able author of *Dendrològia Britannica* to adopt the peculiar and remotely similar mode of describing in detail which that really meritorious work exhibits. In conclusion, we have only to say, we have had the pleasure of cultivating a hybrid, very similar to that which forms the subject of Professor Henslow's pamphlet, and that that hybrid, like his, was altogether barren of seeds. — *J. D.*

M'Nab, William, Superintendent of the Royal Botanic Garden, Edinburgh, A.L.S. C.M.H.S. &c. : Author of "Hints on the Treatment of Hardy Evergreens:" A Treatise on the Propagation, Cultivation, and general Treatment of Cape Heaths, in a Climate where they require Protection during the Winter Months. 8vo, pp. 44, with a beautiful coloured engraving of *Erica aristata*. Clark, Edinburgh; Treuttel and Würtz, London; 1832. 2s. 6d.

We have read through this pamphlet, and shall offer no analysis of it; for this, besides occupying more space than we can spare, would be only acceptable to cultivators of this charming genus, and every one of these should procure and possess the work. It contains no specious theorising, but is a straightforward narrative of the results of the writer's long and extensive practical experience in his remarkably successful cultivation of this most charming genus.

Mr. M'Nab deserves the hearty thanks of all who are interested in the promotion of floriculture, for having shown so clearly by what simple means the Cape heaths can be grown healthily and vigorously, and therefore satisfactorily. A feeling of misery is ever associated by a sight of sickly exotics; and one tuft of native heather, luxuriating in health and beauty, is a far more pleasing object than a house full of such; but how delightful must be the sight of Mr. M'Nab's collection when the majority of species is in bloom! They seem unafflicted by sickness and debility. "There are," says he, "in the Botanic Garden, at Edinburgh, heaths 8 ft. high, in tubs 3 ft. over; and the plants are both bushy in proportion to their height, and in great vigour; and these, when in flower, are covered with blossoms from the edge of the tubs to the top of the plants. These are, however, the freer-growing kinds, such as *Erica Eweriana*, *Bonplandiana*, *abietina*, *vestita coccinea*, *grandiflora*, &c." The book is indeed cheap. — *J. D.*

Since the preceding notice was written, a valued correspondent has supplied the following remarks. They corroborate our own, and also take additional views:—

It may justly be said of Mr. M'Nab, "that he is a man of that stamp that would not write on any department of gardening, unless he could show the good effects of it in his own practice;" a compliment which he is pleased to pay (p. 7.) to Mr. Walter Henderson, gardener at Woodhall. To the justice of this remark the beautiful heaths at the Royal Botanic Gardens of Edinburgh bear ample testimony. From some supposed difficulty in the proper treatment of heaths, that beautiful family of plants has certainly not met with the general encouragement which their splendour, and simple and cheap mode of culture, seem to warrant. The excellent little treatise now before us will, we doubt not, soon prove the means of exciting a taste for, and of extending the culture of, the heaths

of the Cape, "every species of which is beautiful throughout the year, and at every period of its growth, in flower or out of flower, and of every size and age." (p. 6.; quoted from the *Gardener's Magazine*, Vol. I. p. 366.) Mr. M'Nab's method of striking heath cuttings is nearly the same as practised in the Leith Walk Nurseries about the commencement of this century, with this difference, that Mr. M'Nab "very seldom uses bell glasses." These, we recollect, were uniformly then used in striking heaths, and required much attention in "wiping, to prevent any damp from injuring the cuttings." For the directions given as to the general mode of propagation we must refer to the work itself. The soil which Mr. M'Nab "has found Cape heaths thrive best in, is a black peat soil, taken from a dry heath or common which is never overflowed with water. In general it should not be taken off more than 5 or 6 in. deep. It frequently happens that peat earth has sand mixed with it in its original state; but where this is not the case, a quantity of coarse white sand should be procured, and mixed with the earth in the compost ground, to the extent of one fourth or one fifth of the whole." (p. 16.) His mode of shifting, and of raising the plant above the level of the pot, is illustrated by a woodcut, and merits attention by the cultivator of green-house plants in pots. What, however, will have a tendency to extend the culture of heaths more than any thing in this excellent little treatise is, an assertion from such high authority, that "heaths require but little fire heat during winter." "I have," he says, "several times had the heaths here in winter without fire heat, when the thermometer out of doors stood at 16° below freezing; but in these cases the house was always shut close; and I have never seen the heaths suffer from this cold. I have had the whole heaths in the house frozen, for days together, so hard, that the pots could not be removed from their places without breaking them, and fresh air constantly admitted at the time, and I have never seen one of them suffer in the smallest degree from it." (p. 31.) We think we do our horticultural readers a service in noticing the merits of this most unassuming and practical treatise. The ladies will observe an elegant drawing of the *Erica aristata*, at the beginning, by Mr. James M'Nab, the son of the intelligent author, well worthy of the price of the book. — *G. Perthshire.*

Chandler and Booth's Illustrations and Descriptions of the Camelliææ. In Imperial 4to Parts, every three months. 7s. plain; 10s. coloured; and 18s. extra-size.

Part X. for November, contains

37. *Caméllia japónica Róssü*, Ross's Japanese Camellia. This desirable variety is well described in our Vol. I. p. 211., under the name of "*Ross's Caméllia gloriösa*;" and an interesting biography of the late Mr. Ross himself is given Vol. I. p. 95. "The flowers are generally very large and showy, often measuring 4 in. in diameter." In form they much resemble those of *C. japónica élegans*, see Vol. VII. p. 343., but in colour they are of a much deeper and darker red. — 38. *Caméllia japónica Aitöni*, Aiton's *large single red* Japanese Camellia. This, "and four others, were raised at the Vauxhall Nursery from seeds contained in a capsule of the Pomponne Camellia, and sown in November, 1819. It was named in compliment to Mr. Aiton, the king's gardener, and "is, unquestionably, a very striking variety, and a most valuable one to the cultivator of camellias, on account of its producing seeds more freely than any other kind whatever." — 39. *Caméllia japónica crassinérvis*, Thick-nerved Japanese Camellia, conventionally *Kent's hexangular* Camellia, both from its having first blossomed with William Kent, Esq., when he resided at Clapton, and from its "having been supposed, on its first introduction," which is believed to have been made by Captain Rawes, about 1820, "to be the hexangular variety so much esteemed by the Chinese." In its blossoms only different from the *Warratáh* in its

outer petals being paler, and more cupped; in "habit and foliage," however, "the two kinds are perfectly distinct." — 40. *Caméllia japónica epsonénsis*, Epsom Japanese, or *Young's semi-double red*, C. Raised by Mr. Young of Epsom, previously to 1824, as in that year he presented it to the London Hort. Soc. Robust in habit; its flowers much like those of the semi-double red, but of a deeper colour and more petals; but is very prone to vary in the number of the petals. "When the petals happen to be numerous, the cup of stamina is partly transformed into small, roundish, spathulate, striped red petals, all of which, as well as the large outer ones, are pretty evenly arranged over one another, and distinctly marked with dark-coloured veins. The usual colour of the flowers is a deep red, approaching to scarlet," and they are about 3 in. in diameter.

The present part concludes the first volume, and contains titlepage, preface, table of contents, introduction, and remarks on soil, propagation, and culture. "All these," say the authors, "it is hoped, will make the first volume complete in itself, and render it independent of the second one; the publication of which, from several unforeseen events, we are reluctantly obliged to postpone for the present. We cannot, however, allow the present opportunity to pass, without acknowledging our obligations to those who have honoured the work with their patronage and support. At a future time, we trust again to appear before the public, and hope our labours will meet with the same flattering encouragement."

Of the forty kinds of *Caméllia* figured and described in this first volume the authors denominate as

Species: *Caméllia japónica*, *maliflora*, *oleifera*, *reticulata*, and *Sasánqua*.

As *Chinese varieties* of *Caméllia japónica*: *álba semiduplex*, *álba flore pleno*, *anemoniflora*, *àtro-rubens*, *rosea*, *crassinervis*, *fimbriata*, *imbriata*, *incarnata*, *myrtifolia*, *pæoniaeflora rosea*, *Pomponia*, *rubra plena*, *speciosa*, *variegata*, *Welbánkii*.

And as *English varieties and hybrids* of *Caméllia japónica*, the following: *flore álbo*, *Aitoni*, *althæiflora*, *anemoniflora álba*, *Chándleri*, *concerna*, *corállina*, *eclipsis*, *élegans*, *epsonénsis*, *eximia*, *florida*, *insignis*, *punctata*, *Rosa sinénsis*, *Róssii*, *spléndens*, *Wiltóni*, *Woodsii*.

The figures of all these kinds "have, with only two or three exceptions, been made from plants in the splendid collection of Messrs. Chandler, nurserymen, Vauxhall." The remarks on the propagation and culture of the *Camelliæ* are very good.

Haworth, A. H., F.L.S. H.S. &c.: *Narcissinearum Monographia*. The 2d edition with additions and improvements, 8vo, pp 30. Ridgway, London, 1831. 2s. 6d.

To the notice of this useful *Monograph of the Narcissinean Plants*, given in Vol. VII. p. 479., the only addition necessary is, to say that the second edition excels the first, in being free from many typographical errors which haste occasioned in the first; in having some of the descriptions rendered more perfect; in having received the insertion of "many material new varieties, four of which may prove new species;" and in having four pages of preface on the history and culture of narcissinean plants prefixed to it. — *J. D.*

Catalogue of the Fruits cultivated in the Garden of the Horticultural Society of London. 8vo, pp. 81, 2d edition. Hatchard, London, 1831. 8s.

We noticed the first edition of this catalogue (Vol. II. p. 208.), and blamed the alphabetical arrangement as half scientific and half popular. The present edition is entirely popular; the fruits being arranged according to the names in common use, and not according to those of botanists. But this is not the only improvement; "by columns and abbreviations the meaning of which is explained under every different kind of fruit, a large number of the most important characters by which the varieties are

distinguished has been compressed into a very small compass. Thus, in apples, the following line —

846 Oslin p.y roundish 2 T 1 Aug. Sept.

signifies that the Oslin is a pale yellow apple, of a roundish figure, of a middling size, used for the dessert, of the first quality, and ripening in August and September. To these abbreviations a few useful remarks have often been added in a separate column.

In the former edition, a number of fruits, both of hardy and of tender kinds, were comprehended which are here omitted; such, for instance, as bilberries, hawthorns, brambles, oranges, guavas, and the like. They have now been left out for several reasons. By far the greater part, although eatable, are not fit for cultivation as fruit; such as hawthorns, brambles, and whortleberries, which ought only to be found in an enumeration of trees and shrubs; others can scarcely be considered eatable at all, as viburnums and many of the American grapes; and a third class is cultivated in this country for the flowers rather than the fruit, as the orange tribe. But what has chiefly caused the omission of the latter, and of other tender fruits, has been that in the present state of the gardens there are no means of cultivating them, with a view either to fruiting or to distribution. To this there is only one exception in the purple guava, or *Psidium Cattleianum*, which occupies a permanent situation in one of the vineries, where it bears abundantly.

In conclusion, it is due to Mr. Robert Thompson, who has the charge of the fruit department in the garden of the Society, to state that the value of this catalogue, whatever it may be, is principally due to his assiduity and pomological knowledge."

We have no hesitation in saying that this is by far the most valuable work which the Society has published; indeed, we should not be far wrong if we were to say that it is worth all their other works (seven 4to volumes of *Transactions*) put together. It is, in short, the attainment of the most important office for which the Society was called into existence. As the Society gives away scions and cuttings of fruit trees and shrubs freely to all nurserymen, it will now be their fault, or that of their customers, if the best varieties of every hardy fruit are not soon substituted for the bad or indifferent sorts now in general use, all over the temperate climates of both hemispheres.

Callow, Edward, Gardener upwards of thirty years to the late Lord Glastonbury, and afterwards to the Hon. and Rev. George Neville Grenville: *Observations on the Methods now in use for the artificial Growth of Mushrooms, with a full Explanation of an improved Mode of Culture, by which an abundant Supply may be procured and continued throughout every Month in the Year, with a degree of certainty which has in no instance failed.* 8vo, pp. 46, 1 pl. Fellowes, London, 1831. 7s. 6d.

It is easy, the author observes, to grow mushrooms in the autumn, when the atmosphere is congenial to their growth; but for summer and winter produce, the delicate habits of the mushroom require a nicety of management which few have been able to attain. That they have hitherto been found delicate things to force, and that to obtain them at all seasons has been a matter of some uncertainty, those who are best acquainted with raising them well know. Mr. Callow, having succeeded in obtaining winter and summer supplies of mushrooms in great quantity, at little expense, and subject to no uncertainty, "is induced on that account to lay before the public the result of his experience." The uncertainty in cold-beds has arisen from the want of bottom heat, and from damp; and the uncertainty in houses warmed by fire flues, may be attributed to the arid

state of the atmosphere. As mushrooms disappear in the fields for the season, after a single sharp frost, so it will be found difficult to recover a bed after it has once suffered any severe check. From adverting to the causes of the frequent failures in obtaining crops, and from attentively considering the habits of the vegetable in its natural state, Mr. Callow abandoned "the most uncertain dung-ridge culture," and also the use of fire heat, and substituted the steam of hot dung in the mushroom-house; thus forming an atmosphere "somewhat resembling that of those close foggy mornings, which even the uneducated husbandmen, from observing effects, call 'mushroom weather.'" A damp heated atmosphere seems to be the desideratum to insure luxuriant crops throughout the year.

Thus much for the principle of Mr. Callow's improvement: to describe its application will be unnecessary to those who are in the practice of growing mushrooms in houses heated by flues. The inexperienced will feel themselves amply repaid by the purchase of Mr. Callow's work; or they may proceed on the following outline:—

Let a house for summer use face the N. or N.E.; for winter use the S. or S.W. If the soil be wet, use the proper means to render the floor of the house perfectly dry. Build the back and ends of stone or brick, the front of inch boards, plastered inside; and cover the roof with a thick coat of thatch. Leave an opening in each end for the admission of air at pleasure. In the roof, form two or more windows of small size, for admitting light, when watering or doing other work. Form a small doorway in the centre of the boarded front. From the doorway to the back wall there should be a trench 18 in. wide and 2 ft. deep, to be filled with hot dung whenever it may be necessary to increase the heat and moisture of the house. Shelves may be placed against the back and end walls, and flues formed across the floor 2 ft. deep by 18 in. wide, covered with boards or flat stones for receiving the steam of the dung; and other flues or vacuities may run along the ends and sides of the house at pleasure, by simply placing, in an inclined position, boards or flat stones against the wall. The bed in the floor of the mushroom-house, and those on the shelves, are to be made of properly prepared dung in the usual manner; and the same as to the planting the spawn, &c. A uniform temperature is to be kept up in the house, by outside linings of fresh dung, leaves, or grass; raised either only a few feet in height, or as high as the eaves of the roof, as the season or other circumstances may require.

It must be evident, we think, to every gardener, that this is a very certain and economical mode of raising mushrooms; and it may be proved in any common pit, or even frame, substituting thatched boards for the glass sashes.

Long after writing the above notice, we received the following from Mr. Elles, one of the most scientific, and at the same time successful, practical gardeners in either Britain or Ireland:—

"Sir, In the last Number of the Gardener's Magazine, no mention is made of Mr. Callow's *Treatise on the Growth of Mushrooms*; which treatise, I think, not only deserves to be mentioned, but likewise to be strongly recommended, so that it may become as generally and as universally known as its merits justly entitle it to be. These merits will be found both in Mr. Callow's practice and theory. In the former, his directions are so plain and clear, that I should think it almost impossible to misapprehend his meaning; while in the latter, if any other guarantee besides the high and well known respectability of his character, both as a man and as a first-rate gardener, were wanted to prove the correctness of it, confirmation would be found in the partial application of hot steaming dung, either for heating mushroom-houses or filling them with moisture, by many excellent mushroom-growers; who, although they could in some measure appreciate the value and utility of this kind of moist heat, yet had

not so fully and practically developed the theory as Mr. Callow has now done; for which, I think, he deserves the thanks of gardeners generally.

However, notwithstanding the very great credit due to Mr. Callow, for a book which every gardener ought to possess who has mushrooms to grow (and who has not?), yet there is still a desideratum to supply in this department; namely, a method by which mushrooms may be grown during the summer and autumnal months in the open air. Does any one of your readers or correspondents know of any person who has succeeded in this way besides Mr. Cunningham of the Comely Bank Nursery, Edinburgh? He, I believe, objects to a public disclosure of his method, for which, in a commercial point of view, he probably may be justified; but, as no such objection applies to a gentleman's gardener, I hope some one or other of the brethren will come forward and give us the required information. If not, after having augmented my "little modicum of learning," by a perusal of a few more of your publications, and another season's experience, I will endeavour to accomplish the task. I would indeed now very readily give you the particulars of my proceedings during the late season, had it not been so extremely favourable to the growth of mushrooms, that to attribute the crops I grew from the middle of June to the middle of November, in the open air, entirely to previous management and preparation, would, I think, not be fair. However, be that as it may, many gardeners witnessed my crop with astonishment. From a space 40 ft. in length, and 7 ft. in width, I have frequently gathered 4, 8, 10, and even 12 pecks of mushrooms in a morning. — *J. Elles. Palace Gardens, Armagh, Dec. 23. 1831.*

Lambert, Joseph, Esq.: Rural Affairs of Ireland, &c. 12mo. Curry, Dublin, 1830. [Previously noticed *G. M.*, Vol. V. p. 540.]

This is really an excellent little volume, admirably adapted to the present circumstances and exigencies of Ireland. The author is evidently a clear-headed practical agriculturist and rural improver, for there is scarcely a single page which does not contain some useful rule, or some valuable practical information; indeed, the book altogether is nearly an epitome of all that is essential to the well-being and well-doing, under ordinary circumstances, of the peasant, the farmer, and the landlord; and no Irishman who has a spark of pride in, or patriotism for, his own or his country's weal, should be without it.

His chapters on the Profits of Farming, System and Regularity, Roads, Draining Land, and Manure, clearly show that the author is thoroughly acquainted with these important subjects, by the manner in which he appreciates the immense advantages the farmer will have who may carefully attend to these matters. In his chapter "Lime as a Manure," he says, "an experienced writer on this subject states, that he has had many opportunities of observing total barrenness produced by a too liberal use of it; but, if introduced with judgment, it will produce very useful permanent changes in the soil to which it is applied." Now, after such an observation, surely the author, without risking the charge of introducing useless verbiage, might have been a little more explicit on the subject; for there is no manure, stimulant or alterative, whichever it may be called, so universally employed as a manure on arable land; and the least hint insinuating the possibility of mischief arising from its use, might cause the indolent or injudicious to abstain entirely from using it. He ought, where a positive evil had occurred by its application, to have submitted a remedy, and informed his readers that a dressing of peat-earth would have almost immediately corrected the evil, by offering a medium through which the caustic properties of the lime might become a source of fertility instead of barrenness; and, above all, the different quality of lime made from magnesian limestone, which is common in Ireland, and that which is made from common limestone, should have been pointed out. Quicklime of any kind,

applied to land deficient in vegetable and fibrous matter, will most assuredly prove injurious; without such matter, the lime will retain, for a long time, its caustic properties. It is this fibrous and vegetable matter which yields the carbonic acid, with which the quicklime combines and ultimately becomes mild, or carbonate of lime; and it is during the process of this combination that the greater part of this vegetable and fibrous matter which was insoluble is converted into soluble or fertile matter. Afterwards the mild or carbonate of lime operates, as a manure, in a directly contrary way to quicklime: quicklime, by rendering matter which was inert, nutritive; mild lime, by retarding the too rapid decomposition of those very substances which, in its conversion from quick to mild lime, it had decomposed.

If, then, it should appear that some judgment is necessary in the proper application of common lime to agricultural purposes, and every farmer will admit that he is frequently puzzled how to apply it; must not the difficulty be infinitely greater when he has to apply lime made from magnesian limestone, in which the affinity for carbonic acid is considerably less? Thus, in the application of lime made from this stone, while any, the least part, of the lime remains caustic, it attracts carbonic acid from the magnesia, consequently the magnesia must and does continue caustic and poisonous for an indefinite period; at least until peat or some other vegetable matter is applied to afford a proper supply of carbonic acid, by which alone it can be rendered beneficial or fertilising. It may be considered that these observations, if not irrelevant, are, at least, too minute on such a subject; but, as the use of lime as a manure is so general, perhaps they may not be altogether out of place. The chapters, Salt as a Manure, Burning Land, Fallowing, Top-dressing Grass Land, Ploughing, Rolling and Pulverising Land, are short, pithy, and useful; but, under the head "Weeds," the author has unfortunately substituted Sir H. Stewart's method of extirpating rushes instead of following the dictates of his own good sense. Sir Henry's scheme for banishing rushes it seems, is nothing more or less than deep-trenching the whole of the ground producing rushes. "It is by deep-trenching to the depth of 18 or 20 in. that the tenacious clay at bottom is broken up, and the cause removed, when the subsoil is rendered porous for the surface water to pass freely downwards. The bottom of the trench should be carried on a hanging level, and the sandy or stony parts of the soil thrown towards the bottom, which will be a sufficient drain, and render the land dry."

Now, it may not be always possible to find this "hanging level" (which, by the by, sounds like a Hibernicism); and suppose it were found, can any idea be more preposterous than that trenching a pasture, say from 10 to 30 acres, no less than from 18 to 20 in. deep? Judicious draining will effect the same object, at a fiftieth part of the expense. Rushes may be kept under, if not entirely eradicated, by mowing them either in the spring or autumn in frosty weather, mornings or evenings: even flooding*, as in water-meadows, will destroy them; as rushes will not grow in either very wet or very dry ground, but delight in ill-drained land with a strong retentive subsoil.

The remainder of this little volume, which relates exclusively to farming, includes the most approved modes of rotatory cropping: indeed, nothing useful seems to be omitted; even the "prognostics of the weather" are happily introduced, with many useful and intelligent remarks. The breeding and rearing of cattle, and the treatment most conducive to their health in a wet climate such as Ireland, form no inconsiderable portion of the work. An excellent plan of a sheepfold is given, which the author has proved to answer well the end for which it is intended. However, there

* The reviewer plainly means *Juncus glaucus*; for *Juncus effusus*, a species prevalent in some places, loves water too well to be ever killed by irrigation. — *J. D.*

is one remark respecting the management of sheep, which may be exceptionable; it is this:—"Ewes should, if possible, have some green food before and after lambing." Now, to give green food *before* lambing is in England considered a dangerous practice. The ewes, under such treatment, *yeau well*, but soon after are taken with a *heaving*, as if about to yeau a second time; twenty-four hours, or less, usually puts a period to their existence, and nothing hitherto discovered will effect a cure. The only preventive is to put the flock on dry food.

We now come to "Observations on reclaiming Bogs and Wastes." In this important chapter the author has shown what portion of bogs may with propriety be attempted, and with certainty be reclaimed. With a perfect knowledge of the nature of these bogs, the habits, wants, and industry of the numerous peasantry, he has, in addition to these, brought all his experience on rural affairs to bear on this subject, and made it one of the most interesting chapters in the volume. As an improver of wastes, he equally avoids the vapid declamatory nonsense of enthusiastic theorists, and the indolent admirers of things as they are: he proceeds in a business-like manner; like one who is aware of the difficulties with which the subject is beset, but is, nevertheless, confident in the resources of his own mind, and the almost boundless resources which Ireland affords. He shows what immense improvements might be effected in Ireland, by the proper application of capital. On this subject his work should be consulted by every man who may have an acre of bog. It is not a little curious, likewise, when on this subject, to observe with what ease and most perfect *sang froid* he exposes the utter ignorance of those Katerfeltos who send their nostrums by dozens across the Channel, each of which would, as they profess, if properly administered, insure not only the regeneration, but the complete salvation, of Ireland. Nor does even honest John Bull escape a sarcasm or two about his "frothing tankard and fat bacon,"—(May he ever have plenty of both!)—and when his condition is contrasted with that of the labourer of Ireland, the author, with national pride, claims some degree of happiness and comfort for his own poor despised countrymen, who dwell in cabins as foxes in holes; and such a claim is both just and commendable, for they certainly are neither so unhappy nor so wretched as their appearance would seem to indicate: but that the poverty of the Irish peasant is great, his privations numerous, and, to an Englishman, unbearable and maddening, no one acquainted with his condition will deny; yet his native good-humour and buoyant spirits enable him not only to prolong and enjoy his existence, but in some measure to compete in point of happiness with his better fed English neighbour. But an Irish peasant's happiness is that sort of happiness which may Heaven ever avert from the shores of Britain! it is that sort of happiness under bondage, which is described in *Don Juan* as being exhibited by the blacks, in contradistinction to the whites, in the slave mart, where the noble author says:—

"The negroes more philosophy display'd,
Used to it, no doubt, as eels are to be flay'd."

And used to oppression he is indeed; for, although the maxim "live and let live" is understood and acted upon by many kind and benevolent resident landlords, yet the sentiment is exotic, and a grasping overreaching disposition is the general characteristic of this grade of society. The absentee landlords exact exorbitant rents from the small farmers (and if a man rent but half a dozen acres of ground, he is called a *farmer* in Ireland); while the middleman, or large farmer, with from 50 to 100 acres, or upwards, acting, as in many parts they do, upon the con-acre system, oppresses the peasant, and injures the land for years, to enrich himself. By these and such like grinding and oppressive means, the intellects of the peasantry are whetted to a degree of acuteness in fraud and deception unknown in England. If it is possible, an Irish peasant will cheat or overreach a customer

in making a bargain, and that, too, without the least misgiving or compunction; however, as example is more impressive than precept, it is possible that he may have been instructed by his superiors: be that as it may, that the delinquency is general, will admit, if not of positive proof, at least of illustration, however ludicrous, that may be considered tantamount to it. A Yorkshire horsedealer is generally considered a shrewd clever man in his calling; but let him once set his foot on "this first flower of the earth, and first gem of the sea," and his "occupation's gone;" in fact, he would soon lose his teeth! Again, a descendant of Abraham is not to be met with between the Giant's Causeway and Cape Clear; he is indeed a nondescript: he who peregrinates every region of the globe, "to buy and sell, and get gain," cannot exist in this country! However, St. Patrick may have included these worthy personages in his denunciation against venomous reptiles, and that will account for their absence.

Let us take another view of the inmate of the cabin, for he may be found of all tints. Observe the half-clad peasant, breasting the storm with wiry sinews, his ragged coat streaming in the wind, travelling to some neighbouring market with a load on his shoulders. This load is a web of linen cloth, for which, should he be fortunate enough, he may obtain from 6*d.* to 10*d.* a yard.

And this trifling sum is all that this man obtains for a yard of cloth, after having grown his own flax on land, for which he must pay from thirty to eighty shillings per acre; after the labour attending the pulling, watering, drying, crigging, dressing, spinning, weaving, and taking to market. Then, with the proceeds of the sale of this cloth, together with the sale of his corn, for these men generally rent three or four acres of ground, he contrives to pay his rent; while himself and family live, or rather drag out a miserable existence, entirely on potatoes; for his ducks and fowls, geese and turkeys, are all brought to market to enable him to purchase something to cover his nakedness with; nor will his utmost exertions enable him to procure better fare.

Here, then, is degradation! Here is debasement! A fellow-creature, gifted by the Almighty with all the essentials of manhood equal to the proudest sons of earth, is thus bowed down to, and made to bite, the very dust. Is it surprising, then, that such a man, smarting under the effects of such brutalising wretchedness, his "passions wild and strong,"—is it marvellous, then, that such a being should equal the Indian in artifice and cunning, or in ferocity, when his passions are tumultuously excited by designing demagogues, who, by and through the grossest superstition, have obtained such a mastery over his affections, that even in the very whirlwind and tempest of his passions they can control and mould him to their will? Nor does there appear any hope of amendment, unless the benevolent resident gentry combine with the commercial people, as they are now beginning to do, to extend the benefits of education: for it is the latter class of men that will eventually operate as a lever to raise their humble brethren from such a state of thralldom and degradation; for the great majority of this class are well educated, kind, open-hearted, high-minded, hospitable, generous, and charitable. They possess not only a high sense of honour and integrity, but a proper and an exalted sense of the relative duties of man. Let then but such a class of men earnestly set their shoulders to the wheel, and the work is half done; for until there is an improvement in the moral condition of the peasantry, English capital will flow but tardily into Ireland, and without it the reclaiming of bogs and wastes will proceed but very slowly.

"Observations on Forest Trees in general." It would amount to an almost positive injustice to quote a single passage from this portion of the work. The author under each head has given plain and practical directions respecting the culture of the various forest trees; and besides he has in-

terspersed numerous historical notices of fine old trees in various parts of the empire, which are extremely interesting and valuable: and, what is of more consequence, no idle fantastic theories, or pompous passages descriptive of trifling details in daily operations which are self-evident to a labourer of the meanest capacity, are introduced to swell the number of pages; but plain common sense pervades each chapter. He writes as if he considered his readers sentient beings; and, when he has pointed out the principle upon which each operation ought to be conducted, leaves the manipular part to the "ignorant and self-sufficient gardener," or forester, as he very properly ought to do. This brings us to the chapter "Transplanting Large Trees," and the praise-bespattered "Allanton method." Our author warmly eulogises Sir H. Steuart, and says, that "he has brought about a new era in this department of arboricultural science." It is charitable to suppose that he merely echoes the sentiments of the northern reviewers, who, of all men, are the most accommodating to each other's wants and wishes. "Caw me, caw thee," has worked well for the booksellers for many years, and is now as proverbial in criticism as it formerly used to be, when it afforded a ready and convenient mode of introduction to a mutually useful interchange of civilities. So that, we presume, even under the fearful responsibility of dissenting from the opinions of such "learned" men, to say, that, if this "new era" means any thing *new* in forestry, we are at issue with them, and will very soon put this claim to originality to the test, by asking one plain question: — Has Sir H. Steuart developed, by this supposed new method, one new, or rather any one imperfectly understood, principle in vegetable physiology? New principles there are none; they ever remain the same: let his panegyrists answer the question. When the first man and the first gardener sprang from the hands of his Maker, it is reasonable to suppose that he was endowed with a sound mind in a healthy body; and if so, he practised the "Allanton method:" for every gardener with common sense, whether in Paradise, China, or Japan, England, Scotland, or Ireland, has practised, and must of necessity practise, upon principle, the identical method which has given so much celebrity to Sir H. Steuart; a "learned author," forsooth, who has written a book setting forth as new that which is old, and endeavouring to raise his character for intelligence by the basest of all means, namely, by slandering and depreciating that of the humble and comparatively defenceless gardener. This is "the unkindest cut of all." What! shall such men as M'Nab, Gorrie, Howden, Milne, Munro, Plimley, Burn, Forest, M'Intosh, and a host of others, be stigmatised as "ignorant and self-sufficient gardeners?" If such a foul aspersion had not come from so high and "learned" a quarter, it were too contemptible for notice. What! and we reiterate the exclamation, shall a race of men be falsely branded with the vulgar epithets of "ignorance and self-sufficiency," who are proverbial for intelligence and virtuous integrity? — a race of men unequalled, in any other profession, for self-denial, and the most unconquerable perseverance in overcoming difficulties, which only men with such indomitable spirits and unwearied industry can surmount; is it meet, is it just, that such men should be scandalised by such a calumny?

Away, then, with such vituperative and malignant aspersions; or let them recoil on the head of the original promulgator. Why, we ourselves assisted, some twenty years ago, in transplanting some very large trees in the old Botanic Garden in Leith Walk, under the above-named unassuming, but excellent man, Mr. M'Nab, without ever once thinking that there was any thing wonderful or even surprising in the operation; for we had frequently seen the same thing done in England before. But Sir Henry and his reviewers, it seems, not being satisfied with the just renown which the "sons of the mist" have most meritoriously acquired, they must arrogate to themselves the discovery of nearly every improvement, or improved mode

of management, in rural affairs, and even go so far as to call in to their aid some lackadaisical peripatetics from the Highland Society to bolster up the monstrous absurdity, who sapiently and profoundly agree that the "Allanton method" is to supersede all other modes of "economical planting," and that it is to produce a new era in "ornamental planting."

Shades of Pope and Shenstone! could ye but for once "revisit the glimpses" either of the sun or "moon," how would your beatified spirits mourn! — ye who,

" Looking through Nature up to Nature's God,"

employing nature's simple instruments, realised beauties which could only previously exist in the "mind's eye" of such heaven-born souls, — how would ye mourn (being ignorant of the "Allanton method," as in good truth ye needs must), — how would ye mourn to find your own sylvan scenes — your own poetic fairy lands — neglected, despised, and depicted but as "possessing things rank and gross in nature merely." Even the magnificent and hallowed conceptions of England's own blind bard must vanish into "airy nothing" before the Ithuriel touch of these magical arborists. But enough, and more than enough, of this matter.

We will close these observations with a short extract from the chapter on pruning, to show our fellow-labourer Mr. Howden, and others, that our opinions respecting the management of the pine tribe are not singular. The author says: —

"I am decidedly averse to pruning any of the fir tribe, except decayed branches, to prevent useless knots in the timber. It is much better to leave all firs to nature, as their sap-vessels are larger than those of hard-wood trees, and they consequently bleed more when wounded; besides, it makes a ridiculous and unsightly appearance to prune a parcel of fine larch and other firs, as I have frequently seen them, three parts of the way to the top. The branches of the larch are weak and tender when planted in mass, and therefore do not cause large knots in the timber; in no case, therefore, should they be touched. The silver fir, the next in value, and in every way one of the noblest of the pine tribe, I have seen pruned, and bleeding from the numerous wounds which the ignorant and injudicious hand had inflicted on it. — *Thin out your firs regularly; but, so far as regards pruning, hang up your saw, and lock up your pruning-knife. Regular thinning is more to be recommended for all trees than too liberal an application of the saw or pruning-knife.*" — J. Elles. *Palace Gardens, Armagh, Jan. 5. 1831.*

Cleghorn, James, Esq., an Accountant in Edinburgh, late Editor of the "Farmer's Magazine:" System of Agriculture, from the "Encyclopædia Britannica." 4to, pp. 106, 7th edit., 13 quarto plates. Edinburgh, 1831, Adam Black.

We have great pleasure in noticing this work, written and published by highly esteemed friends. It may be considered as a specimen of the new edition of the *Encyclopædia Britannica*, now publishing by Mr. Black, which is unquestionably far superior to the preceding one, in paper, print, and engravings, as well as in matter. We regret chiefly one thing: viz. that instead of engravings on plates separate from the text, and which, being troublesome to refer to, are generally not referred to at all, woodcuts in the body of the text have not been used. We should have preferred, also, a systematic arrangement, somewhat in the style of the *Encyclopædia Metropolitana*. A quarto encyclopædia, of twenty or thirty volumes, in which the subjects are systematically arranged, and all the engravings, except those of maps, and a few views in which aerial perspective is essentially necessary, done on wood, is a desideratum in English literature, which we trust will be supplied as soon as government reduces the tax on paper.

Dewhurst, W. H. Esq., Surgeon-Accoucheur, Author of a Dictionary of Anatomy, Physiology, &c.: Practical Observations on the New System of warming Dwelling-houses, Cathedrals, Churches, Theatres, and other Public Buildings, with Hot Water; together with a Description of the dangerous and uncertain Effects produced by the Employment of heated Air; to which is added, some Remarks on the Importance of an equality of Temperature, and Cure of Cholera and other Diseases. London, 1832. Printed for the Author, 8. Gower Place, Euston Square. 2s.

Mr. Dewhurst is warm in his recommendation of hot water as a means of heating. He quotes Dr. Arnott, whose *Elements of Physics* every gardener who can afford it ought to possess, to show that "a fourth part of the fuel generally expended in English houses, if more skilfully used, would better secure comfort and health than all which is now expended." Mr. Dewhurst speaks of a Major-general Viney's boiler, as if it were the *ne plus ultra* of perfection, and as affording sufficient room for the "perfect combustion of the fuel." We should wish Mr. Dewhurst to explain to us, in a few words, how the combustion of fuel can possibly be perfect, immediately under or beside any hot-water or steam boiler whatever; the thing is impossible, for reasons which we have given in page 26. Mr. Dewhurst's tract deserves to be read, if it were only for his remarks on the abodes of the poor.

ART. V. *Literary Notices.*

LOUDON'S Encyclopædia of Cottage, Farm, and Villa Architecture, with Critical and Analytical Remarks on the Application of the Principles of Architecture to these Kinds of Buildings; and on Landscape-Gardening as connected with Buildings generally. — It will be seen from our Advertising Sheet that we have commenced this work in Numbers, to be continued quarterly. We have no doubt of rendering it one of the most readable books on Architecture in the English language; and one which, more than any other on the same subject, will diffuse a knowledge of the principles of Architecture, and a taste for its productions among general readers. The following are extracts from the introduction: —

The main object of this *Encyclopædia of Cottage, Farm, and Villa Architecture* is to improve the dwellings of the great mass of society, in the temperate regions of both hemispheres: a secondary object is to create and diffuse among mankind, generally, a taste for architectural comforts and beauties. The means by which we propose to accomplish these objects are the following: — 1. By submitting a Series of Designs for human dwellings, embracing the greatest variety of comfort and beauty; and accompanying these designs by analytical and critical remarks, pointing out in what this comfort and beauty consist, and on what principles both are founded. 2. By a General Survey of the present state of Cottage, Farm, and Villa Architecture throughout Europe, in which the forms and arrangements adopted in different countries will be traced to the climate, materials of construction, and other circumstances, of each particular country; and conclusions drawn respecting those arrangements and forms, with a view to the improvement of architectural design. 3. By an Analytical and Critical Examination of the principal works hitherto published on the subject of cottage, farm, and villa architecture; pointing out what we consider the defects, deformities, or beauties, in the engraved designs of those works; and what we think erroneous or right reasoning, in their dissertations on taste and beauty. 4. By a developement of the Grammar, General Principles, and Technical Details of Architecture, in such a manner as to render them familiar to the general reader, and subservient to the purpose of educating young persons in Architecture, especially the female sex.

We have commenced our work with Designs, rather than with Principles;

because, in the analytical and critical remarks, with which we mean to accompany these Designs, we intend to develope, as it were, incidentally, and by little and little, all the principles of Architecture; and also those of Landscape-Gardening as connected with buildings. We consider this mode of instruction as best calculated for those practical men who have not had a sufficient education, or have not pursued such a course of reading in early youth, as would enable them to enter at once on the perusal of discussions, which must necessarily be, to a considerable extent, metaphysical. We also consider this mode as by far the best adapted for initiating the general reader in the principles of architectural taste; and for enabling young persons, and especially ladies, to educate themselves in Architecture, as an elegant art.

The improvement of the dwellings of the great mass of society throughout the world, appears to us an object of such vast importance, as to be well worth attempting, even though we may not all at once succeed to our utmost wishes. In ameliorations necessarily involving considerable expense, much cannot be expected to be performed immediately; yet, by making known the various particulars in which these ameliorations consist, to those who are to derive important benefits from them, we may rest certain that, sooner or later, they will be effected. The efforts of Architects, in all ages and countries, have hitherto been, for the most part, directed to public buildings, and to the mansions of princes, noblemen, and men of wealth; and what have hitherto been considered the inferior orders of society have been, for the most part, left to become their own architects. Hence the tardiness with which the improvements made in the accommodation, arrangement, and exterior beauty of the mansions of the wealthy, have found their way to the dwellings of the poor. The great object of this work is, to show how the dwellings of the whole mass of society may be equalised in point of all essential comforts, conveniences, and beauties.

After studying with care all the various opinions delivered by different architectural writers on the subject of the principles of their art, and divesting ourselves, as much as possible, of all accidental associations and temporary prejudices, we have arrived at the following conclusion:— that the leading principle of Architecture, as a useful art, is fitness for the end in view; as an art of design, expression of the end in view; and, as an art of taste, expression of some particular architectural style. Those beauties or effects which are the result of the first and second principles, are in their nature permanent; those which are the result of the third principle, are in their nature temporary and accidental.

All the various principles which come into operation, in the design and construction of buildings, easily range themselves under these three fundamental principles. The fitness of a design for the end in view comprehends not only the fitness of the size, shape, number, relative position, and other particulars of the interior divisions of a building, for the uses for which they are intended; but the fitness of the materials and construction, with reference to the strength and durability which may be required; and the fitness of the expenditure for the means at the command of the builder. In like manner, the principle of the expression of the purpose, or end in view, applies not only to unity of expression in a building as a whole, but to the separate expression of all the different parts of a building of the purposes for which they are intended. So also the expression of architectural style applies not only to the building taken as a whole, which must be in the same style throughout, but to all its component parts, which, even to the most minute details, must belong to that style, and exhibit its characteristics.

Thus, as there are various uses to which buildings are devoted, so are there various kinds of beauty of which they can be rendered expressive. But, as all the uses to which buildings can be applied, all the arrangements which are requisite for convenience or luxury, and all mechanical or che-

mical processes which enter into their construction, are referable to the principle of fitness; so all the different kinds of beauty of which they are susceptible, are referable either to the expression of purpose, or to the expression of style. A cottage or a barn, which are recognised to be such at the first glance, are so far perfect, as to the expression of purpose; but they may also be specimens of Grecian or Gothic Architecture, in which case, to the expression of purpose is added the expression of style.

As fitness and the expression of purpose are principles applicable to all buildings whatever; so fitness, the expression of purpose, and the expression of architectural style, comprehend all the beauties of which buildings are susceptible.

The principle of expression of purpose is of universal application in Architecture; and whatever building will bear the test of examination according to it, cannot but prove satisfactory to every unprejudiced mind, though it may not possess any of the beauties of architectural style. The minds of all men, however, are more or less subject to the prejudices of the age and country in which they live; and the prejudices of European Architects and their employers seem long to have been in favour of the expression of architectural style in building, rather than of the expression of use or purpose. This circumstance has influenced the general taste; and hence it is, that the critical observer, when looking at what is considered a fine building, instead of first examining whether it is expressive of the purpose to which it is applied, considers only whether it is intended to be in the Grecian, Roman, or Gothic style; and, having determined to which of these styles it belongs, he next examines whether the details of the building are in strict conformity with the best practice and precedents in that style. But according to the principles we have laid down, it will be seen that the Grecian and Gothic styles are mere accidents in Architecture; and are nothing more than the language which the Architect makes use of to convey his ideas. The expression of the purpose, for which every building is erected, is the first and most essential beauty; and should be obvious from its Architecture, altogether independently of any particular style; in the same manner as the reasons for things are altogether independent of the language in which they are conveyed. As in literary compositions, no beauty of language can ever compensate for poverty of sense; so, in architectural composition, no beauty of style can ever compensate for the want of expression of purpose. Every reasonable mind must feel this; for, as we have said before, the foundation of all true and permanent beauty is utility.

These principles we shall gradually develop in the four following Parts, into which this work is divided.

Part I. Designs for Dwellings in various styles of Architecture, and with different degrees of accommodation, from the cottage of two rooms to the villa of the English gentleman of wealth and refinement in the nineteenth century; accompanied by analytical and critical remarks, illustrative of the principles of Architectural Design and Taste on which these designs are composed, and of Landscape-Gardening with reference to their accompaniments.

Part II. The Geographical History of Cottage, Farm, and Villa Architecture.

Part III. The Literary History of Cottage, Farm, and Villa Architecture.

Part IV. The Grammar and Principles of Civil Architecture generally.

Glossarial Index. Every technical term and professional expression made use of in this work will be, the first time it occurs, explained and illustrated, if necessary, by an Engraving; and in the Glossarial Index, not only will all these terms be brought together alphabetically, but other terms of Architecture, and such terms of engineering, and of the fine arts, as are connected with Architecture and Landscape-Gardening, will be explained and illustrated in a similar manner. The study and comprehen-

sion of these terms, by young persons, will serve to increase the interest which they will take in architectural reading, and will contribute materially to their progress in architectural taste and criticism.

A General Index, in alphabetical order, will afford an easy and detached reference to the whole work.

Supplement to Loudon's Hortus Britannicus, in 24 pages 8vo, appears with the present Number. It is a work of great labour, for the materials of which we are under the greatest obligations to almost all the botanists and nurserymen about London.

Practical Hints on Landscape-Gardening, with some Remarks on Architecture, as connected with Scenery, with Plates, by W. S. Gilpin, Esq., are preparing for publication. This work, we are sure, will be perused with interest; we hope it will not be published at such a price as to preclude its falling into the hands of practical gardeners.

The Mushroom and Champignon illustrated, compared with, and distinguished from, the Poisonous Fungi that resemble them. Containing five plates, with their descriptions. By J. Sowerby, Jun. In small quarto; price 1s. 6d. plain, or 2s. 6d. highly finished in colours. This work will possibly have been published ere this notice of it meets the light. The reasons assigned for undertaking it are the following:—"As accidents are frequently occurring by mistaking the poisonous for the eatable fungi, particularly the *Agaricus viridus*, one of the most poisonous and most common, for the champignon; and as many people, not knowing the distinctions, are afraid of using any, it has been suggested that a work pointing out the differences, in a manner that shall be intelligible to every one, would be generally useful, it is therefore hoped that the little work just offered to the public will be productive of good effects."

ART. VI. *Notices of new Plants, or of interesting old ones, derived from the British monthly Botanical Periodicals for February and March, 1832, viz. —*

Curtis's Botanical Magazine; each monthly Number containing eight plates; 3s. 6d. coloured, 3s. plain. Edited by Dr. Hooker, King's Professor of Botany in the University of Glasgow.

Edwards's Botanical Register; each monthly Number containing eight plates; 4s. coloured. Edited by John Lindley, Esq. F.R.S., Professor of Botany in the London University.

Sweet's British Flower-Garden; each monthly Number containing four plates; 3s. coloured, 2s. 3d. plain. Edited by Robert Sweet, F.L.S., author of several botanical works.

Loddiges's Botanical Cabinet; each monthly Number containing ten plates; 5s. coloured, 2s. 6d. partly coloured. Edited by Messrs. Loddiges.

Maund's Botanic Garden; each monthly Number containing one plate, bearing pictures of four plants; 1s. 6d. coloured and large paper, 1s. small paper. Edited by Benjamin Maund, Esq.

The reader will find the few abbreviations used in the following extracts explained in p. 12.

DICOTYLEDONOUS POLYPETALOUS PLANTS.

IX. *Cruciferae*.

16424 *HESPERIS*.
speciosa *Sret.* showy $\text{♀} \Delta$ or $\frac{1}{2}$ ap Ho.P Siberia 1829. S s.l.ru. Sw.fl.gar.2. s.135

A beautiful little plant, which flowered in April, 1830, at Bury Hill, where Mr. Cameron had raised it from Siberian seeds. Mr. Sweet's researches have not enabled him to identify it with any already described species. (*March.*)

XI. *Capparidææ* § *Cledmææ*. *Cledme gigantæa* is figured in the *Bot. Mag.* for March, t. 3137. Its "flowers are perhaps among the largest of the genus; but they are less conspicuous than many others, on account of their almost uniform pale green colour."

XXIX. *Tiliadææ*. "*Brownlôwia elâta* blossomed in September, 1831, in the stove at Wormleybury, and then measured $9\frac{1}{2}$ ft. in height, and the stem 10 in. round, and some of the leaves $10\frac{1}{2}$ in. in length by 8 in breadth. It is a grand tree in India, being, according to Mr. G. Don, 100 ft. in height; and, according to Roxburgh, the trunk at 4 ft. from the ground is 15 ft. in circumference. Dr. Wallich says, in the Calcutta Botanic Garden it forms at all times a beautiful spectacle, and especially when covered with its numerous grand panicles of yellow flowers: it is a stove plant in Britain. (*Bot. Reg.*, Feb. 1832, t. 1472.)

XXXII. *Ternstrômiadææ*.

2038. *CAMELLIA* 18166. Japónica.
var. *Sweetiâna* Swt. Sweet's ❸ ◻ or 10 ja Ro.Va Eng. hyb. ... I 1p Sw.fl.gar.2.s.133

"Flower bearing a strong resemblance to a beautiful variegated rose; generally very double, more spreading than that of many varieties, and elegantly marked and variegated with white blush and deep rosy red." Mr. Sweet thus speaks of his camellia, the English name assigned to which is "Sweet's painted-flowered Camellia." The present variety we believe to be one of the most splendid that has ever been raised; at any rate, it is the finest that we have seen. It is of hybrid origin; the produce of the double striped fertilised by the pompone variety: the foliage partakes most of the latter variety, but is larger; and the plant, if not seen in flower, might be mistaken for a strong-growing single one. It is another of the numerous hybrid varieties that we fertilised and raised from seed, at the nursery of the late Mr. Colvill, several years ago, but it has now flowered for the first time." This is the variety mentioned as seen at Colvill's in our last floral report, p. 24.

XLV. *Grossuladææ*.

719 *RUBES*.
5910a *inébrians* Lindl. intoxicating ❸ cu 3 ap Gsh. W. N.Am. 1827. C co Bot. reg. 1471

Received by the Horticultural Society from Messrs. Floy of New York by the name of "the intoxicating red currant." Professor Lindley presumes "its berries possess some narcotic property, although such a circumstance has been hitherto unheard of in the order. The fruit has never been produced in this country." The lobed leaves have an odour like that of the leaves of *R. floridum*. (*Feb.*)

XLVI. *Cactææ*.

1476. *PERESKIA*.
Bleò H. & Kth. Bleo ❸ ◻ or 3 ja.ap Ro Mexico 1827. C s1 Bot. reg. 1473.

A native of the hottest parts of America. It is a very handsome plant, producing beautiful rosy blossoms freely in January and the succeeding months: it will bear more water than many succulent plants. Drawn from Mr. Tate's nursery. (*Bot. Reg.*, Feb. 1832.)

XLVII. *Onagrariææ*. § 2. *Fuchsiææ*.

1188. *FUCHSIA*.
2820a *bacillâris* Lindl. rod-branched ❸ ◻ or 5 su Ro Mexico 1829. C p1 Bot. reg. 1480

"An elegant deciduous shrub, apparently more hardy than any other species that we cultivate:" this, however, remains to be proved. "It blossoms all the summer long till November, grows freely in any kind of light soil, and is propagated by cuttings as readily as other fuchsias." Is most nearly related to *F. microphýlla*, but from that quite distinct. (*Bot. Reg.*, Feb.)

Onagrariææ. § 3. *Onâgreææ*. *Cenothèra anisólôba* is figured in the *Bot. Reg.* for March, t. 1479. It is described as requiring some covering through our winters, and as increasing by seeds, which ripen readily. "It grows to

2 ft. high, forming a neat, bright green, very erect, herbaceous bush, which puts forth from its summit beautiful white blossoms of an unusually large size, that expand at the close of day, and fill the evening air with their mild fragrance."

LIV. *Melastomaceæ*.

1181. OSBECKIA 9978 nepalensis Hook.
2 albiflora Lindl. white-flwd. \square or $1\frac{1}{2}$ au W Nepal 1829. C pl Bot. reg. 1475

This white-flowered variety is a very pretty plant, and was raised by Messrs. Whitley and Co., with whom it flowered for the first time in August last. It grows freely in a mixture of peat, loam, and sand, and may be increased, without difficulty, by cuttings. (*Bot. Reg.*, Feb.)

* ARTHROSTEMMA. (*Arthron*, a joint, *stemma*, a crown; anthers jointed upon filaments.)
nitida Graham. glossy-ld. \square or $2\frac{1}{2}$ pl Pa. Li Buen. Ay. 1830. S pl Bot. mag. 3412

From seeds sent to Mr. Neill, Canonmills, in 1829, by Mr. John Tweedie, now of the Retiro, Buenos Ayres. The packet was marked in Mr. Tweedie's handwriting, "Herbaceous Melastoma, from damp woods of the Banda Oriental." The plants came up freely in 1830, but did not blossom till July, 1831, when several flowered equally well in the cold frame and in the green-house (*Graham*). Flowers collected at the extremities of the shoots; corolla pale lilac, petals distant, somewhat oval, and faintly nerved.

LX. *Protaceæ*.

- 316 GREVILLEA.
2610a Calèyi R. Br. Caley's \square or 5 ju.s Brsh. R. N.S.W 1830. C pl Bot. mag. 3133
blechnifolia Cun. MSS.

Leaves pinnate, with many alternate, linear-oblong, obtuse segments. The young foliage and young branches are beautifully tinged with red, giving the whole plant a great richness of colour. The flowers are of a brownish red, and are semilateral or secund on axillary racemes that are somewhat shorter than the leaves. Styles very long and bright red. This lovely plant is published from Kew, whither it was sent by Mr. Cunningham, in 1824, under the appropriate name of *G. blechnifolia*; but Brown, in his *First Supplement* (p. 22.), has applied to the species the name *Calèyi*, adding Mr. Cunningham's name as a synonyme, because, in Caley's herbarium, Mr. Brown had discovered a specimen of the same species gathered by Mr. Caley as early as 1805. (*Bot. Mag.*, Feb.)

LXXIII. *Rosaceæ*. § 1. *Potentilleæ*. *Potentilla laciniòsa* W. and K. is figured in the *Bot. Reg.* for March, t. 1478. A species with blossoms yellow, and sufficiently large and showy to render the plant somewhat ornamental: it is in affinity rather near *P. stipularis* L.

Cérasis sphærocérpa. This kind of cherry inhabits Jamaica, St. Domingo, and the Antilles generally. The drawing published was made in the Island of St. Vincent, and received from Mr. Guilding. It is not so beautiful in its blossoms, which are produced in axillary racemes, as our English bird-cherry; but Dr. Hooker publishes the figure because no good one has yet been published, and because of the economical merits of the species. Mr. Guilding observes, "that the bark, leaves, and kernel [the round drupe, or cherry, is blackish purple in colour, and about as large as that of the common bird-cherry] have the smell and taste of those of the peach, and are employed by the French colonists in the manufacture of noyau." In the same article, these additional remarks on plants used for flavouring noyan are also presented:—"In the preparation of noyau, probably several different vegetables are employed which contain prussic acid. A species of bindweed, *Ipomœa dissècta*, abounds in prussic acid; and to that degree, as Dr. Nicholson of Antigua informs Dr. Hooker, that 'if this medicine shall be found deserving of the high character which some physicians have bestowed on it, the *Ipomœa dissècta* may become valuable in a country where the prussic acid cannot be preserved many days in a pure state. Hence this plant is a frequent ingredient in the preparation

of noyau.'” [In one of the stoves of Messrs. Young, a plant of *Ipomœa dissécta* was shown me by Mr. Penny, Jan. 20. 1832; and its foliage, when bruised, effused powerfully and abundantly a bitter almond flavour.] “But we are naturally led to expect prussic acid in plants of the plum tribe; and Dr. Swartz assures us that the bark of the *Cérasus occidentális* of the West Indies, on account of its peculiar taste and smell, is used instead of the *Amýgdalus Pérsica*; and of the *Cérasus sphærocárpa* he says, that the kernel of its nut resembles in taste that of the bitter almond. (*Bot. Mag.*, March, t. 3141.)

LXXIV. *Pomáceæ*. *Pýrus salvifolia*, sage-leaved pear, is figured in the *Bot. Reg.* for March, t. 1482. “It is a small, inelegant tree, with short crooked branches, and grey leaves, and is gay with blossoms in the spring, and laden with greenish, hard, austere fruit, ripe in October, and the flesh of which, when it has arrived at that state of decomposition in which we eat the medlar, is sweetish, and rather pleasant.” (*Bot. Reg.*) This species, or, as it is hinted, possibly hybrid from *P. nivális*, may do well for coarse shrubberies. Increaseable by grafting.

LXXVII. *Leguminòsæ*. *Gompholòbium tomentòsum* *Lab.* is figured in the *Bot. Reg.* for Feb. t. 1474., as raised at Knight’s from Baxter’s seeds. It flowered in August last, at the age of fifteen months from the germination of the seed, and has reproduced seeds freely. Highly curious from the linear subulate pinnæ of its winged downy leaves, and in its blossoms, which are small, and produced in pairs or threes at the end of the branches; and the corolla is internally yellow, externally dark olive colour. Pod the size of a large pea. The plant is found to require a good elevated shelf in the green-house during winter; light soil, and not to be over-watered.

CVIII. *Compòsitæ*. *Dorónicum caucásicum* (*Bot. Mag.*, March, 3143.) Appears to be the first British figure of this elegant yet showy vernal flower. No mention is, however, made of the fragrance of its roots. It is very easily increased by division.

CXXIII. *Oxalidææ*.

1414. *O’XALIS*.
11932a mauritiána *B. C.* Mauritian $\text{♂} \triangleleft \text{or} \frac{1}{2}$ s.o. Pa.Ro. I. of Fr. 1810. O s.p. *Bot. cab.* 1780

A pleasing little plant, increasing freely by offsetts.

Oxalis Bowieána, or *Bôwii* as it is in *Hort. Brit.*, No. 11928., is figured in the *Bot. Cab.* for March, t. 1782, and there it is observed of this large and showy-flowered, and most desirable species: — “Its flowering stems are upwards of a foot in height, and are produced in succession for a considerable time during summer.” Rich loam and the green-house are recommended for it. The foliage of this species is large and vigorous.

CXXIV. *Tropæoleæ*. *Tropæolum peregrinum*, the hooked-spurred Indian cress, or Canary-bird flower, is figured in Sweet’s *Flower-Garden* for March, t. 134. By the remarks there presented by Mr. D. Don, we learn that *T. aduncum* of Smith in his *Tour*, of De Candolle in his *Prodromus*, and of G. Don in his *System of Botany and Gardening*, vol. i. p. 746., is not distinct from the *T. peregrinum* of Linnæus. This interesting climbing plant was blooming in a green-house in the Chelsea Botanic Garden, through the month of October last. It is remarkable for the footstalks of its leaves performing the clasping office of a tendril, as the leafstalks of other *tropæolums* do, and also those of several species of *Clématis*, and of all the species of *Atragène*, *Maurándya*, and *Lophospérmum*. The name Canary-bird flower is apposite, the expanded yellow petals with their cut margins resembling the opened wings of this bird, and the hooked spur closely simulating the head and neck. The common columbine may be cited as another ornithological flower; the larkspur another. In odour and flavour, *T. peregrinum* is described as exactly resembling the common cabbage: this is remarkable, when the common nasturtium (*T. majus*) has in its fruit and foliage a very high degree of pungent acrimony. Mr. D.

Don thus remarks on its duration:—“It is a hardy annual, but, like many other South American plants, if kept in the green-house, it will flourish for several years. In all the really perennial species of this genus, the root is tuberous.”

CLVI. *Polygonææ*. *Coccoloba uvifera*, the round-leaved sea-side grape, is figured and described in *Bot. Mag.* for Feb., t. 3130. The flowers, fruit, and description presented are from the Rev. L. Guilding, at St. Vincent; for it appears neither to have flowered nor fruited in British stoves, although introduced to them in 1690. The flowers are racemose, small, white tinged green, and fragrant. As the fruit advances to maturity, it becomes enveloped by the enlarged and fleshy perianth, and thus forms an obovate reddish purple berry, resembling a small pear. In the West Indies and warmer parts of South America, the roots of this tree, which attains a height exceeding 20 ft., penetrate into the sands of the sea-shore, and are washed by the waves: hence, in conjunction with the racemes of pulpy fruits, arises its usual English appellation, “Sea-side grape.” These fruits have a sweetish acid, and rather agreeable flavour, but are not much esteemed, though generally sold in the markets. The wood, when boiled in water, gives out a red colour: it is also employed for cabinet work.

CLXII. *Piperæææ*. *Piper Bètte* is published in *Bot. Mag.* for February, t. 3132., from drawings executed in St. Vincent, at which place the plant flourishes as well as in its native country the East Indies, where, and especially in the Malay Islands, the inhabitants have, almost from time immemorial, considered it as a necessary of life: and this not by itself, but with the use of lime and the areca nut, together constituting a masticatory employed by either sex, and at all ages. Raised in India by slips and cuttings, which are carefully planted in a rich moist soil, well enclosed and shaded, so as to be protected, in a great measure, both from sun and rain.

Piper nigrum, the common or black pepper of the shops, is figured in the *Bot. Mag.* for March, t. 3139., and from the interesting information there supplied, we have deduced the following abstract:—

The long slender stems of this shrub have their numerous joints swollen, and from these joints often emit radicles which adhere to bodies like those of ivy, or become roots striking into the ground.

This very valuable spice is a native of the hotter parts of India, where it is most extensively cultivated, and where it constitutes a highly important article of commerce. Common pepper, the fruit of this plant, is an article in general use throughout every part of the civilised world. Still, it is in Asia, where the stomach is weakened by excessive perspiration, produced by the heat of the climate, by a humid atmosphere, and by a too general addiction to vegetable diet, that it is employed as a powerful stimulant. Thus, in a medical point of view, pepper proves an excellent tonic, calculated to create appetite, and to promote digestion.

Pepper of the shops is the fruit of this plant; and it is called black pepper while it is, in the state of nature, covered by its external coat. White pepper is merely black pepper deprived of its external coat; which is effected by macerating the fruit or grains in water, until the coat swells and bursts. The fruit is then dried in the sun, and by friction and winnowing cleared of the coat. It is then of a paler colour, and constitutes white pepper; but as the husk or bark contains a powerful principle, it is evident that the white pepper loses much of its stimulating property, and is inferior to the black.

“In the cultivation of the vines of *Piper nigrum*, the pepper plant, moist situations, along the banks of rivers, are preferred, where pepper plantations, or pepper gardens as they are termed, are formed. The pepper vines are planted 6 ft. asunder every way. After lining out the ground, and marking the intersections by slight stakes, the next business is to plant the trees

that are to become props to the pepper vines. These are cuttings of *Erythrina Corallodéndron*, usually called chinkareens; put into the ground about a span deep, and sufficiently early to allow time for a shoot, arising from this cutting, to be strong enough to support the young pepper plant, when it comes to twine about it. The cuttings of the *Erythrina* are commonly 2 ft. in length, but sometimes a preference is given to the length of 6 ft., and the vine is then planted as soon as the chinkareen has taken root: the shorter cuttings are usually the more satisfactorily successful. The circumstances which render the *Erythrina* peculiarly proper for this use are, first, its readiness and quickness of growth, even after the cuttings have been kept for some time in bundles, if put into the ground with the first rains; and, next, the little thorns with which it is armed enable the vine to take a firmer hold. It is a common and useful practice to steep these bundles in water, and afterwards reject such of them as do not, in that state, show signs of vegetation."

The pepper vines come into bearing in the third or fourth year after being planted. They are reckoned to be in full bearing at the end of five or six years, and they continue so till they are fourteen years old. The labour of cleansing the vines, throwing up earth about their roots, and collecting the produce of a plantation of 46,000 plants, has been performed by sixteen workmen. Two crops of pepper berries are usually produced in one year. As soon as any of the berries or pepper-corns redden, the entire bunch is reckoned fit for gathering, the remainder being then generally full grown, although green: nor would it answer to wait for the whole to change colour, as the most mature would drop off. The crop of berries is collected in small baskets slung over the shoulder, and with the assistance of women and children conveyed to a smooth level spot of clean hard ground near the pepper garden, or the village, where the berries are spread, sometimes upon mats, to dry in the sun; but they are exposed, at the same time, to the vicissitudes of the weather, which are not much regarded, nor thought to injure them. In this situation the berries become black and shrivelled, as we see them in Europe; and, as they dry, are hand-rubbed occasionally, to separate them from the stalk of the bunch. They are then winnowed in large round shallow sieves, and put in large vessels under the cover of the houses, until the whole crop is gathered, or at least a considerable quantity, when they are conveyed, usually by water, to the European factory. (*Bot. Mag.*)

DICOTYLEDONOUS MONOPETALOUS PLANTS.

CLXX. *Ericæ* § *vèræ*.

2192 ERICA.

† *Celsiana* Roll. Cels's  or 1 my.jn Bt.Ro C. G. H. 1810. C s.p Bot. cab. 1777

"It is a delicate plant, and bears its beautiful flowers in May and June." (*Bot. Cab.*) When the *Hórtus Británnicus* was first published, it was not known to which section this species (see No. 9887.) was referable: by the figure it belongs to the third, which includes the species whose corollas are narrowed upwards, and have a spreading border.

Erica Linnæana *supérba*. In the *Bot. Cab.* for Feb. 1832, t. 1778., a heath by this name is figured, with corols tubular, villose, and white, tinted with pink. The description states:—"This was raised about 1806, and is believed to be a hybrid plant. It is, without exception, the fastest in growth of all the heaths, shooting sometimes 3 ft. or more in a single season. Its beautiful flowers are produced in summer." Increased easily by cuttings, and likes large pots. The above plant appears to differ from the *E. Linnæana* *supérba* of the *Woburn Heaths*, which Mr. G. Don has, in *Loudon's Hórt. Brit.*, No. 9477., denominated *E. Bedfordiana*.

Erica réflexa is figured in the *Bot. Cab.* for March, t. 1787., where are these remarks:—"A very elegant species . . . It flowers in summer

and autumn, commonly growing to about the height of 2 ft." — *Erica elata* is figured in the *Bot. Cab.* for March, t. 1788.; whence we learn, "It grows very freely, and rarely flowers till it has attained the height of 5 ft. or 6 ft.; which, by giving it pretty large pots, it will do at about the age of three years. The flowers are very large and splendid; they are produced during the summer months." The tubular corols seem $1\frac{1}{2}$ in. in length.

CLXXV. *Lobeliaceæ*. *Lobelia robusta*, given in our last list, a figure of which is published in the *Bot. Mag.* for March, t. 3138. The stem is very stout, which *robusta* is meant to express, and almost woody. The leaves are large, the lower ones being 6 in. in length. The flowers are disposed in a terminal raceme, which, by gradual expansion, becomes considerably long. They are large, very numerous, turned to one side, and crowded; the corolla is of a deep and dull purple. The leaves are decurrent: so, in affinity, this species may be near *L. decurrens*. This is not, however, stated in *Bot. Mag.*

CCV. *Oleaceæ*. *Olea fragrans* is figured in Loddiges's *Botanical Cabinet* for March, 1832, t. 1786. "This most odoriferous plant is cultivated in Japan, Cochin China, and China, where it is greatly esteemed; and the flowers are said to be used for scenting tea. With us it requires the greenhouse, in which it should be constantly preserved. It is increased by layers or cuttings, and flourishes in loam and peat, with a portion of vegetable earth: the flowers are produced at various seasons. When their small size is considered, the scent is astonishing; and so diffusive, that we distinctly noticed it when in bloom on the back wall of our greenhouse, at considerably more than 100 yards' distance."

"The variety of fragrance in flowers is a most wonderful proof of the power of our Almighty Creator, and of his unspeakable goodness in forming such things for our pleasure and delight. While we are partaking of these enjoyments, how much are they enhanced and multiplied if we are blessed with hearts sensible of the favour, and rising up with constant gratitude and adoring love to our most benign and most merciful Father!"

CCVII. *Primulaceæ*. *Primula Auricula*, Fletcher's *Mary Anne*, is figured in the *Botanic Garden* for March, fol. 345. According to Mr. Maund, the requisites for a superior compost are, fresh loam, which has been prepared from turf by laying it together till its grass and roots are decayed; well-rotted hot-bed manure; decayed leaves, or the vegetable powder from the inside of a hollow tree; with drift sand and bone dust." Mr. Maund reproves the use of "a multifarious medley of anomalous ingredients," but admits "that a rich, wholesome, porous soil should be used." In allusion to blood, &c., occasionally used in forming compost for auriculas, he remarks: — "It is most likely that all the properties of animal matter which can be turned to good account in the excitement of auriculas are conveniently obtained in bone dust."

CCXI. *Scrophularinæ*.

65 CALCEOLARIA.
577a *chiloensis* Lindl. Chiloe α \square or 2 α Y Chiloe 1830. C p Bot. reg. 1476

This will, probably, prove one of the most valuable species in our gardens, not only on account of its intrinsic beauty, but because of its being more hardy than others of the half-shrubby kind. Stem about 2 ft. high; leaves oblong lanceolate; inflorescence, a many-flowered axillary or terminal cyme; corolla yellow, whole-coloured, the lower inflated lip pressed close to the upper one. Drawn from Low's Clapton Nursery. (*Bot. Reg.*, Feb.)

578a Wheeleri Swt. Wheeler's $\text{Y} \Delta$ or 1 my.o P Eng. hyb. 1831. D p.1 Sw. fl. gar. 2. s. 130

Mr. G. Wheeler of Warminster raised this plant: his account of it to us was, "that it is a double hybrid, raised from the seed of a hybrid that was produced from *C. purpurea* fertilised with *C. corymbosa*; this was again fertilised by *C. purpurea*, which has brought it a stage back again." It flowers and seeds freely. Mr. Wheeler "has raised several other hand-

some hybrids from the same parent, which are very different from *C. Wheeleri*; it appears that there will soon be as many hybrids in *Calceolària*, as there are in *Geraniàcææ*. . . . The whole, or the greater part, of the herbaceous species will bear our winters in a warm border; and if a collection of them were planted together, and a flower-pot placed over each in severe frost or very wet weather, and single mats thrown over the pots, they would thrive well, and make a fine appearance in spring and summer; and in such a winter as the present has been, many would stand well without the least protection: when the weather is fine and mild, the pots and mats must be all removed, to give them light and air, and even when frosty, if the sun shines warm on them." (*Mr. Sweet.*)

Calceolària bicolor is figured in the *Botanical Cabinet* for March, t. 1783., and of it Messrs. Loddiges say:—"It is necessary to keep it in an airy greenhouse in winter." We notice this, because this pleasing species seems especially prone to die.

STEMODIA.

15989a *chilensis* *Benth.* Chilean $\approx \Delta$ or $1\frac{1}{2}$ au. B Chile 1829. D 1 p Lot. reg. 470

Appended to the picture of this species is a valuable communication by Mr. Benthani; in which, besides a detailed generic character and detailed description of the species mentioned (*S. chilensis*), he gives a synoptical view of all the species of *Stemodia* hitherto known. These are thirty; and Mr. Benthani supplies specific characters and other particulars to at least twenty of them, and indicates the sources whence he has obtained a knowledge of the existence of the remainder. Seventeen are natives of India and the contiguous isles; and the remaining thirteen of Brazil, Jamaica, and Mexico. *S. chilensis* is a hardy frame plant; increasing by suckers, which trail on the face of the soil, or by what is usually but erroneously (although so in the *Botanical Register*) denominated "creeping roots." Its angulated, downy, viscous stem, a foot or more high, bears lanceolate, serrate, downy, clammy leaves, which are disposed usually in threes, sometimes in pairs, and occasionally in fours. In the axil of the upper whorls of these are produced whorls of purple (blue lilac) funnel-shaped corollas; which, from their tubes being short, and their limbs not broad, are not extremely conspicuous. The plant, I conjecture, would show its capabilities of magnitude and ornament more fully than it has hitherto done in Britain, if planted in May in heath mould, in a shaded moist northern border; and I am led to this opinion, from the trailing suckers and general aspect of the plant at Knight's, and from a remark by Mr. Benthani, that *S. sessilis* *Benth.*, another radicans species, inhabits a marshy situation. *Stemodia chilensis* was raised in 1830, by Mr. Knight, from seeds presented to him early in the spring of the same year by Robert Bevan, Esq., banker, Bury St. Edmunds, who, very early in 1830, had received them from Mr. Thomas Bridges, collector and vender of the productions of nature, now residing at Valparaiso. With seeds of *Stemodia* he also received and presented to Mr. Knight seeds of several other plants: and from them Mr. Knight has succeeded in raising *Cephalophora glauca*; a species of *Lobelia* which, judging from its habit, is rather nearly allied to *Lobelia decurrens* of Sweet's *Flower-Garden*; a plant with somewhat of the foliage of *Eryngium*; a curious plant in *Compòsitæ*; and several others.

53. GRATIOLA.

tetragona *Hook.* square-stmd. $\approx \Delta$ pr 1 au B Buen. Ayr. 1830. D p. l Bot. mag. 3134

Agrees in habit, calyx, and corolla with *Gratiola*, but differs in having four fertile stamens. Seeds of it were received at the Glasgow Botanic Garden from Buenos Ayres, by favour of Mr. Tweedie. Cultivated in the stove, it produced its small but bright blossoms in August, 1831. (*Bot. Mag.*, Feb.)

CCXIV. *Acanthaceæ*.1725. *HARLERIA*.

lupulina Lindl. Hop-headed \blacksquare or \square or \circ au Y Mauritius 1824. C pl Bot. reg. 1483
Dicliptera spinidosa, Lod. Bot. Cab. 1244.; Hort Brit. No. 27987., p. 468.

A compact leafy shrub, very handsome, almost always in flower, and particularly remarkable for its rich deep green leaves, marked with a bright red midrib. The imbricate bracteas of the ovate spike form a head like that of the hop. Flowers fugitive, but produced in long succession. At the axil of each leaf (the leaves are all opposite) are two stiff prickly spines near an inch in length. These, Professor Lindley states, are nothing but transformations of the first leaves of an abortive bud: there are, he remarks, two buds in the axil of every leaf, of which one produces foliage, and the other is abortive of them; and from this latter the spines arise. Is easily cultivated and multiplied. (*Bot. Reg.*, Feb.)

Aphelandra cristata, a magnificent specimen of, figured in the *Bot. Reg.* for March, t. 1477. In the plant at Alton Towers, from which the figure was taken, the branches of the inflorescence were at one time densely covered with blossoms, so that the inflorescence was a compact mass of crimson, forming a tuft which measured 8 or 9 in. every way. In this state it was a most splendid object for several days; between 800 and 900 flowers contributing to its brilliancy. The plant should be grown in peat [heath mould], loam, and sand, in a high temperature, with an atmosphere well filled with moisture. (*Lindley*.) In the above place, *Aphelandra cristata* is stated to be comparatively scarce out of botanical collections: this should not be the case with a plant so beautiful, and increasable without much difficulty by cuttings. A plant of *A. cristata* was blooming in a stove at Knight's Exotic Nursery, October, 1830; and, on ceasing to flower, was succeeded in November by the plentifully produced blossoms of the equally beautifully and closely allied *Geissomèria longiflora*. The latter seems free of growth and blossom too; and the season at which both plants flower, added to their beauty, renders both exceedingly desirable.

CCXXI. *Labiatae*. *Westringia longifolia* is figured in the *Bot. Reg.* for March, t. 1481. It has narrower leaves, which are obliquely directed, and somewhat twisted occasionally, imparting to this species perfect distinctness of aspect from the old *W. rosmarinifòrmis*. The latter, I think, blossoms not while small; but *W. longifolia*, at 2 ft. high, was, from November, 1831, to the end of January, 1832, quite pretty, with its rather numerous grey blossoms, in a green-house at Knight's Exotic Nursery.

76. *SALVIA*.

657a *strictiflora* Hook. erect-flwd. \blacksquare or \square or \circ 3 d BLR Peru 1831. C lt Bot. mag. 3135

Assimilates closely to *S. biflora* R. and P., but that is described as being superlatively villous; *S. strictiflora* is glabrous every where except the corolla. It is a pretty species, with rather bright red tubular blossoms [and apparently something of the habit of *S. splendens*, but its leaves are broad and cordate]: its connectivum is remarkably long. The whole plant, on being touched, yields a strong but not agreeable scent. (*Bot. Mag.*, Feb.)

MONOCOTYLEDONOUS PLANTS.

CCXXVIII. *Amaryllidææ*.975. *HARRANTHUS*.

pumilus B. C. dwarf ♂ \triangle or ♂ au R Chile 1831. O s. 11 Bot. cab. 1771

Lately introduced. The flowers seem large in proportion to the stature of the plant, and are often followed by seeds which ripen in this country. The plant is readily multiplied by these, and also occasionally by offsets. (*Bot. Cab.*, Feb.)

993. *NARCYSsus*.

7537a *stellaris* Haw. starry-flwd. ♂ \triangle or ♂ 1 my W.c ... 1629. O eo Sw. fl. gar 2. s. 132

We have Vol. VII. p. 479. noticed the narcissinean genera of Mr. Ha-

worth, who restricts the old generic title *Narcissus* to the poets' narcissus group. Of these he describes twelve species, besides varieties. The *N. stellaris*, above, is one of the rarest of these, and was observed, in May last, in flower, in the Apothecaries' Company's garden, at Chelsea, and from specimens which then flowered there the figure published was derived.

Narcissus gracilis of our *Hort. Brit.*, No. 7563., is a species of Mr. Haworth's genus *Hélèna*, and is figured by the name of *Hélèna gracilis* by Mr. Sweet in his *Flower-Garden* for March, t. 136.

CCXXXIX. *Iridææ*.

122. SPARAXIS.

lineata Swt. red-lined ♂ \triangleleft or $\frac{1}{2}$ sp W.Pk C.G.H. ... O s.pl. Sw.fl.gar.2 s.131

Drawn from Colvill's, where several plants of this species flowered in the spring of 1831. They were neat and pretty, and appeared to flower freely. Mr. Sweet's researches have not enabled him to find a recorded description which will agree with them, and he has consequently constituted them a species, and applied to it the epithet *lineata*, in expression of a pink-coloured line or stripe, with which every segment of the whitish perianth is marked down its centre. (*Sweet's Flower-Garden*, Feb.)

CCXL. *Orchidææ*.

2532. ZYGOPE TALUM.

maxillaris B. C. jawed £ \square or 1 au V. spot. Rio Jan. 1829. D p.r.w Bot. cab. 1776

The lip is very broad, and on its disk, surrounding the column, is a fleshy production resembling the lower jaw, beset with teeth, which has suggested the name. Almost every importation from South America contains something new in this increasingly interesting family. A few years since only two or three species were in cultivation, and now they are almost innumerable; while each newly discovered kind is as diversified from every other, and as marvellous in its form, as the very first. (*Bot. Cab.*, Feb.)

CCXLI. *Scitamineæ*.

6. HEDYCHIUM.

urophyllum Wal. ? tailed-lvd. £ \square fra 5 s Y India 1829? D_r.1 Bot. cab. 1785

A showy species. The blossoms are pretty large, and the yellow ground is, according to the drawing, here and there streaked and tinted with orange.

CCXLVII. *Asphodèleæ*.

*1073a GEITONOPLESIIUM *Cun.* (*Geiton*, a neighbour, *piësiön*, near; to *Eústrephus*.) 6. 1.

cymòsum R. Br. *cyme-flwd.* £ \square cu 1 ... G N.S.W. 1825. C p.l Bot. mag. 3131

Luzuriàga cymòsa Brown in *Prod.* l. 282., and Loudon's *Hort. Brit.* No. 8966.

montàna R. Br. *mountain* £ \triangleleft or 1 ... G N. Holl. 1820. C s.p

Luzuriàga montàna Brown in *Prod.*, Loudon's *Hort. Brit.* No. 8967.

ásperum *Cun.* *rough-angled* £ \triangleleft cu N. Holl. 1831. ...

In Loudon's *Hort. Brit.* (p. 137.), two species of New Holland plants will be found referred, after Mr. Brown, to the Peruvian genus *Luzuriàga*. With this genus they do not agree, and they are now to constitute the genus named above. Mr. Cunningham, who has devised the word *Geitonoplèsium*, designs by it to express, not only the intimate affinity of the plants composing it to the genus *Eústrephus*, but also to express the fact that plants of both genera occupy the same habitat. He observes, "The greatest quantity of *Geitonoplèsium cymòsum* I have ever seen in New South Wales, where it is, comparatively speaking, a rare plant, was in the same dark shaded wood where *Eústrephus latifolius* was equally abundant, and where they were to be seen climbing up the same tree."

Geitonoplèsium differs from *Eústrephus*, the "orange vine of the colonists," in having its sepals equal and beardless; but more especially in its indehiscent fruit, which is a berry, containing sometimes but a single seed; while the fruit of *Eústrephus* (which has its three inner sepals bearded) is distinctly a three-celled, hard, baccate capsule, which, when bursted, exhibits many large black seeds.

The *G. cymosum* was found by Mr. Brown about Port Jackson, and also within the tropical parts of New Holland. The plant has been introduced to the royal garden at Kew, from New Holland, by Allan Cunningham, Esq., late colonial botanist there, who has recently returned from that country, after many years' residence, which have been wholly and most enthusiastically devoted to the natural history and geography of it; so that science cannot fail to derive great benefit from his researches. Mr. Cunningham observes *G. cymosum* to inhabit dense subhumid woods on the sea coast, in which *Corypha australis* (the *Alsophila australis*, or tree fern of the colony), *Eústrephus latifolius*, *A'chras australis*, *Trochocarpa laurina*, *Cedrela Toóna*, *Fiéldia australis*, *Cargillia australis*, and several parasitic epidendrums, with the more splendid Australian ferns and mosses, luxuriantly grow; on the belt of a mountain bounding the Illawarra, or Five Islands' District, in lat. $34\frac{1}{2}^{\circ}$, on the west, and elsewhere, in like shaded situations, on the extended shores of New South Wales.

Besides the two species of Mr. Brown, *G. cymosum* and *G. montanum*, Mr. Cunningham has discovered a third, which he has also introduced at Kew. From *G. cymosum* it differs in habit, and Mr. Cunningham distinguishes it as "*G. ásperum*; ramulis membranaceo-angulatis asperis" [branchlets membranaceously angulate and rough].

Lachenalia mutabilis. Mr. Sweet, in figuring this curious and interesting species in his *Flower-Garden* for February, has some useful suggestions for the more successful culture of this lovely spring-flowering family; they are these:—"The genus *Lachenalia* contains numerous handsome species, but a great many of them frequently disappear from the different collections: we believe this effect is chiefly owing to the bulbs being exposed to the heavy rains after flowering; and, being grown in pots, they sometimes become sodden; and as the bulbs are very succulent, and scarcely any of them covered with a dry scaly bark for protection (so different to most other bulbs), this causes them frequently to rot. The better method of treatment would be, to take them out of the ground as soon as they have lost their foliage, and keep them dry in as cool a place as possible, that they may not begin to grow too soon: by this mode of treatment they may be either planted in a warm border in spring, or in pots in a frame or green-house. We have always observed that dry imported roots from the Cape flower much finer than ever they do after." Sandy loam is the soil recommended for all the species in *London's Hort. Brit.* I have seen them grow and flower vigorously, annually potted in heath mould alone.

Succulent Plants.—The following remarks appertaining to the physiology of these plants are offered by Mr. Maund in his *Botanic Garden* for March, 1832, under description of *Sedum Aizoon*, No. 348.:—"It would appear as though many species of *Sempervivum*, *Sedum*, *Cotylèdon*, *Cactus*, and also other plants in the order *Crassulacæ*, grew independently of the grosser elements, earth and water. It is true that some of them will exist for months in the absence of both. Natives, as many of the *Cictææ* are, of the rocks of South America, they meet a scanty supply of either; and, indeed, our own *Sempervivum tectorum*, or common house-leek, attached to a cottage tiling, furnishes a familiar example of fleshy or succulent plants withstanding the effects of drought.

"This economy, wisely bestowed on such as are natives of hot countries, is effected by a peculiar formation of their skin or cuticular covering; which, as Sir J. E. Smith expresses it, constitutes 'a fine but essential barrier between life and destruction.' The cuticle of leaves is, in general, so formed as to admit of absorption and very ready exhalation; the upper surface of the leaf performing the offices of the former, and the lower surface of the latter. How frequently do we see plants, not of the succulent kind, faint under the heat of summer! But with the succulent tribe this cannot

so easily occur; for, independently of their greater quantity of fluid, their cuticle does not admit its ready evaporation: it is protected as in a bottle. But although these juices are prevented by so thin a membrane from escaping, still that same membrane easily admits the admission of moisture; a gathered leaf will remain long before it becomes flaccid and withered; but when it is in that state, if put into water, it quickly regains its wonted plumpness: which yields a clear proof of the peculiar properties of its covering, or of the internal organisation of this curious tribe."

Iris tuberosa, a Native of Ireland and England; with a successful Mode of cultivating it. — Our very valuable contributor, the Rev. W. T. Bree, shows, in a communication to the *Mag. Nat. Hist.*, vol. iv. p. 28., that this plant (fig. 41.) grows wild in two situations in the neighbourhood of Cork, one

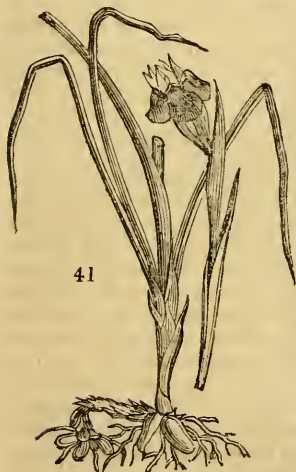

of which is a dry old hedge bank, at about the distance of a quarter of an hour's walk from that city. He likewise remarks, that in his own garden this plant blossoms but rarely, irregularly, and, on the whole, unsatisfactorily. As this case may be comparatively general, I hope to be forgiven citing here the remarks I have elsewhere presented. To blossom *Iris tuberosa* satisfactorily, do thus: — "Let it stand two or three years in succession in the same spot; then, and oftener if you wish to increase it, dig up its tubers as soon as its leaves, by turning yellow, indicate its growth finished for the season: this will be usually in July. Divide the tubers all you please, for even small fragments of these will produce plants; but just in proportion to the smallness of the divided portions will be the time occupied in their acquiring a sufficient vigour to produce blossoms. The tubers are shrivelled and weakened by being dried, being very

far less patient of drying than bulbs of crocus, tulip, and hyacinth. Divide them, therefore, as soon as dug up, and replant them immediately 6 in. deep, in a compost formed of half friable loam, and half leaf mould, or old hot-bed dung rotted to the consistence of soil. Let the situation be a dry bed or border at the base of a wall, with a southern aspect, and plant the tubers close to the wall, or only at a few inches from it. Thus treated, *Iris tuberosa*, in the Botanic Garden at Bury St. Edmunds, every spring exhibits its peculiarly coloured and constructed and delicately fragrant flowers, and occasionally also produces seeds: these, if sown the moment they are ripe, produce plants which flower in the fourth year of their age. One observance in the cultivation of this plant should be absolute; never to stir the soil within a foot of it, after the 1st of September; for it will by this time have commenced the emission of roots for the imbibition of the requisite energies for its next year's flowering, although it may not send its foliage above ground to tell you so until even November. This last remark applies to most, perhaps all, hardy bulbous plants, and to many hardy tuberous plants. The figure presented above is admirable in its general outline, but does not portray the peculiar four-edged character of the foliage; and the plant has, I believe, never such a scaly creeping sucker at its root as is there represented. Plants are now growing in the Botanic Garden, Cambridge, raised from tubers found in some wild situation near Plymouth. The propriety of considering *Iris tuberosa* a British plant seems therefore now quite established. — *J. D.*

MISCELLANEOUS INTELLIGENCE.

ART. I. *General Notices.*

MR. PERKINS'S Mode of heating by Hot Water.— This is one of the most extraordinary improvements that have yet been made in heating by this fluid. The advantages which are expected to result from it are, great economy in the first erection, as there is no boiler, and the pipes in which the water is circulated are not thicker than a man's thumb; a power of conveying heat to a greater distance than by any mode hitherto in use; of producing a much higher temperature than has hitherto been done by either water or steam, even to the extent of 400° or 500°; lastly, a more universal applicability of hot water as a medium for conveying heat. The words of Mr. Perkins's patent are:—“The object of my improvements is to obtain considerably higher degrees of temperature to the water circulated; and thus I am enabled to apply my apparatus to a variety of purposes which require the heating medium to be at a degree of temperature higher than that of boiling water. And my improvements consist in circulating water in tubes or pipes which are closed in all parts, allowing a sufficient space for the expansion of the water contained within the apparatus, by which means the water will at all times be kept in contact with the metal, however high the degree of heat such apparatus may be submitted to, and yet, at the same time, there will be no danger of bursting the apparatus, in consequence of the water having sufficient space to expand.” (*Rep. of Patent Inventions*, vol. xiii. p. 130.) Mr. Perkins has employed his mode of heating in the Bank of England, in his own manufactory in Fleet Street, in some other houses and manufactories in London, in the elephant-house at the Zoological Gardens in the Regent's Park, and in a range of hot-houses at Mr. Palmer's, Parson's Green, Fulham. We have seen the apparatus at work, both in the Zoological Gardens, and at Mr. Palmer's; and we are so highly satisfied with the plan, that we shall have our small hot-house and green-house heated by it before this Magazine sees the light. It was our intention to employ Witty's smoke-consuming furnace, to heat water, which we intended to circulate by the siphon mode; but Perkins's method will not cost above a third of the expense which this would have led us into; and, what is an object in all small green-houses, it occupies very little room. Perkins's fireplace is also calculated to consume the greater part of the smoke; not perhaps so completely as Witty's, but still much more so than by any other mode, hitherto brought into notice, which can be applied upon a small scale. To gentlemen residing in the country, Perkins's mode of heating presents an additional advantage in point of economy; and this is, that the pipes, being small, and consequently light (in comparison with the cast-iron pipes of 4 in. or 6 in. in diameter usually employed), can be sent to any distance by coach; while, the mode of joining them being entirely mechanical, they may be put together by any person who can use a screw-wrench. But we shall have a great deal more to say on the subject in our next Number, when we shall be able to speak from personal experience. In the mean time, it may be useful to inform our readers, that Mr. Perkins has made an arrangement with Messrs. Walker and Co., of St. John's Square, Clerkenwell, for manufacturing and putting up his apparatus.—*Cond.*

Mr. Austin's Works in Artificial Stone.—Our attention has lately been directed to the many beautiful garden and architectural ornaments which are now on view at this establishment; and to an important improvement which Mr. Austin has made in the composition of his cement, by which the articles formed in it, he says, become as durable as Dumfries stone (Vol. VII. p. 529. 724.), or indeed, any stone whatever. Mr. Austin particularly excels in his designs for fountains. He has lately erected a very handsome one, supported by dolphins; and is now engaged on one, a Grecian tazza of no less than 15 ft. in diameter, supported by lions (*fig. 42.*),

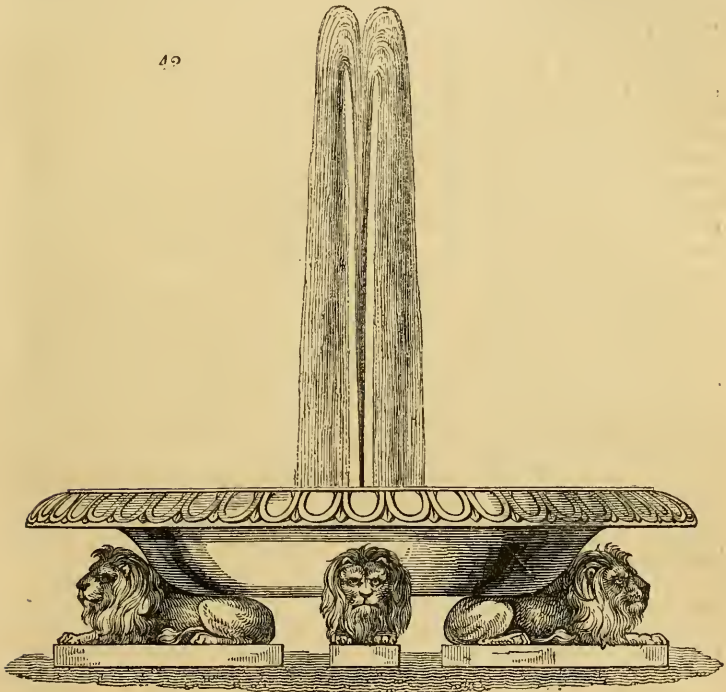

which would form a noble ornament on a lawn in front of a house. Mr. Austin's flower-stands and mignonette boxes are excellent articles, and ought to come into general use in balconies; but what we admire most is the almost innumerable variety of his ornamental chimney tops and pots, for cottages of every description, and for Gothic or old English villas. Nothing is more wanted in our rural architecture, than to remove the commonplace appearance of chimney tops. One of the great errors of omission in builders lies in not displaying these characteristics of human dwellings, and one of their commonest errors of commission consists in vulgarising them. If our new *Encyclopædia of Cottage, Farm, and Villa Architecture* does not effect a great improvement in both these particulars, we shall be very much disappointed.—*Cond.*

The Cámara lúcida, the invention of the late Dr. Wollaston, and much improved by Mr. Dollond, is one of the most valuable instruments that can be used by travellers, or tourists, or indeed any persons desirous

of making perfectly correct outlines of landscapes, or any other objects whatever, who have never been taught to draw. The sketches drawn by Captain Hall in North America were made by this instrument; and the very lines, traced on the spot, were transferred to the plates; "in order," as Captain Hall observes, "to preserve, as far as possible, the character of truth which the mechanical accuracy of the camera lucida communicates to its work, even in hands but little familiar with the management of the pencil."

Varley's Graphic Telescope differs from the camera lucida in acting by reflection, whereas the camera acts by refraction. The graphic telescope is capable of being used as an ordinary telescope. Some ideas of its wonderful powers in assisting correct delineation may be formed, from the circumstance of its having been employed by Mr. Horner, in making the original sketches for the panorama of London, from the summit of the cross on the dome of St. Paul's, now exhibiting in the Colosseum.

We have thought it advisable to direct the attention of young gardeners to this instrument, and the preceding one, in order that such of them as are sent out as collecting botanists may not fail to take one with them, and make sketches of whatever they see interesting. Had a certain young man, that we could name, recently returned from South America, had one of these instruments, and made use of it, he might have sold his sketches and his notes for what would nearly have paid his expenses. We trust this hint will not be lost. — *Cond.*

Sheds for Stone-breakers. — A correspondent in the *Scotsman* suggests the humanity that would be evinced, and the advantages gained in additional labour, by movable coverings being provided for men who break stones on the roadsides. This might easily be effected either by a tent of simple construction covered with Edington's waterproof cloth, or by four frames of straw matting, three for sides, and one for a roof. (See also Vol. V. p. 678. fig. 156.) He should likewise be furnished with sabots for his feet. — *Cond.*

The Normandy Wheelbarrow. — You should strongly recommend this to market-gardeners. I send you a sketch of one which I saw in daily use for two years during my stay at Honfleur and Lisieux. There is a subscription-garden at the latter place, of which a friend of mine intends to send you some account [given p. 66.]. In the mean time, as to this barrow, it has very long handles or shafts, the advantage of which is, that, when the barrow is loaded, nearly all the weight is thrown on the axle; so that the barrow-man has almost nothing to carry. From the view of the upper side of the barrow (*fig. 43. a*), the side-view (*b*), and the given length of the shafts, any wheel-

43

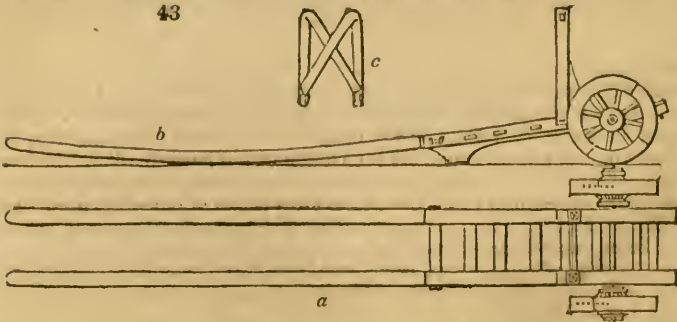

wright may be able to construct one. A shoulder-strap, of a very simple construction (*c*), is useful in saving the operator's arms. — *J. M. Lisieux,*

July, 1830. We have described a barrow of this sort in our *Encyclopædia of Agriculture*, 2d edit. p. 380.; but as the engraving there given is very small, we have deemed it advisable to introduce another here, of so very useful a machine. — *Cond.*

To poison Rats and Mice. — Mix a pound of plaster of Paris powder thoroughly with an equal quantity of oatmeal. Place this in a dry place, within reach of the rats; they will eat of it eagerly, and by the humidity contained in their stomachs, the plaster of Paris will “set,” and form an indigestible hard mass, which will occasion death. (*Col. Macerone in Mech. Mag.*, vol. xvi. p. 14.)

Furze Tops as a Manure. — “Farmers are cutting large quantities of small Irish furze for manure. It is found that furze, well trodden under the feet of cattle, and mixed with straw, or other materials of the kind, is excellent manure, especially for potatoes, as it keeps the ground open. (*Irish Agr. Report in Scotsman of Feb. 20. 1830.*)

Tar used as a Manure. — Berkeley, Bishop of Cloyne, who wrote *A Treatise on the Virtue of Tar-water*, carried his predilection for tar so far as to use it as a manure; for Bennett, one of his successors, describing the episcopal residence at Cloyne, in a letter to Dr. Parr, says, “There is a pretty winding walk of nearly a quarter of a mile long, adorned for great part of its length by a hedge of myrtles 6 ft. high, planted by Berkeley’s own hand, which had each of them a large ball of tar put to its roots: the evidence of this fact is beyond contradiction.” — *G. M. Lynn, Sept. 5. 1828.*

The Profession of a Gardener, and the natural Love of Gardening. — “On observing the pale-faced mechanic hurrying away to his morning labours, we almost regret, with Rousseau, that great cities should be so numerous; that mankind should be congregated in such mighty masses; and think, not without pain, of the many long hours the artisan must pass in the tainted atmosphere of a crowded manufactory. But how different are our feelings on seeing the gardener resuming the badge of his trade, or the ploughboy harnessing his well-trained team! The toils of both may be hard, but they are, at the same time, surrounded with every thing that is rural and inviting. The grass springs and the daisy blossoms under their feet; the sun tells them by his shadows how the day waxes or wanes; the blackbird serenades them from every hedge or tree; and they enjoy, moreover, the inexpressible pleasure of seeing Nature, in her fairest forms, rewarding most munificently their skill and industry. How does the citizen sigh for such scenes; and how soon, when his fortune is made, does he hurry away from the confines of a second Babel, to sink the merchant in the gentleman farmer! Few who are so fortunate strive to rival the handicraftsman by making their own shoes, or any other needful article of dress; but all, yes all, who are able, strive to trim their own gardens, and superintend the cultivation of their own property.” (*Dumfries and Galloway Courier, Nov. 18. 1822.*)

An American Lady Gardener. — When Lafayette called at Fredericksburg previously to his departure for Europe, in the autumn of 1784, to pay his parting respects to the mother of Washington, he found her working in the garden, clad in domestic-made clothes, and her gray head covered by a plain straw hat. The venerable matron saluted him kindly, observing, in reply to the encomiums which Lafayette had lavished upon his hero, and paternal chief: “I am not surprised at what George has done, for he was always a very good boy.” (*North American Review.*)

Botany and Planting. — A correspondent of the *Bristol Mirror* (G. C.), in speaking of Mr. Miller’s liberal plan for a botanical garden, says, in proof of the advantages of a taste for planting, accompanied with and assisted by botanical researches, “Mr. Robertson, formerly Surveyor of the Woods and Forests, has often declared to me that he knew of no surer way of

acquiring wealth *without care* than that of planting; to which he added spade labour, in digging, for seven years; and always planted so as to make the thinnings pay for the labour, till all were safe and thriving." Among other instances of successful planting, this gentleman says, "Colonel Johnes, of Hafod, was offered 100,000*l.* for woods he had planted for his amusement." (*Cambrian*, July 9. 1831.)

The Pita de Guataca, a Plant affording a valuable Fibre for Cordage, &c.—Sir, Having been applied to for information as to where an account of the plant which produces the valuable fibre known in South America by the name of the Pita de Guataca is to be found, I beg leave to send you such imperfect information as I possess upon the subject, for insertion in your Magazine, as the fitting depository of every thing rare and valuable connected with botany and horticulture.

The Pita plant, of which the only specimens in Europe, of whose existence I am aware, are those in the possession of Mr. Pontey here, and one which he exchanged with Mr. Lambert, of Boyton House, Wilts, was raised in 1827 from seeds received from His Britannic Majesty's consul, Edward Watts, Esq., at Carthagera, after a number of unsuccessful attempts; success being at last obtained by inacerating the seeds in water for a week previous to sowing. The fruit of the plant is a head of capsules formed like a small apple, and consisting of a number of capsules, shaped in a triangular form, with the apex upwards, and enclosing from four to five seeds, of a somewhat reniform shape, and mostly hollow and abortive. Each capsule is fortified by a strong coriaceous bractea, spinous at the margins, and with a sharp point at the apex; being, like the capsule, of a triangular shape. These are clustered round a central receptacle, forming what is not inaptly termed the Pita pine. From a specimen which I received in 1827 from Carthagera, with about 6 in. of the scape adhering to it, I was able to observe that the scape, which appeared to be a compact mass of fibres, produced more pines than one; evident marks remaining of a second pine having grown on the same scape, but removed, whether by accident or design, I cannot say. The flower I have never been able to procure, and my description of the pine, or fruit, is from recollection, the original specimen having been sent to Dr. Hooker, who, I fear, never received it, as he has never noticed it in his letters. I enclose, however, one of the bracteæ, which I accidentally found in the bag in which I originally received it. From the seed, however, it is evident that it can neither be a *Pourrètia*, the seeds of which are winged; a *Piteafrnia*, the seeds of which are caudate; an *Acanthóspora*, the seeds of which are caudate; a *Tillándsia*, the seeds of which are papose; a *Guzmánia*, the seeds of which are acuminate; a *Bromèlia*, the fruit of which is a berry; nor an *Ananássa*, the fruit of which is fleshy: differing, indeed, from almost the whole of these, in having a unilocular, not a trilocular, capsule. Neither do I imagine it to belong to the genera *Bilbérgia* or *Æchmæa*, both of which have berried capsules. Hence I am led to believe it belongs to some nondescript genus, whose place ought perhaps to be between *Guzmánia* (*Spreng. Linn. Gen. Plant.* ed. 9. 1830, gen. 1297.) and *Pourrètia* (gen. 1298.); and I look with anxiety to the flowering of some of our plants, which are now in their fifth year. The plant grows wild, in the greatest abundance, in the vicinity of the village of Guataca, in the province of Carthagera; where its leaves attain, as my intelligence from that quarter acquaints me, a length of from 9 ft. to 12 ft., and a thickness of from 3 in. to 4 in. These are linear lanceolate, with recurved spines along the margin, and in appearance resemble what I recollect of the *Bromèlia Pénguin* and *Bromèlia Karátas*, both plants common in the West Indies, and affording, the latter especially, a valuable fibre from their leaves; but, in point of length, the Pita exceeds them. It is from the leaves that the fibre is extracted by the barbarous

process of malleting, and occasionally separating the parenchyma by abluition with water; an operation so tedious and so laborious, that one man can barely manufacture 2 lbs. weight a day. Another defect in the process appears to me to be the late period of cutting the leaves, which are allowed to attain their full maturity; by which their fibre becomes coarser, more rigid and ligneous, and less adapted for use. Its strength, therefore (as may be seen by the table in next page), is, in its present state, inferior to both Riga and Italian hemp; but when the manufacture becomes improved, as I trust it will, now that it has been introduced at my solicitation into Jamaica, and the leaves are cut at a proper age, its strength, as well as its other properties, will, I am confident, be found superior both to flax and hemp. In point of weight, it has the advantage, being $\frac{1}{11}$ lighter; and, in point of offal, the advantage is enormous, the quantity produced from as much as made two log lines, and a pound of line twine, amounting, according to a report in my possession, only to $\frac{5}{8}$ lb.: while the same quantity of Italian hemp gave $2\frac{1}{3}$ lb., and of Riga hemp $2\frac{1}{4}$ lb.: from which data I have estimated that 3 tons' weight of Pita is capable of yielding as much cordage, sail, or other cloth, as 14 tons, 19 cwt. 11 lb. 10 oz. and 6 drs., or, in round numbers, 15 tons, of undressed hemp. The weight of two bundles of cordage, of equal lengths, of Pita and hemp weighed, the Pita 1 lb. 14 oz., the hemp 2 lbs. 1 oz., exactly $\frac{1}{11}$ more, or 3 oz. This fibre is preferred to hemp in the places where it grows, from its superior durability, and superior power of resisting the action of wet. Hence it is used for fishing-nets, cordage of all sorts, packing bales, and even shoes, being even preferred to leather. As a corroboration of this latter fact, I find, in Mr. Worsley's highly ingenious little volume, entitled *A View of the American Indians, pointing out their Origin*, published in 1828, at chap. x. p. 146., an account given of the journey of Aaron Levy, a Portuguese Jew, in South America, with an Indian guide; in which it is stated that "having travelled two days, the Indian made him put on the *canvass* (Pita?) shoes, take a staff, and follow him." Hence there can be little doubt that if its strength should be made to approximate in any degree to that of hemp, and, still more, if it should be rendered superior, as I think probable, it will be found an important acquisition both to our navy and our colonies.

Pita being unfortunately a term indiscriminately applied in South America to all fibrous plants, however distinct their genera, as *Bromèlia*, *Agave*, *Yucca*, &c., it becomes important to determine the genuine characters of the *Pita de Guataca*, which I hope will, before many years more, enable us to do this, by flowering in Pontey's stove. The plant admits of easy propagation, like the *Bromèlia*, from suckers, and ought to have a place in every collection. Regretting my inability to furnish more accurate details, I remain, Sir, yours, &c. — *W. Hamilton. Plymouth, August 5. 1831.*

P.S. I send you a specimen of the leaves and fibre, and of the cordage made from the fibre; also a specimen of one of the bractææ. A prize was awarded to Mr. Pontey at Easter, last year, for this valuable plant. — *W. H.*

The *leaf*, which was cut off one of the plants in Mr. Pontey's stove, is 2 ft. long; and, to the extremities of the short prickles, about $3\frac{1}{2}$ in. broad in its middle part, where it is widest: it is of a thin texture, and therefore renders it possible that the "thickness of three or four inches," ascribed to it in the preceding communication, is a mistake for so much in width. The *bractææ* is sufficiently described above. The *fibre* is similar to that of hemp, but harsher to the touch, and of a silvery hue. The *cord*, or log line, made from the fibre in His Majesty's dockyard at Plymouth, consists of three strands, as log lines usually do, and appears to possess all the requisites of the very best cordage. — *Cond.*

Result of the comparative Trials of Strength, &c., of the following Fibres.

Three feet in length of each employed in each experiment.	Number of experiments made with each.	Weight with which each broke expressed in Pounds Avoirdupois.		Difference of Strength, expressed in Pounds Avoirdupois, between each of the four Substances employed in the preceding Experiments, calculated from the Report of the Master Ropemaker in His Majesty's Dockyard.								Weight of Offal from Hemp dressed, Log lines 2 No. } of each Seine twine 1 lb. sort, Master Ropemaker's Rep.	
		Seine twine.	Log line.	Italian.		Riga.		Pita A.		Pita B.			lbs. decim.
				Seine twine.	Log line.	Seine twine.	Log line.	Seine twine.	Log line.	Seine twine.	Log line.		
Italian.	1	56	186			+14	-7	+24	+49	+20	+7	2.333	
	2	46	207			+14	+10	+10	+56	+21	+42		
	3	49	307			+13	+121	+13	+131	+24	+170		
	Sum	151	700			+41	+124	+47	+236	+65	+219		
	Mean	50 $\frac{1}{3}$	233 $\frac{1}{3}$			+14	+41 $\frac{1}{3}$	+15 $\frac{1}{3}$	+78 $\frac{1}{3}$	+21 $\frac{1}{3}$	+73		
Riga.	1	42	193	-14	+7			+10	+36	+6	+14	2.250	
	2	32	197	-14	-10			-4	+46	+7	+32		
	3	36	186	-13	-121				+10	+11	+49		
	Sum	110	576	-41	-124			+6	+112	+24	+95		
	Mean	36 $\frac{1}{3}$	192	-14	-41 $\frac{1}{3}$			+2	+37 $\frac{1}{3}$	+8	+31 $\frac{1}{3}$		
Pita A.	1	32	137	-24	-49	-10				-4	-42	0.625	
	2	36	151	-10	-56	+4				+14	-14		
	3	36	176	-13	-131					+11	+39		
	Sum	104	464	-47	-236	-6				+18	-17		
	Mean	34 $\frac{1}{3}$	154 $\frac{1}{3}$	-15 $\frac{1}{3}$	-78 $\frac{1}{3}$	-2				+6	-5 $\frac{1}{3}$		
Pita B.	1	36	179	-20	-7	-6	+14	+4	+42			0.625	
	2	25	165	-21	-42	-7	-32	-11	+14				
	3	25	137	-24	-170	-11	-49	-11	-39				
	Sum	86	481	-65	-219	-24	-95	-18	+17				
	Mean	28 $\frac{2}{3}$	160 $\frac{1}{3}$	-21 $\frac{1}{3}$	-73	-8	-31 $\frac{1}{3}$	-6	+5 $\frac{1}{3}$				

Weight of equal lengths of
 Riga hemp, 21 oz., or 2,000,558 lbs.
 Pita, - 14 oz., or 1,007,812 lbs.

W. HAMILTON.

Dr. Hamilton, in a previous letter, mentions also the *Pita de Tolu*. This, he observes, "grows in large quantities at Tolu, is probably a species of Agave, and yields a fibre coarser and browner than that of the Pita de Guataca, and inferior in quality. The value of the fibre of Pita de Tolu is, in Carthagena, from ten to twelve dollars for 100 lbs. Spanish; that of the Pita de Guataca, more.

We understand that a plant or two of the Pita de Guataca are now growing with Mr. Anderson, in the Apothecaries' Botanic Garden, Chelsea; they having been received there from Mr. Lambert.

Dr. Hamilton, in a letter dated Dec. 24. 1831, has sent us the following extract from a letter he had lately received from Jamaica, bearing date Sept. 3. 1831:—"The Pita plants, I am happy to inform you, are thriving. They are too few, however, and still too young (they were only introduced from Carthagena last spring by the packet Emulous) to afford a supply of the leaves for any experiments. There can be no doubt, however, that it admits of being cultivated in our dry sandy savannahs, which are at present uncultivated and unproductive. Should you observe any further information respecting the improved machine which has been proposed for the preparation of hemp, I shall feel obliged by your communicating it. There is a great number of plants in this country from which a texture of the hemp kind may be obtained, the trouble of the preparation

being the great objection." In Lindley's *Introd. Nat. Ord.*, p. 257., the following remark is quoted from Prince Maximilian's *Travels*: — "Ropes are made in Brazil of a species of *Bromèlia*, called *Grawatha*."

On the Pruning of the Oak. — Amongst the many cultivators of forest trees, some are advocates for it, and some are against it: I am of the former class. In pruning forest trees, particular regard should be had to their health and vigour, and not to their particular size or age; for it is evident that a vigorous tree, and full of sap, twenty years of age, may be pruned with more safety than a stunted one fifteen years old, because the parts cut over would heal sooner in the former one, from its being full of sap, than in the latter, which was deficient in sap: indeed, the whole art of pruning consists in thinning out the branches according to the size, health, and vigour of the tree; to have the tree as well poised with branches as circumstances will allow; and leaving those branches on the tree which will assist the general circulation of the sap. Hence the great necessity of a knowledge of physiology in pruning; and it would be well if proprietors of plantations would duly consider the subject. It would not only tend to their advantage, but would give satisfaction and pleasure to the person having charge of the plantation. I am glad to see a contemporary advocate of my opinion in *Quercus Secundus*, in Vol. III. p. 285. I shortened the roots of some hundreds of transplanted Turkey oaks two years ago, and those I have taken up have answered my expectations in making fibrous roots. I am, Sir, yours, &c. — *Quercus.* Feb. 2. 1828.

The Double Pædônia officinàlis produces Seeds. — Sir, In Vol. VII. p. 477. you allude to a remark, made by Professor Lindley in a late lecture, that the double *Pædônia officinàlis* is capable of producing seeds; in confirmation of this opinion, I beg to observe, that, in my garden, last year, a plant of *Pædônia officinàlis rubra* seeded, from which I have got three plants; the remaining seeds are still in a sound state, and I am in great hopes will yet vegetate. This year I endeavoured to effect the same object in *Pædônia officinàlis carnescens*; but I did not succeed, owing, I apprehend, to the buds having been injured by the severe frosts which we had in the beginning of May. I am, Sir, yours, &c. — *S.* London, Aug. 20. 1831.

ART. II. Domestic Notices.

ENGLAND.

THE Species of Plants which thrive in the smoky Atmosphere of London and its immediate Neighbourhood. — In Vol. VII. p. 352., in our notice of Dennis's Nursery, we remarked that a list of the plants which thrive in the smoke of London would not be without its use; and we there instanced with what perfect success *Morus nigra*, *Aucuba japónica*, guelder rose, Siberian and other lilacs, broad-leaved ivy, and *Gentiàna acaulis* thrive in such an atmosphere. To this list we are now able to quote the following additions, from the first number of the *Treatise on Planting*, published as No. xix. of the *Farmer's Series of the Library of Useful Knowledge*. At p. 19. of this number the writer remarks: — "The elasticity of the constituents of atmospheric air is so powerful, that when, from local causes, one ingredient is generated in undue proportion to the others, the most perfect analysis of the general air in the immediate neighbourhood of the spot where this circumstance happens, cannot detect any difference in the proportions of the proper constituents from that of the air of the most healthy regions. The atmosphere of a crowded city, and that of an open or moderately sheltered alpine region, afford by analysis the like number and proportion of ingredients or elements; but notwithstanding this, the influence of the air of these two situations on vegetation is very different.

There are certain plants which will not grow in the atmosphere of a crowded city, and there are others which thrive in the former, and will not continue long in that of an alpine air. Some of the following plants grow freely in the atmosphere of the crowded parts of the city of London:—

“*Plants that grow freely*:—Sycamore, elms, mulberries, ivies, Virginian creepers, vines, Oriental planes, and bulbous and tuberous rooted plants, except snowdrops. [The elder might be added to the trees.]

“*Plant that exists for only a few Years in perfect Health*:—Laburnum.

“*Plants that exist in Health only a limited Time*:—Privets, and China roses.

“Alpine plants scarcely ever produce flowers.”

Mr. Hitchen's celebrated Collection of Succulent Plants at Norwich is about to be broken up.—We are sorry to learn this fact, and should hope that some individual, or some scientific society in Norwich, will be found spirited enough not to allow so great a botanical treasure as this collection of succulents, to be carried away from them, and scattered abroad by non-residents. Besides the fine and old specimens of rare and curious species with which inspectors of this collection are familiar, numerous novelties from abroad, many of them nondescripts, have, by the well known enterprise of Mr. Hitchen, been recently added to it.—*Cond.*

Mushrooms grown by Mr. Callow.—Sir, I send you a few mushrooms, part of the produce of a bed, made after the method I have recommended in my work (see p. 213.). I flatter myself that you will find the quality of them equal to any that are grown in the neighbourhood of London. The bed from which these were gathered came into bearing about the last week in October; it has yielded an immense crop, and bids fair to last yet for a month or six weeks longer.

Cider from the French Bitter Scale. I also send two bottles of cider made, in 1829, with a sort of apples which are known in this neighbourhood by the name of French bitter scale. I am sorry that I cannot now send specimens of the fruit.

The favourite Sorts of Apples for making Cider, in Butleigh and the adjoining parishes. The Old Jersey, Royal Jersey, Horner's bitter scale, French bitter scale, Devonshire red streak, Gin apple, and Sweet pippin. I think the Horner's bitter scale would be well adapted for the climate of Scotland, as the trees never attain a large size; the branches are pendent, like those of the weeping ash, and the tree blossoms at least a month later than the other sorts, yet the fruit is ripe as early as the Jersey, and the Devonshire red streaks. I am Sir, yours, &c.—*Edward Callow. Butleigh, Jan. 27. 1832.*

The mushrooms were fine, fleshy, and equal to any we ever tasted in point of flavour. Cider we are no judge of, but that sent appeared very good, and was certainly very strong.—*Cond.*

ART. III. Retrospective Criticism.

CORRECTIONS to the preceding Number. (viz. p. 1. to 128.)—Under the notice of hybrid salpiglosses, date the genealogy of *S. Barclayana* from *S. straminea* and *S. atropurpurea*: not from *S. picta* and *S. atropurpurea*, as there stated. This correction has been since published by Mr. Sweet, whose error we had followed. Make, in consequence, the same correction in Vol. VII. p. 597. line 20. from the bottom. In line 32., also, of the last-named page, for “*Adenophora stylôsa*,” read “*Adenophora intermedia*,” this being a second error into which Mr. Sweet had been led, and which he has subsequently corrected. The synonyme “*Liparis priorchilus B. C.*,” p. 23. line 17. from the bottom, belongs not to “*Pleurothallis Lanceana*,” but to “*Micrôstylis versicolor Lindl.*” in the line above it: a shifting of the type occasioned this error. In p. 47. lines 2. and 3. for

“ton,” read “tree; and for “tons,” read “trees.” P. 89. line 9. for *Eránthis hyemális* “at Sir J. Fulbock’s,” read “at Sir J. Lubbock’s.”

Remarks on the Encyclopædia of Plants of Loudon, Lindley, and Sowerby. — At the request of Dr. Mease, I have read with great attention and pleasure the whole of this work : I consider it very valuable, embodying so much useful and practical information. In such an immense compilation of materials, it is no wonder that some errors have crept in ; and, as I am quite familiar with our North American plants, I have been particularly struck with those relating to them. I propose to notice some of them, in order that Mr. Loudon may correct them in his new editions, supplements, or journals.

This work appears to consist of three parts, by different hands : the botany by Lindley, the figures by Sowerby, and the history by Loudon. Each of these has peculiar excellence and defects. I have been delighted to see botany returning to the good old plan of wood-cuts, which I have long desired, and done also in some of my works (*Medical Flora, School of Flora, &c.*). The given figures are mostly excellent or good, but some indifferent or bad ; and, in a few instances, they do not represent the intended species. Mr. Lindley shows himself an acute botanist in his part ; but, as is too common among the practical botanists, he appears to be led partly by whim rather than principles, in his nomenclature, genera, and species. If this should be matter of mere taste, it would do ; but when justice is required towards the founders or detectors of genera and species, an adherence to priority is needful. If so many new genera or subgenera are needful in *Cryptogamia, Orchidéæ, Pelargonium, &c.*, why not in *Scabiösa, Narcissus, Erica, &c.*? He quotes Willdenow instead of Linnæus ; Pursh instead of Michaux and myself, &c. I found only one genus (*Adlumia*) of mine adopted, and another (*Lobadium*) quoted. My numerous works appear totally unknown. I am called a writer on botanical matters. I have been writing, indeed, for twenty-five years, and published fifty works or pamphlets, some of which I now present to Messrs. Loudon and Lindley, through Dr. Mease, in order that my labours may be a little better known in England.* I have already published or indicated 500 new genera, or subgenera, or species presumed new, of plants, many of which are yearly pilfered by others.

Mr. Loudon’s history of plants is excellent : I have found in it many novelties and valuable matter. If he had known my *Medical Flora of the United States*, where 600 genera are mentioned, and even their economical properties indicated, he could have added some other peculiarities.

Without further preamble, I enter upon the course of my remarks : —

1. The good genus *Centranthus* of Necker and Decandolle is called *Fèdia* ; and the *Fèdia* is called *Valerianèlla*. Is it oversight or whim ?

2. *Tritònia* of Ker is inadmissible : there are two genera of that name already ; this is the third. I have called it *Belendènia*.

3. *Oryzòpsis Mx.* is erroneous ; *Dilepÿrum Raf.*, 1808. The same with *Airòpsis, Arundinària, Portulacària, Erucària, Testudinària, Cucurbitària, &c.* : all these are inadmissible. *Arundinària* is *Miègia* of Persoon.

* The works presented are three. First, “*Medical Flora, or Manual of the Medical Botany of the United States of North America.*” 2 vols. 8vo, 500 pages ; with 100 woodcuts printed in green. Atkinson and Alexander. Philadelphia, Vol. I., 1828 ; Vol. II., 1830. — Second, “*Principes fondamentaux de Somiologie ; ou les Loix de la Nomenclature et de la Classification des Corps organisés.*” 8vo, 52 pages. Palerme, aux dépens de l’Auteur, 1814. — Third, “*Précis des Découvertes Somiologiques, ou Zoologiques et Botaniques.*” Palerme, aux dépens de l’Auteur, 1814. The last work represents that the author had, as early as 1814, discovered and described 190 species of animals and plants. Of these three works, we have made some mention in the *Magazine of Natural History*, vol. v. p. 76.

4. *Imperàta*: the etymon is stated to be unknown. The genus was dedicated by Cyrillo to Imperati, an Italian botanist.

5. *Cissus quinquefòlia* and *Ampelòpsis quinquefòlia*, mentioned twice under these two names: and it is neither, but my *Quinària*. See my *Monograph on Vines*, and my *Medical Flora*, vol. ii. p. 120—180.

6. *Nicotiàna*. Etymon of Tobacco: it is the name of pipe in Hayti language; and not from Tobago nor Tobasco. See *Anglina*, 1525; and my *Medical Flora*, 1830.

7. *Ipomœa Quámoclit*. False etymon given. *Quámoclit* is the Mexican name; it grows from Florida to Mexico.

8. *Gymnœma*. "Vaccine ichor," for "milk or vaccine liquor."

9. *Bêta*, a substitute for coffee. Sugar ought to be said instead.

10. *Rhús aromáticum* I called *Turpínia*; but I changed it to *Lobàdium*, on finding another genus *Turpínia*. I did not know it was called *Schmáltzia* (after me or my mother's name) by Desvauz. It is also *Myrica trifoliata* of Linnæus.

11. *Narcíssus*, "from *narke*." Ovid and all other authors derive *Narcíssus* from the name of a man.

12. *Drósera filifórmis Raf.*, 1808. Pursh, in 1814, stole this plant from me.

13. *Smilacina*. Bad name. It forms my genera *Clintònia* and *Styrándra*. The *Draœna boreàlis* of Aiton is the type of my beautiful genus *Clintònia* (dedicated to Governor Clinton, philosopher, naturalist, and statesman), with bilocular berries. I have found six species of it: those cultivated in England are *C. multiflora* and *nutans*.

14. *Polygónatum*, same as *Polýgonum*. My *Sigillària* or *Axillària*.

15. *Virgília lútea*, so called from the yellow wood. You say it has yellow flowers. Michaux's figure has white flowers; and so had the species I saw in bloom. Is a yellow-flowered species cultivated in England? The *virgíliæ* of North America and Mexico form my new genus *Cladrás-tis*; very different from the *Virgíliæ* of Africa.

16. Why is *Cydònia* adopted, while *Sórbus* and *Málus* are united to *Pýrus*; nay, also, *Arònia* united, far more removed?

17. *Spirœa corymbòsa* of Loddiges is mine; published by me in 1814. See *Précis des Découvertes*, No. 115.

18. *Actœa racemòsa* and *Cimicífuga serpentària*, twice mentioned in two places. It is my new genus *Bótrophis*, 1828; *Macròtys*, 1808.

19. *Asímína*, stated to have no meaning. Wrong: name of Indians of Louisiana.

20. *Dionœa*, *Jeffersònia*, *Podophýllum*, &c., stated to be genera with solitary species. Wrong: I have seen and described three species of each, *Dionœa corymbòsa*, sessiliflora, and uniflora; *Jeffersònia Bartòni*, odorata, and lobata; *Podophýllum peltatum*, montanum, and *callicárpum*. See *Medical Flora*, &c.

21. *Erucària*, same as *Erùca*. It is my *Pachila*.

22. *Adlùmia*. A false etymon given. It was dedicated by me to Adlum, an American cultivator and writer on vines, a friend of horticulture and botany; yet living, and making good American wine.

23. *Caméllia*, *Camelina*, and *Camelus* among quadrupeds; three genera of the same name nearly. I have called the tea shrub *Theaphýlla* (meaning divine leaf): a good name, whether a peculiar genus, or *Caméllia* to be united to it.

24. *Lupinúster*. Horrible name! *Lupinus* and *Úster*. My *Dactiphýllum*, 1817.

25. *Hypéricum virgínicum*, with "yellow flowers." Wrong: always purplish. It is my *Triadènum purpurascens*, 1808; different from *Elodœa*.

26. *Marshállia*. Marshall was an American botanist, not an Englishman.

27. *Cacàlia*. All the American species of this genus are different from

the African ones; they form my genus *Mesadènia*; five florets round a central gland: but *Cacàlia suavèolens* and *renifórmis* constitute another genus, *Synósma Raf.*

28. *Rudbécchia purpúrea*. The description and figure different. The fact is, ten species are blended under that name, and form a peculiar genus, which I call *Helicròda*; others call it *Rafinesquà*. [Mœnch has denominated this genus *Echinàcea*, from the hedgehog-like appearance of the paleæ; but whether his genus be earlier or later than those cited by Professor Rafinesque, I must leave to others to determine. — *J. D.*]

29. *E'ria*. Bad name: root of *Eriánthus*, and ten other genera. Would not *Erioxántha*, meaning yellow wool, be better?

30. *Micróstylis Pursh*, 1815. I called it *Achroánthes*, 1808. The *Líparis* of Lindley is my *Anístylis*, 1825.

31. *Aristolòchia*. This genus is a large tribe of plants: I have established in it the genera or subgenera *Glóssula*, *Pistolòchia*, *Endódeca*, *Siphídia* or *Níphus*, *Einomeia*, *Dictyánthes* (*A. labiòsa*), and others. Three or four species are blended under *A. serpentària*. Your description and figure are two different plants. The figure has large broad cordate leaves; and very different from our common kind, with oblong leaves. See my *Medical Flora*.

32. *Búsus*. We import boxwood into, and do not export it from, America. You mean Armenia in Asia: misprinted America.

33. *Maclúra Nuttal*, 1818. My *Tóxylon* (bow-wood), 1817: a previous and better name. We have two other genera of *Maclúra* in zoology and mineralogy. The fruit is not esculent. Kunth and Torrey have committed the absurdity to deem this tree the *Mòrus tinctoria*, which has oblong edible fruits, *Ayac*, in Louisiana.

34. *Cocos*. Etymon wrong: comes from *Coco*, palm trees, in the Haytian language. Introduced by Columbus in 1494: see *Acosta*. Having restored the Haytian language, by collecting 300 words from early travellers, for my *History of American Nations*, I have found many etymons; I shall mention a few: — *Yam*, from *Niames*; *Potatoes*, *Batatas*; *Manioc*, *Juco*; *Mangrove*, *Mangle*; *Ceiba* or cotton tree, *Ceiba*; *Guava*, *Guayava*; *Pimento*, *Pimento*; *Guaiacum*, *Guayac*; *Mancenilla*, *Manzínila*; *Cassava*, *Cazabi*; *Mahogany*, *Mahy*, *Cacao*, *Copal*, *Mani*; and many more.

35. Two genera, *Béllis L.*, and *Bèlis Salisbury*. This last my *Jaculària*.

36. *Abies* and *Làrix*. Why *Salisbury* quoted instead of *Tournefort*, 1700; or *Adanson*, 1750; or *Jussieu*, 1789?

37. *Gymnócladus*. Our [Kentucky] coffee tree, 80 ft. high in the west; quite straight; seeds used for coffee. This fine tree called a tree, a shrub, and a vine at once.

38. *Juníperus virginiana*. The figure has large round berries; ours has small ovoid warty berries. The figure of *J. bermudiàna* more like ours.

39. *Veràtrum virgínicum* is *Melánthium virgínicum*, by description and figure.

40. The asters of North America are a chaos as yet. We have 100 species: you have increased the confusion. Your *Erígeron carolinianum* is certainly an *A'ster* by figure, with few rays. *A. Tradescánti* is different from ours. *A'ster argophýllus*, three rays in description; five rays in figure. I have prepared a work on this genus for *Decandolle*, divided into many subgenera by simple or double rays, entire or toothed, seeds smooth or villose, &c. [Mr. D. Don has already grouped *A'ster argophýllus* and the closely related species into a genus named *Haxtònia*. See p. 19. for etymon and species. — *J. D.*]

41. *Solidàgo*. The species of North America are in the same confusion as those of *A'ster*. The figures of your *S. bicolor*, *odòra*, *mexicana*, *flexicaulis*, do not correspond with the description, nor with our species. *S. flexicaú-*

lis is our *S. latifolia*. I am preparing also a work on this genus, by seeds smooth or hairy, rays few or many, &c.

42. *Negúndium americanum* Decandolle is my *Negúndium* (1808) *fraxí-neum*. We have a second species in the west.

43. *Nýssa*. All called shrubs: they are all trees with us.

44. *Cucurbitària*, name too like *Cucúrbita*. It is my *Phialóspara*.

45. My genus *Phórima*, 1814, for *Bolétus*, with irregular cells, omitted; and many other genera of my pamphlet, 1814. [*Précis des Découvertes Somnologiques*, &c.]

46. *Piper*. "None out of tropics." Wrong: a species, *P. leptostà-chyum*, found in Florida, lat. 28°, by Mr. Ware; described by Nuttall.

47. I have discovered and described thirty-four species of *Tríllium* (see my *Medical Flora*); also

48. 30 species and 100 varieties of native North American-grapes, in my *Medical Flora* and my monograph of our American vines.

49. Many of our American botanical authors appear unknown to you. Elliott's *Flora of Southern States*, Torrey's *Flora of Northern States*, Bigelow's *Flora Bostoniënsis*, Eaton's *Manual of American Botany*, my *Flora of Louisiana*, 1817; and many more.

50. At the conclusion of the work, nine genera are stated as not reducible to natural orders. I have long investigated this subject, being a follower of natural orders, and never could find yet a genus that I could not refer to them; because, whenever a genus cannot be united to others, it must form the type of a family by itself. Thus, you have many orders in the book with only one genus: these nine could have been used so just as well. Indeed, Decandolle has made an order of *Ceratophýllum*. I could state the affinities of all those mentioned, and the many errors in joining genera to wrong orders, but this would lead too far. I merely invite your attention to my article *Unisèma* in *Medical Flora*, whereby you will see that a single species (*Pontedèria cordata* of Linnæus) may happen to be the type of not only a new genus, but a new family and new order, when the seed and fruit are totally different from the genus to which the plant is wrongly referred by the copyists of errors. Botany will never be permanently fixed until all errors are exploded and corrected. I am, Sir, yours, &c.—*C. S. Rafinesque, Professor of Botany and Natural History, &c. Philadelphia, Jan., 1831.*

Our very best thanks are due to Professor Rafinesque for the above most valuable corrections, additions, and suggestions. — *Cond.*

Mr. Howden's Reply to Mr. Small (Vol. VIII. p. 85.); with *Remarks on the Method of training Vines at Doneraile*. — Sir, I observe that a correspondent, yeapt Thomas Small, near the Church, Bexley, Kent (p. 85.), has indulged his Irish wit, by giving me a rap with his shillela. He hints that my services at Doneraile gave but indifferent satisfaction, and that "the cottage allowed me was probably as good as I deserved" Very good logic this, at least very good Irish logic; observe its counterpart: when Thomas Small worked journeyman gardener at Doneraile, in 1813, his services gave but very indifferent satisfaction, and the tenth part of a two pound note, per week, was probably as much as he deserved. Shame, shame on such wages! From the same logic it may be inferred that I richly deserve the superb cottage which I now occupy, with all its internal blessings; but this, I think, would be the height of presumption, as I should never have thought of building such a grand one for myself: but as it is an appendage to a mansion residence, I feel highly honoured in the occupation of it. I never meant to insult the Irish peasantry; I should be sorry to insult the Hottentot in his hut: but I shall always endeavour to make the Irish aristocracy ashamed of themselves. I have nothing to say disrespectful to the *present* Lord Doneraile: according to Mr. Haycroft's account he gives the average wages of Ireland or England; viz. 5s.

per week, a free house, and turf fuel, with as much potato ground as can be spared, at a light rent, or what they can find dung for. I repeat, that I have nothing to say against the present Lord Doneraile; I merely wish to expose the system prevalent in Ireland, of feeding good Catholic Christians on pigmeat, as being unlawful and unconstitutional. I had once nearly ruined two teams of horses, by feeding them on pigmeat; it is true the horses became as fat as pigs, but, at the same time, they became no more fit for hard work than pigs. The system has also the tendency of inundating the English gardens with Irish labourers; thereby lowering the price of labour, till the Englishman is reduced to live on potatoes, the same as the Irishman. It is very natural, it is very laudable, for every man to endeavour to mend his situation in life; but it is very hard, and very humiliating, to come down in the world. When Lord Doneraile's men come over to England they mend their wages 50 per cent, if they get but three half-crowns per week instead of two half-crowns; but the Englishman finds that his income has diminished in a similar ratio. His 15*s.* per week is reduced to 10*s.*, and he has only the consolation of knowing that he has half a crown per week more than the Irishman. I am no advocate for keeping up the price of labour, where machinery can be employed to better advantage; but there are very few things in gardening in which machinery can be employed to advantage. The training of peach trees, or the striking of young heaths, for instance, can never be done by machinery; and I may add, that they cannot be done by the common Irish labourer. Just such common labourers were all I had at Doneraile, and a Thomas Small among the rest. Should your correspondent, Thomas Small, near the Church, Bexley, be the same Thomas Small, I congratulate him on having, as the song says,

“Tipp'd the captain six thirteens, to ferry him over to Parkgate.”

I am also happy that he lives near the church, as he was a good Protestant; the only Protestant I had of all the ten men. The Protestants in Ireland are, however, but very little better than the Catholics; they have nearly as many superstitious notions, though of a different kind from those of the Catholics. They are, however, proud of their superiority, and despise their Catholic brethren; ay, and oppress them too most shamefully. I might give you a long description of the Irish customs and manners, but it would not suit the Gardener's Magazine; suffice it to say, that, from Mr. Haycroft's letter, a member of the House of Lords, at this moment, pays his gardeners with 5*s.* per week. If this be the maximum for all Ireland, what must be the minimum? Mr. Haycroft says, in a former letter, that many of his young men have gone over to England, and probably brought over his new system of training vines. I can only say, that the system was practised by Mr. Stuart, at Blackheath, thirty years ago; and that several of Mr. Stuart's pupils have been head-gardeners to Lord Doneraile, so that the system was as likely to be carried to Doneraile as brought from it. I would strongly recommend the horizontal system of training vines, in preference to taking them either directly or indirectly up the rafter. By the horizontal system, each vine enjoys its own element; thus:—Hot-house grapes may be trained across the upper part of the roof; greenhouse or vinery grapes, along the middle part; and hot or open wall grapes along the lower part. Yours, &c.—*John Howden. February 26. 1832.*

ART. IV. *Metropolitan Nurseries.*

THE Mile End Nursery.—This long established nursery, which was at one period considered among the first in London, is now likely to be disposed of. Our readers will observe in our Obituary the death of its late

proprietor; and Mr. Thomson's son and successor, being in a very bad state of health, we believe he intends shortly to retire from business. We have before directed attention to the fine old specimens of interesting trees and shrubs contained in this garden, and we have lately applied to Mr. Thomson for a list of their names and dimensions, which we subjoin. We have done this, because we were anxious to record them in our pages; lest, in case of the nursery not being disposed of as such, the ground on which they stand should be let for building, &c., and the stock sold, and dispersed throughout the country:—

Magnoliaceæ. *Magnolia Thomsoniana*; height, 16 ft.; and circumference, at the extremity of the branches, 28 ft. — *M. glauca*; height, 18 ft.; and circumference, at the extremity of the branches, 30 ft. — *M. glauca semper-virens*; height, 17 ft.; and circumference, at the tip of the branches, 27 ft. — *M. acuminata*; height, 26 ft.; girth, at 6 ft. from the ground, 1 ft. 11 in. — *M. tripétala*; height, 20 ft.; girth, at 1 ft. from the ground, 1 ft. 4 in. — *M. conspícua*; height, 9 ft. — *M. auriculata*; height, 12 ft.

Laúrinea. *Laúrus Sássafras*; height, 21 ft.; girth, at 1 ft. from the ground, 2 ft. 7 in.; at 6 ft., 2 ft. 2 in.

Ternströmiaceæ. *Thèa viridis*; height, 7 ft.; circumference, at the extremity of the branches, 20 ft.

Pomàceæ. *Pýrus spectábilis*; height, 22 ft.

Leguminòsæ. *Sophòra japónica*; height, 35 ft.; girth, at 1 ft. from the ground, 5 ft. 7 in.; at 8 ft., 3 ft. 11 in.; at 16 ft., 3 ft. — *Gymnócladus canadénsis*; height, 31 ft.; girth, at 1 ft. from the ground, 3 ft.; at 6 ft., 2 ft. 3½ in.; at 12 ft., 2 ft. 2 in. — *Gledítschia hórrida*; height, 38 ft.; girth, at 1 ft. from the ground, 5 ft.; at 10 ft., 4 ft. 2 in.; at 20 ft., 3 ft. 6 in. — *Virgília lítea*; height, 18 ft.; girth, at 6 ft. from the ground, 11 in.

Professor Rafinesque has well remarked (see p. 246. of the present Number) that the *Virgília* of America is botanically distinct from the *virgiliæ* of the Cape of Good Hope.

Cupulíferæ. *Leucombe's oak (Quérens Lencombeana)*; height, 45 ft.; girth, at 3 ft. from the ground, 5 ft. 6 in.; at 10 ft., 4 ft. 3 in.; at 20 ft., 3 ft. 3 in.

Willow-leaved Oak (*Q. Phellos?*); height, 34 ft.; girth, at 1 ft. from the ground, 4 ft. 2 in.; at 8 ft., 3 ft. 6 in.; at 17 ft., 2 ft. 6 in.

Cork-tree Oak (*Q. Súber*); height, 28 ft.; girth, at 1 ft. from the ground, 4 ft. 4 in.; at 6 ft., 3 ft. 11 in.; at 12 ft., 3 ft.

Purple-leaved Beech (*Fágy sylvática* 2. *àtro-rubens*); height, 35 ft.; girth, at 1 ft. from the ground, 6 ft.; at 10 ft., 5 ft. 10 in.; the circumference at the extremity of the branches is 135 ft. — *Córylus Colérna*; height, 15 ft.

Platúneæ. *Liquidámbar styracéflua*; height, 27 ft.; girth, at 1 ft. from the ground, 2 ft. 8 in.; at 6 ft., 2 ft. 5 in.; at 12 ft., 1 ft. 7½ in.

Liquidámbar imbérbe; height, 15 ft. 6 in.; girth, at 5 ft. from the ground, 1 ft. 8 in.

Hippocástaneæ. *Aÿsculus discolor*; height, 20 ft.

Terebinthàceæ. *Ailántus glandulòsa*; height, 36 ft.; girth, at 1 ft. from the ground, 5 ft. 7 in.; at 6 ft., 4 ft. 2 in.; at 12 ft., 4 ft.

Ericcæ. Scarlet *Arbutus (Arbutus Uredo* 2. *rubra*); height, 14 ft.; circumference, at the extremity of the branches, 45 ft.

Loránthæ? *Aheuba japónica*; height, 8 ft.; circumference, at the end of the branches, 27 ft.

Ilicíneæ. Dahoon holly (*Ilex Dahoon*); height, 20 ft.; circumference, at the extremity of the branches, 38 ft. — Smooth-leaved holly (*Ilex Aquifolium* var. probably); one tree is 45 ft. in circumference at the extremity of the branches, and forms from the ground a beautiful pyramidal tree, 27 ft. in height.

Bigoniàceæ. *Catálpa syringæfólia*; height, 35 ft.; girth, at 1 ft. from the ground, 6 ft. 10 in.; at 8 ft., 5 ft. 7 in.; at 16 ft., 4 ft. 2 in.

Coniferæ. *Pinus Cembra*; height, 14 ft. — Hemlock spruce fir (*Abies canadensis*), 14 ft. high.

We have recommended Mr. Thomson to offer all the above trees, and a number of others of the same sort, but of less size, at very reduced prices. The soil of the Mile End Nursery is particularly favourable for the removal of trees of a large size; and gentlemen in the neighbourhood of London have now an opportunity of placing on their lawns objects of beauty and interest, such as they may probably never have again. We hope, both for Mr. Thomson's sake and theirs, that they will not let it be lost. — *Cond.*

ART. V. *Provincial Nurseries.*

HOLTON Nursery, near Halesworth, Suffolk. — This pretty little nursery, so well situated for the accommodation of the neighbouring gentry, is just reviving, and rising into notice, and, for a country nursery, is likely to be not a little worthy of patronage. We say this in confidence of the pecuniary spiritedness and the industry of one of its proprietors, joined to the same qualities in the other; who, moreover, possesses high professional ability. Messrs. Rednall and Bircham are now the equal partners in this nursery, which, till lately, under other hands, exhibited but an irregular, ill-managed, and imperfect croppage of principally forest trees. Much of the ground has been recently cleared and trenched, and laid out anew. Heath mould is very conveniently attainable in the neighbourhood, and as American shrubs and plants are greatly in request thereabouts, it is the intention of the proprietors to cultivate these rather extensively: they find them grow freely and finely with them. Fruit tree culture will be here a prominent object of attention; Mr. Bircham, we know, has had the first of experience in this department, and is no stranger to any of the best varieties; and we have, in consequence, no doubt that he will render the Holton Nursery famous for the supplying of these, which will be an immense advantage to that corner of the country. Standard roses are also to be objects of great attention. A choice assortment of georginas is already in cultivation there, and the blaze of blossom last autumn was most superb: these were inspected by those profound judges of georgina excellence, Messrs. Chandler, Buchanan, and Rivers, who unanimously declared the blooming of them excelled any they, in their extensive circuit of inspection, had elsewhere witnessed; except only the far-famed collection of Mr. Widnall of Grantchester, near Cambridge. The new borders at Holton Nursery are now ready for as many of the choice and the newer ornamental herbaceous plants as the proprietors can procure. This attention to flowers, on their part, has already excited the admiration and proportionate patronage of the ladies in the neighbourhood, accompanied also by an encouraging degree of that of the gentlemen and noblemen residing in the vicinity. The skill, emulation, and industry of Messrs. Rednall and Bircham must insure success. — *J. D.*

ART. VI. *Provincial Horticultural Societies.*

THE season for exhibitions of show flowers is scarcely yet arrived; but we are glad to find from the papers sent to us, containing lists of prizes to be contended for at the exhibitions for 1832, rules for new societies, &c., that our provincial horticultural and botanical friends are preparing vigorously for the ensuing campaign. England, Scotland, and Ireland seem

entering warmly into this amicable rivalry; and we have no doubt of their united efforts producing the most beneficial effects. It gives us great pleasure to find the number of cottagers' prizes increasing. — *J. W. L. for Cond.*

ENGLAND AND WALES.

Newcastle Botanical and Horticultural Society. — Feb. 3. Mr. Moderill, gardener to J. C. Anderson, Esq., Point Pleasant, received a prize for the best exotic plant in flower, *Camellia japonica Chandleri*. A fine double white camellia was exhibited gratuitously by the same gardener; as was *Richardia aethiopica*, by Mr. William Laing, from the garden of N. Grace, Esq.; and a dish of uncommonly large Ribston pippins, by Mr. Robert Telford, gardener to George Hartley, Esq., Middleton Lodge, Yorkshire.

The Glamorgan and Mounmouth Horticultural Society voted the silver medal, sent down by the London Horticultural Society, to Mr. Laidlaw, gardener to John Moggridge, Esq., at Gabalva.

SCOTLAND.

Caledonian Horticultural Society. — March 1. Medals were adjudged, for the best new hardy plants in flower, to Mr. Alexander Forrester, gardener to David Falconar, Esq., of Carlowrie, for *Galánthus plicatus*, *Dáphne Dauph'nú*, and two *Narcíssi*, *A'jar pumilus* and *A'jar nanus*; and for the best six hyacinths, of different colours or varieties (Howard, Nimrod, Pourpre Suprême, Heracles, Vainqueur, and Canning), cultivated in hypnum moss, without earth, to Dr. Adolphus Ross, Abercromby Place.

The Society has the merit of bringing into notice this method of flowering hyacinths in hypnum moss; which is remarkable for its elegance and cleanliness, and for producing stronger flowers than are obtained by using the common water glasses. Three new camellias (*Anemoneflora álba*, Gray's Invincible, and *Camellia Rawèsii*) were sent from the conservatory of Professor Dunbar, at Rose Park. A splendid and lofty pyramidal Cape heath, *Erica linnæoides*, sent by Mr. M'Nab from the Royal Botanic Garden. Two very large plants of *Azalea ledifolia*, covered with a profusion of white blossoms, from the garden of the secretary, Mr. Neill, at Canonmills. *Genista canariensis*, *Iris susiana*, and early Van Thol tulips (*Tulipa suaveolens*), from the garden of Colonel Wauchope, at Emonstone. *Blétia Tankervilleæ*, sent from the Society's experimental garden by Mr. Barnet. A side-table exhibited specimens of the Bassano and Neapolitan turnip-rooted beet; and also red and white kohlrabi; all of which were the produce of the Society's garden. The Society's silver medal was voted to Mr. John Wilkie, gardener to J. A. Wardrop, Esq., of Dalmarnock, for his well conducted experiments on the subject of employing the fruit of *Astrágalus hæticus*, or Portuguese vetch, as a substitute for coffee. The astragalus was stated to be nearly on a par with succory root, but required an addition of genuine coffee to give it the requisite aroma. (*Edinburgh Advertiser*, March 3.)

IRELAND.

Belfast Horticultural Society. — Jan. By the Annual Report, this Society appears to be in a very flourishing state; and praise was particularly bestowed on John Montgomery, Esq., for his auriculas, and for having raised the first Irish seedling georgina.

ART. VII. London Horticultural Society and Garden.

JAN. 17, 1832. — *Read.* A note on the Cannon Hall Muscat grape; by J. Lindley, Esq. F.R.S. &c. The meteorological journal kept in the Society's Garden.

Exhibited. Charlsworth Tokay grapes, from Mr. R. Buck of Blackheath. Seven sorts of apples, from Mr. Joseph Kirke, and wood and leaves of the Flat peach of China, from the same. Specimens of the Swedish turnips, from Mr. G. Mills.

Also, from the Garden of the Society. Twelve sorts of Apples, two sorts of Pears. Flowers of *Chimonanthus fragrans*, and the *C. fragrans* var. *grandiflorus*, *Rhèum undulatum*.

Feb. 7.—Read. On the sowing of the Shirag tobacco; by Dr. Riach, medical officer in the service of the Hon. East India Company: communicated by Sir Henry Willock.

Distributed. Cuttings of the Elton and Choisey cherries.

Exhibited. Six sorts of Camellia, and *Cypripedium venustum*, from Messrs. Chandler of Vauxhall. *Enkiánthus quinquefórus* and *reticulatus*, from Wm. Wells, Esq. F.H.S. Pears, unnamed, from Sir W. W. Wynn, Bart., M. P. These proved to be a sort called the Russeting in the London market. Seedling Camellia, raised between Middlenist's and the double-striped; and an Enville and a green pine-apple, grown without fire heat; from Mr. Fielder, gardener to Wm. Linwood, Esq. These two pines were excellent specimens of winter-grown fruit; the Enville weighed 2½ lbs., and was well-flavoured; the Queen weighed something less than 2 lbs., but was rather acid. Two sorts of Apple, unnamed, and seedling Apples from the Knobby russet, from Wm. Nicol, Esq. Lemon pippins, from Mr. Hooker, F.H.S. Flowers of *Astrapæa Wallfichü*, from Mrs. Marryatt. Camellias from John Allnutt, Esq.

Also, from the Garden of the Society. Flowers. *Chimonanthus fragrans*, Gray's Invincible Camellia (or *punctata* of *Bot. Reg.*), *Rhèum undulatum*. — Fruit. Pears: Easter Beurré, Bon Chrétien Turc, Epine d'Hiver.

Feb. 21.—Read. A description of various modes of heating by steam for horticultural purposes; by Mr. Henry Stothert of Bath.

Distributed. Cuttings of the Washington, and Reine Claude violette plums, and of Knight's early black cherry: these three articles were from the Society's Garden.

Exhibited. A tree-pruner, from Robert Francis, Esq., Ivy House, Canterbury. Redding's camellia (a new seedling), Newtown pippins, *Strelitzia reginæ* and *ovata*, *Bryophyllum calycinum*, *Saxifraga lignàris*, *Dâphne hybrida*, from Mrs. Marryatt of Wimbledon. *Camellia japonica Vandèsii*, and *Vandèsii supérba*, from the Comte de Vandes. Camellias, from Messrs. Chandler and Sons. Gray's Invincible camellia, and Allnutt's seedling camellia, from John Allnutt, Esq. Specimens of netting, glasses for preserving fruit while growing, &c., from Mr. Griffinhoofe.

Also, from the Garden of the Society. Flowers. Gray's Invincible camellia (*C. punctata*, *Bot. Reg.*), Red, Blush, and White pæony-flowered camellias, *Rhèum undulatum*. — Fruit. Easter Beurré and Ne plus Meuris pears. Golden Harvey, Hunt's William Shakespeare, and Hunt's Duke of Gloucester apples, from T. Hunt, Esq. Poire d'une livre (the Catillac), Poire Léon Leclerc, Pomme de fouillet, Pomme de Rangé, from M. Léon Leclerc.

March 6.—Read. A paper on the cultivation of tobacco for garden purposes; by Mr. John Wilson, one of the under gardeners in the Society's Garden.

Distributed. Grafts of the following pears, from T. A Knight, Esq.: Monarch, Belmont, Downton, Rouse Leuch, Wormsley Grange, Moceas; also cuttings of his sweet red currant.

Exhibited. Josephine pears, from John George Fuller, Esq. F.H.S. A sprig of coffee with fruit, ground coffee, roasted coffee, raw coffee, and fruit of allspice, from Mr. J. Oliver, gardener at Coombe Abbey, near Coventry. 14 sorts of Apples from Mr. Stephen Hooker, F.H.S. Flowers of Glox-

Inia cándida, from Mr. J. Young, F.H.S. Newtown Pippins, from James Webster, Esq. F.H.S.

Also, from the Garden of the Society. Flowers, *Echevèria gibbiflora*. — Fruit. Winter Bon Chrétien pear, Easter Bergamot pear. Newtown Pippin apple, from Mrs. Marryat. — Tobacco, a large-leaved var. of Virginian.

ART. VIII. Covent Garden Market.

<i>The Cabbage Tribe.</i>		From	To			From	To
		£ s. d.	£ s. d.			£ s. d.	£ s. d.
Cabbages, per dozen :				Small Salads, per punnet		0 0 2	0 0 3
White	-	0 1 0	0 1 3	Watercress, per dozen small bunches	-	0 0 6	0 0 0
Red	-	0 8 0	0 10 0	<i>Pot and Sweet Herbs.</i>			
Plants, or Coleworts	-	0 2 6	0 3 6	Parsley, per half sieve	-	0 1 6	0 2 6
Savoy	-	0 0 9	0 1 6	Tarragon, per dozen bunches	-		
Brussels Sprouts, per $\frac{1}{2}$ sieve	-	0 1 6	0 2 0	Dried	-	0 0 0	0 3 0
German Greens, or Kale, per dozen	-	0 0 6	0 0 9	Forced	-	0 0 0	0 8 0
Broccoli, per bunch :				Chervil, per punnet	-	0 0 0	0 6 0
White	-	0 2 0	0 3 6	Fennel, per dozen bunches	-	0 3 0	0 4 0
Green	-	0 1 0	0 1 6	Thyme, per dozen bunches	-	0 2 0	0 0 0
Purple	-	0 1 6	0 2 0	Sage, per dozen bunches	-	0 0 0	0 3 0
<i>Legumes.</i>				Mint, per dozen bunches :			
Peas, forced, per pottle	-	0 5 0	0 7 0	Dried	-	0 0 0	0 1 6
Kidneybeans, forced, per hundred	-	0 3 0	0 4 0	Forced	-	0 0 0	0 8 0
<i>Tubers and Roots.</i>				Marjoram, dried, per dozen bunches	-	0 0 0	0 1 0
Potatoes	per ton	2 5 0	2 10 0	Savory, per doz. bunches	-	0 0 0	0 1 0
	per cwt.	0 2 3	0 2 6	Basil, dried, per doz. bun.	-	0 0 0	0 1 6
	per bush.	0 1 3	0 1 6	Rosemary, per doz. bunches	-	0 6 0	0 0 0
Kidney, per bushel	-	0 1 9	0 2 0	Lavender, dried, per dozen bunches	-	0 0 0	0 2 6
Scotch, per bushel	-	0 1 6	0 1 9	Tansy, dried, per dozen bunches	-	0 0 0	0 1 0
Jerusalem Artichokes, per half sieve	-	0 1 0	0 1 3	<i>Stalks and Fruits for Tarts, Pickling, &c.</i>			
Turnips, White, per bunch	-	0 0 2	0 0 3	Rhubarb Stalks, forced, per bundle	-	0 1 3	0 1 9
Carrots, per bunch :				<i>Edible Fungi and Fuci.</i>			
Old	-	0 0 4	0 0 6	Mushrooms, per pottle	-	0 1 6	0 0 0
Horn	-	0 0 6	0 0 8	Morels, dried, per pound	-	0 0 0	0 12 0
Parsneps, per dozen	-	0 0 9	0 1 6	Truffles, per pound :			
Red Beet, per dozen	-	0 1 0	0 1 6	English	-	0 0 0	0 12 0
Skirret, per bunch	-	0 0 0	0 1 6	Foreign	-	0 0 0	0 12 0
Scorzenera, per bundle	-	0 0 0	0 1 6	<i>Fruits.</i>			
Salsify, per bunch	-	0 0 0	0 1 6	Apples, Dessert, per bushel :			
Horseradish, per bundle	-	0 2 6	0 3 0	Nonpareils	-	2 10 0	3 0 0
Radishes :				Reinette grise	-	1 0 0	0 4 0
Red	per dozen hands (24 to 30 each)	0 1 6	0 2 6	Apples, Baking, per bushel	-	0 15 0	1 0 0
	per punnet	0 0 10	0 1 3	French	-	0 6 0	0 8 0
<i>The Spinach Tribe.</i>				Court-pendu	-	0 12 0	0 14 0
Spinach	per sieve	0 2 0	0 3 6	Pears, Dessert, per dozen :			
	per half sieve	0 1 3	0 2 0	Beurré rancee	-	0 0 0	0 18 0
Sorrel, per half sieve	-	0 1 6	0 2 0	Nouveau lise d'Hiver	-	0 0 0	0 12 0
<i>The Onion Tribe.</i>				Bon Chrétien	-	0 0 0	0 6 0
Onions, Old, per bushel	-	0 4 6	0 5 0	Almonds, per peck	-	0 4 0	0 6 0
For pickling, per $\frac{1}{2}$ sieve	-	0 3 0	0 5 0	Cranberries, per gallon	-	0 3 0	0 4 0
Green (Ciboules), p. bunch.	-	0 0 3	0 0 4	Strawberries (forced), per oz.	-	0 3 0	0 4 0
Leeks, per dozen bunches	-	0 1 0	0 1 6	Walnuts, per bushel	-	0 16 0	0 0 0
Garlic, per pound	-	0 0 0	0 0 8	Chestnuts, French, per peck	-	0 6 0	0 12 0
Shallots, per pound	-	0 0 8	0 1 0	Grapes, per pound :			
<i>Asparaginous Plants, Salads, &c.</i>				Hot-house	-	1 15 0	2 0 0
Asparagus, per hundred :				Spanish	-	0 1 0	0 0 0
Large	-	0 10 0	0 12 0	Black Portugal	-	0 2 0	0 0 0
Middling	-	0 4 0	0 6 0	Cucumbers, frame, p. brace	-	0 8 0	0 16 0
Small	-	0 2 6	0 3 0	Oranges	per dozen	0 0 9	0 3 0
Seakale, per punnet	-	0 1 6	0 3 0	per hundred	-	0 3 6	0 18 0
Cardoons, per bunch (3)	-	0 4 6	0 6 0	Lemons	per dozen	0 0 9	0 2 0
Lettuce, per score :				per hundred	-	0 6 0	0 14 0
Cos	-	0 1 3	0 2 0	Sweet Almonds	-	0 3 0	0 0 0
Cabbage	-	0 0 6	0 0 9	Nuts, per peck :			
Endive, per score	-	0 4 0	0 4 6	Spanish	-	0 6 0	0 0 0
Celery, per bundle (12 to 15)	-	0 0 6	0 1 6	Barcelona	-	0 6 0	0 0 0
				Messina	-	0 2 6	0 3 0
				Brazil, per bushel	-	0 14 0	0 16 0

Observations. — Having been favoured by open moderate weather throughout the winter months, our supplies at market have been very regular, and the prices consequently moderate. From the present state of the soil, which has been kept cold by the general absence of solar heat, the spring may be expected to be late; and as the winter supplies of vegetables have been regularly consumed, it is highly probable that the prices for the ensuing month will be higher; and that the forced vegetables will be more in demand, such as asparagus, sea-kale, radishes, rhubarb, &c. &c. Cabbages of excellent quality have been already furnished in good supply, and at a moderate price; broccoli of the fine early white variety has been abundant, and as the whole crop remains uninjured by frost, it may be expected in still further quantity, which, with the purple and brimstone varieties, so extensively cultivated, will make up for the late coming in of the general crop of spring vegetables. Onions still support a uniform price, contrary to a general impression that they are dearer in frosty weather. Turnips still continue to be excellent in quality, owing to their not having run off so readily to tops, which have not been so abundant as usual, and have been disposed of freely, and to advantage. Our supply of foreign fruit has been very limited, and at rather high prices, as may be observed on referring to the list. Apples, the produce of our own soil, are extremely scarce, a few bushels only from time to time coming to hand; as the growers can realise more for them in the country, the prices here being much reduced by the importation of foreign fruit.

Our stock of winter pears is very small; indeed, we are, in the market, altogether wanting a supply of the better varieties. As yet the culture of the new French sorts has not become general, nor do the growers feel justified in holding them over, in the fear of a supply from abroad. Potatoes are extremely abundant and cheap; a supply could be obtained equal to any demand, did the prices afford remuneration to the growers and shippers; but the expenses of freight, &c., from the distant counties, and from Scotland, from which we now obtain the most extensive supplies, is so high as almost to insure a total loss of price to the cultivator. — *G. C. March 20. 1831.*

ART. IX. *Obituary.*

DIED, on the 16th of July, 1831, *Johann Martin Fleischmann*, chief superintendent of vineyards, and the Nestor of the writers of Saxony. He was in the eighty-fourth year of his age, fifty-seven of which he had passed in official service. He was born in 1747, at Schwarza in the Grafschaft of Stollberg-Werningerode, where his father was a merchant. He devoted himself to gardening, and received instructions in that art from Putmann, court-gardener at Meiningen. He afterwards travelled over a great part of Germany, and in 1775 was appointed court-gardener of what is called the Japanese garden at Dresden. The extensive information respecting the cultivation of the vine which he had acquired in his travels, especially in the districts of the Rhine, induced the Electoral Prince, in 1793, to appoint him superintendent of vineyards. In 1799 he founded the Meissen Society for the Cultivation of the Vine. His writings are chiefly on botany, the cultivation of the vine, the growing of wood, and the rearing of the silkworm. That insect, he conceived, might be naturalised in Saxony. He also published several treatises on the mulberry tree; and, conjointly with Nicolai and Riem, translated the celebrated work of Count Landriani on the rearing of the silkworm, accompanied by notes. (*From a German Paper.*)

Died, at Mile End Nursery, on the 5th of January last, *Mr. Archibald Thomson*, aged 79 years.

This eminent nurseryman, who was related to the celebrated poet of the same surname, received the rudiments of his horticultural education under his father, in the vicinity of Edinburgh; and afterwards, in England, improved himself so much, that he was appointed botanic gardener to the Earl of Bute, at Luton Hoo, in Bedfordshire. In this, at that time, first-rate situation, his abilities as a practical botanist, and his conduct as a man, not only gained for him the approbation and patronage of his noble master, who was a distinguished lover of plants, but also the friendship of Messrs. Gordon and Denner, seedsmen in Fenchurch Street, and nurserymen at Mile End, near London, by whom he was invited to superintend the latter department of their business; and was admitted a partner in that respectable firm upwards of 50 years ago.

The Mile End Nursery was at that time one of the first about London; and it was much extended and improved by Mr. Thomson. The collection of hardy trees and shrubs was unrivalled; and very many of our finest American and other exotics were introduced through, and their cultivation determined in, that nursery. Mr. Thomson was excessively fond of fine specimens of his various stock; and, no doubt, had much personal gratification in their preservation: but he lived to see that, though this was a road to fame, it led not to the reward it merited. Many of these specimens are now on sale, in the possession of his son and successor, and are well worth the attention of collectors who are forming arboretums or public gardens. *Magnolia Thomsoniana*, amongst other estimable plants, is commemorative of Mr. Thomson's skill and assiduity; and his modes of practice in the propagation and nursery culture of plants will ever remain, as they have long been, the guide of his numerous pupils and brethren in the profession, by whom he was always highly respected. — *J. M.*

Died, at Woodhall in Lanarkshire, the seat of W. F. Campbell of Shawfield, on Monday the 16th of January, *Mr. Walter Henderson*, aged 73. He had filled the situation of gardener at Woodhall for 47 years, justly esteemed as a first-rate practical and scientific horticulturist, and combining with strict integrity of character an amiability of manners which endeared him to all who had the pleasure of his acquaintance; while his unostentatious kindness, and facility in communicating professional information, will be long remembered with gratitude, not only by a numerous list of gardeners educated under him, but by many in the profession who were within reach of benefiting by his friendly instructions and advice. — *S. M. G.*

Died, January 25., deeply lamented by his family and a numerous circle of friends, *Mr. James Colvill*, nurseryman of the King's Road, Chelsea, in his 55th year.

Died, in London, February 4., the *Comtesse des Vaudes*, who, for many years, was a patroness of practical botany, as may be seen by the numerous plants which have been figured, in the botanical periodicals, from her well-known botanic garden at Bayswater. We regret to learn that the collection is to be sold; as we were in hopes that the count would have retained it, or that some arrangement might be made to keep it up as a subscription botanic garden.

THE
GARDENER'S MAGAZINE,
JUNE, 1832.

ORIGINAL COMMUNICATIONS.

ART. I. *General Results of a Gardening Tour, during July, August, and part of September, in the Year 1831, from Dumfries, by Kirkcudbright, Ayr, and Greenock, to Paisley.* By the CONDUCTOR.

(Continued from p. 134.)

IN our last fragment, we offered a few remarks on fences in parks and pleasure-grounds, and our present article was intended to be devoted to plantations; but, as there is now, happily, a great spirit in the country for the improvement of cottages, we shall give that subject the preference. The depressed state of the agricultural population in England, the consequent pressure of the poor-rates in some places, and the outrages of incendiaries in others, have forced the attention of the landed proprietors to the means of ameliorating, or at least quieting for a time, their territorial population; and, in consequence, we have heard, for upwards of a year, of cottages being repaired, and land allotted to cottagers at moderate rents, throughout most of the English counties. Within the last six months the alarm occasioned by the cholera has caused increased attention to be given to the subject of comfortable cottages for agricultural labourers, and to that of the condition of the poor generally; cleanliness, warmth, proper ventilation, and wholesome food being found the best preventives of that disease.

The dwellings of the working classes, and especially those on the country residences of landed proprietors, and in the

manufacturing villages in the west of Scotland, have been certainly somewhat improved since the last time we passed leisurely through that country, in 1805 ; but they are still lamentably deficient in several important particulars. The causes of these deficiencies may be partly traced to the landlords, who generally build the cottages ; but principally to the habits of the occupiers. For, on taking an enlarged view of the subject of social improvement, it will be found that the state and condition of every class of men depend chiefly upon themselves. If the working classes, as a body, determined on bettering their condition, maturely considered the means of doing so, and united in setting about carrying these means into effect, most assuredly they would attain their end. At the same time, something is to be expected from the benevolence of the wealthy ; more especially from the employers of gardeners, bailiffs, and other resident servants in country seats ; and it is chiefly to these enlightened and liberal proprietors, and their agents, that we now address ourselves.

The cottages in the west of Scotland may be divided into three classes : —

1. Those built by small tradesmen, mechanics, or other workmen, for their own occupation, on feued land ; that is, land held on very long or perpetual leases, at a rent of, generally, from 10*l.* to 15*l.* an acre.

2. Cottages built by proprietors, for their servants, as gardeners, bailiffs, gamekeepers, &c. ; for their mechanics, as carpenters, smiths, &c. ; and for their field labourers, &c.

3. Cottages built by farmers for their yearly servants.

We shall notice what we consider to be the faults and deficiencies of each of these classes in succession ; and conclude by hinting at an unpardonable defect in the whole of them.

1. *Peuars' Cottages.* — The chief objections which we have to these are the two following : — first, the forming of sleeping-rooms in the roof, and making them so small, and with such diminutive windows, that they never can be well ventilated ; and, secondly, the not raising of the ground floors 1 ft. or 2 ft. above the level of the surrounding surface. The importance of a continual supply of fresh air to health, and of dryness to warmth, is not at all understood by the dwellers in cottages generally ; otherwise we should not have so many of these buildings with small window-frames fixed in the wall, so as not to admit of opening them for ventilation. A low damp floor is doubly injurious, by the evaporation of its moisture carrying off heat, and by the vapour in the atmosphere of the room diminishing the proportion of oxygen in every mouthful of air inhaled by the lungs. The windows should always be

made large, and their sash-frames contrived to open, either by having hinges, or by being suspended and balanced by weights. The floors should not only be raised, but on all moist soils the material used in raising them should be loose stones, rendered level at top by smaller stones and gravel, and finished either by pavement, or a composition of lime, smithy ashes, and clean sharp sand. Where fuel is very scarce and dear, flues might be formed in these floors, and these might be heated occasionally in winter by fires of brush-wood. The feued cottages in the village of Catrine, in Ayrshire, are exceptions to most others which we have seen in the west of Scotland, in dryness, light, ventilation, and, in short, in all other respects.

The radical cure for these evils is to be found in the scientific education of the rising generation at the parochial schools. Once render men fully aware how essential pure air is to the human frame, and how much dryness contributes to warmth, and they will take care not voluntarily to live in dwellings deficient in these important particulars. In the mean time, something may be done towards opening the eyes of the reading part of the adults, by cheap tracts, and by essays on the subject in the newspapers and magazines.

2. *Cottages built by Landed Proprietors for their Servants.*—The principal fault which we have to find with this class of dwellings is, that the taste which they affect to display is too often at variance with the principles of utility and convenience; and yet nothing can be more certain than that utility is the fundamental principle of all permanent beauty.

The beauty of which cottages are susceptible is of three kinds; and must result either from their actual fitness for being human dwellings, from their being outwardly expressive of that fitness, or from their style of architecture. The first of these beauties is technically called the expression of design, or fitness; the second, the expression of purpose; and the last, the expression of style. Every cottage whatever ought to display the two former qualities; and what are called ornamental cottages, or such as gentlemen who possess parks or pleasure-grounds generally erect in them as entrance lodges, or as dwellings for their servants, ought to display the latter. Gothic cottages belong to the ornamental class; but if they are examined with reference to the principles of fitness, or of expression of purpose, they will commonly be found wanting. For example, their windows are low, and do not reach to the ceilings of the rooms, which must always render the ventilation of the apartments imperfect. Their window frames are filled in with lattice-work; and these frames shutting against

mullions, or broad upright and cross divisions of the window, must impede the entrance of light. Gothic windows are also, as they are generally constructed in cottages, less air-tight, and the mode of giving air by them is much less convenient, than that by the common suspended and balanced sash windows. The reason of these sins against fitness, in cottages pretending to the beauty of architectural style, may be thus given :— The general character of a cottage, as distinguished from that of dwellings of a higher class, is considered by architects to consist in low walls, and, of course, low ceilings ; small windows, broad rather than high ; and conspicuous roofs, generally with windows in their sides. We admit, that, taking cottages as they are usually constructed, these features may be said to constitute their character ; and hence they would be employed by a painter, or poet, or a descriptive writer, who wished to portray a cottage of the present day.

Thus, a certain degree of coarseness and homeliness of dress and manner may be said to have hitherto characterised the British labourer, as contradistinguished from the British gentleman. A romantic writer would, therefore, make use of these characteristics ; and a poet or a sentimentalist would probably regret their disappearance, and the gradual assimilation of dress and manners between the labourer and the gentleman. The fault of the architect is, that he has too closely followed the painter and the man of literature ; forgetting that his art, being founded upon and guided by utility, ought to embrace all improvements, not only in architecture, but in the uses of buildings, as they are brought into notice. The fault of the landlord is, that he has thought of little except the outside show of his cottages ; but it is surely as much his interest to encourage whatever will raise and elevate the character of the people who live on his land, as it is the duty of the architect to consider, not what a cottage has hitherto been, but what it is capable of being made. Putting a servant into a handsome Gothic cottage is like putting him into a handsome suit of livery : but there is, unfortunately for the servant, this difference, that the faults of the dwelling, if it does not fit, cannot be so readily perceived as those of the coat ; and nobody may know, but the occupant and his family, how little comfort sometimes exists under a gay exterior. For our own part, we have seen so many ornamental cottages and lodges on gentlemen's estates, both in England and in Scotland, small, damp, and badly contrived within, that we are compelled to consider them as much badges of slavery as a suit of livery. Let us hope that another generation will

effectually simplify and improve the former, and entirely abolish the latter.

We are aware that there is a great prejudice in favour of Gothic buildings of every description, from the cottage to the palace; arising from the associations of reverence, antiquity, and chivalry, which are connected with them. Maturely considered, however, we cannot help sometimes doubting whether the existing prejudice in favour of Gothic architecture does not reflect more discredit than honour on human nature; at all events, it is a prejudice unworthy of an age of rapid improvement like the present. We freely acknowledge that we do not expect many converts to our views in this respect; because simplicity is one of the last refinements, not only in the progress of the arts, but in the progress of opinion. Believing, as we do, that this principle is undeniable, we have little doubt but that much of what is now considered beauty, both in art and in literature, will by the next generation be neglected, and, as the French characteristically express it, "réduit au mérite historique."

However, as a superabundance of wealth must find means of displaying itself, let there be Gothic or other fanciful cottages and lodges; but let not fancy be exercised on them at the expense of the health and comfort of the inhabitants. Let architects and their employers begin by such dimensions and arrangements as will insure commodiousness, and every requisite convenience; let there be lofty ceilings for a large volume of air; large windows for abundance of light, and for ample ventilation; a raised floor, and thick walls, to insure dryness and warmth; and fireplaces, flues and chimneys always placed in the interior walls, and never in the outside ones.* Having fixed these points, superadding sound foundations, materials, and workmanship, there can be no objection to the exercise of such taste, or no taste, as the parties may possess. A little of the absurd, indeed, sometimes does more for general improvement than the good, because it calls forth criticism.

3. *Farm-Servants' Cottages.* — The cottages erected by farmers for their yearly servants cannot be expected to be either commodious or substantial; because in Scotland they are built with a view to the duration of a nineteen or twenty-one years' lease, by a party who never can have much capital to spare for such a purpose. It is true, the landlord generally makes a certain allowance for the erection of such cottages; but, not-

* Further remarks on this subject will be found in our *Encyclopædia of Cottage, Farm, and Villa Architecture*, Part I. p. 8.

withstanding this, we believe they will invariably be found the worst description of dwellings in Scotland. Perhaps it will hardly be credited in a future age, that while Scotch farmers, confessedly the most enlightened agriculturists in the world, are not intrusted with the erection of stables and buildings for lodging cattle, and for the other purposes of the farm-yard, they are yet permitted to erect dwellings for human beings. The farm-yard is usually built from the plan, and at the expense, of the landlord, under the superintendance of his architect and factor ; but a sum is generally allowed to the farmer, for the erection of such cottages as he may require for the lodging of his yearly servants ; and these cottages he plans and executes, uncontrolled by any other powers or principles than those suggested by his own feelings of propriety and justice. That these are often low in the moral scale, there are but too many examples to prove. It is a well known fact, that no Scotch manufacturer ever ventures to erect such cottages for his workmen as a farmer does for his labourers. If he did, he would only have the very lowest description of Irish to live in them, as is the case with certain cottages along the west coast ; for example, at Stanraer and Girvan. With the progress of things, we have no doubt that this practice will be done away with ; and that the farmer's yearly servants will, at least, be placed on the same footing as his horses and cattle. It is now the interest of the farmer to lodge his servants as cheaply as possible ; and the interest of the landlord to get as high a rent for his land as he can, with the least outlay of capital for repairs and new erections : but men's views of interest change ; and, with a superior degree of human cultivation among all classes, a more refined description of self-interest will require to be gratified. To some landlords, to see and to know that all who live on their estates, and especially the poorest class, who, isolated and ignorant as they now are, cannot help themselves, are comfortable, and possessed of the means of happiness, is a necessary of life. As society advances, this class of landlords will become more numerous, and this is one source from which we look for the amelioration of the lowest description of human habitations in Scotland.

Another source, however, and the one on which we chiefly depend, is the growing intelligence and taste of the cottagers themselves. The agricultural population of no part of Britain is yet sufficiently enlightened to act by cooperation ; but, with a proper system of national education, and the free circulation of political and moral knowledge, both of which we hope soon to see established, the operative agriculturists,

like the operative manufacturers, will be enabled to command such dwellings, and other means of subsistence, as their superior condition will require. At present, what are called the lowest class in Scotland, and especially the agricultural labourers, consider themselves as living by the sufferance of those who are above them; and nothing but knowledge can eradicate this degrading idea, and relieve them from the numerous privations which they undergo in consequence.

We are persuaded that many absentee landlords are ignorant of the sort of cottages which already exist, and still continue to be erected, on their estates. It is difficult for us to persuade ourselves that the wives, who are perhaps mothers, of these men of wealth, are aware of the large families that are born and live together in one square room, open to the roof, with no division but that formed by wooden bedsteads, and with no floor but the earth. We cannot believe, for example, that the Duchess of Buccleugh, whom we know to be highly cultivated, and who has the reputation of being kind-hearted and charitable, ever entered any one of the fourteen cottages lately erected on one of her husband's estates, not far from his magnificent palace of Drumlanrig, in Dumfriesshire. On crossing the country from Jardine Hall to Closeburn, Aug. 9. 1831, we passed the farm of Cumroo. The farm-house and farmery are ample and most substantial-looking buildings. The dwelling-house is more than usually large, with two rooms in its width; a part of its exterior wall is covered with large well-trained fruit trees; and there is an excellent kitchen-garden, well stocked, and apparently in good order, in which a professed gardener (judging from his blue apron) was at work; so that the whole, had it not been for the farm-yard behind, might very easily have been taken for a mansion residence. Passing this house, and advancing about a furlong, we came to a row of fourteen cottages occupied by yearly servants of the farmer and occupant of the large house, who, we were told, came from the best cultivated district in Scotland, East Lothian. Observing that to every door in the row of cottages there was but one window, we entered one of them, and found a woman sitting at a table, writing a letter (which seemed in a very good hand for a person in her rank of life), while she rocked the cradle with her foot. The room, which comprised the whole cottage, was about 14 ft. square, without a ceiling, and open to the roof; the floor was of earth, and the walls were left rough, just as the stones were put together in building, but whitewashed: there was a fireplace, but only one fixed window of four small panes. In this room there were two box beds, placed end to

end, and behind them a space of about 2 ft. in width for fuel and lumber. The furniture and utensils, though scanty, were clean and neat; more especially when contrasted with the floor, which, underneath the beds, was of earth, quite loose; though, near the fire, were laid some flat stones, which the woman said her husband had picked up and put down himself. The cottage window, as already observed, was fixed, and incapable of opening to give air. There was no back door, and no opening either in the roof or walls for ventilation, except the entrance door and the chimney. There was no appendage, or garden ground of any sort, behind these cottages; but, across the road, in front of them was a narrow strip of ground, divided so as to allow one fall (36 yds. square) to each cottage. In these gardens there was no structure of any kind.

We repeat, that we cannot believe that the Duchess of Buccleugh is aware that there are such cottages on her husband's Scotch estates: probably even the duke may be equally ignorant; and, in that case, the blame must be considered as attaching to his managers; and these, again, may very probably excuse themselves (for there are always plenty of excuses for every thing), on the ground of not feeling justified in departing from what is deemed customary in like cases. This confirms what we have always stated; viz., that the reform and amelioration of any class of society, to be effectual and permanent, must proceed from that class itself. When the labouring classes have a decided taste for an improved description of cottages, and for larger gardens, they will, as we have said before, never rest satisfied till they have procured them.

But, though we maintain this doctrine, we hold also that something is to be expected, in favour of the poor and ignorant, from the generous feelings of the enlightened and wealthy; and therefore we consider it to be the duty, as we are certain it would contribute to the happiness, of all proprietors who can afford it, to endeavour to raise the character of the human beings on their estates, by improving their dwellings. No man can compel the Duke of Buccleugh to issue an order that no cottages shall be built on his estates with less than three rooms, and other conveniences, and a garden of at least the fourth part of an acre unalienably attached; but all who are aware of the immense extent of the duke's possessions expect more from him than they do from less wealthy proprietors.

Having described the sort of cottages erected for farm-labourers in Dumfriesshire, we shall now notice those erected

for the same class in the Rhinns of Galloway, on the estate of Mr. Macdouall of Logan. These erections, for which the name of hut or hovel would be more appropriate than that of cottage, are built of turf, or mud, or stones, or of a mixture of all these. They are commonly covered with straw, though sometimes with slates. The interior of each contains but one apartment, open to the rafters (which, as may be expected, are blackened by smoke), and having no floor but the earth. The fire is made on the ground, at one end of the room; and, by way of chimney, a quadrilateral structure of straw rope, warped around a frame of wood, is projected from the wall over the fire, and continued upwards through the roof, terminating about 1 ft. above it. The windows are very small, and fixed. Mr. Macdouall receives sixpence a week for cottages of this kind, from labourers to whom he pays tenpence a day, the common wages of the district. A gentleman resident in that part of the country told us that he knew one of Mr. Macdouall's labourers, who, in one of these cottages, and on the above wages, from which all broken time is deducted, has to support a wife and six children. Rags, filth, cutaneous eruptions, and sometimes atrophy, in the children; emaciation, debility, and premature old age, in the adults, are the inevitable effects of this state of existence. It is but just, however, to add that Mr. Macdouall grants, by way of indulgence to his labourers, land on which they may grow their potatoes, provided they manure and clean it.

Having pointed out the separate faults of these three classes of cottages, we shall now state what appears to be their greatest defect, and which is common to them all.

Every one who has lived any time in England is aware that the humblest cottage in that country has an appendage to it, essential not only to cleanliness, but even to decency. It is hardly credible, but it is nevertheless a fact, that these appendages are scarcely ever to be met with throughout the west of Scotland. There are even new and substantial farm-houses, and first-rate gardeners' and bailiffs' houses, without them. Some gentlemen who have built themselves handsome mansions, and erected elegant lodges at their entrance gates, have altogether neglected to add this necessary convenience to those lodges. Not far from Ayr, we found a new village, consisting of about a hundred houses, all feued; and we ascertained from one of the inhabitants, that there were only three of the houses to which this appendage was attached. It is not to be wondered at, therefore, that the outskirts of all the villages and of all the towns, and the immediate neighbourhoods of all the cottages, in the west of Scotland are most offensively

disfigured. That the general absence of the conveniences alluded to, in this district, is clearly owing to the general want of a taste for cleanliness and decency (in the particular alluded to) among the inhabitants, and not from want of means to procure them, is evident from the circumstance, that every house in the above village is the property of its occupant, who might have built upon his ground whatever he chose. It appears, also, that this want of cleanliness and decency is not inconsistent with a high degree of cultivation in other particulars; for, the same village being at a distance from the parish school, the inhabitants have joined together, built a school-house, and hired a teacher, to procure for their children the benefits of education. This neglect of minor comforts, and attention to important advantages, is characteristic of our countrymen; and is, no doubt, in some points of view, highly honourable to them; but, to place them on a par with their southern neighbours, in point of domestic comfort and refinement, the improvement which we hinted at is essentially necessary. Proprietors who have lived in England ought to set the example in all the cottages and farm-houses which they build on their estates; and, when they arrange with their farmers to build dwellings for their yearly servants, it ought to be a condition that this appendage should not be wanting.

Though we were aware of the state the country was in, in this respect, twenty-six years ago, we did expect to find it somewhat improved at the present day. We hardly think, however, that any improvement has taken place, and would most earnestly recommend the subject to the attention of proprietors, and to their factors, architects, gardeners and bailiffs.

(To be continued.)

ART. II. *Horticultural Notes on a Journey from Rome to Naples, March 1—6. 1832.* By WILLIAM SPENCE, Esq. F.L.S.

Sir,

HAVING employed a rainy morning or two in writing out, and occasionally expanding, a few pencil notes relating to horticulture, made during our late journey from Rome to this place, I send them for your Magazine; in the hope that, though necessarily slight and superficial, they may interest some of your readers who have not had themselves an opportunity of passing by the same road; and who will, perhaps, excuse their assuming here and there an agricultural complexion.

I am, Sir, yours, &c.

Naples, March 10. 1832.

W. SPENCE.

Market-Gardens. — These are not numerous without the gate of Rome leading to Naples; indeed, by far the larger portion of the market gardens of Rome are within the walls, which are twelve or fourteen miles in circuit, without having more than one third of the enclosed space covered with houses. On the Naples road, as within the gates, they present the same general features: industrious though not very neat cultivation, and the soil kept constantly cropped under great breadths of lettuces, endive, leeks, broccoli, superb cauliflowers; and especially two articles which occupy more space than all the rest, viz., *gobbo* and fennel. *Gobbo* (hunchback) is the appellation which the Italians, in their well-known love of nicknames, have given to the gibbous footstalks of the first set of leaves, just as they branch from the ground, of a variety of artichoke; which are blanched by hoeing up the earth against them, and of which a far larger quantity is consumed than of the heads of the plants. Fennel is cultivated to a great extent for precisely the same part of the plant, namely, the blanched footstalks (and roots) of the first set of leaves; and both it and *gobbo*, when stewed in the Italian method, form excellent dishes. These fennel roots and footstalks are eaten also raw, as a salad, with oil and vinegar. What most distinguish Roman (and, indeed, Italian) gardens from those of Northern Europe are the shed, and wheel which it covers, for drawing up water, by means of an ass or ox, from the adjoining well, for the purpose of irrigation; and the clump of fine reeds (*Arundo Donax*), each 15 ft. or 20 ft. high, and 1 in. in diameter, and as strong as a bamboo of similar thickness (which they resemble), which are employed as props and trellises for vines, and for fences, garden-sticks, and various other uses.

Albano. — Viewed the lake here, and that of Nemi near Gensano, which occupy the craters of two extinct volcanoes: pretty, but too exactly circular to be very picturesque; and the want of bays and indentations of margin not compensated (at least, as far as could be judged at this season) by any striking masses of large trees; the wood which clothes the surrounding hills seeming chiefly coppice. Indeed, the absence of fine full-grown trees is the great defect of landscape scenes in Italy, where you sometimes travel a hundred miles (as in Lombardy) without setting eyes on a tree that has not been pollarded or lopped; and though, on the hills, the chestnut is allowed to expand at will, it seldom attains there that luxuriance of growth which adorns the natives of the moister mountains of Switzerland. Great part of the apples

and other fruit consumed at Rome are brought from Albano, Velletri, &c.

Pontine Marshes. — The desolate aspect attributed to these twenty-four miles of the road to Naples is one of the many exaggerations which prevail with regard to Italy. The view is bounded to the left, at a short distance, by the Apennines; and to the right, at the distance of some miles, by a line of extensive woods; the intermediate space being partly under cultivation (but chiefly in grass), with vast herds of horses and buffaloes feeding: and though the dead-flat surface, and the occasional (but not very frequent) occurrence of portions covered with reeds, or overflowed with water, give the whole a fenny character, yet, as, happily, there are no pollard willows, and the road (a great rarity in Italy) runs the whole way between two rows of tall elm trees (now in flower, and thus taking at a distance a tinge of green, as if breaking into leaf), the general effect to the eye is not at all offensive, and far less repulsive than some parts of Holland or Lincolnshire.

Terracina. — The change, on arriving here, is like enchantment. The whole way from Rome, for upwards of forty miles, presents few Italian features, and, least of all, the Pontine Marshes; immediately on leaving which, you burst at once on lofty rocks, close to the Mediterranean, clothed with vines and fig trees, and orange and lemon trees, superb cactuses (*Opuntia vulgaris*), *Euphorbia dendroïdes* in full flower, and palm trees (*Phœnix dactylifera*) 20 ft. to 30 ft. high; all giving quite a new and southern aspect to the scene. Struck with this sudden change, some travellers have said that here is strictly the gate of Italy, properly so called; and that what is usually understood by an Italian climate and productions must be confined to the region south of Terracina. This, however, is an error, originating in the want of more comprehensive observation; for every one of the productions found at Terracina, with the addition of aloes (*Agave americana*), of which few or none happen to grow there, may be seen as far north as Geneva and Nice; where palm trees are cultivated, to sell their leaves to the Romish churches for Palm Sunday. The fact is, that the true Italian climate is confined to a very small portion of Italy, namely, to some favoured spots on the western coast; and that along its whole extent, whenever the approximation of the Apennines to the sea, at once keeping off the north and east winds, and reflecting the sun's rays, affords the temperature which the orange and lemon, &c., require. The moment you recede from the coast, especially if a very trifling elevation of ground takes place, farewell to oranges and lemons, at least in any

perfection. Even at Caserta, the King of Naples's country-seat, though but fifteen miles east of Naples, and not above from 150 ft. to 200 ft. higher, the oranges, we were told, are very indifferent, and that the great canal in the garden is frozen over every winter, and the cascades converted into masses of ice; and, wherever aloes are planted at Naples in open and unsheltered situations, they are constantly cut and stunted.

Mola de Gaeta. — Between Terracina and Mola, numerous carob or locust-bean trees (*Ceratonia Siliqua*) grow, intermingled with the olives; and being also evergreen, but with leaves of a lighter green somewhat resembling those of the common acacia; and the hedges being mostly composed of laurustinus, sweet bay, and myrtle; while the banks were covered with *Erica arborea*, *Asphodelus ramosus*, *Echium italicum*, *Lycópsis* [*Nònea*] *bullata*, &c. &c.; all, like the laurustinus and sweet bay, in full flower; it needed an effort of recollection to recall to mind that it was still the first week of March. The carob trees, however, though more abundant here than we had before observed them, are also cultivated as far north as Genoa; where, as here, their long, compressed, and very sweet pods are both eaten by the common people and given to horses. At Mola, our inn, which had formerly been the villa of an Italian nobleman, was delightfully situated in the middle of a garden, and commanded the finest views of the Bay of Gaeta (second in beauty only to that of Naples), and included in its bounds the supposed ruins of one of Cicero's villas (his Formianum), close to the water's edge. These ruins were shown to us by the gardener who rented the garden in which the inn stood; which seemed altogether about two acres in extent, and was chiefly occupied with orange and lemon trees, to the number of 700, now laden with fruit. For this garden, he told us (and the landlord confirmed his statement), he pays 600 scudi or crowns (about 120*l.*) a year rent; a sum which may give an idea of the high value of these favoured spots of land suitable to the orange and lemon. The price of the largest oranges, which are of excellent quality, on the spot, to be sent to Rome, &c., is 3 paoli (15*d.*) a hundred; and he pointed out one of the orange trees, of middle size, which had this year borne five hundred. He gave us some sweet lemons, not differing in appearance from common lemons, except that they were extremely more rugged, but with juice of an insipid sweet taste, and without the slightest acidity.*

* At Naples another curious variety of lemon is exposed in the streets for sale, having externally the exact colour and shape of an orange, except that at the stalk end is a depression, and on this a prominence, as in the lemon, but within having the pale pulp of the lemon, and sweet juice.

Capua. — Our rooms at the inn at Capua, where we slept, opened on a terraced garden, with orange trees, vines trained on arched trellises, marble fountains, &c., which, for ten shillings' expense, might have been made very gay and attractive; but all was forlornness and disorder, the beds untrimmed, and the walks littered with dirt. Two magnificent plants of *Opúntia vulgàris*, which flanked one of the windows, the waiter said, were planted there "*per pompa*" (for pomp's sake); a motive, unfortunately, so often the leading one in Italy, without any regard to the humbler ones of neatness and order. On the opposite side of the street, however, we espied, on the ramparts, what is a great rarity in the small towns of Italy, a public garden; which, though disfigured by a profusion of ugly temples, grottoes, &c., was of tolerable extent, with handsome parterres of flowers, and trees of sufficient growth to give shade; the whole kept very neatly, and forming a great ornament to the town.

Caserta. — The gardens of this vast and magnificent country palace of the King of Naples are not a very favourable specimen of the old style of gardening. There are no trees of the luxuriant growth of those which adorn the Boboli garden at Florence, or that of the Villa Borghese at Rome; and the row of evergreen oaks on each side of the great canal, being kept clipped to the height of only about 15 ft., have a very stunted and paltry look. On the whole, this is among the few old gardens which one would not regret to see converted into a *jardin Anglais* [English garden], as far as practicable; and, perhaps, all the old gardens would be much improved, without losing their distinctive character, by one simple alteration, the substitution of the pruning-knife for the shears; and, while the vistas and alleys were preserved, permitting at least their upper branches to assume a natural mode of growth. Turf, extremely rough, as it always is on the Continent, yet without bare patches; and so far proving, like the scores of plots of grass to be seen in Italy (as in front of the cathedral at Pisa, and the church of S. Giovanni in Laterano, at Rome, &c. &c.), with as short and fine a turf of white clover, &c., as most village greens in England, that the notion of the heat being an insuperable obstacle to having fine grass in the south of Europe is erroneous; and I am persuaded that, if due attention were given to having a proper soil, sufficiently retentive of moisture, it would be easy to have grass plots in Italy, if treated in the same way as to rolling and mowing, very little inferior to what are seen with us. Bundles of green lupine plants pulled up by the roots, and of the roots of couch grass which we burn but which the Italians

more wisely give as a saccharine and grateful food to horses, are exposed for sale in the square of the town of Caserta.

Campagna Felice is the title given to the extensive level tract of land which lies between the mountains to the north-east of Caserta and Naples, and the Mediterranean; perhaps to distinguish it from the Campagna of Rome, so much the reverse of "felice." But why should the Neapolitan plain, which is a dead level, be free from fever, and the Roman Campagna, which has a much more undulated surface, and is 130 miles farther north, be the prey of malaria? This is a mystery of which no satisfactory solution has been offered; for the supposed noxious influence of volcanic substrata exists here in as great a degree as around Rome. The whole of the Campagna Felice is cultivated like a garden, precisely on the same general plan as the plain of Lombardy, which it resembles alike in fertility and insipid sameness to the traveller. Rows of lopped elms or poplars intersect the fields, at the distance of 40 or 50 ft. between each row, to which vines are trained: and the intermediate space is occupied by luxuriant wheat, in some fields of which, parties of twenty or thirty men and women were weeding; lupines, pulled green for fodder; garden beans, now mostly in flower; or ground prepared for ploughing by two oxen, without a driver, for Indian corn, &c. This is one of the grand advantages of the climate of Italy, that, while in northern Europe vast tracts of land are devoted to the exclusive growth of barley for beer, the Italians obtain a far better beverage from the very same land that supplies their bread corn, and without materially interfering with its produce: for both the vines and the trees that support them are planted so deep as to consume only the manure, which, in any case, would be washed away; and their slight shade is rather beneficial than injurious to the crops below.

Naples. — Vegetables in the markets of the same kinds as at Rome, with an equal abundance of gobbo and fennel roots, and green peas in greater plenty. Grapes, of several varieties, kept through the winter, not much shrivelled, and quite free from mouldiness. Two or three sorts of apples, but only one of winter pears, as is the case also at Florence, Pisa, and Rome; and apparently the same variety, which is good, but hardly so superexcellent as to deserve to exclude all other kinds. Oranges, in glorious profusion (chiefly from Sorrento, fifteen miles distant), and so cheap as to allow the poorest of the poor to enjoy (what Dr. Johnson complained he had never had of peaches but once) their fill of them, and that daily. The middle-sized ones (which are the best) sell at four for a grano, which is at the rate of ten for a penny English;

and the poor get twice as many of those beginning to decay. A brilliant display of flowers at the flower-stalls in the Toledo, consisting of roses, ranunculuses, anemones, carnations, stocks, hyacinths, asphodels, &c. &c. Vegetation not farther advanced than we left it at Rome. Horsechestnut trees in the botanic garden with leaves one third expanded (March 6.), and on the same day a few buds of the common acacias in the Villa Reale unfolding.

ART. III. *Some Account of the Nursery Gardens and the State of Horticulture in the Neighbourhood of Philadelphia, with Remarks on the Subject of the Emigration of British Gardeners to the United States.* By Mr. WILLIAM WYNNE, Foreman in Bartram's Botanic Garden, Philadelphia.

Sir,

ACCORDING to my promise before I left England, I proceed to give you some account of the nurseries and gardens in the neighbourhood of Philadelphia, after having seen all of them worth looking at.

I shall begin with Bartram's Botanic Garden; the precedence being due to it, both for antiquity (it having been established 100 years), and from its containing the best collection of American plants in the United States. There are above 2000 species (natives) contained in a space of six acres, not including the fruit nursery and vineyard, which comprise eight acres. The handsomest and largest tree I have ever seen is here; it is a *Cuprèssus disticha* L. [*Schubèrtia disticha* of *Mirbel*, *Taxòdium distichum* of *Richard*], and is 120 ft. high: at 18 ft. from the ground it is more than 28 ft. in circumference, and it averages 28 ft.: it is 91 years old.* A *Gymnòcladus canadènsis*, or Kentucky coffee tree, is here 80 ft. high; an *Acàcia Julibríssin*, 35 ft.; an *Andrómeda arbòrea*, 75 ft.; an *Aràlia spinòsa*, 25 ft.; a *Gordònia pubèscens*, 50 ft., this tree is now in flower; and a *Diospýros virginiana* is 80 ft., and has a fine crop of ripe fruit on it, which tastes pretty well. The Americans distil an excellent brandy from this fruit. There are also two trees of *Magnòlia acuminàta* 80 ft. high, and six other American magnolias, from 40 to 60 ft. in height; with species of *Quèrcus* and *Pínus*, &c. &c., in great variety. Indeed, the most remark-

* I have seen an oak tree in Wynnstay Park, North Wales, that had a thicker trunk than the deciduous cypress described above, but was much inferior in height and symmetry.

able feature in this nursery, and that which renders it superior to most of its class, is the advantage of possessing large specimens of all the rare American trees and shrubs; which are not only highly ornamental, but likewise very valuable, from the great quantities of seed they afford for exportation to London, Paris, Petersburg, Calcutta, and several other parts of Europe, Asia, and Africa. This garden is the regular resort of the learned and scientific gentlemen of Philadelphia. A committee of the Horticultural Society closes an account of this nursery as follows:—"Mr. Carr, who deserves so much credit for the classification of his nursery, is no less entitled to praise for the admirable order in which his tool-house is kept; a place that, in most gardens, instead of possessing regularity, is made a mere lumber room. The best order is likewise preserved in the seed room, in putting up our native seeds. That apartment, moreover, contains a library of 400 volumes, in which are all the late works on botany and horticulture."

The next nursery, in extent and variety, is kept by Messrs. Landreth. Here are a good stock of green-house plants, orange and lemon trees loaded with fruit, and a remarkably fine Champney's rose. A good deal of the business of this nursery consists in growing vegetables for seed. They keep a seed-store in the city.

A Mr. Hibbert keeps a small nursery, in which he grows roses and other plants in pots, which he sells chiefly in the city market. I understand Mr. Hibbert has taken a piece of ground formerly occupied as a nursery by Mr. M'Mahon, and has taken into partnership Mr. Buist*, a gardener in the neighbourhood.

There is another class of gardens, very distinct from any I have seen before: those of plant-growers, who, to a small nursery, and green and hot houses, add the appendage of a tavern. The two principal ones of this description are kept by Mr. Arran and M. d'Arras: the first has a very good museum in his garden; and the latter possesses a beautiful collection of orange and lemon trees, very large, but trimmed after the French fashion. These places are the resort of many of the citizens; Philadelphia having no parks, or national gardens, for the purpose of recreation.

There are many small places in the environs of the city hardly worth noticing at present.

* Mr. Buist has recently visited England and Scotland, for, I think he said, the first time since he emigrated from Scotland, 14 or 15 years ago. He called at Bayswater in June, 1831, and evinced himself a man of much intelligence and professional ability. — *J. D.*

Peaches, pears, and apples, are the fruits most grown in this and the neighbouring states. Apricots and nectarines do not succeed, except in very fine seasons; the fruit being punctured by a species of *Curculio*, and dropping off about the time of stoning. Gooseberries do not succeed except in some few shady places; currants do very well. What surprised me most was the short duration of the peach trees, which seldom bear longer than from three to five years: they are attacked by worms at the root, and die soon after. The best remedy found out yet, is to keep a large stock of young trees always ready to plant in the orchards, when the others die. The inconvenience resulting from the short life of these trees is in great measure obviated by the facility with which a nurseryman can procure a young stock. There is now in this nursery above 2000 young and healthy peach trees, which will bear fruit next year: the stones were sown eighteen months ago; they were budded the following August, and are now from 6 to 10 ft. high, and are well branched and formed for standards.

Before I left London, several young gardeners begged of me to let them know what encouragement there is for such persons in this country. I know there are very erroneous opinions entertained by many regarding the subject of emigration to America. Some come here (I mean gardeners) with an impression that, although they know but little, they can easily impose themselves as "finished hands" on the Americans, who have not yet reached that high pitch of refinement which the British have. Now, Sir, I dare say you are aware that the Americans are a very matter-of-fact sort of people; and what with "guessing, calculating, thinking, and reckoning," they soon find out the pretender, and despise him accordingly. It is but justice to add, that the very best gardener may find some little difficulties in his way at first, from the spirit of rivalry which every thing British creates among the vulgar here. A great number of the American workmen's anecdotes are directed against the aristocratical bearing of Englishmen; nothing gives greater delight to the rustics than to hear of the Honourable D. S. or Lord John P. having been the last served, or badly served, at an inn, for being surly to the waiters, &c. &c. On the other hand, if the American workmen can drive a nail, or split a log, or row a boat, or shoot a bird with a rifle, a little more expertly than a European, they think they are superior in every thing; but they are much mistaken. They are, it is true, very active at desultory jobbing; but for constant and well-finished work, and gardening work too, I believe an American is as much inferior to an Englishman, as a Choctaw Indian is to the former.

Some Englishmen, who might be denominated good gardeners, are too sanguine of making a rapid fortune in America: they, of course, are disappointed. There are numbers who, from an aversion to study, and from other causes, affect to despise all "book learning" (as they call it), who, by dint of plodding the same round for a number of years, manage to scrape together a scanty knowledge of the routine of forcing, nailing wall trees, cropping ground, &c. &c.: to them I would say, if you want employment as a gardener, you had better seek for it at home, at least not here. Peaches are as cheap as 25 cents [about a shilling] per bushel; pine-apples from the West Indies from 5 to 15 cents [2*d.* to 6*d.*] each, and water melons cheaper: so that you perceive a mere forcing gardener would be like a fish out of water; the climate anticipates him in almost all the art he knows. A man who can procure a good situation in Britain, if he is fond of his profession, should not come here; except he can set up in business for himself, where he can find a ready market for any thing he can grow; but to the young gardener, who has studied the principles of his profession, who is not afraid of work, and who has not sufficient interest with the principal nurserymen to procure a situation worth his acceptance at home, to him I say, this is the country in which you can have plenty of employment, at wages on which you can live well.

Colonel Carr told me (with regret) that most of the European gardeners turned farmers soon after they came here. This speaks volumes. There are no American gardeners except amateurs.

I have not seen any princely palaces, and nearly as few wretched cottages. I have, it is true, seen one of the latter; but, being very free from prejudice, I will not, like Mr. Howden (Vol. VI. p. 657.), magnify it into thousands, neither will I insult its unfortunate inmates. By the by, I cannot help remarking that the law of primogeniture is (with all its monstrosities) the best friend of gardening. No such law exists in this country (the laws being here [as they ought to be, and finally will be, every where] all made for the benefit of the greatest number); and I know of nothing that feels the loss of this so much as horticulture. There is more than one instance, in the vicinity of Philadelphia, of fine houses and gardens going to wreck, from the individual of the family to whom they were left not being able to support the expense.

You have expressed a determination, in one of your last Numbers, to visit this land of freedom and plenty: I can assure you, that your readers here are highly delighted with the hope of seeing you. . . .

Should you deem the foregoing remarks worthy of a place in your much respected Magazine, you would oblige me by inserting them; and I shall from time to time furnish you with an account of the progress of gardening in this and the neighbouring states.

I am, Sir, yours, &c.

Bartram Gardens, Nov. 1831.

WILLIAM WYNNE.

OF Bartram's Botanic Garden on the Schuylkill, noticed in the preceding remarks, we have previously (Vol. VII. p. 665.) presented some interesting historical particulars. The above mention of the prodigious magnitude which the deciduous cypress attains in America, will render interesting some particulars to which we have access, on the characteristics of this majestic tree in its native forests; they are these:—"The cypress (*Cupressus disticha* L., *Schubertia disticha* Mirbel, *Taxodium distichum* Richard) is an important tree. It begins to be seen on the wet lands near the mouth of the Ohio, and is, with the swamp gum, the most common tree in the deep swamps from that point to the Gulf of Mexico. It is a tree of a very singular character. Under its shade arises a multitude of curiously shaped knobs, called cypress knees. These are regular cone-like protuberances, in height and circumference not unlike tall and tapering bee hives. The tree itself springs from a knob or knee of this kind, of an enlarged size, and, at the surface of the ground, of thrice the circumference of the proper trunk. This conical foundation of the tree rises of the height of from 6 to 10 ft.; and from its apex towers the main trunk of the tree, with scarce any diminution in its circumference, for a length of 60 or 80 ft." But we must leave Mr. Flint to pursue the account in his own words:—

"Very near its top, it begins to throw out multitudes of horizontal branches, which interlace with those of the adjoining trees; and, when bare of leaves, have an air of desolation and death, more easily felt than described. In the season of vegetation, the leaves are short, fine, and of a verdure so deep as almost to seem brown; giving an indescribable air of funereal solemnity to this singular tree. A cypress forest, when viewed from the adjacent hills, with its numberless interlaced arms, covered with this dark brown foliage, has the aspect of a scaffolding of verdure in the air. It grows, too, in deep and sickly swamps, the haunts of fever, musquitos, moccasin snakes, alligators, and all loathsome and ferocious animals, that congregate far from the abodes of man, and seem to make common cause with nature against him. The cypress loves the deepest, most gloomy, inaccessible, and inundated swamps; and south of 33° is generally found covered with the sable festoons of long moss, hanging, as it seems, a shroud of mourning wreaths almost to the ground. It seems to flourish best where water covers its roots for half the year. When the water rises from 8 to 10 ft. from the overflow of rivers, the apex of the tree's buttock is just on a level with the surface of the water. It is then, in many places, that they cut it. The negroes surround the tree in *periogues*, and thus get at the trunk above the huge and hard buttock, and fell it with comparative ease. They cut off the straight shaft, as suits their purpose, and float it to a raft, or the nearest high grounds. Unpromising as are the places and the circumstances of its growth, no tree of the country where it is found is so extensively useful. It is free from knots, is easily wrought, and makes excellent planks, shingles, and timber of all sorts. It is very durable, and incomparably the most valuable tree in the southern country of this valley. It is a fortunate circumstance, that it inhabits the most gloomy and inacces-

sible regions, which will not come into cultivation for ages. It will, of course, have a better chance, not to share the fate of the most useful timber on the valuable uplands. The improvident axe soon renders timber difficult to be procured, in a country in the centre of forests. All the cypress forests, however, that are easily accessible, on the Lower Mississippi, and its tributaries, have been stripped of their timber by the Mississippi lumberers, who have floated to New Orleans millions of feet of this timber, from the lands of the United States, and who have already created a scarcity of this species on the margin of the Mississippi. There are, however, in the vast swamps of the Mississippi, Arkansas, Red River, and Florida, inexhaustible supplies of cypress still remaining.'” (*Flint's Geography and History of the Western States*, vol. i. pp. 62, 63.)

Cypress trees, the roots of which present similar appearances on a less scale, may be seen in the Duke of Northumberland's grounds at Syon, at Blenheim, and various other places in England, and in the grounds of the Petit Trianon, in the neighbourhood of Paris.— *Cond.*

ART. IV. *Notices of some of the principal Nurseries and private Gardens in the United States of America, made during a Tour through the Country, in the Summer of 1831; with some Hints on Emigration.* By Mr. ALEXANDER GORDON.

Sir,

HAVING performed another trip to the United States of America, I beg leave to offer a few remarks on the state of gardening in that delightful country. During my tour in the years 1827 and 1828, it was impossible for me to visit so many of the horticultural establishments as I wished; but I have, during my last visit, extended my observations much farther: and, in the hope that they may be gratifying to the readers of this Magazine, I now avail myself of a few leisure hours to arrange them for their perusal.

Gardening, in the United States of America, can never arrive at that degree of perfection which it has done in England: the nature of the American government makes this utterly impossible. The abolition of entails, and the repeal of the law of primogeniture, naturally break down into small portions the estates of even the greatest landholders. It is no uncommon circumstance in America to find lands, formerly held by one proprietor, now divided into forty or fifty parcels, belonging to as many different persons; so that gardening, to any considerable extent, by individuals, cannot be carried on in the same manner as if those possessions were concentrated in the hands of one person. The moment the proprietor dies, his land is equally divided among his children; and, by thus falling into many hands, no one has the means, if he had the inclination, to keep a garden in the manner, and to the extent, which is done by English noblemen and gentlemen. Still, this may be remedied, by uniting, and forming

public gardens; the only method by which gardening can arrive at perfection in the United States. I will here add, it follows as a natural consequence, that America is not the proper field for one of our first-rate serving gardeners; and the individual who emigrates to that country must prepare himself for a life of the most strenuous exertion, if he hopes to succeed. But, although this may retard the higher branches of gardening, God forbid I should be considered for a moment as objecting to the system! No: I have seen too many proofs of its efficacy in rendering a whole people independent, comfortable, and happy. Having alluded to these drawbacks to gardening, justice compels me to state, that its progress, under such circumstances, is most astonishing, and wonderful in the extreme. The many flourishing establishments now in existence in the United States are a convincing proof, if proof were wanted, of its wonderful rise and progress. Having visited the greater part of these establishments, I shall now proceed to make a few remarks on each; only premising that I by no means mix myself up with some angry discussions among the American nurserymen, formerly inserted in your Magazine. I received a kind and generous reception from all, and can, therefore, have no reason to deviate from a true statement of facts.

The following establishments are arranged in the order I visited them: —

The Messrs. Thorburn, Seedsmen, in the centre of the city of New York, have much improved their establishment since my last visit, and made considerable additions to their extensive collection. The first circumstance which attracted my attention, on entering their gate, was the wonderful luxuriance of the georginas. Those marked in our lists as growing only 3 ft. and 4 ft. high, I found there 6 ft. and 7 ft., and proportionately large and fine in every respect; chrysanthemums equally luxuriant. To the interior of Messrs. Thorburn's seed-store I feel myself incompetent to do justice: its admirable arrangement and most extensive collection of seeds, and its library and most numerous decorations, connected with its great extent, render it decidedly the most complete seed-store or seed-shop I have ever seen. The spacious green-house in front of the stove was remarkably well stocked with a splendid collection of plants, which would have done our first-rate plant-growers the greatest credit. The local situation of this establishment, its display of a regular succession of the choicest beauties of Flora, and the free access to it by the public at all hours, have, in my opinion, done wonders in accelerating the progress of gardening in the United States. It cannot be expected that the senior of this firm, when he

first established it [see Vol. IV. p. 275.], was a good judge of seeds; but he has, by his industry and application, arrived at a thorough knowledge of the subject: and his exertions are wonderfully seconded and forwarded by his son, Mr. George Thorburn, whom I found every gardener and botanist in America to speak of in the highest terms.

Mr. Smith, Mr. Wilson, and Mr. Kenny have seed-stores in New York. Mr. Wilson's I did not visit; but I was informed that this gentleman has also an extensive nursery and garden for the growth of fruit trees and culinary vegetables, though my arrangements prevented me from visiting it: an omission which I shall rectify, this summer, on my return.

The Establishment of Mr. Hogg, at Bloomingdale, had undergone a most material improvement since my last visit; particularly in the extensive addition made to his hot-houses and pits, and in the vast number of new, rare, and valuable exotics he has added to his admirable collection. Those who were acquainted with this gentleman's superior knowledge of plants when in this country, may rest assured there is no falling off since he has crossed the Atlantic; and I was truly happy to find he stands high in the estimation of every gentleman with whom he is acquainted.

Mr. Floy's Nursery. — The rage for building about New York has considerably circumscribed the grounds of this establishment in the vicinity of the city; but Mr. Floy has purchased a piece of land at Harlem, which he has converted into a nursery; and which, from the different soils it contains, is peculiarly adapted for the various tribes of fruit trees and plants with which his establishments are so richly stored. Mr. Floy has been very successful in originating some most splendid varieties of new camellias, of which I saw the figures; I believe the different varieties have been sent to this country, and will therefore soon find their way into the English collections.

Mr. Bridgeman has a small nursery and seed-store in this vicinity; but not having sufficiently examined it to make myself fully acquainted with its details, I decline giving a partial, and probably unjust, statement of its contents.

The Linnæan Botanic Garden is the property of the Messrs. Prince, at Flushing, Long Island. Of this establishment much has been said, and much has been written. Its extent, the great variety it contains, the multiplicity of agents employed for collecting and disseminating plants for and from it, and the assertion of Mr. Prince, jun., to myself personally, that no man in England, with the exception of yourself and Mr. Robert Thomson of the London Horticultural Society,

were at all competent to do his establishment justice, of course makes me approach the subject with some degree of diffidence. That this establishment contains a most various and extensive collection of plants is beyond all question; but most certainly it does not warrant the statement [Vol. II. p. 90.] that it is more extensive than all others in America combined together.

I spent several hours in going over the establishment; and certainly candour demands the statement, that, taking it as a whole, it is not equalled, most certainly not surpassed, by any other nursery which I visited. In particular departments it is excelled by several; in others, it surpasses any; but I must acknowledge the green-house plants are not near so well grown as when I had the pleasure of seeing them in December, 1827. I hope Mr. Prince will view with indulgence this statement, because I am conscious I am correct. I earnestly begged of Mr. Prince to visit the European nurseries; it would dispel a delusion, under which he evidently labours, as to their extent, and the variety they contain. Having said thus much, it is but fair for me to state that I saw much, very much, to approve; and, no doubt, had my visit been prolonged, I should have seen much more. Mr. Prince's collection of vines is most extensive*; and his American plants are numerous and various, including splendid specimens of magnolias and various other forest trees. The Messrs. Prince are most indefatigable in their exertions to procure all foreign and native plants; and my intercourse with different gentlemen, in various parts of the United States, afforded me ample proof of this fact. By the by, if I found a falling off in the cultivation of the green-house plants, I found an equal improvement in the arrangement of the grounds; and I hope, when you visit America, that you will devote as much time as you can spare to exploring this garden.

The Establishment of "James Bloodgood and Co." is about a mile from Flushing, and contains a good collection of ornamental trees, evergreens, flowering shrubs and plants; with decidedly the best-grown fruit trees I saw in America. This remark I made to many of the nurserymen when there; and as I never before, nor since, have had any communication with these gentlemen, my observation cannot be guided by any partiality. The extent of their nursery is, I think, about 12 or 15 acres, closely cropped with fruit trees, &c.; and, it being an oblong rectangle, the trees are so arranged that they plough between the rows, from side to side, directly through the different quarters, several times during the summer; thus saving a great deal of manual labour. One point which

* He has published a work on the vine.

Messrs. Bloodgood and Co. practise, I think, deserves general imitation in America; viz. I saw a cellar, in which were a great number of fruit trees that had been recently taken from the ground, and closely planted in sand (laid in by the heels, as it is called in the London nurseries), which enables the proprietors of the nursery, during the severest frost, to execute foreign orders, and orders for the Southern States.

The original Tree of the Newtown Pippin.—On leaving Flushing, I called at the residence of Mrs. Col. More, 3 miles nearer New York, to see the original tree of the celebrated apple called the Newtown pippin. I found it growing in the centre of an old orchard. The tree divides itself about $2\frac{1}{2}$ or 3 ft. from the ground; but, although the estate has been in the possession of Col. More's family for two centuries, they were unable to give me any account of its origin; consequently the tree must be of very old standing.

These are the principal nurseries about New York, with the exception of Mrs. Parmentier's, at Brooklyn, also on Long Island, of which you have recently [p. 70–72. of the present Volume] published a particular account: a repetition by me would therefore be useless; so I proceed to Albany. A son of Mr. Thorburn's of New York has recently opened an establishment here in the seed line; but, being only in its infancy, it would be premature to form an opinion of it.

The Albany Nursery.—About 3 or 4 miles from Albany, your most enlightened and scientific correspondent, Judge Buel, some years ago commenced the nursery business, in company with a gentleman of the name of Wilson, who is a very superior practical gardener; and, for the short period which has elapsed since their commencement, they have done wonders. There is a great diversity of soils in this nursery, which the proprietors are turning to good account; by planting the different species of trees to be propagated, in the soils most suitable to their respective habits. No expense is spared in procuring every desirable novelty from Europe; and, when we take into consideration the scientific knowledge of Judge Buel, and the practical experience of Mr. Wilson, with the local advantages they possess, and their spirited exertions, we may presume the Albany Nursery will at no distant day be among the very first establishments of the kind in the States.

From New York to Albany, I found on the banks of the beautiful river Hudson (a noble stream, accompanied by scenery of the most sublime, picturesque, and romantic character, not surpassed for variety and grandeur by any in the world) the remains of some ancient manor houses formerly possessed by great proprietors, chiefly by the Livingston family,

which name still predominates in that quarter. The mansion of John Swift Livingston, Esq., is situated in one of the most beautiful locations on the Hudson. Attached to the splendid brick mansion of R. L. Livingston, Esq., is a large hot-house, well stocked with choice plants. Captain Brown, of the United States' army, has also a neat delightful residence in this vicinity: there is a small grove in front, which is decorated with a beautiful arbour; and a number of rustic seats are placed around the trees in the ground.

There is an immense number of gentlemen's seats situated on the banks of this beautiful river; but, as it respects gardening, every thing about them is on a confined scale, for the reasons stated at the beginning of this article; and although the remains of the possessions of the old aristocracy were visible, yet the ancient manor houses were falling to decay; the trees of the parks and pleasure grounds were all neglected; and rank grass and weeds covered the walks, &c.

Hyde Park, on the Hudson. — As an exception to this forlorn state of former greatness, or rather former extent, I can, with the greatest propriety, mention the splendid mansion and seat of Dr. David Hosack, a gentleman well known in the literary and scientific world [the Sir Joseph Banks of America]. The doctor has lately retired from business and the city, to this delightful spot, Hyde Park. Our Hyde Park, on this side the water, can bear no comparison with its namesake on the other side of the Atlantic; its natural capacity for improvement has been taken advantage of in a very judicious manner; every circumstance has been laid hold of, and acted upon, which could tend to beautify or adorn it. The park is extensive; the rides numerous; and the variety of delightful distant views, embracing every kind of scenery, surpasses any thing I have ever seen in that or in any other country. I had the pleasure of riding round the whole with its most amiable owner, than whom a more condescending and affable gentleman is not in existence. The pleasure grounds are laid out on just principles, and in a most judicious manner; there is an excellent range of hot-houses, with a collection of rare plants; remarkable for their variety, their cleanliness, and their handsome growth. The whole of this department is under the care of Mr. Hobbs, an English gardener, who well understands his business; and it was most gratifying to me to find Dr. Hosack so justly appreciating his merits. The farm buildings have been recently erected; and their construction and arrangement deserve the strongest praise; but in fact, every thing connected with Hyde Park is performed in a manner unparalleled in America; at least, as far as my observations extended.

I might enumerate a great many more places here ; but, as I found nothing particularly remarkable, I proceed at once to Philadelphia, making only an exception of the seat of the Count de Surveilliers, elder brother of Napoleon Bonaparte, and formerly King of Spain. His seat is near Bordentown, in the state of New Jersey, where he has effected great improvements, and is now actively employed in others ; consequently, the place is in an unfinished state at present. It is most gratifying to see this amiable nobleman withdrawing himself from the busy scene of politics into retirement, and expending his princely fortune in rural improvements.

When at Philadelphia, I had an opportunity of attending the meeting of their horticultural society. A regular routine of business was gone through, and several things exhibited ; various foreign communications were read, one of which, from the East Indies, was soliciting, in the strongest terms, a reciprocal exchange of plants, &c. The whole of the proceedings were conducted in a manner which, if persevered in, must be highly conducive to the furtherance of gardening and botany. The secretary, Dr. Pickering, to whom I was introduced, is, I understand, a most scientific and enthusiastic botanist, and uses the most strenuous exertions for the advancement of that science. I first called at the nursery of Hibbert and Buist. The latter-named partner had visited England and Scotland during the summer of 1831 [see p. 273. note], and had taken back an extensive collection of plants from both countries ; which, in part, went tolerably well, though a great many died during the voyage. He and myself sailed from London on the same day, but in different vessels. I allude to this, with the intention of directing the attention of those who are in the habit of sending plants abroad. We both had large collections of Chinese, Cape, and Botany Bay plants, principally packed in matted baskets ; and the voyage being long (seven weeks), they suffered severely, notwithstanding our most assiduous attention and care. I had with me a basket of choice pelargoniums, of which I expected to save very few, but I did not lose one. For the sake of experiment, I took from a respectable London nurseryman, Mr. Dennis, King's Road, Chelsea, a quantity of the same tribe, with the mould shaken completely from the roots, and packed them with dry Sphágnum in a fish basket, which I placed at the mizen-mast head : after we had been six weeks at sea, I was desirous to examine the result ; when I found every one alive and healthy. In repacking them, I suppose I was not sufficiently careful ; for, a week afterwards, I found them all dead : but I highly approve of the plan. As it respects sending

plants generally, I consider, that, if packed in clean boxes, and in moist Sphágnum, they have decidedly the best chance of going safe. I have had the most convincing proofs of the efficacy of this plan. [See Judge Buel's suggestions for packing plants destined for America, Vol. VII. p. 441—443.]

The Nursery of Hibbert and Buist is in the city of Philadelphia, and is principally dedicated to the cultivation of exotics and free-flowering shrubs and plants in pots; but they have recently purchased the grounds formerly occupied by M'Mahon (I believe the first American writer on gardening); and I have no doubt, with their practical knowledge, and strict attention to business, they will meet with ample encouragement from the spirited inhabitants of Philadelphia. The plants looked remarkably well, with the exception of those which Mr. Buist had, only a few weeks previous, brought over.

The Nursery of Messrs. Landreth & Co.—The grounds are well stocked with a most excellent collection of fruit and forest trees, all grown in the greatest perfection. There are some very fine trees, *Magnòlia macrophýlla*, and other choice American forest trees, with a good range of glass houses, containing some very rare exotics, and all grown in the greatest perfection. These gentlemen have an extensive seed-store in the city of Philadelphia, from which they send a great many seeds into the northern as well as into the southern states. It is very common, throughout the Union, to see on signs, and at the heads of advertisements, "*Philadelphia and English Seeds.*"

The grounds of Colonel Carr, called *Bartram's Botanic Garden*, have been described in a recent Number of this Magazine [Vol. VII. p. 665.], by your talented correspondent, J. M.; but I think he has not dwelt sufficiently on the most superb specimens of the various American trees to be found in this garden. [See p. 272. of the present Number.] I declare I should consider a journey of 500 miles well spent, solely to see them, and I sincerely regret having mislaid my memoranda made of their names and sizes: but, if I live, six months shall not expire before I have furnished you with all particulars respecting them. They deserve to be recorded as an eternal memento of the spirited exertions of the elder Mr. Bartram, they being the fruits of his researches and exertions. The collection of American plants will equal any in the States. There is a most excellent collection of the genus *Cactus* in this nursery, among which are many new species recently imported from South America, and not yet described. The house plants were well grown; there were some very fine fruit trees; and the whole concern seems to be carried on in a spirited manner by the present proprietor, who, I understood

from many gentlemen during this and my former tour, is a most honourable-dealing man. He showed every attention to me during my stay at his nursery, which I regret was so limited, as I am conscious many rich gems must have escaped my observation.

The gardens round Philadelphia are apparently neatly kept. I saw some which were laid out with great taste, and well stocked with choice plants. That of Mr. Pratt, about four miles from Philadelphia, has long been noted for its choice collection of plants. It was there Pursh made his first attempt at collecting the American flora; and his exertions were amply rewarded. I trust it will not be deemed presumption in me to state, that, although I consider his work of the greatest utility, as it respects American botany, still it abounds with errors, particularly with regard to the plants of the southern states, part of which Pursh never visited; Georgia (although so rich in plants), for instance. I will not say more upon the subject; but at some future day, when I have reaped more experience, I may send you some corrections.

I returned from Philadelphia to New York, and thence again to Albany; but, on the 1st of December, hoary winter appearing in his rigorous hue, I bent my way to the south, and landed in Charleston, South Carolina, on the 7th. The last few years have wonderfully changed the features of gardening in Charleston; and the number of botanists to whom I was introduced was a convincing proof that this delightful science is duly appreciated in that beautiful city, while the surrounding country furnishes them with ample resources for their exertions. There are two seedsmen in Charleston, Mr. James Wilson, and a relation of the Messrs. Landreth of Philadelphia. The only nurseryman is M. Noisette, brother to the celebrated nurseryman of that name at Paris. But for me to describe the beautiful specimens his ground contains would occupy a whole magazine. Camellias 16 and 20 ft. high, and 20 ft. in circumference; a most splendid *Cycas revoluta*, at least 20 ft. in circumference, in the open ground, with all our plants of the same nature and habits in equal proportion. I cannot pass over some beautiful specimens of the Noisette rose. I venture to assert that few, if any, ever saw such beautiful specimens of that excellent variety of that delightful genus as are in this garden: but I must drop the subject; I am not competent to do it justice. This garden must be seen to be duly appreciated. M. Noisette has a most thorough knowledge of the plants in the southern states; and there are many varieties, strangers to our gardens, which it would be highly gratifying to possess, and which few but himself can furnish. His indolence in this respect is most unpardonable.

Were not M. Noisette my warmest friend, I would not be so severe, but I am confident he will attribute my severity to the real cause.

Mr. Legaré, the editor of the *Southern Agriculturist*, is most indefatigable in his exertions, and has done much by example, and by his most useful publications, in forwarding the science of horticulture in the southern states. His correspondence with Mr. Charlwood of London will, I am confident, be the means of introducing many new vegetables to that part of America, where they are much wanted; for I have met with gentlemen in the south who *never saw a cauliflower*. I was most happy to find the gardens around Charleston in a very flourishing state: many new vegetables have been introduced since my last visit; and, considering the short period which has elapsed, the progress made is wonderful.

At Savannah, State of Georgia, as before, I found the garden of Thomas Young, Esq., to surpass all others in the south. It is rich in the most choice and most expensive plants that can be obtained. This most worthy gentleman spares no expense in obtaining every plant which will succeed in that climate; and, in a few years, his garden will surpass even his own most sanguine expectations. The genera *Amaryllis*, *Panocrätium*, and *Crinum* succeed admirably in the open air here; and Mr. Young has commissioned me to bring him from England as many of those delightful plants as I think proper. Mr. Young's garden is as numerously frequented as that of our great national Horticultural Society at Chiswick. As it respects gardening, he is a host within himself; his example is doing wonders; he is a purchaser of all your works, and wishes anxiously to see the author.

Mr. Oemler of Savannah is a great amateur in gardening, and a most excellent botanist; the late Mr. Elliot of Charleston, the editor of the *Botany of South Carolina and Georgia*, frequently mentions the kind assistance of this gentleman; and also of two other gentlemen, Lewis le Conte, Esq., and his brother, Major le Conte, of the United States' army: than whom there are not two more scientific gentlemen in the United States of America. The assistance I received from these gentlemen, in making my collection of plants, I cannot give you the most distant idea of. They are most excellent botanists, and naturalists in every branch of science; and I hope to prevail on Major le Conte to become a contributor to your *Magazine of Natural History*. He is now publishing a work in Paris on the lepidopterous insects of North America, which I hope you have seen.

The Garden of Lewis le Conte, Esq., near Riceborough, in

Liberty County, Georgia, forty miles south of Savannah, is decidedly the richest in bulbs I have ever seen; and their luxuriance would astonish those who have only seen them in the confined state in which we are obliged to grow them in this country. M. le Conte has discovered many new plants; and through his kindness I have been enabled to enrich our collections with some splendid treasures. This gentleman has, for above thirty years, given his attention to the successions of the different species of timber, as alluded to by your excellent correspondent, J. M. of Philadelphia [Vol.V. p. 421.]. As I consider M. le Conte's ideas on the subject highly deserving of attention, I insert them *verbatim*, as I noted them down when on a visit to him in January last: —

“The pine lands in the southern states have generally old oak grubs, which, by reason of the periodical fires, are prevented from becoming trees; notwithstanding, they still continue alive: and when land is turned out (that is, when the cultivation of land is relinquished), pines, being by nature unproductive of suckers, are consequently killed *in toto*; while the oak, now sole possessor of the soil, starts up, and grows vigorously. On the other hand, land which had been solely occupied by oaks previously to its cultivation, is invariably of a superior quality to what is termed *pine lands*, and naturally is a longer period under cultivation before it is turned out; by which means the roots of the oaks are completely eradicated while it is in a state of cultivation. The pine seeds being winged, and thereby easily carried by the wind to a considerable distance, if the ground is free from the roots of other trees, are the first to establish themselves; and, being of a free and rapid growth, they take the lead of all other species of timber, and become the principal occupiers of the land: but when the roots of the oaks are *not destroyed*, they will take the lead, and resist the pine and other trees. All pine lands which originally had no oaks will invariably produce pines again, whether they have been under cultivation for a long or a short period.”

These remarks are the result of thirty years' close observation, and, consequently, are correct; but I find, on referring to my notes, that M. le Conte adds, as a hypothesis respecting the succession of wild cherries to beech, &c., “that birds, being naturally fond of the cherry, eat them with avidity, and swallow the stones of the fruit, which do not suffer, in their germinating qualities, while in the bowels of the bird; and as these frequently resort to beech woods, it naturally follows that they void these cherry-stones there; which either lie dormant (as they retain their vegetating powers for a length of time), or germinate and remain in a diminutive state: but

when the beeches are cut down, they advance rapidly, and become the principal occupants of the soil." (Jan. 29. 1832.)

I have a vast fund of information on many interesting subjects, obtained from M. le Conte; but must let the above suffice, as I find I am extending this article to a great length.

I must, however, inform you that this gentleman thoroughly convinced me of the existence of the *Magnolia pyramidata*; for on Thursday, the 27th of January, we took a journey of fifty miles, and crossed the Altamaha river, to look for a tree of that species which M. le Conte had seen there eighteen months previous. We found it; and it evidently differs from the *M. auriculata*, the leaves being only from 5 in. to 6 in. long, and the sinus at the base more abrupt and angular; with the buds more elongated and more acuminate: to all appearance the leaves were glaucous underneath, though when we saw them they were withered. Elliot's description of the tree is quite correct. Pursh's is as follows:—

M. foliis rhomboideo-obovalibus, abrupte acutis, concoloribus, basi subcordatis, auriculatis, lobis divaricatis, petalis lanceolatis, sensim acutis. But it ought to be, "*Foliis obovatis, abrupte acutis, subtus glaucis, basi subcordatis, auriculatis, lobis non divaricatis, petalis*—of course, I did not see.*

Before I conclude this sketch of the gardens of America, I must assure you that I sincerely regret I never have had the opportunity of visiting Boston in the State of Massachusetts; where, I understand, the science is in a more forward state than in any other part of the Union. I hope soon to be able to satisfy myself, and also your readers, on this subject.

I have, early this morning, read and re-read your article in the April Number of the Gardener's Magazine, wherein you recommend gardeners, in the strongest terms, to emigrate to the United States; on which subject I beg leave to advance a few observations.

Emigration is attended with many inconveniences, which few are competent to appreciate but those who have experienced the trial: leaving their native countries, their relatives, and their former homes, to go to a foreign country, where every thing is strange, and where they have to adopt new manners. A new system is of itself a severe trial; but, Sir, I am sorry to add, too many emigrants are of a class not calculated to do well in any country; and, for them, America is the worst country in the world, as you will find no individual there, however high or exalted his station, who is not actively engaged in some pursuit. † No man can hope to prosper who

* Since writing the above, I have seen the *M. pyramidata* in Mr. Lee's nursery at Hammersmith.

† Your assertion respecting the price of living in the United States is

does not exert himself to the utmost. Fine gentlemen had better stay at home; but, on the other hand, any individual may do well who goes there, and who is *sober*, industrious, and persevering. If he purposes remaining in the States, he should by all means enrol himself a citizen as soon as he arrives, as otherwise he can hold no landed possessions: he should on no account remain long (unless he be a mechanic) about the city where he may land. I speak from experience.

I am, Sir, yours, &c.

Leicester, May 7. 1832.

ALEXANDER GORDON.

ART. V. *On certain Frauds imposed by Correspondents upon the Readers of Transactions of Horticultural Societies, and of the Gardener's Magazine, &c.* By AN ENEMY TO DECEIT.

Sir,

I HAVE been intending, for some time past, to write to you concerning a species of fraud, imposed to a considerable extent, by correspondents, upon the readers of *Transactions* of horticultural societies, and those of the *Gardener's Magazine*. I have deferred writing to you upon this subject, expecting that some one better qualified than myself would come forward, and bring it before the attention of you and your readers. In this, however, I have been disappointed; no one, so far as I know, has so much as hinted at its existence; and, from the importance of the subject, I feel myself compelled to perform a duty, which should have been, and I truly wish it had been, discharged by the correspondents themselves. As I do not approve of a caviling disposition, I would much rather join in congratulation, or remain altogether silent, than expose faults; but there are some things about which to say nothing, amounts to nothing less than crime.

There are some, and I trust many, of your correspondents who really deserve the commendation and gratitude of your readers. The humble and candid, yet expressive, manner in which they have disclosed their sentiments, fully evinces these to be dictated by the best of motives, as well as to be the result of much experience and investigation: for my own part, I have been, and I hope still shall be, delighted and instructed by their communications. But there are others, who,

perfectly erroneous: no man can board and lodge there under $2\frac{1}{2}$ or 3 dollars per week. — *A. G.*

Our statement was made on the authority of Mr. Benjamin Poor, of New York, who lately, with his family, passed some months in Europe, and several weeks in London. — *Cond.*

judging from their present practice, seem not to have been actuated by such laudable intentions. These persons, apparently from an ostentatious desire of bringing themselves and their plans before the public, or from some other mean design, have set forward, as a great acquisition to the horticultural world, the result of some experiments intended to set aside established methods of practice; but, being unable to substantiate their discoveries by reason, they are often obliged to appeal to their own success, or to what they choose to call undisputed facts. The language, too, is sometimes peculiar, and savours not a little of presumption. You may observe in almost every instance, the participles "convinced" and "converted," preceded by determinate adverbs in the superlative degree, such as "most fully," "most completely," or "most decidedly." These practices, although bad enough, are, I am sorry to say, only precursors to one infinitely worse; for the communications, not being fixed upon solid bases, must give way to after experience: and accordingly we often find the very projectors themselves returning to the plans their ingenious communications were intended to supersede. I know several whose present practice actually gives the lie to their self-sufficient papers. Some persons with whom I have conversed upon this subject, assert their knowledge of similar cases; and from this I conclude that such instances are by no means uncommon. But have any of them had the honesty to publish their discontinuance of practices which they have found untenable, in order to prevent others from adopting their plans, at the risk of much trouble, expense, and disappointment? No: not a single instance has appeared. To speak about the impropriety of such conduct would be useless; its inconsistency and injustice must be evident to every one.

I do not wish you to suppose that I write in this manner without sufficient facts to prove my statements. I could give you several; but one example will suffice at this time, and I will leave the rest to some other opportunity: in the mean time hoping the authors will save me the trouble, by confessing it themselves where their plans have failed: as, if they do not, I shall take the liberty to do it for them. For the example I refer to, I must first invite you to turn to Vol. I. p. 70., where you have abridged a paper from the *London Horticultural Society's Transactions*, on the growing of pines without bottom heat, communicated by Mr. Stewart, gardener to Sir Robert Preston, Bart., Valleyfield, near Culross, Perthshire. Mr. Stewart says he is "fully convinced of the efficiency of his method, after three years' experience." He wishes, also, that his experience may in some degree tend to establish

Mr. Knight's theory. Without passing one remark upon his paper, I shall briefly state what is his present practice, leaving your readers to judge for themselves.

At Valleyfield there are two fruiting pine-pits, one wrought with leaves, with as much tan as will allow the pots to be plunged in it, and a fire flue; the other by leaves, and dung linings. The succession pit is wrought by leaves, dung linings, and a fire flue. The remaining pits are those in question. They remain still of the same construction; but, instead of setting the plants on sand, Mr. Stewart now plunges them in 15 in. of good tan, by stirring, watering, and often renewing which, he fails not to keep up as strong a bottom heat as the most rigid advocate for bottom heat pine-growing could desire. These pits are chiefly used for small succession plants, crowns, &c. I can also assert that Mr. Stewart never raised a pine worth any thing during the time he adhered to his own method; and that he was obliged, from absolute necessity, to return to the old system. I assert this upon good authority, and without any fear of contradiction.

To do justice, however, to his improved mode, I must not omit to mention that it is excellent for producing, and rearing to full perfection, that friendly neighbour of the pine, the white scale. Mr. Stewart was, at any rate, "fully convinced" of this, before he relinquished it. Mr. Stewart, for changing his practice, cannot urge the plea of convenience, for he has plenty of coals within half a mile, and sand in abundance within a hundred yards of the pine pits; whereas he has to drive his tan a distance of seven miles. Any of your readers who, from experience or observation, may have discovered similar cases of discrepancy, would do well to make them known; as by this means only we possess the power of limiting the extent, and neutralising the effects, of these deceptions.

I am, Sir, yours, &c.

Staffordshire, April 17. 1832.

AN ENEMY TO DECEIT.

KNOWING the author of the above communication, and that he worked for some time in the gardens of Valleyfield, and believing him to be candid and honest, we have inserted his "instance." As to the principle on which his paper is founded, its correctness is undeniable; and we have said so in one of our earlier volumes. (Vol. II. p. 439.) A magazine has this great advantage over collections of papers in what are called *Transactions*, that it admits of controversial discussion, which the latter do not; and therefore false doctrine, once admitted into such collections, stands there as true. In this respect, the *Transactions* of societies, in their present form, and in their present manner of publication, are behind the age. Fortunately the bulk and expense of these works prevent them from being generally read; for, if they were, they would, in cases similar to that referred to by our correspondent, often do more harm than good. — *Cond.*

ART. VI. *Plan for heating Hot-houses by the Circulation of hot Water in hermetically sealed Tubes of small Diameter.* By Mr. A. M. PERKINS.

Sir,

I BEG leave to submit to your judgment my plan for heating hot-houses by circulating hot water in hermetically sealed tubes of small diameter. In the infancy of this plan, in consequence of my successful application of it to the heating of the printer's plates in the Bank of England, John Horsley Palmer, Esq., the governor, very liberally proposed to erect an apparatus in one of his hot-houses, with a view to ascertain its powers for heating it. I therefore put up an apparatus, consisting of a series of pipes, of only an inch in diameter, so connected together as to form a complete circuit round the house; one fourth part of these pipes, in the form of a coil, was placed in the flue of a fire-brick furnace, of a peculiar construction [see *figs.* 44. to 46.], and the other three fourths were exposed to radiation within the house. The result was a gradual rise in the thermometer, in the house, from 45° to 90° in four hours, without once stoking the fire from the time of lighting. The fuel was coke. This experiment effectually proved the power of my apparatus, with respect to the transmission of heat. Subsequent experiments have proved its capability of sustaining an equality of temperature for ten hours together, without the attendance of the stoker.

Mr. Palmer has since had three other houses heated in the same manner, which, he assures me, give him unqualified satisfaction. With respect to the economy of fuel, there appears a great gain over the ordinary flues. When the fuel used by my apparatus is compared with that consumed in Mr. Palmer's conservatory, he says, there is a saving of two thirds.

These facts completely refute the objection raised by some persons against the use of small tubes for heating hot-houses, &c., as they incontestably prove the power possessed by my apparatus, notwithstanding the small quantity of water used, of absorbing the heat from the furnace, in such equal and constant quantities, as to compensate for the greater quantity of water used upon the old system of large cast-iron pipes. There is an advantage also in the small pipes employed in the hermetically sealed system, which does not belong to the larger pipes; and that is, from the furnace being the magazine of heat, and situated outside of the house, the heat can be reduced in much shorter time, by simply opening the flue-

doors; and, on the other hand, the temperature, in the same proportion, can be as quickly raised in case of sudden frost, or discovery of the neglect of the gardener.

I beg to observe, that, from notes taken for a month together, by Mr. Palmer himself, on a Sikes's self-registering thermometer, there did not appear, at any one time during the night, a variation of more than $2\frac{1}{2}^{\circ}$, and very often not one degree, although there were at times 7° of frost out of doors.

This furnace will burn the hardest stone or Welsh coal.

I am, Sir, yours, &c.

A. M. PERKINS.

*London, 21. Great Coram Street,
Brunswick Square, March 15. 1832.*

THE gardening world are much indebted to Mr. Palmer for his liberality and public spirit in risking the application of this new mode of heating, on an extensive scale, in his hot-houses, at Parson's Green, near Fulham, Middlesex. We have before noticed (p. 236.) that we examined these hot-houses, talked with the gardener on the subject, and were much satisfied with the plan. Mr. Perkins has since applied his mode of heating to our small hot-house at Bayswater, and to a green-house connected with it, with the most complete success. The great advantage of the mode, as applied to hot-houses, is the economy in the first erection. Messrs. Walker, who, as we before observed, are the manufacturers of Mr. Perkins's apparatus, state that this, in most cases, will amount to one third of the expense of heating by hot water, according to any of the common modes. With respect to the power of the one inch tubes, it has been demonstrated, by a mathematician and chemist of the very first authority, that as much will be effected by one of Mr. Perkins's one-inch tubes, heated to 300° , as by one of the three-inch tubes, employed in any of the ordinary modes of heating by hot water, when heated to 180° . A second advantage of Mr. Perkins's mode, for hot-houses, is the small space which the pipes occupy; and this, for houses which have not been built expressly for being heated by hot water, is no small matter. A third advantage is, that the water may be circulated, without regard to whether the tubes are below or above the level of the fire-place.

But, however favourable this plan may be for heating hot-houses, the advantages for that class of structures are as nothing compared to those which it offers for heating dwelling-houses, and all kinds of manufactories. This will be understood at once, when it is stated, that the water may be circulated, under ordinary circumstances of attention to the fire, at from 300° to 600° ; and, with extraordinary strength of pipe, and application of fuel, to a still higher degree. It is found that 400° will roast meat. The workmen in the bank-note printing-office of Messrs. Perkins and Bacon have dressed a beefsteak at the farther extremity of the pipe of hot water used for heating the steel plates; and Mr. Perkins is constructing for himself an oven for roasting by water. It is easy to see, that, in a very short time, this will lead to extraordinary and most beneficial changes in domestic arrangements; and that, if we could get rid of our prejudices in favour of open fires, the smoky atmospheres of our great towns would be got rid of at the same time. Water at 500° , or, at least, water at 300° , for the purposes of cookery, and for heating reserve cisterns of cold water, or masses of metal or masonry, for various domestic purposes, including

warming rooms, heating baths, laundries, &c., may, at no distant time, be circulated by companies, in the same manner as gas; and, in London, instead of one fire for every room, as at present, there may be only one in a parish, or in every square of an acre in area. For the present, however, we shall not indulge in further speculations as to the uses to which this invention may be applied, but conclude by giving a description of Mr. Perkins's apparatus; and this we shall do, partly by copying, in his own words, a part of his specification, as given in the *Repertory for Patent Inventions for March, 1832*, and by engravings made from drawings furnished us by himself.

"A (fig. 44.) is a vertical section of the description of furnace I prefer, and B is a plan or horizontal section: in each of these figures the same letters

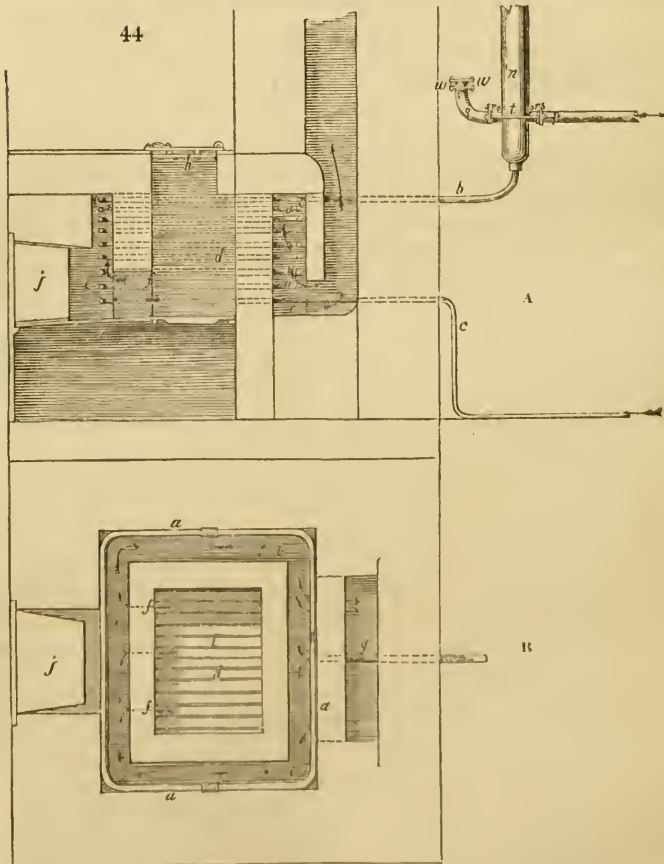

of reference indicate similar parts, and such is the case in the other figures in the drawings. The description of tubes which I have used, and find to answer, are what are called drawn gas tubing; and the size I most commonly employ is about 1 in. outside diameter, and the diameter of the inner area is about five eighths of an inch; but I do not confine myself to the use of this size tubing.

“ *a a a* (*fig. 44. A and B*) is a coil of tubing, which is placed within the furnace, as shown in the drawing; *b* is a tube by which the water passes from the coil *a*, when in a heated state; and *c* is the tube by which the water is returned to the coil, after having given off the heat, to effect the object to which the apparatus is applied, whether for heating the air in buildings, evaporating fluids, or heating metal, as will be more fully described hereafter.

“ The furnace consists of two compartments, *d* and *e*; the compartment *d* is that in which the fuel is burned, and the compartment *e* surrounds that at *d*, and is a sort of hot chamber in which the coil of tubes (*a*) is placed, and the water therein becomes heated by the heat which is generated in the compartment *d*, the smoke and heated air passing from the ignited fuel at *f* into the compartment *e*, and thence into the chimney (*g*).

“ The description of fuel which I prefer is coke or stone or other coal, as free from bituminous matter as possible, which is put into the compartment *d*, at the upper part at *h*, over which there is placed at all times a cover, to prevent any draft passing in that direction; by which means, when the fire is lighted, and the fuel is filled up to the top of the compartment *d*, and the opening at *h* covered, the air which produces the combustion will pass up through the fire bars at *i*, and the fuel on such bars will in a short time become an ignited mass: *j* is an opening or door in the front of the furnace, by which the same may be stoked, or the fire lighted.

“ *c, d, e* (*fig. 45.*) show the manner in which I construct the joints of the apparatus, which are shown on a larger scale, for the purpose of making them more clear. *c* (*fig. 45.*) shows in section the manner of connecting

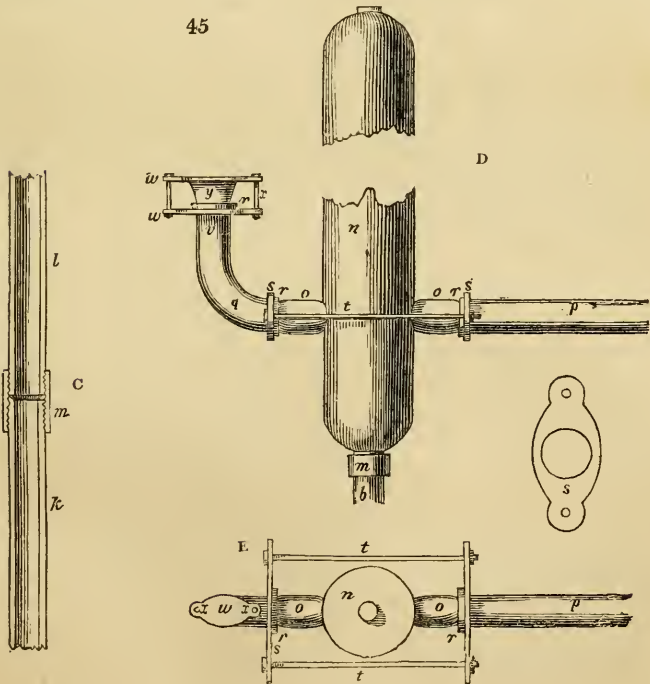

two tubes, *k* and *l*: it will be seen that the end of the tube *k* is tapered off both inside and out to a sharp edge, which butts against the straight surface of the end of the tube *l*. On the ends of these tubes are cut screws, the one having a right-hand screw, the other a left-hand screw, and by means of the coupling piece *m*, which has a female screw cut right and left, the two ends of the tubes *k* and *l* are brought together, and by this means a strong water-tight joint is made; and in this manner I connect any number of tubes together, according to the purpose to which the apparatus is to be applied.

“*D* and *E* (*fig. 45.*) are two views of the connections of other parts of the apparatus, and also of the part of the apparatus which is intended for the expansion of the water; *n* is an upright tube, closed at the top, having a small screw hole to let out the air when the apparatus is filled with water, but which is kept perfectly closed when the air is driven out. This tube *n* is usually made of a larger size than those in which the circulation takes place, and in this tube there should be an area equal to the quantity of expansion which will take place in the water contained in the outer tubes; and, as water expands to about one twentieth without being converted into steam, I leave at least double that quantity of capacity in the tube or vessel *n*. *o o* are short tubes formed into cones at their two ends: these cones enter into holes perforated in the tube *n*, and into the ends of the tubes *p* and *q*; the tube *p* being the one by which the hot water is conveyed from the coil *a*, after it has become heated, and the tube or pipe *q* is the point at which the apparatus is filled with water, and by which the height of the water is regulated; and this tube *q* is to be placed in such a position, that there shall be sufficient space above it, in the tube *n*, to allow for expansion.

“On the tubes *p* and *q* are two collars (*r*) formed, and by means of the two plates *s s*, and the screw bolts and nuts *t t*, there will be a strong water-tight joint formed to all the parts. At the top (*v*) of the pipe, there is a collar (*r*) formed, and by the plates *w*, and screws and nuts *x*, the cone *y* is strongly held in the opening of the tube *q*, by which the same is made water-tight when the apparatus has been filled with water. To the bottom of the expansion tube *n* is connected the pipe *b*, by coupling similar to that described in *c* (*fig. 45.*).

“Having now described the manner in which I conceive it best to construct the various parts of the apparatus, I shall now proceed to describe some applications of the same. *F* (*fig. 46.*) shows a longitudinal view, and *G* shows a plan of an arrangement for applying my improvements to hot plates which are intended to be used by copper-plate and other printers, for the purpose of heating the plates from which impressions are to be taken. I have not thought it necessary to show the presses, or any other parts of the machinery used for printing. The plates (*A A*) being intended to be used in place of the charcoal fire-grates heretofore employed for heating the plates at the time the ink is rubbed in, one of these heated plates (*A*) is placed in the proper position at each press, if more than one is to be heated; and it will be evident that a large number of presses may have their plates (*A*) heated by one set of tubes. The tube *p* is the one which, as above described, conveys the heated water from the furnace, and the tube *c* returns it back to the coil after it has given off its heat.

“The manner in which I construct the plates (*A*) is as follows. I make a rectangular mould to the size required, and place therein the bent part of the tube *p*, and then fill the mould with melted lead, or other metal, according to the degrees of heat such plates are intended to bear, by which means I produce metal surfaces, which become heated by the passage of the heated water through the tube *p*; and it is evident that such heated plates may be applied in a variety of ways, and for a variety of pur-

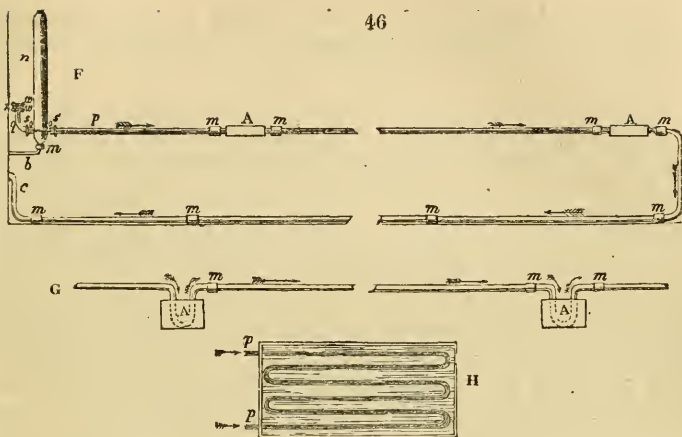

poses such, for instance, as hot plates for cooking. H (fig. 46.) shows the manner of applying the apparatus to a rectangular boiler, which boiler is shown in plan, and is applicable to the boiling of syrup in the making or refining of sugar; by which it will be seen that the heated water is made to circulate through a series of tubes, and give off its heat to the fluid contained in the boiler; or these tubes may be made to pass into steam or other boilers in a similar manner, and will cause the fluid contained in such boilers to become heated and evaporated.

“In heating the air of rooms of buildings, the tubes *p* and *c* may be made to pass around the flooring of such room, and where a large quantity of heat is desired, it will sometimes be desirable to have more than one pipe passing to and from the coil of pipes contained in the furnace, whereby a larger quantity of heated surface will be presented, which, being heated to a high degree of temperature, will give off the same to the air contained in the room or buildings, and warm the same; and I have found that when the circulating tubes present a surface equal to three times that of the coil of tubes in the furnace, I have not been able to burst the tubes.

“Having now described the nature of my invention, and the manner of carrying the same into effect, I would have it understood that I lay no claim to the various parts of which such apparatus is composed; neither do I claim the application of the circulation of hot water to the purposes above described: but what I claim as my improvements in such apparatus or method of heating the air in buildings, heating and evaporating fluids, and heating metal, consists in circulating water in tubes or pipes, which are closed in all parts, and have sufficient space allowed for the expansion of the water as above described.”

We hope the time may soon arrive, when one of those working men's colleges, which an enlightened, spirited, and most benevolent author, Junius Redivivus, has recommended in the *Mechanic's Magazine*, will be erected and peopled, and be supplied with heat, for all the purposes of domestic economy, comfort, and enjoyment, by Mr. Perkins's apparatus. Notwithstanding what has been said against the college of Junius Redivivus, and also against our own college (*Mech. Mag.*, vol. xvi. p. 332.), we are convinced that such arrangements, in the present state of society, would contribute uncommonly to the comfort of the working classes in London.—*Cond.*

ART. VII. *A new Trap for catching Moles, with some Remarks illustrative of its Superiority over the Traps now generally in Use.*
By A. F.

Sir,

ABOUT two years ago, I had the management of a small garden in Aberdeenshire; and, being very much annoyed with moles, I had recourse to different schemes in order to destroy them, always trying to find out some sort of trap that would require less time and trouble in setting than the common wooden ones: for, as is too often the case with gentlemen's gardeners in that part of the country, I had enough in the keeping and care of the garden and its produce to occupy all my time and attention, without mole-catching. It generally took me an hour every day, for several weeks, in the spring and autumn, to keep about a dozen traps at work; for the wooden springs soon take a set, and lose their power, when they are not attended to and tightened. I tried cast-iron traps, made in the form of forceps, and found that they answered very well when the tracks were through any sort of firm mould: but, when the tracks were through loose mould, the iron traps were every bit as troublesome as the wooden ones; for then they required to have a piece of stone or slate along each side, to prevent the mole from getting through without displacing the trigger; and they required also to be particularly covered, so as to be close enough to exclude the light, and prevent the free action of the air, yet so open as to allow the handles of the trap to extend freely as soon as the trigger should be displaced. All these inconveniences, however, I got rid of by using this very simple kind of trap, which I invented; and which possesses one particular advantage over any other kind that I have tried or seen, and that is, that it will catch two moles at one set.

It consists of a block of wood (*fig.* 47. *a*, upper view, with one end set; and *fig.* 48., under view) 10 in. long, 3 in. broad, and $3\frac{1}{2}$ in. deep; with a hole (*b*), $2\frac{1}{2}$ in. diameter, bored lengthwise through both ends. In the inside, half an inch from the extremity at each end, a groove is cut for a wire loop to fit into, as in the common wooden mole-trap; only that the grooves on the upper side of this one are cut quite through, having a small nail or pin of wire driven in through the middle, to keep the wires from rising above the wood. In the upper side of the hole, close by the grooves, three blunt-pointed pikes of wire (*c*) are fixed, so as to stand a quarter of an inch out of the wood. The holes for the triggers are bored in the centre of the upper side, 3 in. from each end; and in the

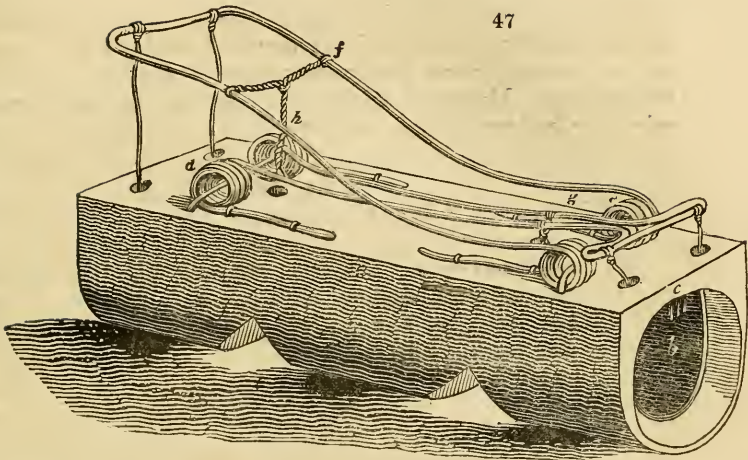

lower side, opposite each trigger-hole, is a small piece cut out, as in the common trap. The springs are made of iron

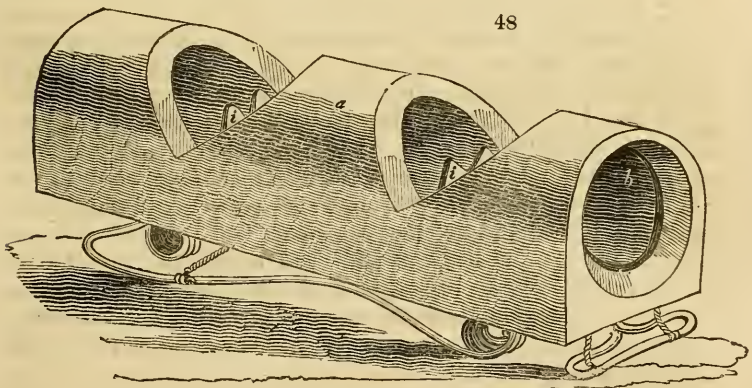

wire, of about one eighth of an inch in diameter (*d* and *e*); and are exactly of the same form as those of the common mouse-trap, having a cross wire fixed $1\frac{1}{2}$ in. from the top of each spring (*f* and *g*); from which the catches, which are likewise made of wire (*h*), are suspended. These catches are retained by the plug or trigger (*i*) till it is displaced by the mole. *Fig. 49.* is the trigger, of the full size.



I saw, in your Magazine (p. 36.), the description of a new

kind of mole-trap ; which, I am of opinion, would require so large an opening, to allow it a chance of catching both ways, as to occasion great inconvenience, and render it of but trifling use. My traps might be made by gardeners themselves, in bad weather, when little else could be done. The materials of each trap did not cost above 3*d.* in Aberdeenshire.

I am, Sir, yours, &c.

Kensington, April 24. 1832.

A. F.

WE have had one of these very superior traps made under the direction of A. F., and we have sent it to Messrs. Cottam and Hallen, Winsley Street, Oxford Street, who will supply them to the public at 1*s.* each. — *Cond.*

ART. VIII. *On planting and laying out Grounds.* By M. HERMAN KNOOP KLINTON, Landscape-Gardener, Ghent.

(Continued from Vol. VII. p. 561.)

“ WE must remove those ash trees,” said my employer ; “ because they are out of all proportion to the oak and elm.” This, you will recollect, was the *ipse dixit* of my worthy patron, the burgomaster of Haarlem ; and I promised to tell you how I prevailed on him to let them remain, in spite of his notions of proportion. “ What you say would be very true,” said I, “ if trees were architectural columns ; but, as they are only trees, we must have recourse to the landscape-painters of Italy, rather than to Vitruvius.” “ Why the landscape-painters of Italy ?” said the burgomaster. “ Why Vitruvius ?” said I. We agreed, that if Vitruvius was entitled to be considered an authority in architecture, the landscape-painters of Italy were entitled to be considered as authorities in landscape-painting.

My next step was to convince my patron, that the beauties of landscape-painting might be referred to as a test of the higher beauties of landscape-gardening. This was not so easily done. “ What is there in the rough foregrounds, rugged trees, broken branches, and objects in a state of decay, in pictures, which can apply to a garden and grounds ?” said my employer. This, I confess was rather a home-thrust (*grand coup*) ; but I began, as usual, by agreeing that to a certain extent he was right. “ But,” says I, “ the rough foreground, rugged trees, &c., are only inferior details, or subordinate means of the artist, for the production of certain

effects. Thus, the rough foreground is generally made use of to aid in producing the effect of distance in the more light and delicately painted parts of the picture. As to the rugged trees, they are not in all pictures; if you find them in almost every piece of Salvator Rosa, you will seldom or never see them in Claude or Poussin. But, even if they were to be found in the paintings of these artists, it does not follow that you are to imitate them in garden scenery. Do not forget that the beauties of landscape-painting are to be referred to as tests, and not as subjects of servile imitation. The proportion or connection of one part with another is to be tried by the proportions or connections which are imitated from nature by landscape-painters. In short," continued I, "it is principles that we are to adopt from the great landscape-painters, and not mere forms, which have often nothing to do with gardening."

After expatiating on Girardin's fundamental principle, of the unity of the whole, and the connection of the parts, till, I believe, my patron was bewildered, he at last asked me whether these principles were generally acknowledged by those who had employed me in France and Germany. Now is my time for a victory, thought I; and I told him, "Certainly, in both countries, by all the men of rank and of reputation for taste." This reconciled him immediately to my dictum; and I had not only the group preserved, but every thing else my own way. The scene of my operations, however, has been since sold, and my patron laid on the shelf (*mit hors de combat*).

Thus, Sir, you see that there are at least two ways in which a professional man may carry ideas into effect: by establishing from precedent his authority as a man of taste, after which he becomes an autocrat in his profession; or by reasoning upon each particular part of his plan, and carrying conviction on each separately to his employer. The last may be fitting for a young man; but, I can assure you, it is neither an easy nor an agreeable task, at least in this country, which is far behind yours in matters of taste.* I shall con-

* Not so very far. We could point out places in the neighbourhood of London, displaying the same sort of crudities as those mentioned in this paper, and even greater ones. As to the absurdity of placing a statue on a square and round column, it is not greater than may be seen in one of our suburban squares, where two half columns, bought at the sale of the front of the old Opera House, support a Russian eagle. For other absurdities of a like kind, we refer our readers to the notice, in the *Tour of a German Prince*, of a certain Stanmore Villa, as laid out and decorated by a retired printseller, now a Middlesex magistrate. — *Cond.*

clude this letter by detailing an example, which I shall bring forward as a proof of this last assertion.

There are many wealthy merchants in Amsterdam, and all of them have gardens and country houses at a short distance from the town. At the very time [in 1826] when our mutual friend Dr. H—— showed me, for the first time, your Gardener's Magazine, I was called on to lay out an approach road, or rather to correct one already laid out, to a residence in a small park about ten miles from Amsterdam. The owner of this residence had some pretensions to taste, but more to a heavy purse; and he had in his employ a German officer, who knew something of architecture, and thought that he also knew something of gardening. To do this architect justice, however, he was obliged to conform to the will of his patron in every thing; for he was too near him to command sufficient respect to be considered as an authority, and reasoning was out of the question. Unless a man of taste has to deal with reasonable people, he has no chance of becoming an autocrat at home.

Well! I arrived, and was first shown round the grounds by my German friend. I found almost every thing wrong; but I said little; making it my business, as I always do on like occasions, first to hear the reasons for what is before me. In one part of the shrubbery a square column, joined to a round one, supported a figure of Flora. "Why not both square, or both round?" asked I. "These," returned my German friend, "formed part of the portico to M. van B——'s house, which was taken down two years ago, and sold in lots." Directly in front of the house, there was a rustic fountain on a naked piece of turf; the fountain profusely covered with shells, and spouting water from a gilt dolphin. I soon recognised this as an imitation of a fountain in the park at Enghien; but in that park it is in a low shady situation, covered by trees, and moreover the dolphin is not gilt. "Why no bushes or trees about this object?" asked I. "If any were placed between it and the house, they would hide the dolphin from the windows," says the architect; "and, if any were placed on the other side of it, they would conceal the distant scenery." "Pass on," said I; "and let us see what comes next." A short crooked walk led from the house to an orangery, which we entered; and I could not help being struck with the size and beauty of the orange trees, and other exotics: they occupied my attention so much, that I neglected the indications of my guide, who directed my eyes to a picture, painted on the wall, at the further end of the structure. It was a view of mountain scenery, rocks, and

cottages, imitated from a diorama some time exhibited in Paris [and also in London], and it was painted by an Amsterdam artist of merit. I was asked, whether this had not a good effect with the orange trees, and handsome Cape and Chinese plants in the foreground; for, you must know, Sir, we are very much in the habit of painting landscapes as terminations to walks and vistas, both in the open air and in green-houses. "The taste is vulgar," said I; "and fit only for the garden of a *ginguette*." Just as these words escaped my lips, the proprietor came up. "And why may not a painted picture form a termination to a natural view, when there is nothing better?" asked he. "I see no reason why it may not," said I, "except that I consider it in very bad taste." "Why so?" "Because the two objects are incongruous, and the first principle in any composition is unity of expression." "And yet we see landscapes of this sort in Baron H——'s gardens." "I cannot help that," said I: "the force of my reason remains. Do you find them in England or France?" continued I. "Yes, in M. Boursault's garden." This is true, as you probably know; for M. Boursault's garden is bounded on one side by the gable ends of high houses, and he has obtained permission to paint trees on these, to render them less unsightly. I should have painted weather stains only, had I been M. Boursault; but, fortunately for my opponent and his arguments, M. Boursault preferred trees. I thought it prudent to yield quietly, but, at the same time, without compromising my opinion; and I found I gained by this, for my patron soon after acknowledged that he had never seen painted landscapes in any English garden but that of Vauxhall. "What would you recommend for a termination?" he enquired. "Cover it with orange trees, trained on a trellis," said I; "or, if you will lengthen your perspective, let the end be entirely of looking-glasses, formed into doors and windows." "A capital idea!" said he; "it shall be done; but, in the mean time, let us dine, and I will show you the remainder of my improvements afterwards."

H. K. K.

Ghent, Sept. 1831.

ART. IX. *On pruning Forest Trees.* (From "Essays on Vegetable Physiology," preparing for the Press.) By J. MAIN, A.L.S.

THE pruner should be a good vegetable physiologist; for unless he has an intimate knowledge of the components of the

plant, and their tendencies and functions in the system, his operations will always be performed in the twilight of uncertainty.

If we except the failure of the lowest branches of trees, there are few indications in nature showing the necessity of pruning. In natural forests, trees generally grow closely together; of course, their lower branches, being deprived of air and light, quickly perish; but when, by accident, they stand singly, the lower branches are as permanent as those of the top, nay, even more so; and, moreover, they appear to be as necessary a part of the system. When, however, trees are taken under the care of man, they are subjected to control, and are trained to answer the purposes for which they are cultivated, whether that be for the timber they supply, the shelter and ornament they afford, or for the fruit or flowers which they yield. For these different objects trees undergo various manipulations of the pruner, which may be considered under different heads.

Forest Tree Pruning. — Forest trees are regarded either as objects of ornament or of profit. Ornamental trees require no assistance from the pruner. Natural forms cannot be improved by art, even when directed by the most refined taste. It is only in woodlands, raised or maintained as sources of profit, that the skill and exertions of the forest pruner are available. In such cases the special object is to obtain the greatest quantity of marketable timber. With this view the pruner endeavours to form stately, straight, and clean-grained boles, standing as closely together as is consistent with allowing every tree a sufficient share of light and air. The interdistances, and the desired form and length of bole, can only be obtained by giving attention to the trees in the early stages of their growth. To have timber of the finest grain or quality, no lateral branches that grow within the convenient reach of the pruner should be allowed to arrive at any considerable size; such branches act as rivals of the principal stem, and, if they remain to act injuriously before they are cut off, the wound thereby made is so large, that a defect in the timber is the certain consequence. The soundness of timber is not deteriorated by pruning, provided the wounds made in the execution be no greater than will be healed during the following summer. A scar made by the axe, bill, or chisel, if exposed longer than twelve months, will always remain a flaw; for, though it may be afterwards covered smoothly over by the new collapsing wood, it is impossible that any perfect union can take place between a surface of

timber which has been exposed to the air for several months, and that which is subsequently formed over it.

Forest pruning is generally performed in winter; all wood work (except oak felling and peeling) is done in that season, chiefly because the leaves are off, and the growth has stopped. It is necessary to observe, however, that pruning performed in the beginning of summer would be a better practice for the good of the trees. The reason is, because wounds made in winter do not begin to heal till after the summer growth takes place. That principle of the tree which is alone capable of closing a wound is dormant in winter, and the wound made in that season is too long unprotected; whereas, if branches are cut off when the vital principle is every hour extending itself, the incision is sooner closed, and, if not very large, it is completely covered before the growth ceases in the autumn. It should be a rule with the pruner never to make a wound that cannot be healed in the course of six months: but he can only attend to this by a timely application of the knife or chisel. A handsaw * should never be used in pruning forest trees; because, if the irregular branch be so large as to require this tool, it had better remain where it is; and because, though it may injure the columnar form of the bole externally, and the regularity of the grain internally, the place where it joins the main body will always be found sound, which it would not be if cut off. Very tall handsome boles may be formed by the assistance of long ladders, handsaws, and jack-planes; but, though these large and carefully polished scars will be in a few years covered with healthy wood and bark, the marks of the tools will always remain a defect in the timber when it comes to the saw-pit.

These circumstances show decidedly the necessity of early pruning, as well to secure quality, as desirable forms of timber; for though all trees have a specific character of growth, with a more or less branched head, which they naturally assume when at liberty so to do, yet they submit to the hand of skill; and many trees of bush-headed character may be trained into a light aspiring shape, and well proportioned length of bole.

To take care that every tree has a principal leader is a material object of early culture, and to maintain its superiority in after growth, a chief point to be attended to. All laterals that show a rivalry, so as to divide or deform the axis, should be displaced. Very small branches, or spray, need not be

* A stout turning or keyhole saw may be used for small branches, as being more convenient than either knife or chisel.

taken from the stem : whether they live or die, they cannot deteriorate the timber.

Forest tree pruning should be done gradually, and continued till the business becomes inconvenient, or too expensive ; and, if judiciously done during the first ten or fifteen years, sufficiently fine forms will have been given, and proper length of bole secured. A great deal has been written relative to the propriety of reducing the head of a tree, as a means of increasing the bulk of the trunk. The question lies in a nutshell : the larger the head, the larger must the trunk be also. The diameter of the latter is increased by the number of branches which are, or *have been*, produced by the former. In proportion as the roots are increased and extended, in like proportion are the stem and head. Severe mutilation of the head paralyses the energies of the roots, and *vice versá*. Reducing the number of branches, to give magnitude to the stem, is ridiculous. Regulating the growth of the branches, by stopping or cutting out such as are over-luxuriant, gives supremacy and direction to the leader, but no addition to the stem or any other part. Every individual twig of the head is a part of the stem, and the former could not be developed without the assistance of the latter ; which, while it conveys support, is itself enlarged by this very function. In fact, every member of a tree depends on, and, in its turn, lends assistance to, every other, when all are in perfect health. The only exception to this is an accidental luxuriance, sometimes exhibited by a single branch, and a certain division of the root, which progress together for several years before the rest of the tree. For such irregularity, however, no good reason can be assigned.

The foregoing remarks are applicable to deciduous trees only : on them if the forester bestow timely attention for a few years, by properly directing the juvenile vigour, he will seldom fail in raising valuable timber.

As the different kinds of forest trees are used for various purposes, the forester endeavours to supply the various demand. It is wrong that any advantage derivable from woodlands should depend on, or be left to, chance. Oak of the straightest and cleanest grain is required for planking, beams, posts, &c. ; but, besides this description of oak, in the dock-yards, cross-grained butts and knee-timbers are in request, and consequently valuable. The former quality of oak, beech, and other kinds of forest timber, is obtained in the shortest time by rather close planting, early and careful pruning, and timely thinning, if necessary ; the latter, by open planting, and partial pruning, i. e. not by aiming at a tall smooth bole,

but by leaving the branches in sets of three or four (as it may happen), diverging from one place, and clearing the trunk of all intermediate branches and spray between these sets. This style of pruning, though it has perhaps been never or but rarely executed, is, nevertheless, quite practicable: it is only pruning the oak, so as to make the disposition of its branches resemble those of a fir tree, but with greater distances between the tiers. But in all ordinary cases, if a sufficient length of bole be gained, the branched head may be depended on to furnish knee timbers. Pine and fir timber, for the use of builders and mast-makers, cannot be too free from knots, and it is impossible to have it so, unless planted and trained up as closely as possible. When so standing, no lower branches can live to distort the longitudinal structure of the axis. The centre of such stems, when cut up for use, only shows the diminutive bases of the first laterals; but every concentric layer of wood imposed after these first branches decay is uniform in longitudinal arrangement, and is uninterrupted by knots. A single fir tree requires a large space, and produces the worst timber; its first branches continue to enlarge and extend themselves, sweeping the ground as long as the trunk continues to rise; and though the latter arrives at a great size, its quality is of the most inferior description. In fact, fine-grained deal cannot be produced, unless the trees are planted, or chance to stand, as those in Norway from which battens and ladder poles are cut for exportation, so closely together as to prevent all extension of branches. All the pine and fir tribe intended for profit should be planted to grow up, and be all cut down, together, like a crop of corn. They do not admit of being partially drawn. They may be called, on this account, social trees, thriving best in congregations; for, so soon as the unity of the assemblage is broken, the exposed trees, losing their wonted protection, not only cease to thrive, but often die. Firs planted for ornament should stand at considerable distances, otherwise they never show the grandeur of their forms. The pruner must not touch them; his interference only tends to make them the most ugly objects in the vegetable kingdom. Planted as nurses in young plantations of deciduous trees, they are easily kept within due bounds, by a very simple method of pruning, practised by Mr. Billington; viz., by pinching off, from time to time, the leading buds of the branches. This induces a spray-covered rather than a naked stem, and prevents the encroachment of the branches on the neighbouring trees, without destroying their own character and usefulness as nurses. By the same means, fir trees may be formed into impervious

screens, or sheltering hedgelike boundaries, highly useful in many cases of rural improvement.

Ash timber is produced of superior quality, by being planted and trained up in close order: its toughness, and its cleanness of grain make it a desirable material for the coach-maker. Straight smooth sticks of ash 50 ft. in length, and from 8 in. to 12 in. square, are highly prized by all machine-makers. Whether for timber or underwood, this tree should always be grown in plantations by itself, not only because of its greater rapidity of growth, but because it is a most noxious tree in hedgerows, or when standing singly in cornfields or meadows.

Oaks and elms are best suited for hedgerows. It is incredible how much elm timber can be raised in hedgerow order; and as the superiors are cut down, a constant succession of young stems keeps rising from the old roots. No tree bears pruning so well as the elm. So severely is this performed in Middlesex and elsewhere, that, in many cases, a very small branch only is left at the top every time the tree is shredded. This property, of being unhurt by wholesale pruning, is owing to the remarkable vitality of the tree, which, being in every part studded with latent buds, throws out a numerous spray over all the stem. This, though unequal to increase the diameter of the trunk as a large branched head would do in the same time, yet gives the timber a gnarled character, particularly useful for the naves and fellies of carriage wheels, and other purposes where liability to split would be a defect.

In countries where fuel is scarce or dear, hedgerow trees are pollarded, and periodically lopped for domestic purposes, and for fencing stuff. Oak, elm, and ash are chosen for this barbarous purpose. The boles are preserved, as being the property of the landlord, while the loppings are considered that of the tenant. The trunks soon become hollow, and, consequently, useless as timber. Willow pollards are extensively planted in low meadows, for the purpose of growing poles, stakes, and headers for fencing. Willow holts, for supplying basket-makers' rods, are generally cut every year. Under this management, it is observable that every new crop of shoots is perfected by a new growth of fibrous roots. The centre of a willow pollard and that of a stool soon decay; and, in the rotten mass roots from the superior buds are seen to strike and luxuriate. The spectacle of a hollow willow tree being partly filled with roots, which from time to time had descended from the shoots of the head, gave the late Dr. Darwin, it is probable, the first idea of the wood of

the stem being formed by descending radicles from the buds. But this example of the willow is no corroboration of the doctor's idea, when duly considered. The shoots of the willow, like those of all other trees, it is perfectly true, are prolonged by the assistance of radicles simultaneously produced. The doctor's idea was, that these two members are immediately connected, and that the latter are actually thrown out by the former, as in the case of a single eye of a grape-vine struck as a cutting. But that acute philosopher forgot that in the case of a pollard willow, or, indeed, any other tree, there exists an intermediate vital member which connects the extremities, and which is constitutionally calculated to allow intercommunication between them, without any portion of the shoot descending to the root, or any part of the latter, except fluids, ascending to the former. The intermediate channel is the seat of vitality, formed of cellular matter and a vascular apparatus, which, while it conducts, is itself increased by the impulse and qualities of the rising current.

An argument in support of heading down young, and judiciously pruning old, deciduous trees, may be drawn from the natural history of many sorts of willows. They are not constituted to be permanent. So far from their bulk, number of branches, and quantity of foliage being incentives to increased vegetative power, an exactly contrary effect is the consequence. As they increase in size, the more feeble is their growth, till at last all vitality ceases; whereas, were they repeatedly cut in, new power would be imparted, by calling forth latent principles of life, and their existence would be prolonged to an indefinite length of time. The common furze (*Ulex europæa*) requires to be frequently cut, or eaten down, to keep it alive. The alder tree is comparatively short-lived; but may be reproduced successively, for ages, from the same stool.

The preceding remarks show that it is quite practicable to obtain a fair length of sound bole, say, on an average, of 20 ft. or 25 ft., without much sacrifice of time or money, and without fear of checking the growth by pruning. All branches which appear contending with the leader, and threaten to divide or divert it from its perpendicular course, should be taken off close to the bole, and before they are more than about *one inch in diameter*. This being attended to, no wounds will be made but what will be nearly healed over before the growth ceases in the autumn.

The annexed figures represent the grain or structure of the wood, as it appears on a perpendicular section supposed to be

cut through the pith and opposite branches of a pine or fir tree, to show the effects of pruning.

50

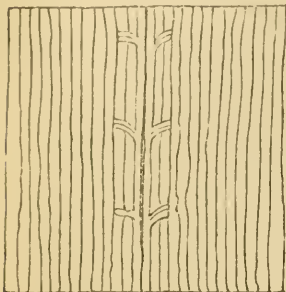

51



Fig. 50. Section of a tree of which the branches had died, or been cut off in the third year progressively.

Fig. 51. Section of a stem of sixteen years' growth, showing the remains of branches pruned in the tenth and twelfth years.

52

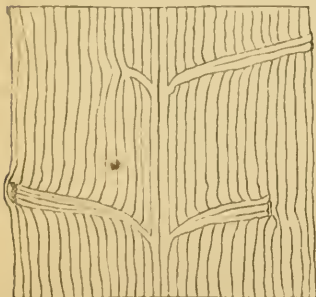

53

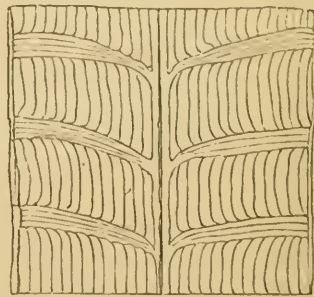

Fig. 52. Section, showing the effects of irregular pruning at different times.

Fig. 53. Section of a stem which has never been pruned.

It may be observed of pine timber in general, that it is less liable to be deteriorated by dead stumps of branches than the timber of deciduous trees; the resinous quality of the sap prevents decay, and, being concentrated in the closer texture of the knots, renders them even harder than the other parts of the wood. But the sap of oak, ash, elm, and most other forest trees, has no such preservative qualities; a rotten stump of a branch will often cause the destruction of the finest trunk. It may be added, in conclusion, that cutting close to the bole, provided it be done in time, is the only way to obtain clean-grained timber, as the above figures show. Stopping or cutting off the branches at some distance from

the stem, deforms the tree; and though it may not affect the soundness of the timber, it certainly deteriorates its quality for many purposes of the builder.

Chelsea, Feb. 20.

THE foregoing article we consider by far the most valuable that has appeared in this Magazine, on the subject upon which it treats, and it may be considered as an earnest of the value of the work (great part of which we have seen in manuscript) from which it is taken. Mr. Main, as a practical man, and whether exercising his talents and taste as a landscape-gardener, or his science and skill as a forest-pruner, has the great advantage of possessing a thorough knowledge of vegetable physiology, and, at the same time, of having had very extensive practice in every department of gardening and rural affairs. We request those interested in the subject of his present paper, whether gardeners and foresters, or their employers, to fix firmly in their minds Mr. Main's concluding direction, that branches should be cut off close to the bole before they are above 1 in. in diameter; and also to observe his remark, that, if this is done in spring, or just before midsummer, the wound will be entirely or nearly healed over in the same season (p. 309.). Let it also never be forgotten, that all wounds which are not healed over in the first season leave defects in the timber (p. 304.). Had forest-pruners forty years ago been aware of these facts, and acted on them, the trees pruned about that time, and now felling, would have sold at a very different price from what they are now selling for.

Great advantages have resulted in Fifeshire, from the employment of Mr. Sang (the editor, or rather author, of the last edition of Nicol's *Planter's Calendar*, and a correct physiologist) as an inspector of plantations. We could wish to see our much-esteemed friend, Mr. Main, add to his profession of landscape-gardener, that of inspector of plantations in England; for certain we are, that there is no man in the kingdom better qualified for the office. Did we possess extensive plantations, we should send for Mr. Main (whose charge, we believe, as a landscape-gardener, is two guineas a day and expenses), and employ him for two or three days to instruct our forester in the proper methods of thinning and pruning. We would afterwards arrange with him (say for 10*l.*, 20*l.*, or 30*l.* per annum, according to circumstances), to pay us a professional visit, at least, once every year in the pruning season. We know there are some foresters who would object to this sort of interference, and we know also that there are some who understand their business so well as to render it unnecessary; but the owners of plantations may rest assured of this, that those foresters who understand their business best, will rather feel pleased than otherwise, at the idea their works being subjected to the examination of a scientific man who can duly appreciate their merits.

In conclusion, we repeat what ought to be the forest-pruner's golden rules: — No branches to be cut off which do not interfere with the leader; no wound, thus or otherwise made, to be larger than an inch in diameter; and no pruning in autumn. — *Cond.*

ART. X. *On the Culture of Mushrooms in Melon Beds.* By Mr. JOHN COLLIER, Gardener to Edmund Woods, Esq., Shopwick, near Chichester.

Sir,

HAVING seen, in Vol. VII. p. 731., a letter from Brighton, signed J. S., in which allusion is made to a mushroom of unusual size raised by me, I beg leave to state that the mushroom in question measured in circumference 3 ft. 7½ in., while its weight was 2 lbs. 1 oz. ; nor was this the only large mushroom on my bed, as many measured the same in circumference as the above, though none of them were of exactly the same weight. As J. S. expresses a wish to learn some particulars regarding the process pursued by me in raising this mushroom, I am induced to trouble you with the following brief account of my method : —

The bed in which my large mushrooms were raised was an old melon bed, in a brick-built pit. About the middle of July, a bed of long and short stable dung (fresh from the stable), which had only gone through a slight course of fermentation, was made in the above pit, for the twofold purpose of raising melons and mushrooms ; the bed was spawned in the usual way, but not till about a fortnight after the melons were ridged out ; as, if done earlier, the bed would be too hot to receive the spawn. As soon as the bed was spawned, a quantity of stiff yellow loam, mixed with a little half-decayed leaf mould, was laid on it to the depth of 12 in., for the melons to grow in, and gently trodden down : this I have always found to be the best compost for mushrooms. The melons ripened about the end of September ; and when all were gathered, which was about the end of October, the whole of the bed was cleared of the old plants, and about 3 in. of the mould removed from the surface, thus leaving mould to the depth of 9 in. for the mushrooms. The bed was then well watered, and again at the latter end of November : but no more water was given all the winter, save a little which might drain from a quantity of potted geraniums, which were placed on the bed for protection during the winter months. About the middle of the ensuing February the mushrooms made their appearance in the part of the bed next the wall. The geraniums were immediately removed, to allow the mushrooms space to grow all over the entire bed, when several pots were found lying on their sides, being pushed aside by the mushrooms boldly protruding through the earth underneath them. Though some of the mushrooms had only just made their appearance, still many measured 9 in. in circumference. In

the middle of March the entire bed was completely covered, and in many parts they had thrown themselves up in large hillocks, some growing out of others. Thirty-five button mushrooms were gathered from some of these hillocks at one gathering; the bed still continuing to bear equally well up to the month of May; and it would, I think, have borne up to June, but it was necessarily destroyed to make room for another melon bed. By this mode of culture, the thickness of the mould, and hot atmosphere of the bed, necessary for the growth of melons, will prevent the mushrooms from appearing before February. After the month of March the bed should be shaded from the mid-day sun, and plenty of air given, and water occasionally. Too much care cannot be bestowed on a mushroom bed, when first made; for if it is 2 or 3 ft. high at first (which is the height I recommend for a mushroom bed), it heats too violently, thus destroying the fungous quality of the dung. To avoid this danger, when I make a bed for mushrooms alone, whether under sheds or glass, I make the bed 18 in. high at first, letting it remain so for five or six days, and examining it every day, to see that the heat does not exceed 100° ; and when I find the heat decline, I again add 18 in. more on the bed, making, on the whole, 3 ft. high, of long and short stable dung, quite fresh. The bed should still be examined every day; and, when the heat is on the decline, spawned in the usual way. The bed must be then covered with the before-mentioned loam to the depth of 3 in., and never less. To insure a good crop of mushrooms, both in quality and quantity, I am quite convinced that it is a very bad practice to reject long litter in the formation of the bed; for this reason, beds made with horse droppings only soon decay, and consequently the spawn must perish, after producing but a middling crop of mushrooms. Such beds as these, which are usually made only about from 9 to 12 in. high, and generally on shelves, will, I believe, never produce a plentiful crop in the winter months, unless there are fires kept to heat the atmosphere of the sheds where they are grown; but, if I am not correct in this opinion, I hope some of your able correspondents will set me right. In my beds there is a steady and a lasting heat, and they do not decay so soon by at least six weeks as those made by horse droppings only. I have each bed bearing generally from ten to thirteen weeks; and when I have taken them down, I have always found them a solid mass of spawn from top to bottom.

I never cover my beds close on the mould. When made in a shed, I have the litter which I cover with supported from

the bed by props and boards laid across, and at the distance of about 3 in. from the surface. This will prevent the woodlice from attacking them; and the mushrooms will not be drawn up weak, but will be firm and of a good flavour. In beds under glass, the glass is covered in cold weather, and not the bed inside, by which means the produce will be much greater, and of better flavour.

In conclusion, I beg to inform your correspondent, J. S. (Vol. VII. p. 731.), that my success in the growth of mushrooms entirely depends on the quality and quantity of the dung used: together with the depth of loam, which should never be less than 3 in. It matters not whether the beds are made under glass, or in pits without glass, provided they are covered with something to keep out the wet and frost; they will bear plenty of mushrooms either way. The only motive I had for growing mushrooms under glass was that of economy, by first having a crop of melons, and afterwards a crop of mushrooms, on the same bed. Should any doubts arise in the minds of any of your correspondents as to the size and weight of the above mushrooms, I can refer them to gentlemen in this neighbourhood who have seen them measured and weighed, and who have also seen the bed. [See Vol. VII. p. 731.]

I am, Sir, yours, &c.

JOHN COLLIER.

Shopwick, Chichester, Jan. 30, 1832.

ART. XI. *Abridged Communication.*

To avoid the Danger of rank Steam from Dung Linings injuring Plants in Frames. — Having seen, in your Magazine (p. 39. and 40.), a plan suggested by a correspondent, to prevent the rank steam of the outside dung from entering the vacuity left to admit air by night into the frames of early forced cucumbers, I beg leave to offer to your notice a very simple remedy, which I find has the desired effect, and which may be applied to any common lights. Instead of filling the lights with glass in the usual way, I have two blank squares of wood in the top of the lights, in the centre of which is a hole cut 1 in. in diameter, and covered with a piece of tin or lead, so fastened as to turn with ease: these I open, as air may be required, either by day or night. — *William Prestoe, Gardener to G. Butler, Esq. Hill Place, Draxford, Hants, March 29. 1832.*

REVIEWS.

ART. I. *Transactions of the Horticultural Society of London.*
Second Series. Vol. I. Part I. 4to. London, Hatchard.

(Continued from p. 178.)

2. *An Account of an economical Method of obtaining very early Crops of new Potatoes.* By Thomas Andrew Knight, Esq. F.R.S. &c., President. Read May 4. 1830.

THIS paper, Mr. Knight believes, will be found to point out the means of obtaining new potatoes at much less expense than by any method now practised, and in a state of great perfection.

Potatoes, which have been buried sufficiently deep in the soil to render them secure from injury by frost, usually vegetate very strongly in the succeeding spring; and Mr. Knight was thence led to hope, that, by planting in September large tubers, which had ripened early in the preceding summer, and had by a period of rest become excitable, he should be able to cause roots and stems to be emitted, to some extent, in the autumn; and that these, by being well defended from frost through winter, might operate so as to afford a very early produce. The experiment was not successful. The tubers vegetated almost immediately, and the stems just reached the surface of the ground, when they were destroyed by frost; and, although the ground was immediately so well covered as securely to exclude frost from it, not a single plant appeared in the following spring. Mr. Knight, therefore, concluded that the experiment had totally failed, and that the tubers planted, after once vegetating, had perished.

In the following summer, Mr. Knight found that the tubers had not perished, but had formed young ones under the soil. The experiment was, therefore, repeated in the autumn of 1828, and an excellent crop of young tubers was found to be produced by them in the June following, without a single plant appearing above the soil. The tubers planted were of the largest size that Mr. Knight could obtain of the ash-leaved kidney.

Our readers will observe, that what Mr. Knight states to have taken place, is precisely similar to what happens when

potatoes are laid between layers of earth, in boxes, and placed in any dry covered place free from frost. It is evident that, as there are no leaves formed, no new vegetable matter can be generated; but merely the transformation of the vegetable matter in the old potato into the form of new tubers. All that is obtained is a small quantity of a delicate article, for a large quantity of a useful one. Half a dozen modes of doing this will be found given in the *Encyclopædia of Gardening*, 2d edit. p. 594.; and a mode practised in Scotland, very similar to that of Mr. Knight, will be found described in our present Volume, p. 56.

The remaining part of Mr. Knight's paper describes his economical method of obtaining early potatoes; but we really cannot see in what the economy consists, or in what respect his mode of procuring potato sprouts is better than that described by our correspondents R. W. (Vol. I. p. 405.), Mr. Saul (Vol. II. p. 47.), and a Denbighshire gardener (Vol. II. p. 171.). Our opinion is, that it is nothing like so good; but, that our readers may judge for themselves, we shall give the remainder of Mr. Knight's paper verbatim. We are the more anxious to do this, because Mr. Knight has charged us with misrepresenting a former communication on the same subject (Vol. V. p. 718.), and even threatened us in no very measured terms (Vol. V. p. 719, 720.). It is not, however, on account of Mr. Knight's threats (to "bear us down," &c.), that we give his communication at length; but because we really do not fully understand his paper, are most solicitous to avoid misrepresentation.

"Similar experiments were made in the last autumn; but the temperature of the ground was so low, owing to the excessive coldness of the preceding summer, that not a single tuber vegetated. A part were therefore taken up, and made to vegetate by artificial heat, till they had emitted stems about 3 in. long; when they were taken from the soil, and the further progress of vegetation arrested. In the middle of January, these were put into a pot with some barren sandy soil, and placed in the pine-stove, and supplied moderately with water, till the middle of March. At that period I discovered that small new potatoes had been abundantly generated, and water was not subsequently given till the middle of April; when I found the pot to contain very well grown young potatoes, which were without any other defect than that of not being, to my taste, sufficiently mature. The requisite degree of artificial heat to insure success in experiments similar to the preceding, may, of course, be obtained from a variety of different sources, which I need not point out; and not improbably, I think, by means of a temperate hot-bed, the surface of the mould of which might be applied to other purposes; but I should prefer clean and barren sand for the tubers to be placed in, as those could not receive early benefit from a rich soil, and their produce might be injured in quality.

"The largest crops of early potatoes will usually be obtained from tubers which have ripened late, and somewhat imperfectly, in the preceding year; but it is quite essential to the success of the preceding experiment, that

the tubers, which are planted in autumn, should have ripened early in the foregoing summer; for otherwise they will not be found sufficiently excitable in autumn. It is also necessary that they should be of large size, otherwise the young potatoes which they afford will be small; and it will be advantageous, if the tubers to be planted have been detached from their parent plants, upon their having just attained their full growth.

“ I believe, but I am not prepared to speak upon the evidence of experiment, that the best and the most economical mode of treating the old tubers, after their progress of vegetation has been arrested by cold, will be to put them into such heaps as are usually seen in the gardens of cottagers, and to cover them with mould; as a very large quantity would occupy only a small space, and their produce would there probably acquire a more early maturity, and might be collected at any time with little trouble.

“ A writer in Mr. Loudon’s *Gardener’s Magazine* [Vol. II. p. 171.] has recommended the exposure of such potatoes as are intended for planting to the sun, as soon as they acquire their full growth, till they attain a green colour; and I am inclined to think the process may prove in some degree advantageous, for the action of the sun and air certainly causes chemical changes to take place in their component parts; and chemical changes are the precursors and concomitants of excitability, if not the cause and source of it. I am also inclined to think that similar treatment would be beneficial in the culture of all those varieties of potato which do not naturally vegetate till late in the spring.

“ I am not prepared to say what weight of new potatoes may be obtained from any given weight of old; but I have reason to think that the young will be equal to the weight of one third at least of the old; and (as I have shown in a communication two years ago) [given *verbatim*, *Gard. Mag.*, Vol. V. p. 721.] that more than 35,000 lbs. of our best and earliest variety of potato, now cultivated, may be obtained from an acre of ground, the mode of culture recommended will not be found expensive (where artificial heat is not employed), comparatively with the usual price of new potatoes early in the season. Hogs, if hungry, will eat the old tubers when the young have been taken away; but those probably contain but little nutriment, and their value, therefore, may not be worth calculating.

“ Two early varieties only of potato have been the subjects of the above stated experiments; but there does not appear any reason to doubt that similar success may be obtained with all other early kinds.”

3. *On raising Apple Trees from Pips.* By the Rev. James Venables, C.M.H.S. Read Dec. 1. 1829.

Mr. Venables says, he has never found any satisfactory reason “ why the pips of our best apples should produce most frequently trees little better than a crab.” We will answer him by stating that this is not a matter of fact; the pips of our best apples will most frequently not only produce good apples, but apples more nearly resembling the parent variety than any other variety, and never to be mistaken for the seminal produce of the crab. Let any one take the pips of a golden pippin, a Ribstone pippin, a nonpareil, and a Hawthornden, mix them as he will, and sow them together; and, when they have come up, rear them till they shall all have borne fruit; and we will engage that any person, who knows the apples named, will be able to refer every seedling to its parent. Any one who has

had a little experience in raising apples from seed knows this to be fact; and, indeed, if it were not so, the general analogy between apple trees and other vegetables would not be complete.

“It would seem,” the author observes, “that much of the peculiar flavour of fruit depends upon the leaf; and whatever determines the first organisation of this member of the tree, must have considerable influence on its produce.” The naked apple pip, he thinks, contains too little of the saccharine pabulum for the future tree. It was intended that the decaying apple should supply this pabulum; and it is, therefore, suggested that the pip, when it is sown, “should be inserted in fruit of the same kind, or in mould enriched by an admixture of decayed apples.” The advice is rational, and it would be very desirable to institute an experiment to determine the comparative results of the practice. The reverend author states, that, a few years ago, he put some apple pips into the same furrow with a quantity of decayed apples, and that the fruit of the seedlings thus raised has been of good flavour; but this may be from the parentage of the seedlings, independently of any other cause.

4. *Upon the Cultivation of Epiphytes of the Orchis Tribe.* By John Lindley, Esq. F.R.S. &c., Assistant Secretary. Read May 18. 1830.

This class of plants is comparatively new to Europe, having been generally speedily lost after their introduction. The *Vanilla* seems to have been almost the only species that was known in England in the time of Miller, and little more than twenty were to be found in the Kew Garden during the last ten years of the last century. Not more than twelve or fourteen species had been added to the same garden, in the first thirteen years of the present century; and only nineteen species are mentioned as in the Berlin Botanic Garden, one of the richest in Europe, in 1822.

It was supposed that this want of success was owing to some peculiar difficulty in their cultivation; and it was therefore resolved that an attempt should be made to overcome this difficulty, in the Chiswick Garden. Similar attempts, before or about the same time, were made in the stoves of Messrs. Loddiges of Hackney, Messrs. Richard and Arnold Harrison of Liverpool, Mr. Cattley of Barnet, and others; so that the total number of species of this family of plants found in Britain at the time Mr. Lindley's paper was read, was not less than 200; while the catalogue of the Paris Garden, made up to 1829, enumerates only nineteen. We may

add that Messrs. Loddiges have now (Dec. 1831) above 300 species.

The result of various experiments to ascertain the best soil and climate for these plants may be said to amount to this: — “That a well-drained soil, shade, a very high temperature, and an atmosphere nearly saturated with humidity, are the conditions that are requisite to insure their successful cultivation, and that soil itself is of little importance to them. We have used common garden earth, lime rubbish, gravel, decayed vegetable matter, and moss, and all with equal success, provided the drainage was effectual; and we have found all these equally useless when the drainage was not attended to; a circumstance which is, no doubt, due to the succulent nature of the plants, and to the very imperfect means that most of them possess of parting with superfluous moisture: in consequence of the compact nature of their cuticular tissue, and of the minute size, or small number, of stomata or evaporating pores. We have found that no soil or temperature would nourish them in drought, and that any soil was good when the temperature and atmospheric humidity were carefully regulated. To speak very accurately upon these points, I should say, that the mean temperature of the day ought to be 87° or thereabouts, and that its humidity should be at the point of saturation, or nearly so. We have found that the same plants which refused to grow when placed upon the stage of a hothouse, the air of which possessed the necessary conditions of heat and vapour, flourished with all their native luxuriance, if the pots, in which they were planted, were suspended freely by wires from the roof; a difference which, no doubt, depended essentially upon drainage; and we have seen that moss alone would, under these circumstances, maintain in perfect health plants which the most carefully managed soil appeared to kill, if the humidity of the air and the drainage were unattended to.

“Having originally taken great interest in this enquiry, I have for some years been collecting information relating to it, and I find that if we had had, in the beginning, the same knowledge of the native habits of orchideous epiphytes that we now possess, those conclusions, that are now the result of many years’ careful and expensive enquiry, would have been obvious inferences prior to any experiments whatever having been instituted. The facts that I have collected are the following: —

“Orchideous epiphytes grow naturally upon trees, in the recesses of tropical forests: they establish themselves in the forks of branches, and vegetate amidst masses of decayed

vegetable and animal matter. In consequence of their position, there cannot possibly be any accumulation of moisture about the roots. They will also grow equally well upon rocks and stones in similar situations. Mr. W. Harrison of Rio Janeiro is mentioned by one of the Society's collectors, who visited him, to cultivate, with the most perfect success, above seventy species upon a wall in his garden at Boto Fozo.

"We see some of them germinate and grow most luxuriantly in damp places, in the stove, upon the sides of the garden pots, and among gravel; and Dr. Wallich found them in all cases growing equally well upon trees and stones, provided the latter had a certain quantity of mould and moss adhering to them.

"In the Botanic Garden at Calcutta they are cultivated with success in raised beds of solid brickwork, so contrived as to secure the most perfect drainage; the soil being rich vegetable matter, mixed with at least two thirds small pebbles, and covered with a dense layer of moss.

"Shade seems essential to them; their natural situation being in deep forests, or among the branches of growing trees. In Brazil they exclusively occupy damp woods and rich valleys, among vegetation of the most luxuriant description, by which they are embowered. In Nipal, I learn from Dr. Wallich that orchideous epiphytes grow in company with ferns; and the thicker the forest, the more stately the trees, the richer and blacker the natural soil, the more profuse the Orchidæ and ferns upon them. There they flourish by the sides of dripping springs, in deep shady recesses, in inconceivable quantity, and with an astonishing degree of luxuriance.

"In the Botanic Garden at Calcutta it is found that they thrive best under the shade of trees with dense but airy foliage, such as mimosas, especially the *Acacia stipulata*, the huge stem of which is the more remarkable when compared with the myriads of minute leaflets by which it is formed.

"High temperature and excessive humidity are together the other conditions essential to the well-being of these plants. The hottest countries, if dry, and the dampest, if cool, are destitute of them; while there is no instance of a country, both hot and damp, in which they do not swarm. This can readily be shown."

They are most abundant, in India, in the Malayan Archipelago, the mean temperature of which is between 77° and 78°; and the air is damp to saturation. In Nipal they are only found upon the sides of the lower mountains, where they vegetate among clouds and constant showers. On the continent of India they are almost unknown; because there,

though the mean temperature is 80°, the air is dry. In the Calcutta Garden, they grow vigorously in the rainy season, and perish in the hot season. In the hot humid climate of the Isle of France and Madagascar, they exist in vast quantities. In Africa they are rare, except at Sierra Leone, where the air is moist as well as hot; at the Cape they are wholly unknown.

“In America, their favourite station, according to Humboldt, is in the gorges of the Andes of Mexico, New Granada, Quito, and Peru, where the air is mild and humid, and the mean temperature 63° to 67° Fahr. (17° to 19° cent.). In these localities they are so abundant, that, according to the authors of the *Flora Peruviana*, above 1000 species might be found in Tarma, Huanuco, and Xanxa alone. They are not seen farther north than Florida, where a single species, *Epidéndrum conópseum*, is found on the *Magnòlia*; but it is well known that the vicinity of the Gulf of Mexico, and the effects of the Gulf Stream, give the vegetation of Florida a tropical rather than extra-tropical appearance. In that country this solitary representation of tropical *Orchidéæ* exists in the same region as myriads of *Tillándsia usneoides*, which usually vegetates beneath the influence of the dampest tropical atmosphere.”

In the West Indian Islands, particularly in Jamaica and Trinidad, and on the lower ranges of hills more especially, they are abundant. At Rio Janeiro, where the woods are so damp that it is difficult to dry plants, orchideous epiphytes are found in inconceivable multitudes; but at Buenos Ayres, where the air is dry, they are unknown. In the high dry land of Mendoza, the aridity is still greater; and there the whole order of orchideous epiphytes almost entirely disappears. On the west coast of South America, they are unknown as high as Lower Peru; the whole of that region being extremely arid, with the exception of a few valleys. There are two species of *Orchidéæ* found in the Mexican Andes, which are exceptions to the general conditions for the growth of the order; two species in Japan, which will grow in a low temperature; and some in New Holland, which thrive in a mean heat of 66° 6’.

From these facts, Mr. Lindley thinks those conditions of culture might have been safely deduced *a priori*, which were arrived at in the Chiswick Gardens experimentally. He is persuaded “that if these facts are carefully borne in mind, we shall no longer experience any difficulty in the cultivation of orchideous epiphytes, and that the time is not distant when the beauty of the dendrobiums and bolbophyllums of India, of the oncidiums of the West Indies, the aerides of China, and the epidendrums of Peru, will add a charm to every hot-house.”

(To be continued.)

ART. II. *Memoirs of the Caledonian Horticultural Society.*
Vol. IV. Part II.*(Continued from p. 187.)*

63. *On heating Hot-houses by Steam.* By the Rev. James Armitage Rhodes, Horsforth Hall, near Leeds, Sept. 22. 1825. Read Dec. 7. 1826.

THIS paper, modified a little, appeared in this Magazine (Vol. IV. p. 330.).

64. *Account of a Mode of training Vines on the Outside of the alternate Sashes of a Hot-house, by which means excellent Grapes were produced.* By James Macdonald, Dalkeith Park. Read Dec. 7. 1826, and Jan. 4. 1827.

These grapes are from vines which were trained over the sashes of a glazed hot-house; they were well swelled, and of the richest flavour, the summer and autumn of 1826 having been peculiarly favourable for ripening fruits.

The vines had been "planted about fifteen years, outside of a small stove for the cultivation of tropical plants. The vines have generally been brought into the stove every spring, and trained up to the rafters to produce their fruit; and in the autumn, when the fruit was matured and cut, the vines were turned out to the open air to winter.

"But for these two or three years past, in the spring, when the vines were introduced into the house for a crop, I left some of the short wood on the vines outside in the open air; and I found that they matured their fruit every year, equal, both as to size and quality, to those within the house. This year (1826), all the rafters in the stove being covered with choice ornamental creepers, I was induced to make a trial of my whole vines in the open air outside. Accordingly, in the spring, when the buds began to swell, I laid the whole vines down on the ground; and, to preserve them from the spring frosts, I covered them over with mats and spruce fir boughs, till the end of May. I then trained all the shortest vines on the front ashlar wall [a wall made of freestone as it comes from the quarry], which is about 2½ ft. high, filling in as many as it could contain. I then took the longer shoots, and trained them up the front upright rafters, keeping the upright front glass clear. I next procured some very thin laths, and tacked them on each alternate fixed light on the sloping roof, so as not to prevent the running lights from giving the usual air for the house and plants. We tied the vines to the laths as we went along. They remained in this state till the end of August; when I found that those vines on the sloping glass were not making such progress as those on the front ashlar building, or on the front upright rafters, the fruit not swelling equally well. With a view to remedy this, I and one of my young men got a few blocks of wood, 5 in. high and 1½ in. in width, and nailed them upright on the centre of the long rafter, 2 ft. 3 in. apart, on each alternate light; we got long laths, and stretched them along these blocks, in the direction and according to the slope of the sashes, nailing the laths to the blocks. Then we began at the bottom of the light, and got some small laths to reach across the light; we nailed our stretchers on the top of the laths, and then lifted up the vines and grapes on the top cross-stretchers, tying and regulating them as we proceeded. The cross laths are placed about 18 in. asunder: thus placing them about 7 in. above the rafter, and about 10 in. above the glass. This finished the operation.

“ In a short time, the progress made by the grapes in swelling was quite visible ; and, at the same distance from the glass, they remained till ripened in October and November.

“ The kinds of grapes are, Black Hamburgh, Black Burgundy, Green Chasselas, White Constantia, White Muscat of Alexandria, and Black Gibraltar.”

65. *Another Hit at the Caterpillars.* By Mr. Mackray, Annat.
Read June 5. 1828.

Insulate the trees or bushes by surrounding them with a small moat of water, retained by an annular canal of tempered clay. This will prevent the spread of the caterpillars from one bush or tree to another.

66. *Of the Disease in Turnips called Anbury, or Fingers and Toes.*

Queries were circulated for information on this subject, in 1819 ; and five communications in answer were received.

Mr. Sinclair, formerly of Woburn Abbey, now of the New Cross Nursery, has observed the galls or tubercles on turnips since ever he had any knowledge of the culture of the plant. He has observed the effects of the disease upon plants about seven weeks old, but not earlier. When the plant is taken up, and the gall opened, it is found to contain the larva of an insect, sometimes not large enough to be distinguished by the naked eye. As soon as the larva becomes in a fit state, the gall begins to putrefy.

“ The exerescence becomes soft and spongy, the rind bursts, and a fetid smell, peculiar to decomposing vegetable matter, exhales from it. Partridges appear to be very fond of the larva : whenever they are seen to congregate among affected turnips, the galls are found perforated, and the insect taken out. Several insects are now attracted to the putrefying mass ; a species of *Múca* [fly] deposits its egg on the surface. The larvæ burrow in the mass ; these are followed by different species of *Staphylinus*, *Pæ'derus*, &c. The former of these seem to live on the larvæ of the *Múca* ; for two of these lived three months, while supplied with these larvæ, but died soon after the supply was discontinued. They did not appear to touch the matter of the turnip, on which the larvæ of the fly lived. Under these circumstances, when moist weather occurs, the mass affected soon wastes away, and frequently a large root is found a mere shell. The larvæ are found solitary : how great a number soever inhabits a root, every individual occupies a distinct cell. It appears to be a species of the *Cýnips* of Linnæus ; and the *Diplolopariæ* of Leach, Geoffroy, &c. In the head, mandibles, jaws, &c., it is similar to the larvæ which live on the root of the cauliflower, broccoli, and other varieties of *Brássica Napus* and olerácea. The colour of the larva varies according to the colour of the root : it is white in the common field globe turnip, and in cauliflower ; yellow in the root of rape, and Swedish turnip, Scotch yellow, &c. The latter appear to be less subject to the disease than the white globe and tankard varieties. In two instances where I collected specimens of severely affected roots, and also of the soil, for chemical examination, I found the roots had been in contact with a portion of tree leaves, which, probably,

had come with the manure; but, in other instances, I found roots equally diseased to which no manure had been applied. In some experiments instituted by his Grace the Duke of Bedford, which I have had the honour to conduct, on the nature of salt as a manure, simple, and combined with other substances, as stable-dung in different states, lime, soot, oil-cake, &c., applied in different modes, and in various proportions, to soils differing essentially from each other in their natural properties, as loams, siliceous sandy soils, clayey soils, peats, and heath or moor soils, for the growth of the different useful species of agricultural plants; the results, as it immediately regards this particular affection of turnips, have not been so decisive in favour of salt or lime as I had anticipated; for the disease appeared in every case, though in different degrees. Combinations of salt and lime were evidently the most effectual, as no instance occurred of the bulb being affected below the surface of the soil. That portion of it, however, which was above the surface was affected with galls, the same as in the bulbs grown on soils of the same nature, to which no application of manure had been applied. On a space of the same soil, to which salt simply had been applied the preceding spring, and from which time the soil remained fallow, the crop was good. One plant in ten, however, was affected with the disease below the surface as well as above it. The salt in this instance had been applied at the rate of 86 bushels per acre, and mixed with the surface 4 in. deep; it was applied in the first week of May, 1818. On one portion of it barley and turnips were sown, but they did not vegetate, the dose being too great. The season following, however, the crops were good. On the same soil lime was applied at the rate of 120 bushels per acre, and the disease was not less general than in the former case. Lime was applied to a clayey loam, and to siliceous sandy soils, at the rate of 120 bushels per acre to 25, and salt from 86 bushels to 5 per acre, but without any decisive effects in the prevention of this disease of turnips. The maximum and minimum of salt were here nearly ascertained. In every distinct soil, the quantities applied were the same, and the trials made under the same circumstances. With regard to the mode of applying salt and lime for turnips, that of mixing it with the soil, previously to sowing the seed, or applying it to the surface after sowing, proved best; for, when salt and lime are mixed, and deposited with the seed, vegetation is retarded from two to twelve days, and more, beyond the natural period. This fact was proved on the seed of eight different species of plants, sown on four different kinds of soil. However beneficial, therefore, salt or lime, in other respects, is to the soil (a subject not within the present enquiry), and though they seem, when combined, to modify this disease, yet it appears they are not, either in a simple or combined state, a specific remedy for this disease in turnips. . . .

“ I have procured seed from roots perfectly free from this disease, sowed in a situation excluded from the neighbourhood of any other species or variety of *Brássica*; which, when sown on land that, to my knowledge, never was sown with turnip seed before, and on old garden land, in both cases produced bulbs more or less affected by this disease. Whether the reverse of this takes place, I have not had an opportunity to obtain satisfactory proofs; and until the minute particulars of the economy or natural habits of the insect, which is doubtless the immediate cause of the disease, is intimately known, it will be difficult to proceed in devising any plan of prevention, with a hope of certainty of success. One point is clear and evident, that whatever increases the vigour and rapid growth of the turnip plant, in its early stages of growth, checks with considerable force the progress and bad effects of this formidable disease. . . .

“ This disease appears to lessen the nutritive powers of the turnip, in various degrees, according to its violence.”

Arthur Young, Esq., the secretary to the Board of Agriculture, states, of his own knowledge, that the disease in turnips called fingers and toes has been known in Suffolk about fifty years. He has no idea of the cause, and never heard of any remedy.

Messrs. D. and A. Macdougall of Cessford, near Kelso, affirm that the disease has been known in their neighbourhood nearly twenty years. They think that the disease originates in the bite of some insect upon the fibres, &c.

The Rev. George Jennings, Prebendary of Ely, states that the disease in turnips called anbury has been known in the eastern part of England as far back as forty years. He conceives it to be caused by a grub forming its nidus in the bulb. "I have not traced the progress of the larva so as to ascertain the species of insect; but a small maggot or grub is visible in every excrescence upon the turnip which I have examined; in some instances, three or four very near together in the same lump. If it results from the punctures made by some insects, eggs must be deposited at the same time. I know of no remedy which has been tried to prevent this disease in the turnips."

Sir John Sinclair, having "found some notes on the subject," sends a recipe for a liquid, containing salt, tobacco, soap, soot, and lime, to be poured round the roots of each plant; and which "has been found useful in destroying the insect, if applied early, that is to say, before it has eaten its way deep into the root." We have no faith in recipes of this sort: what would penetrate to and kill the insect would unquestionably destroy the plant.

The editor of the *Farmer's Journal* has observed the anbury, or ambury (the word is borrowed from farriery, in which art it is applied to small knots or excrescences, warts or wens, on the loins or flanks of horses), only in very dry seasons. He says, it is doubtless occasioned by insects; perhaps, piercing the roots near the surface, and depositing their eggs, which, as in multitudes of other cases, produce knobs, and intercept the ascent of the vegetable nutriment (sap). If, when the disease has taken place, plentiful rains ensue, the bulbs put out other roots (or, more properly speaking, other fibres enlarge) to supply the places of those which are wounded.

67. *An Account of some Seedling Apples and Plums which have been raised at Coul, in Ross-shire.* By Sir George Stuart Mackenzie, Bart. Read Dec. 26. 1826.

See the Horticultural Society's *Catalogue of Fruits*, 2d edit.

68. *On Canker in Fruit Trees, depending upon bad Subsoil.* By Mr. Peter Campbell, Gardener at Coulston, East Lothian.

Mr. Campbell agrees with various other gardeners in "thinking that canker is owing to a stintiness that takes place in the trees from a bad subsoil." He found the trees under his care rooting down into a sand mixed with some clay of a reddish colour, and interspersed with veins of sand as black as ink. He found the roots that went into this black sand quite swelled and overgrown; and, on examining the inner part of the wood of the root, he found it of an iron colour, and very hard. He then set about removing the surface soil to the depth of 18 in., and for the space 3 ft. all round the tree; he then cut the tap roots that went right down.

"I then made two cuts opposite each other, as low as the under part of the trunk, so as to place a beam of wood across below the trunk, and to prevent it from sitting down or sinking, owing to its being so much hollowed out below. I then cut off all the roots I thought diseased, and cleared the mould out another foot's distance, which was 4 ft. out from the trunk all round. Having no flags, I floored the pit I made below the roots with bricks and large slates laid close together, so as to prevent the roots from entering into the black sand again; and formed the flooring of a concave form rather than even or level, so as to make the roots or young fibres incline upwards, which is a great means to prevent the roots from entering so soon into the subsoil. I mixed good mould with very rotten cowdung, and filled up the pit with it; at the same time beating in every course below the trunk of the tree with the end of a beater made for the purpose, so as to prevent the tree from sliding down too hard on the beam of wood. . . .

"The second operation is the pruning of the tops of the trees. I commenced on one side of the trees, and pruned regularly round, cutting off all the cankers, not leaving one branch or bit of wood that had a canker in it on any of the trees. In some of the trees I pruned two thirds of the wood; others I pruned, leaving only one fifth part of the wood; which operation was executed according to the state the tree was in.

"By this treatment, the trees are become quite healthy, and free from any moss or lichen; and not the least appearance of a canker, where formerly every year's growth cankered the second year, and had done so, as far as I could observe by numbering the growths or shoots, for ten years back. I have done espalier, wall, and standard apple trees in the mode before stated; and it is to be observed that all the trees, except one, are above forty years old."

69. *On the Germination of Seeds, and subsequent Vegetation.* By John Murray, Esq. F.L.S. &c. Read June 7. 1827.

There is no philosopher of the present day more active in his researches than Mr. Murray, and many of these have ended in important practical results. Mr. Murray has the great advantage of being, or having been, a practical man.

"Mustard and cress were sown on black woollen cloth kept constantly wet. The germination was tardy, the growth exceedingly dwarfish, and

the vegetation altogether sickly. Seeds from the same packets, grown on patches of white and of red woollen cloth, were luxuriant and beautiful. . . . The retardation and final suspension of the vegetation are, no doubt, to be ascribed to the iron, the base of the colouring matter in black.

“ Mustard and cress seeds were sown in powdered alum, sulphate of iron, sulphate of soda, sulphate of magnesia, muriate of soda, and muriate of lime, in small glass capsules, and duly watered; with the exception of the last, which, being a deliquescent salt, did not require it. Two cress seeds only germinated in the powdered alum, but no vegetation appeared in the others.

“ Mustard and cress seeds were partially roasted, by being projected on ignited iron; yet a great portion of them afterwards grew on wetted flannel. Seeds were likewise submitted to the action of boiling water, and the temperature suddenly reduced: all these grew. Hence, some seeds can sustain an elevated temperature without the destruction of their vitality.

“ Peas and beans, with boiling water poured on them, and suffered gradually to cool, sprouted in a few hours, and grew remarkably well, having been transferred, when cold, to wetted flannel. This experiment furnishes a very easy method of ascertaining, in a sufficiently prompt way, whether the vegetative power is suspended by age or other causes.

“ I put sprung peas into alcohol, of specific gravity 1812; but little progress was made in ten days: those placed in naphtha and ammonia decayed. Peas placed in alcohol, naphtha, and sulphuric ether exhibited no evolution of incipient germination.

“ Mustard and cress seeds were sown in iodine, dilute sulphuric acid, dilute muriatic acid, and dilute nitric acid; chlorate of potassa, hydriodate of potassa, muriate of iron, sulphate of iron, and caustic potassa: they gave no evidences of germination whatever, though they were regularly supplied with water.

“ Cress sown on carbonate of magnesia, and attentively watered, germinated freely: hence there must be some error with the late Mr. Tenant's conclusion, as this experiment is completely opposed to his deductions. It is one of first-rate importance, as many farmers have been induced, from Mr. Tenant's experiment, to discard magnesian limestone, as injurious to vegetation; though they had a supply of it at hand, and bring from a distance limestone of a different character.

“ Mustard germinated freely in the tincture of iodine, and the vegetation was fine.

“ Tufts of mustard and cress, growing on different parcels of sponge, were placed in capsules with the following solutions:—

Sulphate of iron (copperas): vegetation here fell the first victim.

Sulphate of copper (blue vitriol): this fell the second in succession.

Acetate of lead (sugar of lead): this fell the third.

Muriate of mercury (corrosive sublimate) was the last survivor.

“ Some younger plants, though nearer the surface, sustained the green colour after the tallest had fallen; but cress seemed to be the last to suffer. The vegetable matter, in each instance, was duly tested by the necessary reagents. That with sulphate of iron, after the stems had been macerated with distilled water, became decidedly blue with hydrocyanate of potassa; that with muriate of mercury was rather equivocal on being examined by caustic potassa. In the specimen destroyed by sulphate of copper, the lower parts of the stems and transverse portions, where they were cut, became of a violet tint with ammonia. The vegetable matter that had been destroyed by acetate of lead, tested with hydriodate of potassa, was not appreciable; but on being crushed in solution of chromate of potassa, the capillary vessels were beautifully dyed by the new-formed, chromate of lead.

“ These last experiments prove that vegetation is affected by the metallic poisons, sulphate of copper, acetate of lead, and corrosive sublimate, and perish under their influence. They also prove that ferruginous matter holds the first rank in these deadly poisons; and, in this respect, there is a difference between animal and vegetable life. When iron obtains in any soil, there is an enemy to contend with; and sand and lime, in due proportions, appear to me to be the only remedy: the lime decomposing the salt of iron, and the silica combining, in the character of an acid, with the oxide thus separated. Such a combination we find in the baths of Lucea, &c. The experiments also show the comparative fatality, and yield decided evidence of the passage of the substances into the system of vegetable being, and, of necessity, their consequent absorption by the roots; the young stems having been always cut above the surface of the sponge, and apart from the roots. It is not, therefore, the mere root that is affected, but the entire plant in its higher organisation.

“ Tufts of vegetation, similar to those already described, were placed in capsules with the following solutions:— Dilute nitric acid, hydriodate of potassa, and chlorate of potassa. These are arranged in their relative order as to their comparative permanence; the tuft placed in dilute nitric acid having fallen first, and that in chlorate of potassa remaining longest unaffected. The stems of that with nitric acid slightly reddened litmus paper, when macerated in distilled water; that in hydriodate of potassa gave an abundant yellow precipitate with acetate of lead; and that from chlorate of potassa deflagrated like nitre, on an ignited disc of platinum.

“ I would not, however, be supposed as inferring, from the last experiment, that, though chlorate of potassa does in quantity injure vegetation when thus applied to the roots, a small portion in solution might not occasionally be beneficial, and act (in some plants, at least) as a stimulus to vegetation. Last season, when all my carnations seemed rapidly proceeding to destruction, in consequence of the arid summer (1826), and many had already perished, I succeeded, by a few waterings with solution of nitre (an analogous salt), not only to save the remainder, but to impart to them a beautiful luxuriance of growth. The effect was very manifest, and remarkably prompt; and I now possess a hundred very beautiful plants.”

70. *Account of the Mode of Culture adopted at Cunnockhie in raising Pine-apples and Melons in a Pit heated by Steam, with a Description of the Pit and Steam Apparatus.* By Mr. Alexander Smith, Gardener to Colonel George Paterson of Cunnockhie.

The pit was erected in 1824, on a plan furnished by Mr. Hay of Edinburgh, founded on a principle of heating devised by Mr. Hay more than twenty years previous to that time. The pit contains a bed, 2 ft. in depth, of small water-worn stones, or pebbles, which are heated by pipes of steam. Over the bed of pebbles is placed a cover of Arbroath pavement, supported on brick pillars. The boiler is of copper, with a large iron pipe, which lies in the bottom along the middle of the bed of stones, and is perforated at certain distances with holes for diffusing the vapour among the stones. The bottom of what is destined to be the plant-bed is paved; but “ intervals are left between the edge of the pavement and the wall, in order to allow the steam to communicate with flues which are

filled, like the bottom of the floor, with small round stones. At short distances, on the top of these flues, are fixed small iron tubes, with caps which are removable at pleasure, to admit or exclude the steam of the flues and floor from the atmosphere of the pit, as occasion may require. The outer wall, on each side, adjacent to the flues, is built double, with a small interval between the parts; which prevents unnecessary waste of heat, and allows any heated air or steam which may escape through the interstices of the bricks to pass into the atmosphere of the pit.

The pots of pines are placed on a layer of cinders 4 in. in depth, which rests on the pavement; and the interstices around them are filled as high as their edges with tanner's bark. The pots are never moved except for repotting. The temperature of the air of the pit, in winter, is kept at 50° or 55° . About February, it is raised to 65° or 70° ; in May, to 75° or 80° ; and in autumn, while the fruit is ripening, it is kept at 65° or 70° . The plants generally fruit in the second year. The steam required to produce the winter temperature is about an hour and a half in 24 hours; that to maintain the autumn temperature, an hour or an hour and a half in 48 hours. In all cases, fire is applied to the boiler about six o'clock in the evening, and steam is procured a little before seven.

In cultivating melons in these pits, a bed of proper soil is placed over the stratum of ashes. "When the plants are put in, steam is to be applied once in 48 hours, an hour and a half at a time. A very little watering is necessary till the fruit be set; after which it is to be applied more freely. From the time when the plants appear, to the setting of the fruit, the heat is kept near 60° ; and afterwards about 65° . In warm weather, steam is required only about once a week."

Melons and pine-apples raised in this pit were exhibited to the Caledonian Horticultural Society, and very much admired; and the silver medal was awarded to Mr. Smith.

71. *Account of a glazed House, adapted for the Culture of Peach Trees, Grape Vines, and ornamental Plants.* By Mr. R. F. D. Livingstone, Planner.

The only peculiarity in this house, deserving of notice, is, that the vine-border is placed at the back wall, and within the house, in order to separate it from the peach-border, which is placed against the front wall, and without the house. The house is 40 ft. long by 16 ft. wide, and heated by one fire. On the whole, the plan seems not unsuitable for what may be called a hot-house of all work. The following is a description of its section (*fig. 54.*): —

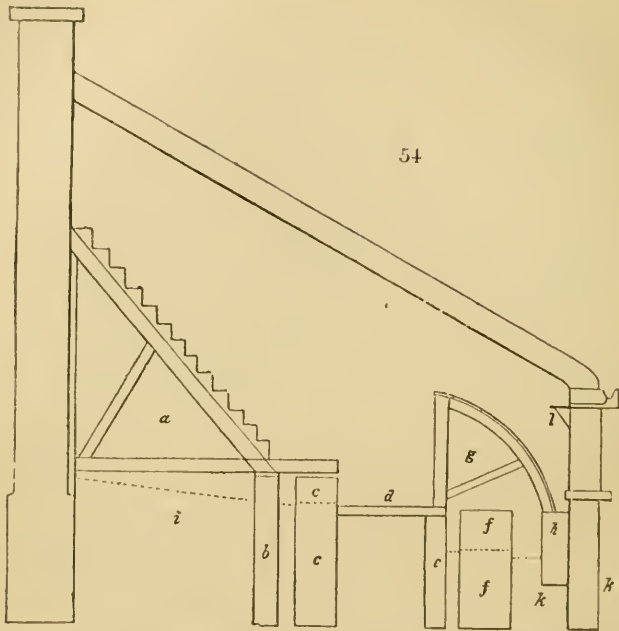

a, Stage for plants. *b*, Arched wall for support of stage. *c*, Arched wall and back flue.
d, Raised walk, or gangway, in front of stage. *e*, Arched wall for support of walk.
f, Arched wall and front flue. *g*, Peach trellis. *h*, Stone for support of peach trellis.
i, Made border for vines: it is 14 ft. wide, 5 ft. deep at back, and 3 ft. at front. Here the vines are planted against the back wall, and trained down the rafters, one branch to each, on the spur mode of pruning.
k, Peach border within and without the front wall.
l, Front shelf, for forcing strawberries, &c.

72. *Account of a Mode of producing a steady and uniform Bottom Heat in Pint-apple or Melon Pits, or in Stoves for Exotic Plants, by means of Steam introduced into a close Chamber filled with Water-worn Stones.* By Mr. John Hay, Planner, Edinburgh. Read March 5. 1829.

We have already (Vol. V. p. 443. and 450.) noticed this important improvement in exotic culture; and stated that the first idea of applying steam to the heating of hot-houses occurred to Mr. Hay about the year 1794. In 1807, a pine-stove was designed and executed for the Duke of Northumberland, at Alnwick Castle, by Mr. Hay, in which a chamber below the bark-bed was filled by stones heated by steam; but, as the pipes and supply of steam were too small for the mass of stones, the use of this mode of heating was in this instance not long continued. Mr. Hay did not, however, lose sight of the principle; and accordingly, in 1818, applied it in small pine-pits at Castle Semple, and in pine-stoves at Bargany. About the end of the year 1820, Mr. Hay says: —

“ I caused the chamber of the steam-pit, which I had erected at Castle Semple two years before, to be filled with stones, those of the larger size below, and the smaller above. About this time I entertained the idea, and suggested it to the late Mr. Harvey, that in such pits, prepared with suitable compost, the pine-apple might be cultivated in the earth without pots, as in the West Indies, by growing the plants for one year in the pit, and bringing them to fruit in the next; and so on alternately. With this in view, experiments were instituted to ascertain the difference of temperature communicated to the soil above, by the chamber without stones, and by the chamber with stones, and its duration. The result was decidedly in favour of the latter method, as it was found to retain the heat much longer than the other, as indicated by the steam-pit thermometer. So far I was satisfied with the application of the principle which I had long had in view; and, in order further to try its effects, I caused the gardener to make up a bed of suitable compost in a part of the pit, and desired him to plant in it some of the smallest pine-apple plants he had, such as the suckers from the bottom of the fruit, only a few inches high. On my return to Castle Semple, the following autumn, I was surprised to find that the plants had made far greater progress than I expected, being more than double the size their treatment by the old method warranted me to look for. I may here observe, that, if the plants will grow freely under this treatment, in such pits, I have strong hopes that, by keeping the fruiting plants under a moderate degree of bottom heat, during the winter months, and raising it considerably higher in spring, they would start regularly into fruit; and if this were found to be the result in practice, the views I originally entertained on this point would be realised. I now became fully convinced of the value and importance of this method of applying heat for the cultivation of ananas, and resolved thereafter to adopt it in all practicable cases.”

Sixty feet of pine-pits are now erected at Castle Semple; and the gardener, Mr. Lauder, states “ that the pines are as successful in the steam-pits, as in those wrought with leaves, and with only one tenth part of the expense; as, in the one case, the plants never require to be removed during the whole year, for the purpose of renewing the heat, while, in the other case, viz. the pits wrought with leaves, they require, he says, to be turned over, and new leaves added five times in the year; and it takes seven men, for two days each time, to perform this operation, that is, on the two pits. He states, also, that it is his intention this spring (1829), as I recommended two years ago, to plant one half of one of the steam-pits with plants, not in pots, but in a bed of soil made up for them, and to fruit them the summer after the next. The steam, he says, is admitted into the chamber, among the stones, only an hour and a half every forty-eight, which he finds to be quite sufficient to keep up the bottom heat as high as is necessary. During the winter, he has not admitted the steam for so long a period, having only kept the heat to the bottom of the pots from 75° to 80°; but now, as he wishes to start the plants into fruit, he intends to raise it to 90°.”

The following description of a plan and section of a set of pits, erected, in 1824, for Colonel Paterson, Cunnoquhie, for the growth of melons, but which will serve equally well for that of pines, or other hot-house plants, is dated March, 1829: —

“ The same letters of reference apply to the corresponding parts, both in the ground plan (*fig. 55.*) and the section (*fig. 56.*)”

55

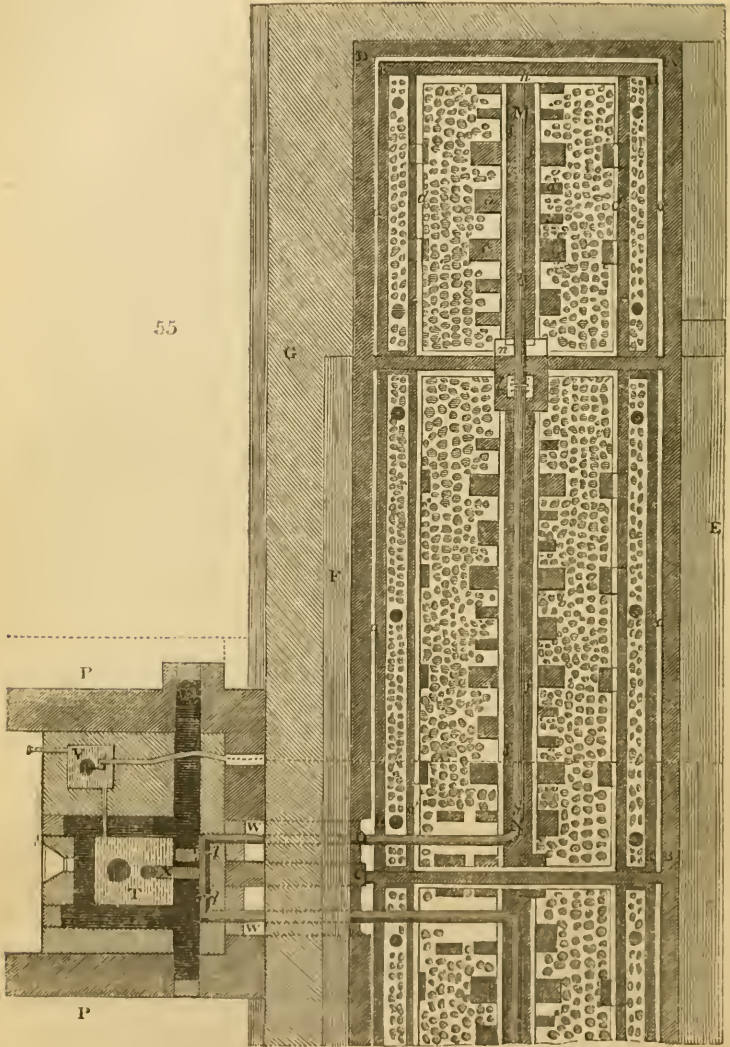

“A B C D, The external walls of the pits, built of droved ashlar, 8 in. thick. In the upper course of ashlar, on both sides, are gutters for carrying off the rain-water from the roof sashes. The drawing is 10 ft. over the walls.

“E, An elevated walk, with steps, on which the gardener may stand with ease, and do any work in the pits. F, a step for the same purpose. G, a paved or gravelled walk.

“H I K L, Wall of steam-chamber 4½ in. thick, of square stock bricks, closely jointed with Roman cement.

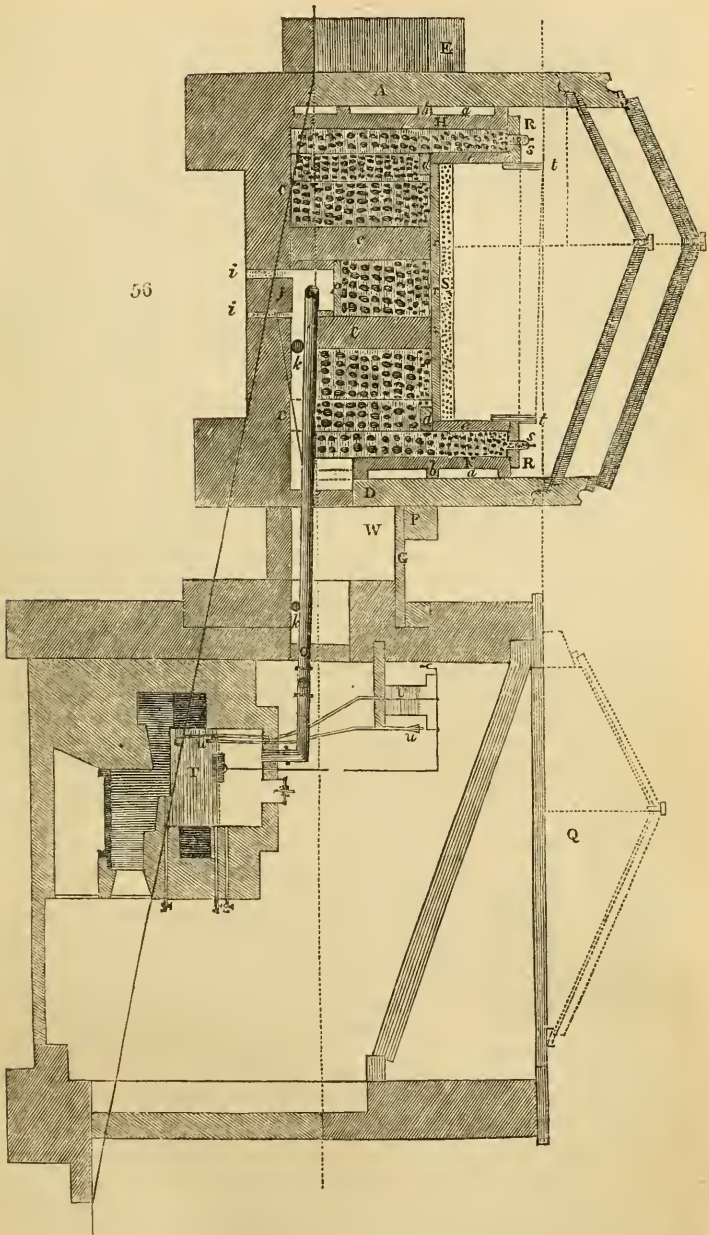

" a a, Open space $1\frac{1}{2}$ in., between the inside of the external wall and that of the steam-chamber; the projecting parts (b) in the section being the

ends of brick built out of the walls of the chamber in an irregular manner, so as to touch the outer wall, for the purpose of strengthening the inner one; but these must not be so numerous as to prevent the heat from rising and diffusing itself freely through the pits.

“*c c*, Brick pillars, 9 in. square, supporting the cover of the steam-chamber, &c.

“*d d*, Pieces of rough flags, 6 or 7 in. broad, and 3 thick, linteling over the open space between the brick pillars, and supporting the inner wall of the steam-flue *e e*. This wall is 3 in. thick, built of stock bricks, and closely jointed with Roman cement. The depth of the plant pit is 20 in.

“*f f*, A course of bricks, 9 in. broad, for the seat of the steam-pipes. On each side of this is a gutter 3 in. broad, and the same in depth; the floor of the steam-chamber has a rise of 3 in. on both sides, from the edge of the gutters to the outer walls; and is paved with hard common bricks laid in lime. The upper bed of the lintel (*d d*) is 2 ft. 10 in. in height, above the floor of the pit at the wall.

“*m n o*, Cast-iron steam pipes, of 3 in. bore (in some cases they are 3½ in.), on the opposite sides of which, a line of half-inch holes (*g g*) are bored at 2 ft. distance from each other, in quincunx order: there is thus one hole for every foot of pipe in length.

“*h h h*, Cisterns cut out of solid stone, 6 in. square, and 6 deep, having grooves a quarter of an inch deep on the top of the opposite edges at the gutters. As the ground on which the pits are built falls from east to west, the condensed steam in the east division of pipes returns into the boiler; but, as on the west it cannot do so, pieces of pipe three fourths of an inch bore, and 4 in. in length, are cast on the under side of the steam-pipe at *h h h*, in the west division. The condensed steam passes through these pipes into the cisterns, and flows over into the gutter, as does also the condensed steam from the chamber, and is carried off by the small drains *i i*.

“*k k*, Cast-iron rollers in frames, on which the pipes rest, the under part of the pipes being 2½ in. above the brick seat.

“*l l*, in *fig. 55.*, and in *fig. 57.*, are slide valves or cocks, by which the steam is admitted at pleasure into the pipes of the melon-pit. The draw-rod passes through an oblong opening in the cover *m*, which is of polished Arabroath pavement, and the opening is covered over with an oblong piece of brass about five eighths of an inch thick, secured to the stones by bats and screws. This piece of brass has also an oblong opening, through which the rod of the valve passes to the outside of the plant-pit, and is of such length as to allow for the elongation of the iron pipes when heating, and their contraction in becoming cold. On the surface of this piece of brass is placed another, furnished with a stuffing-box, through which

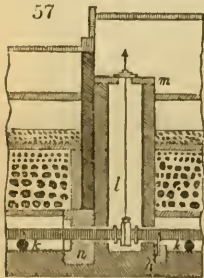

the rod passes, and keeps it in its place. Both are fitted close to each other, and kept down by a leaden weight; and thus the escape of steam from the chamber below into the atmosphere of the pit is prevented. After this simple apparatus has been adjusted, the cross handle of the rod is fixed on with a screwed nut.

“*n*, A stuffing-box, made of two pieces of sandstone, batted together, with a circular cast-iron cover bolted to the stones; the box is stuffed with lint and a little tallow, to prevent the heat and steam from passing from the one pit into the other. The pipes being laid, small brick pillars (*o o*) are built on each side, about 5 in. higher than the upper side of the steam pipe. These pillars support pieces of rough flags (*p*) in the section, cross-

ing the pipes, with openings left between each piece. The pillars must be so placed that they shall not intercept the steam issuing from the blow-holes. This cover prevents any pressure of the stones upon the pipes. Were this not attended to, the repeated motion of the pipes among the stones, in expanding or contracting, would soon shake or rend the whole building. The first three layers of stones at the bottom of the steam-chamber are $4\frac{1}{2}$ to 4 in. in diameter; they are then gradually reduced from 4 to $3\frac{1}{2}$, 3 to $2\frac{1}{2}$ and 2 in.; the layers near the top are about the size of hen's eggs, those above about the size of pigeon's eggs, and the levelling rows at the top that of large marbles.

"The covers (*r*) of the steam-chamber are of Arbroath pavement, $2\frac{1}{2}$ in. thick, half-checked on each other, and laid down so as to rest upon the top of the pillars *cc*, pressing gently on the small stones below, and closely jointed with Roman cement. Where proper flags cannot be procured, some of these pits have been covered with checked bricks made of fire clay, 18 by 9 in., and laid on cast-iron rafters.

"The covers of the steam-flues (*rr*) are laid in the same manner; they are $2\frac{1}{2}$ in. thick, and let into the sides of the flues with a half-inch check.

"*ss*, Cast-iron steam-tubes, with lifting covers; the tubes are $2\frac{1}{2}$ in. diameter, by the same in height. On the bottom of the tubes, a square piece is cast, which is sunk into the top of the cover of the steam-flue, and fixed with lead. By lifting the covers of the tubes, the steam, which is greatly modified before it reaches them, will emit a moist heat to the plants, and even raise the temperature; and, by replacing the covers, the heat will be immediately withdrawn.

"*s*, Represents about 4 in. of furnace ashes.

"*tt*, A movable piece of wood, to raise the bed of earth for the plants near the glass, if required.

"*t*, Boiler, with gauge cocks and safety valves, &c.

"*uu*, The alarm pipe dipping in the boiler a little below the lowest gauge cock. Should any accident prevent the regular supply of the boiler with water, as soon as it has evaporated to this level, the steam rushes up the pipe, producing a loud whistling noise, and giving notice to the gardener that his attendance is required to the boiler.

"*v*, Feeding cistern, with hydrostatic balance and valves. I may mention here, that steam, at a moderate pressure, of from 1 lb. to 2 lbs. per square inch, is, in my opinion, better adapted for the purposes intended by these pits than steam at a higher pressure.

"*v*, Cistern and ball-cock for supplying the boiler, having a waste-pipe, about three fourths of an inch higher than the water stands in the boiler, with a cock which drains both the cistern and the boiler, when it is necessary to clean them. It was first designed to supply the boiler of the steam-pits at Cunnockie by a feeding apparatus; but it was afterwards thought that the gardener would manage it with more ease, if it were supplied with water from a small cistern connected with it on the same level, and the cistern fed by a properly constructed cock, and half globular ball; the steam being thus blown upon the stones in the steam-chamber at the atmospheric pressure.

"*ll*, on the ground plan, Slide valves or cocks. The case of the valve is of cast-iron, with a brass slide fitted into the inside, and a stuffing-box, and cross-headed handles. These valves admit the steam into either of the pipes at pleasure, or into both at the same time; and when this is the case, that there may be a sufficient supply of steam for both, the bore of the pipe (*x*) is made 4 in.

"The furnace being finished, and the pipes laid, the passages for the pipes into the pits *ww* are firmly stuffed with dried moss, and two pieces of stone are prepared to fit the circumference of the pipes, leaving no more

than room for their expansion. These being put in, the openings left for introducing the pipes are built up.

“ The section of that part of the pits to be used for the culture of pine-apples is 10 in. higher, both on the south and north, than that for melons. The glass roof consists of two sashes, with a ridge-tree between them $1\frac{3}{4}$ in. thick, to which the rafters are fixed, and the upper ends of the sash-stiles hinged. The hinge crosses the top of the ridge at the height of the sash, having a joint on each side, with movable pins; the middle part is screwed to the ridge, and the tails to the middle of the sash-stiles, before the cope or upper part of the ridge-tree is fixed on. The front or south sash is made more than double the length of the north one, that the influence of the sun's rays may reach the back of the plant-pit. The sashes are 2 ft. 3 in. broad.

“ The rafters are $1\frac{1}{2}$ in. thick between the sashes, and continue at this thickness for fully a quarter of an inch above the sides of the sashes. They are then reduced on both sides three eighths of an inch, the remainder being six eighths of an inch thick, and $1\frac{1}{4}$ in. high, with a cope on the top of it, which is mitred into the cope of the ridge-tree. This forms a place for receiving wooden shutters to cover the glass at night in winter. To the under part of the rafters, at the height of the wall-plates (which are 2 by $4\frac{1}{2}$ in.), are nailed pieces of deal $1\frac{1}{8}$ in. thick, and broader than the rafters by 1 in. on each side. At the bottom these are checked into the wall-plates; and, together with the wall-plates, form the rest for the under side of the ashes. On each side of the rafters, near the bottom, and to the edge of the sash-rest, an iron stay is screwed, having a hook at the upper end, and moving on the screw-nail with which it is fixed. An iron eye is screwed into the edge of the rest for the hook to enter. On the under side of each sash-stile other eyes are screwed, and so placed, that, when the sashes are opened and the end hooks of the stays placed in them, the gardener may have headroom to do any work in the pits. All the sashes at the bottom are furnished with iron handles. Air is given by tilts in the common way.

“ It will be found that there is a sufficient degree of bottom heat in the plant-pits either for the culture of ananas or melons, and other plants; the flags at the bottom (*r*) and the sides (*c c*) of the plant-pits, being all in contact with a mass of heated matter, which is excluded from the action of the external air. It will also be seen that there is a sufficient degree of heat for the atmosphere of the pits. Take, for instance, the end division, or melon-pit: the depth of the steam-chamber is 3 ft., the plant-pit is 1 ft. 8 in., and the breadth of the cover of the flue is 1 ft. 2 in.; making together 5 ft. 10 in.: the length of the chamber wall on both sides is 9 ft. 6 in.; together equal to 19 ft. This, multiplied by 5 ft. 10 in., gives 111 superficial feet nearly. The end of the chamber wall is 8 ft. 4 in., which, multiplied by 3 ft., the depth of the chamber, gives 25 ft; both together making nearly 136 sq. ft. of surface in close contact with a mass of stones heated to about 170° . But should this be found to give out too little heat, a considerable increase may be obtained by making the steam-flue return on each end of the pits as some of them have been built; or, if a drier and greater degree of heat be required than that given out by the brick wall of the chamber, this may be easily accomplished by constructing the chamber wall either of Arbroath pavement, or the kind found in the neighbourhood of Dundee, which is still better adapted for the purpose, as it is not only very hard, and impervious to moisture, but may be got of any suitable dimensions. In constructing the chamber of these materials, two flags, of 4 ft. 10 in. long and $3\frac{1}{2}$ in. thick, may be set up on end, the height of the chamber and flue, and two others of any length laid horizontally between them, and so on, till the chamber is completed. They will require

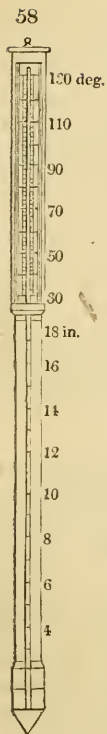

no other work than to be properly *joggled* into one another, and jointed with Roman cement. This will give out more heat, and less moisture, than the brick walls, but will not retain the heat so long. The open space (*a a*) round the pits must be kept clear of rubbish, which may be done by the covers of the steam-flue being made broad enough to cover it, and neat oblong cast-iron lifting ventilators, *in frames*, 10 in. long, and $2\frac{1}{4}$ in. broad, inserted at every foot's distance, into the cover of the flue above the open space. In this manner, the heat from the sides of the chamber may then be given or withheld at pleasure.

"It is of importance, in the management of steam-pits, to have a thermometer so constructed as to render it easy to ascertain the temperature at the bottom of the earth, or pots, in the plant pit. An instrument adapted for this purpose is represented in *fig. 58.*: the ball and stem are protected by a brass case, the upper part of which is composed of two tubes, cut open wide enough to show the scale; the outer one turns round by the hand, and encloses the scale, to protect it when the plants are watered with the syringe."

The *Caledonian Horticultural Society* voted to Mr. Hay the London Society's medal for 1828, for this improvement. It may, unquestionably, be considered as the best mode of applying steam as a bottom heat; and when it is considered that, instead of the large pipes of "3 in. bore," employed by Mr. Hay as mains or conductors, gas pipes of half an inch in diameter will do just as well, this may be considered as perhaps the very cheapest mode of heating hot-houses, or pits on a large scale, hitherto devised. It has also the great advantage of conveying the heat to any distance from the boiler or source, more especially if the latter be placed in the lowest part of the grounds on which the different houses or pits are arranged. For a single house, or two or three houses on one and the same level, the circulation of hot water from an open boiler, by the siphon or level mode, will consume less fuel; and Mr. Perkins's mode will occupy less space; but neither of these modes will equal in economy the circulation of steam in small pipes. As a proof of this, we may refer to the extensive arrangement of pits in the Bristol Nursery, all heated on this principle; and to Messrs. Cottam and Hallen of Winsley Street, and Messrs. Walker of St. John's Square, Clerkenwell; both of which firms employ this mode of heating, where circumstances render it the most advisable. Indeed, it is one of the most creditable circumstances connected with these firms, that they are not wedded to any particular mode, but adopt whatever they consider best suited to the particular case.

We may just observe that we saw, in the summer of 1831,

Mr. Hay's mode in operation for early cucumbers, at Mr. Roskell's, at Gatacre, near Liverpool; and at Bargany and Castle Semple, for pine-apples; and we were perfectly satisfied of its efficiency. The pine-apples which were planted out in the soil at Castle Semple did not appear to show fruit so soon as those in pots; but that was to be expected, and has nothing to do with the mode of heating.

ART. III. *Verhandlungen des Vereins zur Beförderung des Gartenbaues in den Königlich Preussischen Staaten. Transactions of the Society for the Advancement of Gardening in the Royal Prussian States.* 4to. Vol. III. Berlin, 1827.

THE present volume contains a number of translations from the London Horticultural Society's *Transactions*, which we shall pass over, as well as all the papers of local interest, and those containing nothing but what is already generally known among British gardeners.

1. *On the Construction of Hot-houses.* By M. Otto and M. Schram.

Houses for keeping plants, such as green-houses, pits, stoves, and conservatories, are first treated of; and, next, forcing-houses. The article is of great length, very elaborate, and illustrated by numerous figures. Transportable forcing-houses are recommended for forcing cherries, plums, peaches, apricots, &c.; because these fruits are found better-flavoured, when matured on trees that have not been transplanted the same season, as is the general practice in Holland, Germany, and Denmark. (See our account of the mode of forcing at Hylands, Vol. III. p. 385.) The fruit trees designed for being forced are directed to be planted close together, that they may be covered with more facility. When the trees have been forced once, they are allowed at least two years of rest. The houses are of the usual British form, with boarded backs instead of walls of masonry, and with cast-iron fire-places, and sheet-iron flues.

3. *On Hibiscus fugax* Mart. By M. Seitz.

This is a herbaceous plant from Brazil. The stems die down during the winter, when the roots, being tuberous, must be kept rather dry. It grows well in leaf mould and sand, and is easily propagated by cuttings and layers of its angular stems.

4. *On the Use of Camphor in Horticulture.* By M. Droste.

Camphor is dissolved in alcohol until the latter is saturated; the alcohol is then put into soft water, in the proportion of two drops to half an ounce. Withered or apparently dead plants, put into this liquid, and allowed to remain there from two to four hours, will revive, if they have not been completely dead before being put in.

15. *On the Propagation of Vines.* By M. Fintelmann.

Cuttings are made from 1½ ft. to 2 ft. in length, and all the buds removed from them except one at the upper extremity. The shoot is then laid in the soil, to the depth of 6 in., the end having the bud being brought up to the surface. A vigorous shoot is made in the first year; and in the second year the plants, if not removed, will bear fruit.

16. *On the Preservation of Grapes and Plums.*

At Berlin, grapes are preserved by cutting the bunch when ripe with about 1 ft. of the wood, above and below the foot-stalk. The ends of the wood are dipped in hot pitch, to keep in the moisture, and the bunch is then hung up in a dry place. The Quetch plum is preserved till March by the following method:—Gather them when perfectly ripe and dry; put them in a glass jar or bottle, closely tied up, and pitched so as to exclude the air, and then bury them in dry soil 7 or 8 ft. deep, so as to be out of the reach of any change in temperature or moisture. When taken out, they must be used immediately.

18. *On shortening the Tap Roots of Trees.* By Dr. Schlechtendal.

The following principles are laid down:—

1. An injury to any one part of a plant occasions a change in the natural developement of the other parts.

2. Roots and stems are always in a certain degree reciprocally proportionate to each other.

3. The tap root does not form a part of every plant; but, where it does so, it is an essential part of that plant.

4. By shortening the tap root, one or other of the following consequences will result:—tender plants will be more easily destroyed by severe weather; all sorts of plants by dry weather, from their roots not being so deep in the soil: the wood of the timber trees will be less durable, their trunks shorter, and their heads broader and less high; and fruit trees will blossom earlier and more abundantly, and their fruit will be larger and better-flavoured.

5. To transplant trees, without injuring their roots, is diffi-

cult in proportion to the age of the tree, and the extent of the roots.

6. All transplanting ought to be done when the trees are young, and then only can the roots be cut without injury.

7. When the tap root descends into a bad subsoil, it brings on diseases in the tree.

The general conclusion which the writer draws is, that where the largest and best timber trees are an object, the seeds should be sown where the plants are to remain, and, consequently, the tap root never injured; but that, in fruit trees, it should always be shortened, to cause them to spread out horizontal roots near the surface, among the nutritive soil.

25. *On the Effect of the Frost during the Winter of 1822-3.* By M. Bosse.

Peaches and apricots were destroyed by from 15° to 20° below zero of Reaumur (2° to 13° below zero of Fahrenheit). Vines, particularly the oldest plants, were much injured. Cherry trees exuded gum more than usual the next season. Apples and pears were not generally much hurt, though some of the more tender sorts were killed. Walnuts and chestnuts were less injured than might have been expected; but *Robinia Pseud-Acacia* was killed, and even some oaks on the exposed side of the forest were split. The ground was frozen from 3 to 4 ft. deep.

28. *Extract from what passed at the Forty-fourth Meeting of the Society, which took place on Sunday, Aug. 6. 1826.*

A disease is often observed in peach trees, which occasions the shrivelling up and dropping off of the leaves in spring. This is supposed to be caused by the sudden changes in the weather checking the sap; and therefore retarding the vegetation of the tree is said to be an effectual preventive. The retardation is effected by laying bare part of the roots during the winter.

29. *On Prunus cerasifera [the Myrobalan Plum], as a Stock for Plums and Peaches.* By M. Borchmayer.

After twenty years' experience, this vigorous-growing stock is confidently recommended. One of its advantages is, that it produces no suckers. It may be propagated either by layers or cuttings.

31. *On the Use of a Mercurial Ointment in preventing the Ascent of Insects up the Stems of Trees.* By Dr. Kitaibel.

A cord is smeared with the ointment, and tied round the

stem, and over this it is said the insects will not cross. To prevent the ointment from being absorbed by the bark, tar and turpentine, melted together, may be thinly spread on a cloth, that cloth cut into shreds, and of these a fillet formed round the stem, on which the mercurial cord may rest.

(To be continued.)

ART. IV. *Catalogue of Works on Gardening, Agriculture, Botany, Rural Architecture, &c., lately published, with some Account of those considered the most interesting.*

ANON.: The Penny Magazine of the Society for the Diffusion of Useful Knowledge. London. Published every Saturday in Numbers, 1d. each, consisting of 8 quarto Pages of Matter, illustrated by Woodcuts.

Φοολς αρε κνονν βαι λοοκινγ ουισε.

This is, in many respects, a singular production; and, if any copy of it shall be preserved, it will give future generations a very extraordinary notion of the state of literature at the present time. If, indeed, we could imagine that every other impress of the mind of England, at the commencement of the year 1832, were to be obliterated, and this Magazine to stand alone as our only literary memorial, why, what would our great-great-grandchildren think of us? Here is a Society, aggregated for the express purpose of "diffusing *useful knowledge*;" having a central committee of some threescore names; the head of it the first temporal peer in the realm; a dozen more senators; many with literary and scientific additions; and the very humblest writing "*Armigero*." Furthermore, there are twoscore and upward of local branches, which share (upon the paper) the very "pick and wale" of provincial talent. Surely, if ever old Dulness and Ignorance are to be made to "rue the day," this is the wherewithal to vanquish them.

And what is the mighty engine in the hands of those giants of the earth? A Penny Magazine, published every Saturday, in sixteen small and sparse columns, which, in point of quantity, the humblest solitary scribbler who drudges in a garret could produce any day or every day in the week. Ay, but the quality? Well, the quality: it is *bis coctus*; nay, more nauseous still. It is like a "joint-stock quid," after it has run the gauntlet of twenty pairs of jaws in a back-wood wigwam; or an acorn, after passing through the same tale of hogs in a Westphalian forest, in the course of nature. It is a mere *mélange* of patches; many of them published before, by the same Society, in what they call their "Library of Entertaining Knowledge;" and in other conglomerates, for which, again, they have been picked up or pirated. How often have the Society (for they are answerable to the insulted talent of the country for the conduct of their tools) paid hush-money to those from whom they have pilfered, rather than have the bubble blown up in a court of justice? Did they ever hear of Dr. G. or Mr. R.? They are worse than the "soul-curer and body-curer" in Shakspeare; they have "stolen the scraps," without having been at "the leash of languages."

A "full-moon" of their pennyworth lies before us; let us see for what it is that they go about to chouse the poor out of their pennies:—

No. 1. Charing Cross; Beer; Van Diemen's Land; the Zoological Gardens; Des Cartes; Harvey; sundry scraps (many of them forgotten, and none original); Poland. Take the concluding sentence of the last:—"In the summer the heat is very great, the forests obstructing the free circulation of air." That short sentence is a constellation of falsehoods: false as regards the forests of Poland; false as to the general effect of forests; and betrays equally utter ignorance of the facts of geography and of physics.

No. 2. Pompeii; Van Diemen's Land (hyænas and cats falsely said to be natives of it); Scraps of the "Entertaining;" twaddle about a labourer's house.

No. 3. Somerset House; Scraps from the Colonial Office, from an American Newspaper, from Locke, from a dead compilation by the publisher, and from others; but none of any use, or affording any amusement.

No. 4. Sugar (the Entertaining); Population (Parliamentary Papers); Deaf and Dumb (their other journal); Rooks (the Entertaining); the Week (anybody); Walks, and the Essayists (nobody).

No. 5. Tea (the Entertaining); American Almanac; a Burgess; Poverty; Price of Corn; an Australian Scribbler.

Supplement. London Bridge; Travels in Africa; Scrap from Captain Hall; Transit of Mercury; Home Colonies, by Rowland Hill, esquire and schoolmaster, a committee-man. On the last of these there are some observations, which are really amusing; but we fear they will be lost upon the penny readers. In substance they are these:—There are, say, 100 labourers in a parish, all well employed and well paid; but admit *one* new-comer, and the whole are ruined. It comes thus:—The new man underbids one of the old, and turns him out; he turns out the second; the second the third; and so on, till Hob 99 works for the same wages as the new man, and Hob 100 is out of work. He comes as a new man, and the whole are again reduced; and so on, *ad infinitum*.

That piece of ratiocination must be their own; for, silly as some of the books of "single men" are, there are none that can come up to that: still it contains the essence of all their feeling and all their philosophy. They never suppose that there can be any affection between master and man, or between one labourer and another; and, by the theory, there is no invention. Necessity, the once all-prolific dame, is barren; and every additional man is additional misery. Need we wonder that there is neither information nor amusement in what emanates from such a quarter?

Why should it go down to posterity that the Lord Chancellor of England, and fifty-nine mighty men, and forty societies, had to leave their public duties in order that eight senseless and heartless pages should be published every week; and to save every man from perishing for "lack of knowledge,"—knowledge that the mightiest mountain of promise has brought forth the smallest mouse of performance? If our monuments are to shame Grub Street, in mercy to the great ones of the nation let us have the shame of making them upon our own heads!

Is it possible that all or any of the men whose names stand surety, in drab, upon the cover of the "sixpenn'orth," had any part or lot in the matter? Heaven forefend! If our judges, our senators, our D.D.'s, our F.R.S.'s, nay, even our esquires, were to be guilty of any thing so ludicrously absurd as that which we have analysed, why

"The girdling flood had changed to a strait jacket,
And all the isle gone mad."

In justice, or in mercy, to the committee of sixty, and the twoscore of provincial branches, we must acquit them of the actual sin of this piece of paste-and-scissors work. Then, how came their names on the cover?

Why is it "The Penny Magazine of the Society for the Diffusion of Useful Knowledge?" What "enemy" has "sowed tares" while those zealots in the cause of instruction slumbered? If we acquit, as we must acquit, their understandings, we must fasten the charge upon their "easy virtue." Why will they, by the sanction of their names, give currency to the most vapid trash that ever stained paper? It is dull, but it is borrowed dulness: it is cold, bloodless, and heartless; but it is cold, bloodless, and heartless at second hand; the merest scraps, by the most ignorant compilers, put together in the most tasteless manner, and impudently and cruelly fired at the poor from a sixty-pounder of mere names. The books were bad enough: the "Useful," without use; the "Entertaining," without entertainment: the first not adding one idea to the mere lesson of the schoolboy; and the second, as cold and heartless as the "Penny Magazine," and having an error in every page.

How could it be otherwise? What writer, even of a third rate, — of any rate at all, — could stoop to such brazen quackery? Those who have talents have feeling; and what man with the least spark of that could aid in butchering, in *cold* blood, the intellect of all the humbler classes in England. When the fetters of ordinary tyranny are on the limbs, the mind is free, and it "bides its time," and the fetters are burst asunder; but here is a mental bondage, under the prostituted name of "the diffusion of knowledge," and rendered available by a muster of names which no ordinary man could resist. Had there been talent in the case, such a monopoly would have been cruel: there being none, it is most monstrous.

If they have any writers of name among them, why are they not heard of? Is not fame — honest fame, won from the public, — the fuel that feeds the lamp of genius? Why then put the extinguisher of those names upon it? But they have it not? — The books — those dumb witnesses — cannot lie. Sir Richard Phillips never ushered worse compilations into the world, under the names of the doctors that he had dubbed, even when he had the score of drudges locked in the garret at seven shillings and sixpence a week. The notion of the juggle, for it is a juggle, was purloined from Sir Richard; the *modus operandi* is his too; but they want even his tact. They should have taken him as their director-general; and then, though the books would not have been good, they would have been much — very much — better than they are.

The Society for the Diffusion of Useful and Entertaining Knowledge, — where and when does it meet, and who attends it? Does Lord Brougham attend? Does Lord Althorp? Does Lord Ashley? Does Lord Dover? Not one of them. There are names on the covers of certain tracts, and there is a brass plate on a door in Lincoln's Inn Fields, and these are — THE SOCIETY! Yet by these are the public deluded, and the poor cheated out of their pennies; and for what? — for setting forth as the fountains of knowledge and amusement those who, in their own persons, had formerly, for bad verse and worse prose, been

"Banish'd from the footstools of the gods."

A Single Gentleman.

Such are the opinions of our reviewer, in many of which, any more than in his language, we do not concur. Nevertheless, the article having come to us through the hands of a highly esteemed friend, we have given it publicity. Our readers will judge for themselves. When the Society for the Diffusion of Useful Knowledge was first instituted, we hoped much from it, thinking that its object was to spread amongst the people the most useful knowledge; viz. that by which the working classes could soonest better their condition. It soon appeared, however, that the Society was

nothing more than a publishing monopoly, doing more effectually what had been before begun by Constable and by Phillips; that is, lessening the price of all books. We differ from our reviewer respecting the *Library of Entertaining Knowledge*, which we think has done much good, and more especially the natural history volumes. Our objection to the *Penny Magazine* is, that it seems studiously to avoid the subject of bettering the moral and political condition of the people, contenting itself with simply amusing them. Were the good of the people the main object of the *Penny Magazine* there is a very clear and straight-forward road for effecting it; but, if this road were once to be taken, the work would no longer be patronised by the Useful Knowledge Society. A penny magazine of knowledge, really suited to the people of this country, remains to be produced. In short, in this, as in all things else, those who want help must help themselves; and a magazine, for the good of the people, must emanate from the people. — *Cond.*

London, J. C., F.L.S. &c., with the assistance of J. Robertson, J. Perry, R. Varden, S. Thomson, J. Rowe, and other Architects: An Encyclopædia of Cottage, Farm, and Villa Architecture, &c. Part I., containing twelve lithographic plates, and upwards of 100 engravings on wood. 8vo. London, 1832. Price 10s. To be completed in 8 additional Parts, at 5s. each, so as to form one 8vo volume, similar in page and type to the Encyclopædias of Gardening and Agriculture. Price 2l. 10s.

We insert the title of this work in our Catalogue, more for the sake of recording the period of its appearance, than for either entering into the details of its contents, or recommending it to our readers. Having said thus much, were this Encyclopædia entirely our own production, we should stop; when, however, it is considered that we are only one among several who are engaged in it, we may be perhaps permitted to add, that, to the general reader, and to the lover of landscape scenery, it will be found by far the most interesting work of the kind that has ever been published; at least we and our coadjutors are ambitious to render it so. We have perfect confidence in the beauty of the designs furnished by them, and we hope not to be behind in the literary department. One great object that we have in view is, to instruct ladies in the study of architecture, and especially in the improvement of cottages; well knowing what they have effected for floriculture and landscape gardening, as noticed in our introduction to the work before us. They will find, from this work, that the study of architecture, as an art of design and taste, is as suitable to them as the study of floriculture or landscape-gardening; and, being of a more definite nature than the latter, is much easier.

To our American and Australian friends we hope to furnish a most valuable book; and to all country architects, surveyors, builders, and land stewards, one which they will find as indispensable to them as the *Encyclopædia of Gardening* and the *Gardener's Magazine* are to the gardener who wishes to keep pace with the progress of improvement in his art.

Such are the objects of our ambition: it is for the readers of the work to say how far we have succeeded in Part I., and to send us their criticisms, hints, and assistance in every form, with a view to Part II., and the succeeding Parts.

Kay, Jas. Phillips, M.D., Manchester: The Moral and Physical Condition of the Working Classes employed in the Cotton Manufacture in Manchester. 8vo, pp. 74. London, Ridgway, 1832.

This is a most interesting pamphlet; and it has been duly appreciated by the most philosophical of newspaper editors, and, in truth, the master-spirit of the daily press, as far as fundamental principles are concerned, — the editor of the *Morning Chronicle*. We notice the work, to recommend it to those who have leisure to attend to such subjects; and because it has

delighted us to learn, from its perusal, that the evils now suffering by the manufacturing population of Manchester are not necessarily inherent in the manufacturing system adopted there, but are to be traced to the influx of population from Ireland, and to other causes, all of which admit of remedy. The whole of these may be included under injudicious legislation, restricted commerce, and general ignorance. We are satisfied, with the enlightened and benevolent author, that the evils he has "unreservedly exposed, so far from being the necessary consequences of the manufacturing system, have a remote or accidental origin, and might, by judicious management, be entirely removed."

ART. V. *Literary Notices.*

An Introduction to Botany, by Professor Lindley, is in a forward state of preparation, and will shortly be presented to the public.

An Introduction to the Knowledge of British Birds, for Young Persons, by R. A. Slaney, Esq. M.P., is in the press, and will soon be published.

ART. VI. *Floricultural and Botanical Notices of new Plants, and of old Plants of Interest, supplementary to the latest Editions of the "Encyclopædia of Plants," and of the "Hortus Británnicus."*

Curtis's Botanical Magazine; each monthly Number containing eight plates 3s. 6d. coloured, 3s. plain. Edited by Dr. Hooker, King's Professor of Botany in the University of Glasgow.

Edwards's Botanical Register; each monthly Number containing eight plates; 4s. coloured. Edited by John Lindley, Esq. F.R.S., Professor of Botany in the London University.

Sweet's British Flower-Garden; each monthly Number containing four plates; 3s. coloured, 2s. 3d. plain. Edited by Robert Sweet, F.L.S., author of several botanical works.

Loddiges's Botanical Cabinet; each monthly Number containing ten plates; 5s. coloured, 2s. 6d. partly coloured. Edited by Messrs. Loddiges.

Maund's Botanic Garden; each monthly Number containing one plate, bearing pictures of four plants; 1s. 6d. coloured and large paper, 1s. small paper. Edited by Benjamin Maund, Esq.

The reader will find the few abbreviations used in the following extracts explained in p. 12.

DICOTYLEDONOUS PLANTS.

III. *Ranunculàceæ*. *Helléborus purpuráscens* W. & K. is figured in the *British Flower-Garden* for May, t. 142. It much resembles *H. víridis* L., but has a degree of pubescence on its radical leaves, which are palmately divided; its sepals (calyx leaves) are roundish, and tinged with lurid red on their exterior surface, and along the inner margin of their tips. *H. víridis* has its radical leaves perfectly smooth, and pedately divided; its sepals roundish, ovate, and perfectly green. *H. purpuráscens* very probably exists in some gardens, confounded with *H. víridis*. Mr. Sweet's figure and these remarks may lead to their being distinguished. *H. víridis*, as usually seen in gardens, scarcely attains to more than half the stature which descriptions in books ascribe to it in its native chalk woods; and this defection may result from omitting to accommodate the plant with the soil and shade congenial to its native habits. Mr. Sweet is of opinion that the best situation for *H. purpuráscens* will be "a warm sheltered wood, where the dead leaves with which it might be covered in winter

would protect it from the cold, and cause it to grow luxuriantly in spring, and to produce larger and better-coloured flowers."

XXIV. *Malvæcæ*. § Calyx double.

2011. *HIBISCUS*.
17926a *Genèveii* Boj.

Genève's  spl 15 jn.jl Ro Mauritius ... C 1.p Bot. mag. 3144

Of this superb *Hibiscus* the corolla is spreading, and 5 in. in diameter; the petals are of a white or pale rose colour, but are of a deep rosy lilac hue at their base; and this latter colour forms a conspicuous and admirable eye to each blossom. Dr. Hooker remarks:—"If this shrub be not already in our collections, as I suspect it is, through the influence of Mr. Telfair and the late Mr. Barclay, cultivators should haste to procure so great an ornament to the stove." The specific name compliments M. Genève, a zealous cultivator, who conducted Professor Bojer, who first named and described this species, to many trees of this *Hibiscus* in the forests contiguous to the Rivière Noire (Black river) in the Mauritius. (*Bot. Mag.*, April.)

Malvæcæ. § Calyx single.

2023. *SIDA*.

18069a *rosea* Lk. & O.

rosy-flwd  or 5 o Ro Brazil 1820 C 1.p Bot. mag. 3150

"Petals rather large, showy, broadly ovate, nerved, reddish, somewhat inclining to purple, very concave and erect, so that, taken collectively, they almost form a globose corolla; stamens numerous; anthers yellow, very compact;" therefore contrasting pleasingly with the rosy red petals. The leaves are on long petioles, are cordate, acuminate, nerved and serrated. This species "is evidently allied to the *Sida globiflora* of *Bot. Mag.* t. 2821, and is equally remarkable for the globose flowers and inflated calyx." (*Bot. Mag.*, April.)

LVI. *Myrtæcæ*. *Mýrcia àcris* is figured in the *Bot. Mag.* for May, t. 3153, and there described to be a very elegant tree, of slow growth and considerable size, native of several of the West India islands, and called in Grenada *bois d'Inde*. The timber is very hard, red, and ponderous, capable of being polished and used for mill-cogs and other purposes, where much friction is required. The tree fills the woods with the fragrant smell of its leaves, nearly resembling that of cinnamon, but its bark has none of the warmth of that of cinnamon, though the berries much resemble cloves, both in form and flavour. The leaves of the young branches are from 3 to 4 in. long, of a very sweet aromatic smell, and, on account of their agreeable astringency, often used as sauce. The flowers are small, white, with a slightly reddish tinge; the berries round, as large as peas, having an aromatic smell and taste, which render them agreeable for culinary purposes: they contain seven or eight seeds. *Mýrcia àcris* is commonly called, in its places of growth, wild cinnamon, or wild clove tree; and it is said to be the bayberry of Hughes. The foliage is neat and pleasing.

LX. *Protæcæ*. *Hàkea lineàris* is figured in the *Bot. Reg.* for April, t. 1489. *H. lineàris*, "in this country, forms a very beautiful evergreen bush, remarkable for the glossiness and rich deep bright green of the leaves." The white flowers are slightly fragrant, and produced in great abundance in axillary corymbs, and usually in August.

LXV. *Thymelææ*. *Dâphne Cucûrum* is figured in the *Bot. Cab.* for April, t. 1800, where it is remarked:—"Admirers of these charming plants [the daphnes] may easily enjoy their sweetness for several months, by giving some of them a little gentle stove heat, from January in succession till the natural season; for they will bear forcing extremely well."

LXXVII. *Leguminosæ*. § 2. *Lôteæ*.

2068. *LO'TUS*.

arenarius Brot.

sand  or $\frac{1}{2}$ sp Y Teneriffe 1831. S s.1 Bot. reg. 1488

A showy-flowered annual species, presumed to be hardy. (*Bot. Reg.*, April.)

LXXVII. *Leguminosæ*. § 5. *Phaseolæ*.

1885. LUPINUS.

28469a *Marshallianus* Swt. Marshall's \star or 5 jl.o B Eng. hyb 1830? C s.l Sw. fl. gar. 2. s. 139

Raised by C. Marshall (gardener at Mrs. Langtey's, Southborough, Kingston, Surrey), from seeds of *L. lépidus*. From the suffrutescence, habits, and foliage, Mr. Sweet judges *L. tomentosus* to be its male parent. Mr. Marshall states thus of the hybrid:—"It continues in bloom till the sharp frost sets in, and it had thirty spikes in flower on it at one time, from 12 to 18 in. in length, although the plant which produced all these had been moved late in spring." Mr. Sweet remarks:—"This plant, when dormant, produces a knot at the end of each shoot and joint, and up the stem, clothed with leaves; and there can be no doubt that these would all soon make plants, if taken off, and planted in the ground; so that it will soon become plentiful." [*Lupinus polyphyllus*, last autumn, exhibited, in Dennis's Nursery, many of these leafy knots, on flower stems which had risen too late in the season to flower fully and freely.] "We have seen flowers of several other curious hybrids of this genus, sent to us at the same time as the present, and others in some other collections, particularly in that of Messrs. Allen and Rogers, nurserymen, King's Road, Chelsea, and also at Battersea; in their nursery at the latter place they are chiefly grown. Some of these are very beautiful, and might readily be taken for real species, if their origin were not properly determined."

XCVI. *Rhámneæ*.

3311. SOULA'NGIA.

5866a *rubra* Lindl. red-flwd \star \square or 3 d R C.G.H. 1827? C pl Bot. reg. 1498

Received, a few years since, from the Cape, by Messrs. Rollison of Tooting. It is a hardy green-house plant, extremely neat in its foliage, and rather pretty when its brick-red flowers, nestled in down, make their appearance. Very near *Soulángia* [*Phýlica* that was] *thymifolia*, from which it differs chiefly in its branches being more downy, and its flowers much larger and more woolly. (*Bot. Reg.*, May.)

CXXXVI. *Sarraceniææ*.

1555. SARRACE'NIA.

minor *Nut.* smaller \yen Δ cu $\frac{1}{2}$ mr.my P.G. Carolina 1829. D. bog Sw. fl. gar. 2. s. 138.

A distinct and pleasing species of this peculiar and most interesting genus; "but it will be most likely a long time before it will be for sale in this country, except some person go to Carolina or Georgia [the native countries of the species] and send home a quantity of it." (*Flower-Garden*, April.)

CLVI. *Polygòneæ*.

1210. POLY'GONUM.

†10274 *adpressum* R Br. appressed-styled \star \square cu 60 my.au. W N.Holl. 1822. L 1.p Bot. mag. 3145

This plant has been found in Van Diemen's Land, as well as in New Holland; but, in the former country, at present only about Macquarie's Harbour, and is by the colonists called Macquarie's Harbour grape; but, although its axillary racemes of fruit at first sight resemble grapes, and although the stems of the plant ramble like those of a vine, and even to the extent of 60 ft. in a single season, the likeness does not hold farther. The seed of all the polygonums, which is a small hard nut, is known to be wholesome (as buckwheat); but in *P. adpressum*, the seed is invested with the enlarged and fleshy segments of the calyx, which gives to each fruit the appearance of a berry: some acidity in these fruits renders them available in tarts. About Macquarie's Harbour, the fruits of this plant are ripe in December and January. (*Bot. Mag.*, April.)

CLXIX. *Sapòteæ*. *Mimusops dissecta* Broun is figured in the *Bot. Mag.* for May, t. 3157. The peduncled white pink-tinted monopetalous corolla is cut into eighteen segments; these are arranged in a double series, and have suggested the specific name. Fruit, a large oval, or nearly ob-

ovate, by abortion one-seeded, at first green, at length brownish-purple, berry nearly of the figure and size of a muscle plum. The leaves are elliptical-ovate, about the size of those of the apple tree, penninerved, dark green above, and of a silvery grey beneath, and on petioles about an inch long. The cultivation of this plant, which is considered to be a small tree, is, as its fruit is esculent, too much neglected in our colonies. *A'chras dissécta* of Forster is presumed to be identical with *Mimòsops dissécta* of *Brown*; and from *A'chras dissécta* an unctuous fluid is said to exude: the fruit is of an agreeable acid, and, on account of it, the plant is extensively cultivated in China, Manilla, and Malabar. The leaves, pounded, and mixed with the roots of *Curcùma* (turmeric), and with ginger, are used as poultices for tumours. (*Bot. Mag.*, May.)

CLXX. *Ericcæ*. § *Vèræ*.

1173. ERICA.

‡ iii. undulàta *B. C.* waved-tubed  or 1? jn. Ro. C.G.H. 1827? C s.p Bot. cab. 1792

“ This was raised, a few years since, by Mr. Rollison : it grows low and bushy. The waving outline of the flower gives it the appearance rather of something blighted or imperfect ; but this seems constantly to prevail,” and the specific name undulàta is expressive of this waved formation. (*Bot. Cab.*, April.)

Ericcæ. § *Rhodorècæ*. — *The hybrid Azaleas at Highclere*. Of these we have made mention (Vol. VII. p. 62. 135. and 471.). Mr. Sweet, in his *British Flower-Garden* for April, t. 137., figures four of these, and includes them all under one specific epithet, namely, ornatum; and, as Mr. Sweet deems the genus *Azàlea* not botanically distinguishable from the genus *Rhododéndron*, they are called *Rhododéndron ornatum*. The main subject of the plate is *R. ornatum* 1 speciòsum; and to this are added a flower of *R. ornatum* 2 incarnatum, one of *R. ornatum* 3 lùteum, and one of *R. ornatum* 4 ròseum. Each kind is very handsome, and therefore desirable, especially the showy variety *R. ornatum speciòsum*. The corymbs of this are many-flowered, and the corollas are mainly of a deep orange red colour. The colour of the other varieties is indicated in the names applied to them. The specimens of all these kinds were sent to Mr. Sweet in the latter end of May, 1830. The following is the history of them, supplied by J. R. Gowen, Esq., to Mr. Sweet: — “ The seeds were raised by Lord Caernarvon’s gardener, from *Azàlea viscòsa* var. *rubescens*, fertilised by *A. póntica*, under Mr. Gowen’s own inspection. The gardener is very clever at raising these seedlings; but they have always been under Mr. Gowen’s observation till the present time. There are also many of the same age from *A. cocínea* by the same male parent [*A. póntica*]; and it is difficult to say which sport the most, and produce the most brilliant colours. I am inclined to think that *A. calendulàcea* would be a better plant to supply pollen than *A. póntica*, being a later flowerer, more disposed to sport, and more elegant in its habit; but its progeny would not possess that delightful fragrance which belongs to the crop from *A. póntica*, and which is very fine in some of the varieties which are now [latter end of May, 1830] flowering here.

“ I should observe, that when the foliage of the seedling follows closely that of the male parent, *A. póntica*, the flowers also approximate to the male type; on the other hand, when the foliage follows the female, so do the flowers. I think there is about an equal proportion preserved in the seedlings.” (*Flower-Garden*, April.)

CLXXI. *Epacrideæ*. *Lissánthe sávida* is figured in the *Bot. Mag.* for April, t. 3147. It has racemes of pendulous greenish white tubular corollas, which are succeeded by red globose drupes as large as a black currant, and which have something of the consistency and taste of the Siberian crab.

CLXXXVI. *Compòsitæ*. *Aster coridifolius*, *Coris*-leaved starwort, is figured in the *Bot. Reg.* for April, t. 1487; where Professor Lindley states,

that, until by comparison with an authentic specimen he had identified it with the *A. coridifolius* of Michaux, he had deemed it a distinct and undescribed species, and had called it *A. intricatus*; "under which name a few plants have been distributed from the Horticultural Society's garden, the only collection, as far as we are aware, in which it exists."

The stems of this perennial species attain the height of 3 ft.; and the pale flesh-coloured flowers, not larger than a sixpence, are produced in October. From America, and presumed to be from the vicinity of New York.

Aster cyaneus *Hoffman* is figured in the *Bot. Reg.* for May, t. 1495., and the following synonymes are referred to it:—*A. Nòvi Bèlgii* β *glauçus Ailon*, *glauçus* and *cyaneus* of *Nees*, *bupleuròides* of the Montpelier Garden, and *mutabilis* of the Berlin Garden. On this identification it is remarked, "There can be no doubt that these synonymies are certain ones: if we have not increased the list, it is because, although we can scarcely doubt that several more reputed species are also reducible hither, we have not at present the same absolute certainty in regard to them. In the gardens, this (*Aster cyaneus*) is sometimes called *A. phlogifolius*, *A. mutabilis*, and even *A. còncolor*; while Pursh has evidently confounded it with *A. Nòvæ A'ngliæ*, a totally different species." The above remarks are quoted in exemplification of the bewildering confusion in which the asters are involved, which will be information to those not already aware of the fact; while those who are, will rejoice to observe that they are receiving Professor Lindley's Ariadne-like attention.

CCXIV. *Acanthaceæ*.

61. ERANTHEMUM.

fecundum *Lindl.* ever-blowing \square or $\frac{1}{2}$ all sea Li Brazil 1829? C. p.1 *Bot. reg.* 1494

Few species of *Eranthemum* deserve the title of love-flower, which *Eranthemum* signifies, better than this. It possesses an unusual disposition to form flower-buds instead of leaf-buds. If its growth be checked by a dry atmosphere, repotting, or exposure to sudden cold, it is directly thrown so abundantly into flower, that young plants will often commit a sort of vegetable suicide, and kill themselves by their excessive fecundity. In the heat of the stove, and a good deal of atmospheric moisture, it increases readily by cuttings; and if encouraged to form leaf-buds by being maintained in a steady and uniform rate of growth, it forms a neat little bush; and the ends of all its branches are covered by short spikes of lilac-coloured blossoms, which are displayed almost all the year round. (*Bot. Reg.*, May.)

CCXXI. *Labiataæ*. *Scutellaria lupulina* *L.* is figured in the *Bot. Reg.* for May, t. 1493, as a variety of *S. alpina*; Mr. Bentham conceiving *S. lupulina* not specifically distinct from *S. alpina*. To the remarks on this point is appended an enumeration of all the species of *Scutellaria* hitherto known, and these are 58 in number: it will furnish useful clues to the student of scutellarias.

Melittis Melissophyllum *L.* is figured in Maund's *Botanic Garden* for May, t. 356., where these remarks, besides others, are expressed concerning it:—"The whole plant, in a fresh state, has not a peculiarly agreeable smell, as its odour approaches that of some species of *Anthemis*; in its dry state, however, it becomes pleasantly odoriferous, and this quality it is said to retain for many years."

MONOCOTYLEDONOUS PLANTS.

CCXLVII. *Asphodelææ*.

1053. ÆRNITHOGALUM.

bifolium *B.C.* two-leaved ∇ Δ cu $\frac{1}{2}$ au W Chile 1831. O s.1 *Bot. cab.* 1802

"The flowers are of a delicate white. We have kept it in a green-house, but it will probably bear the winter in a sheltered place out of doors." (*Bot. Cab.*, May, 1832.)

Scilla præcox W. is figured in the *Flower-Garden* for May, t. 141., from the rich collection of hardy bulbs possessed by A. H. Haworth, Esq., who received a bulb of the *Scilla præcox*, about four years ago, from the botanic garden at Bury St. Edmunds, under the name of *Scilla bifolia gigantea*; a name by which the plant has been sent out from that garden to the garden of the London Horticultural Society and to other places. It is every way larger than *Scilla bifolia cærulea* itself; and this is the readiest distinction between them. It probably exists in other gardens, confounded with *Scilla bifolia cærulea*, as it did in the Bury St. Edmunds one, until observed by the very discriminating eye of one of the supporters of that garden, the Rev. George Reading Leathes.

CCXLVII. *Asphodelææ*.

*1064a *CAMASSIA* Lindl. (*Quamash* or *Camass*, native name in N.W. America.) 6.1. *Asphodelææ*. 1—*esculenta* Lindl. esculent ♂ Δ or 1½jl D.P. Columbia 1827. O p Bot. reg. 1486

Professor Lindley quotes from Pursh as follows:—“This plant is called *quamash* by the native Indians; and the bulbs are carefully collected by them, and baked between hot stones, when they assume the appearance of baked pears, and are of an agreeable taste. They form a great part of their winter stores.” This fact it has been usual to attach to the *Scilla esculenta*, well figured in the *Botanical Magazine*, t. 1574.; but Professor Lindley remarks, that the *Camassia esculenta* “is the real *quamass* or *camass* root of the North-west American Indians, we know upon the authority of Mr. Douglas, who found it in the greatest profusion on alluvial, grassy, and partly overflowed soils on the Columbia, in 1825. Professor Lindley thus contrasts *Scilla esculenta* and *Camassia esculenta*:—“In *Scilla esculenta*, the leaves are glaucous; the flowers pale blue, and much smaller; the segments have a uniform direction and expansion; the stamens are shorter, and spread equally round the pistillum, which is straight. In *Camassia esculenta*, the leaves are bright green; the flowers deep purple; five of the segments have a direction upwards, while the sixth is bent down; the stamens are ascending, and the style is declinate. No doubt, therefore, can exist of their specific, or even of their generic, difference.” The flowers of this very beautiful plant are almost 2 in. in diameter, and were produced, for the first time in Britain, in July, 1831, in the Horticultural Society’s garden. Professor Lindley “scarcely remembers to have seen a more strikingly handsome bulbous plant: no art can do justice to the rich colour of the flower, which, although of the most intense purple, yet is so relieved by the satiny sparkling lustre of the cuticle, as to have quite a light and elegant effect. It has been hitherto cultivated in a peat border, under a north wall, where it grows freely, proving perfectly hardy; a few seeds were produced, and it is probable that when the bulbs are stronger [they are now about the size of a filbert], it will increase readily by seeds. Mr. Douglas also met with a white variety, or rather perhaps species, of which specimens are in his herbarium.” (*Bot. Reg.*, April.)

CCXXXVIII. *Amaryllidææ*.

3533. COBURGIA.
28152a *fálva Herb.* tawny-flwd ♂ Δ or 1 f. Taw S. Amer. 1829? O l.r.m. Bot. reg. 1497

A beautiful species, nearly allied to the splendid *C. incarnata* of Sweet’s *Flower-Garden*. The bulbs of this genus are hardy green-house plants; they may be kept dry in the winter, and planted out in the spring; but they will not endure the winter out of doors, except near the wall of a stove. They produce an abundance of offsets, which is probably the cause of their rarely flowering with us. Perhaps a strong and richly manured loam would promote their flowering.” (*Herbert in Bot. Reg.*, May.)

* *Spreckelia Heister formosissima Herbert*, *Amaryllis formosissima L.* “Heister first constituted this plant into a genus, and named it *Spreckelia*,

in honour of Baron M. de Sprekelsen, sometime secretary to the republic of Hamburg, and a great promoter of botany." Figured to exhibit two flowers on one scape, a sport of rare occurrence. Besides the present instance figured from Dennis's Nursery, Dillenius has recorded one, Mr. Herbert two, and Martyn's *Müller's Dictionary* alludes to others. (*Flower-Garden*, May.)

CCXXXIX. *Irídeæ*.

128. GLADIOLUS.

28893 1173a cochleatus *Swt.* spoon-tipped ∇ Δ or $1\frac{1}{2}$ mr W.R C.G.H. 1829. O s.p.1 Sw.f.gar.2.s.140

A species nearer *G. débilis* *Bot. Mag.*, 2585., than any others; the flowers of *G. cochleatus*, as well as of *G. débilis*, are of a snowy white, except the coloured marks on some of the segments of the perianth (petals in popular language). In these coloured marks, red predominates, and they give the flowers, which are not small, and produced two on a stem in the specimens figured, an eyed appearance. *Cochleatus* is expressive of a spoon-like form, exhibited by the lower segment of the perianth (petal); and *G. cochleatus* is published from the collection of H. B. Page, Botanic Garden, Southampton, who received the bulbs from the Cape of Good Hope more than two years ago. (*Flower-Garden*, April.)

CCXLIX. *Smiláceæ*.

2783. SMILAX.

§ i. § ii. sagittifolia *B. C.* arrow-ld \blacksquare \square or $1\frac{1}{2}$ aut. W. China 1820? D 1p *Bot. cab.* 1799

"The leaves are evergreen, of pleasing form and colour, and the plant is seldom more than a foot in height." (*Bot. Cab.*, April.)

CCXL. *Orchideæ*. § *Vándææ*.

2537. MAXILLARIA.

picta *Hook.* painted-flwd £ \boxtimes or $\frac{1}{2}$ d O spot. P Organ Mtns. 1830? D p.r.w *Bot. mag.* 3154

This is another of the many new orchideous plants received by Mrs. Arnold Harrison, from her brother in Brazil, where it was gathered in that spot, so fertile in vegetables of this family, the Organ Mountains. It eminently deserves a place in every collection, from the size and beauty of its blossoms. These are borne one on a scape, and the segments of the perianth (or petals) are all of them of a rich and deep orange colour within, spotted with purple; externally almost white, with spots and blotches of deep purple. (*Bot. Mag.*, May.)

2565. AERIDES.

cornutum *Rox.* horn-flwd £ \boxtimes fra 1 jl.au. F E. Indies 1820. D p.r.w. *Bot. reg.* 1485

Described as a most lovely plant, which, although recently imported by Dr. Wallich, had blossomed in the Kew collection as early as 1822. In its native localities it grows upon trees, and blossoms in June. In the Calcutta Botanic Garden, where it is cultivated successfully, it has gained the name of the Jamaica pomatum plant, from the resemblance of the rich fragrance of its flowers to that of the unguent so called. Professor Lindley thinks it rather comparable to the odour of the blossoms of the tuberose, *Poliánthes tuberosa*. The part of the flower which is horn-shaped is the labellum; this is three-lobed, with the margins of the central lobe, which is rather long, met together, so as to produce a conical spur, that is incurved, and green at its tip. The species "is certainly the most interesting of its tribe that has yet been introduced, whether we consider the great mass of its blossoms [these form a pendulous raceme 5 in. in length], their curious form, or delicate colour, or long duration, or delicious perfume. It flourishes in a very damp hot-house, planted in moss, in a pot suspended from the rafters; but, as it branches rather unwillingly, it is slow of propagation." (*Bot. Reg.*, April.)

Orchideæ. § *Epidéndreæ*.

2558a. PHAGUS.

22769 maculatus *B. C.* spotted-ld £ \boxtimes or 2 ja.jn Y Nepal 1823. D p.r.w *Eot. cab.* 1805
Blétia Woodtórdia *Hort. Brit.* No. 22760.

Published by Dr. Hooker, in the *Bot. Mag.*, as a native of Trinidad; but Professor Lindley states it to be from Nepal. Few orchideous plants are more attractive than this. The leaves are scattered over with golden spots; the flowers are eminently beautiful. (*Bot. Cab.*, May, 1832.)

2554. EPIDENDRUM.

variegatum Hook. var. *lvd. & fld* £ ☒ or 1 ja Ysh g.spot P Rio Jan. 1830. D p.r.w Bot.mag. 3151

Two or three leaves terminate each pseudo-bulb: these leaves are 8 to 10 in. long, strap-shaped, obtuse, striated, of a yellow green dashed with deeper spots; so that they have a variegated appearance. The raceme consists of eight or ten flowers. The perianth has six spreading, somewhat leathery, segments, of a yellowish green colour, yellower towards their tips which are obtuse, and their upper or inner side is sprinkled almost all over with blackish purple spots. Dr. Hooker says of *Epidendrum variegatum*, "It is extremely unlike any other species of the genus with which I am acquainted, and the flowers are very beautiful. The leaves, too, being spotted with a darker colour, have a remarkable appearance." (*Bot. Mag.*, May.)

Seasonable Hints on Floriculture. — By the first day of June the night frosts of spring may be fairly considered as past; and, consequently, immediately after this date, preparation may be made for transplanting into vacancies, in the compartments of the hardy flower-garden, whatever superfluous duplicates or multiplicates of ornamental plants the greenhouse or the hot-house may contain. As eligible plants for out-door summer decoration large plants of the fuchsias may be named, not forgetting the new species *Fuchsia bacillaris*, described p. 225., as soon as it can be obtained. *Salvia splendens*, *fulgens*, *involverata*, *Grahami*, and even *formosa*, are particularly splendid; and *S. fulgens*, planted in rich light soil, at the base of a warm-aspected wall, and trained over the face of that wall, forms, in autumn, an especially splendid object; the numerous spikes of scarlet flowers, produced at the extremity of its branches, having the effect of marking the plant's outline with a gorgeous wreath of scarlet. *Pelonia nyctaginiflora*, whose large white flowers are very fragrant by night, treated in the same way, is surprisingly improved, and rendered a very ornamental subject. (See Mr. Sweet's account of the result of this treatment in Vol. III. p. 297.) *Pelargoniums* may be copiously planted out; and the trailing-stemmed ivy-leaved kinds, trained over the surface of little beds set apart for them, and pegged into the soil at their joints, cover the earth with their glossy leaves charmingly, and flower beautifully and abundantly in autumn. *Marrándya Barclayana* and *M. semperflorens* are well known summer climbers of great elegance and beauty; and although there is a coarseness of aspect in that free-growing freely increasing novelty, *Lophospermum erubescens*, it is a climber whose copious wreaths of rosy blossoms excel in beauty and ornamental effect many other plants the habit of which is more delicate. (See a more detailed notice of it in Vol. VII. p. 201.) Besides these, numerous house plants, which it is superfluous to enumerate, may be made conducive to the floral decoration of the hardy garden; and while thinking of the beauty of the blossoms of plants, it will be well not to forget the beauties of foliage also. *Ficus elastica* is a beautiful object in its leaves during summer and autumn, when plunged over the rim of its pot in the soil of a sunny border; so also are the exquisitely leaved New Holland acacias, and numerous other plants. In the plants named above for the beauty of their blossoms *Bouvardia triphylla* should really have been mentioned, and our readers referred to the excellent article by Mr. Mearns in Vol. VII. p. 48., for a mode of cultivating this beautiful plant in the summer beds and borders most successfully, and also for a mode of so propagating it, as to have plants of it in abundance. — J. D.

MISCELLANEOUS INTELLIGENCE.

ART. I. *General Notices.*

HORTICULTURAL Syringes. — The admirable improvement made in this instrument, by Mr. Reid (*Encyc. of Gard.*, 2d edit., § 1419.), the origin of which, we have been informed, was the circumstance of a cannon ball having accidentally served the purpose of a valve in a ship's pump, has, as might be expected, led to subsequent improvements. One of these, by Mr. Macdougall, we have described in detail, Vol. VI. p. 305. : another,

59

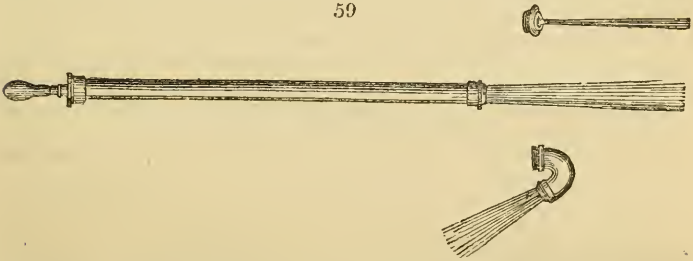

by Messrs. Warner, is figured and described in the *Register of Arts*, part xxxv. p. 14. The general form (*fig. 59.*) is the same as that of Mr. Macdougall's but, instead of the valve employed by the latter,

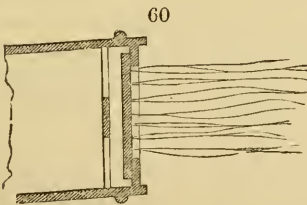

the rose head (*fig. 60.*) is in itself a valve, "which," says the editor of the *Register*, "renders the apparatus infinitely simpler, more durable, and not so likely to get out of order." The price by retail, we believe, is 27s. We have tried one of Warner's syringes against one of Macdougall's and one of Reid's, and we have conversed with those who have had some experience with them. The

result is, that both Reid's and Warner's are, from the nature of their construction, more liable to draw in such extraneous matters as may be in the water; and consequently the rose is more liable to become choked up in the action of syringing. Now, Macdougall's valve is guarded by a wire grating (Vol. VI. *fig. 58. c and g.*), expressly for the purpose of excluding impurities; we are therefore of opinion that it must necessarily be preferable, and we are certain that the workmanship is better at least than Warner's. A still more perfect syringe than any that has yet appeared has just been invented by Mr. Siebe, late of Holborn, but now of Denmark Street, Soho, whose rotatory garden engine and water cock we have before commended in this Magazine (Vol. VII. p. 84.); and whose rotatory pump, one of the very best of his inventions, we have described and figured in

our *Encyc. of Cottage Architecture* (p. 16., figs. 10. and 11.). Mr. Siebe's syringe, which he denominates

Siebe's Universal Garden Syringe (fig. 61.), consists of only one appa-

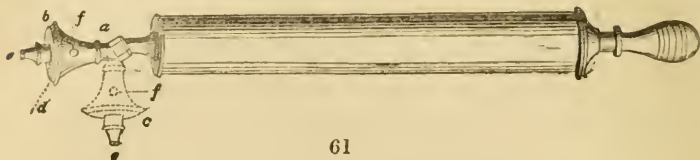

61

ratus, which can instantly, by turning a pin, be applied so as to serve the purpose of four different caps. The inverted syringe of Mr. Macdougall is imitated by a universal joint (at *a*), by which means the cap or head (*b*) may be turned in any direction, and to any angle (*c*). The pin by which the alterations in the rose head are effected works in a groove (*d*) in the face of the rose; and by it, a very fine shower, a coarse shower, or a single jet from one opening (*e*), may be effected at pleasure. The valve, by which the water is admitted to the syringe, is in the side of the rose (*f*). We have seen one of these syringes; and it is certainly an elegant instrument, most accurately fitted together; and, from a few minutes' trial, it appeared to work admirably. It will form an excellent instrument for the amateur gardener, male or female. The price is only two guineas, and the demand is so great that it can hardly be supplied. — *Contd.*

A detached Fumigator (fig. 62. *a*), which will fit any pair of common

62

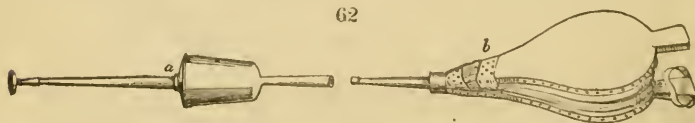

bellows (*b*), is manufactured by Messrs. Warner, and sold to the trade at a very moderate rate.

A portable Mangle has lately been invented by Mr. Saul of Lancaster, which, it is expected, will not cost more than 5*l.*; another portable mangle has lately been exhibited to the Society of Arts, at Edinburgh, the invention of Mr. Catleugh, a journeyman millwright, at Haddington. Both these machines are substantial, take up very little space, and are well suited to small families.

The Family Washing-Machine has recently undergone an important improvement, by the addition of rollers for the purpose of wringing. We have seen one of these machines at Weir's manufactory, Oxford Street; and we must say that it afforded us sincere pleasure, to see an obvious and easy medium by which the labour of women, in washing, may be very greatly reduced.

A Marine Railway, for the purpose of conveying vessels overland, has been projected by Henry Fairbairn, in the *United Service Journal* for May, 1832, p. 70. The vessels are to be raised from the sea by machinery, placed in slips, and dragged along the railway by locomotive steam-engines. The plan is contemplated not only with reference to Britain, but to every other country in Europe. The same author proposes, in this paper, and in one in the preceding number of the same journal, to connect Ireland with Scotland, by means of a bank between Portpatrick and Donaghadee; and England with France, by means of a chain bridge, causeway, or tunnel, from Dover to Calais. Over all the lines of marine railways he proposes to

form suspension railways, resting upon arches, in the manner of our friend Mr. Dick's (Vol. VI. p. 477.), for the conveyance of passengers, mails, and merchandise. We notice this scheme chiefly for the sake of exciting new ideas; and because it is always safer to introduce in our work what will tend to expand the mind, rather than to contract it. We perfectly agree with Mr. Fairbairn, that the world has yet obtained only a glimpse of the "revolutionary wonders" of the railway system, and that it will at no distant period effect important changes in every nation on the globe. — *Cond.*

Hybrid Poppies (Papàver nudicaule alpinum). — A strong plant of *Papàver alpinum* grew in the open border in the Edinburgh Botanic Garden last year. In the same spot this spring (1831), three very strong plants arose, with leaves precisely similar, though, perhaps, a little less finely divided. The flowers, on expansion, however, were found not white, as in *Papàver alpinum*, but deep and bright yellow, with a greenish tinge in the heart. For several years, many plants of *P. nudicaule* have blossomed freely in the open borders. The plant of *Papàver alpinum* had been impregnated by these, had died, and been succeeded by its hybrid progeny. The three plants are precisely similar; the flowers are as large as in *P. nudicaule*, and resemble that species in colour; the leaves, as I have said above, are almost exactly those of *P. alpinum*. A remarkable monstrosity appears this year among some of the plants of *Papàver nudicaule*. The flowers in some are semidouble; but in others, a few of the outer stamens only remain, the filaments in general assuming the form of fragments of a capsule, having hairs on their outer and ovules in their inner surface; the anthers are wanting, and their place is supplied by fragments of stigmata. (*Dr. Graham, in Edin. New Phil. Journ., June, 1831, p. 192.*)

Seedlings of *Papàver bracteatum* have been raised, from seeds produced in an English garden, whose petals had lost much of the usual crimson of *P. bracteatum*, and acquired nearly the scarlet of those of *P. orientale*. A large black spot occurs in the base of the petals of *P. bracteatum* and *P. orientale*; but, of the latter species, a variety exists in some gardens, the petals of which are spotless. This spotlessness is, however, possibly not constant. — *J. D.*

The Thistle of Scotland. — Sir, The late Rev. Mr. Lambert, the senior fellow of Trinity College, Cambridge, during a tour in Scotland, amused himself by endeavouring to ascertain what particular species of thistle was the prototype of the national emblem. He found the inhabitants not at all agreed on this point; and that the thistle of the seal of the Edinburgh Botanic Garden, that of the national insignia, and that of the Order of the Thistle, were apparently all different thistles; while such botanists as Mr. Lambert had opportunities of consulting on the subject could furnish no satisfactory historical clue respecting the species. The curiosity of Mr. Lambert hereupon began to subside, when it was once more excited by a bill from a silversmith, sent to his lodgings with some articles he had ordered, on the head of which bill a thistle, unlike the other thistles he had seen, was engraved as an ornament. On paying his bill, he remarked to the silversmith the dissimilarity of his thistle to those he had seen adopted in other places. The silversmith professed himself regardless of what others had adopted, maintaining that his (the *Cnicus acutis*) was the true Scottish thistle; and that it was proved to be so by the following narrative: — "At the time," said the silversmith, "that the Danes invaded Scotland, it was not the practice to commence an attack by night; but of this clandestine mode the Danes on one occasion resolved to avail themselves; and, to insure success, went barefoot. By this means they had approached unperceived near to the Scottish camp, when a Dane, having his naked feet pricked by a thistle which he trod upon, instinctively uttered

an ejaculation; and thus sounded an alarm to the Scottish soldiers, who instantly rose as one man, and slew the Danes with a great slaughter: and in commemoration of this signal service of *Chnicus acaculis*, it was adopted into our national insignia." The above account was communicated to me by W. C. Oldham, Esq., the nephew of Mr. Lambert. Soon after the king's visit to Scotland, some seeds were presented to the botanic garden at Bury St. Edmunds by a relation of the Bishop of London, who received them as seeds of the identical thistle, or kind of thistle, carried in the processions that attended on His Majesty in Scotland: these developed *Onopordum Acanthium*. I am, Sir, yours, &c. — *John Denson. Botanic Garden, Bury St. Edmunds, Nov. 1. 1829.*

When Potatoes are exposed in the time of Frost, the only precaution necessary is, to retain them in a perfectly dark place after the thaw. In America, where they are sometimes frozen as hard as stones, they rot if thawed in open day; but, if thawed in darkness, they do not rot, and lose very little of their natural flavour and properties. (*Hobart Town Courier, June 11. 1831.*)

Notable discovery! Dear brother-gardeners, henceforth toil not to collect and pit your potatoes for the winter; but, allowing them to remain in the rows where they have grown, treat them with a thin coat of mould, to keep out the light; heed not the frost, and dig out potatoes for use "fresh and fresh," as your wants require, and thaws permit.—*J. D.*

ART. II. Foreign Notices.

FRANCE.

THE vegetable Productions of the Neighbourhood of *Bagnolles Wells*, and of the whole of the Department of *l'Orne*, are numerous and excellent, including every kind of grain, and an immense proportion of sarrasin (buck wheat), flax, and hemp, all of which latter are cultivated with great care; and in the month of May, with a spring much forwarder than in England, were remarkably free from weeds. Considerable quantities of potatoes are planted; but, in point both of culture and productiveness, they are generally not equal to those grown in this country; their quality is also inferior, though the inhabitants have every requisite but knowledge and experience to produce potatoes in the highest perfection. The country abounds in all sorts of leguminous plants; and, in particular, with haricots (kidney-beans), and other excellent garden beans, which are brought to table dressed in a variety of ways, and are eaten both separately and as accompaniments to various meats. Most of these are subjects also of extensive field culture. The department is said to contain 643,528 hectares of land (more than 1,500,000 English acres), and 423,500 inhabitants. But notwithstanding their numbers (and the general disappointment expressed that the revolution of July had not been followed up with that reduction of taxation which it ought to have been), apart from a very few habitual beggars to be met with in some of the towns, there is no appearance of abject poverty any where. The country is fully enclosed; and small properties, in the hands of their owners, abound every where, and exhibit symptoms of comfort and independence, though they do not manifest such signs of improvement and prosperity as the major part of those observed in the department of *La Sarthe*. The neatly cultivated cottage gardens of the neighbourhoods of *Le Mans* and *Alençon* are wanting; but most of the poorest-looking houses have their patches of flax and their half dozen of apple and pear trees. There are neither tithes, taxes, nor poor rates to pay; and the style of living even amongst farmers of 150 or 200 acres being

simple and unexpensive, there is very little distress experienced by any one, and consequently very few crimes committed. The English style of gardening has made less progress in a district of country in many respects analogous to our own, than might perhaps have been expected, especially when its former connection with England, and the constant intercourse which then must have taken place, is considered. The raised terraces and straight walks, with other formalities now commonly discarded in England, are generally retained about the French châteaux. There is a forest residence of Marshal Grouchy, situated in the Ardennes Forest, in a more natural style; and M. de Conterne obligingly showed us walks in his magnificent woods; and over and along the beautiful stream running through them, which would do no discredit to the taste of an English landscape-gardener. Wherever it can be consistently indulged, this style seems to be greatly on the increase in different parts of France; and, besides various other instances in addition to those already mentioned in your Magazine, the garden of the Minimes at Tours, and the grounds of Les Ornes, on the banks of the river Vienne, the seat of M. d'Argenson, in Poitou, are favourable specimens. From Bagnolles to Domfront, and thence by Condé to Falaise, the country is highly interesting. This latter place, we were repeatedly told, with something more of complacency than we heard it, was the birthplace of William the Conqueror. Its immediate vicinity is picturesque and beautiful; and before reaching Domfront (as between Falaise and Caen), I found the most magnificent crops of wheat, growing in a woodcock-coloured loam, on a broken oolitic subsoil, that I ever remember to have seen. From Caen (one quarter, and some of the outskirts of which city are very handsome) all the way to Honfleur the country is delightful, with very little exception; it is every where enclosed, and though not highly is yet tolerably well cultivated. In the hedges by the roadside, acacias in great numbers exhibited their delicately white pendulous blossoms, and diffused their fragrance in great profusion. In the neighbourhood of Honfleur (which is situated nearly opposite to Havre at the mouth of the Seine, where it is seven or eight miles broad) there are many gardens in the English style, partaking largely of the superiority of the best English cultivation; but this district is chiefly famed for the production of melons, superior sorts of which are cultivated on a large scale in enclosures of the size of small fields, for the supply of Paris, to which city they are sent in vast quantities. Great part of the department of L'Orne, and the whole of Calvados, of which Caen is the chief place, are celebrated for their apples and pears; and, in favourable seasons, immense quantities of cider and perry are made, which, as in Herefordshire and Devonshire, constitute a great proportion of the drink of the country, besides supplying the neighbouring departments with the superior kinds. The vegetable productions of Calvados are similar to those of L'Orne, with the addition of turnips, mangold wurzel, &c., all of which might be cultivated to advantage in the latter department. Landed property is there also much divided; the country looks cheerful, and the people want nothing to enable them to develop, in common with the rest of France, the immense resources of their country, but the natural unsophisticated operation of the genuine principles of the Revolution, through the medium of a free and cheap government, in the extension of education, the total abolition of remaining monopolies, the unrestrained freedom of personal intercourse, and a really free press. — *John H. Moggridge. Woodfield, Dec. 1831.*

Destruction of the Apple Bug, and of Lichens on Fruit Trees, by Fire. — Sir, The Royal Society of Agriculture at Caen, in Normandy, proposed a prize for an essay on the best mode of destroying the "Puceron lanigère."*

* A new genus has been established, called *Myzoxylus*; from *myzo*, to suck, and *xylon*, wood.

The Society published the memoir sent in by M. Blot, and the following is an extract : — “ Pass rapidly, and repeatedly, over those parts of the apple trees attacked by the insects, wisps of burning rye straw. The trees suffer no injury, and the insects are instantly destroyed, before the epidermis of the tree is even heated. The insect is protected by a cottony down, of a very inflammable nature, and its body is covered by a kind of powder which is consumed by the fire the moment it touches it; the time for using this method is the end of autumn, winter, and, above all, spring. It is seldom necessary to repeat the operation, as the fire penetrates the galls, and destroys the eggs of the insect which are lodged within them.

Destroying Lichens by Fire. A custom prevails in Normandy, about Christmas time, for children to go about with torches of rye straw (provincially termed coulines), for the purpose of burning the lichens, mosses, and dead leaves on the apple trees. — *A Reader of the Gardener's Magazine at Caen.* March 3. 1832.

GERMANY.

Stuttgart, Feb. 16. 1832. — Sir, I have finished a plan for a new kitchen-garden here, and shall soon send you a copy of it. I received, some time since, three cases of pine-apple plants, and know only by the handwriting of the names in two of the cases, to whom I am indebted for the plants contained in those cases, not having received any letter, either with them or by post. The third case has the plants numbered, but not named; and as I neither found any letter in the case, nor have received one by post, I am at a loss to whom I ought to address a letter of thanks, to request, at the same time, a list of the names. Perhaps you will make known my gratitude to the givers of these plants through your Magazine, and add, that I should much wish to hear from the parties, either by letter or parcel, directed to the care of Mr. Nebringer, at Messrs. Charles Burket and Co., 147. Fenchurch Street, London. All my pine plants are looking remarkably well, and I hope to get, in the course of the summer, as large fruit as is generally grown in England. M. Salucci is very anxious to know when you intend publishing his designs for the palace of Rosenstein, and I am very curious to see your engraving of the park. There is a wonderful change for the better in this country since I left it. I am, Sir, yours, &c. — *W. Hertz.*

M. Salucci's plans are engraved, and proofs will be sent him shortly. — *Cond.*

Munich, March 1. — We have had a remarkably mild autumn, and, as usual, when that is the case, every thing is late. Our hot-water system of heating has succeeded perfectly, and there is some intention of applying it in our hospitals, and other public buildings; but the country is too much agitated for improvements of this description. The spring of our long-frozen country is about to commence, and we shall soon have the breaking up of the rivers, and a general débâcle. — *R. B. S.*

Preservation of Seeds. — At a meeting of the Horticultural Society of Berlin, a discussion took place respecting the proper method of preserving seeds. It was suggested that they should be enclosed in a vacuum. But all the practical men who were present objected, on the ground that it would tend to dry the seeds more quickly. They considered the influence, at least partial, of the air essential for the maintaining of the proper state of humidity necessary for the preservation of the seeds. M. Otto stated, in confirmation, that seeds sent to him in tin cases, hermetically sealed, never germinated, whilst those sent in boxes lightly covered with cloth generally arrived in a good state. Professor Link also stated that a vacuum quickly destroyed the germinative qualities of seeds. He mentioned an instance

of wheat having grown, after being kept 140 years, without having been excluded from the air.

I remember it being mentioned some years ago, by a gentleman who had been in North America, and present during the excavations made for a fortification, that he had observed that the soil thrown up from under a number of layers of limestone produced a variety of plants unknown in the neighbourhood: the inference is evident, that the seeds must have remained alive during the formation of the layers of limestone, and certainly excluded from the air. Dr. Darwin mentions an instance of mustard seed producing a crop, on soil being dug up where it had been at rest for ages. Seclusion from light and heat in the bowels of the earth appears to be the most certain method of preserving seeds. In such a state the temperature does not vary; and to the want of this uniformity we may perhaps attribute the failure of M. Otto, when using tin cases hermetically sealed. If the case containing the seeds were placed in a box lined with a layer of dry charcoal, or any non-conductor of heat, might we not thus artificially produce a uniformity of temperature? I am, Sir, yours, &c. — Charles M. Willich. London, Feb. 27. 1832.

The Prussian Horticultural Society. — At a Meeting held Feb. 5. 1832, among various other papers noticed, were the following: — A new method of removing moss from fruit trees, by paring the trunk as far as to the inner bark, successively employed by the Arch-priest Masselli of Breslau; and a note from the commercial gardener, Herr Gottlieb Friedrich Seidel of Dresden, in which he extols the sea-kale (*Crámbe marítima*), as forming an excellent fodder: in this opinion, however, the Society did not concur. Several printed papers were transmitted to the Association; among them were the *Proceedings of the Economical Society of Dresden* (26th delivery), from which the director read an extract, describing a method (completely successful on the first trials) of laying up fruit after the manner of potatoes, by placing them in heaps upon a layer of straw in a dry place, and overlaying them with a thick covering of straw and sandy earth; likewise by sinking new flower-pots, containing the fruit, several feet under ground, and covering them with straw and earth. The director also referred to an essay, equally worthy of attention, upon the storing of fruit in Pohl's *Intelligence concerning Domestic Affairs* (4th number). The second volume of Herr Freidherrn von Hammerstein's recent publications on agriculture, transmitted by the Agricultural Society at Felle, was the occasion of a discourse from Professor Link, private medical counsellor, who spoke with reference to that part which touches on the supposed origin of amber. Professor von Schlechtendal called the attention of the Meeting to the work announced by Professor Nees von Esenbeck, in Breslau, viz. *The Natural Groups of Asters, illustrated by Figures*, for which Grüson, the bookseller, of Breslau, receives subscriptions. The professor further communicated some interesting articles from Loudon's *Gardener's Magazine* (No. xxxii.). There were, besides, presented by Dr. Cranz, the landed proprietor of Brusensfelde, near Fiddichow, an interesting letter upon the labouring agriculturists in the province of Hither Pomerania and of the Island of Rugen; by the counsellor of justice, Herr Burchardt of Landsberg, a very scarce work, viz. *Les remontrances sur le défaut du labour et culture des plantes, et de la cognoissance d'icelles, contenant la manière d'affranchir et apprivoiser les arbres sauvages*, par Pierre Bellon du Mans (Paris, 1558, 8vo). This work, according to the statement of Herr Link, possesses a high degree of interest, not on account of its rareness alone, but because it gave occasion to the establishment of the first botanic garden. The chamberlain, Count von Hagen of Möckern, near Burg, gave information to the Meeting respecting the experiments made upon the cultivation of the seeds, sent from America to the Society, of a species of grass, very

much vaunted in that country under the name of crab-grass; but, from the dried specimens presented at the same time, it is conjectured to be no other than *Digitaria filifórmis*. — *G. R. March, 1832.*

NORTH AMERICA.

New York, Jan. 10. 1832. — It may give you some idea of the rarity of camellias, and the abundance of pine-apples, in this city, to inform you that the latter are now selling at 3*d.* and 4*d.* each, and the former at a dollar for an expanding bud. Almost the only nurserymen who have these flowers to cut for sale are the Messrs. Thorburns; and so great is the demand, that they have always a list of persons desirous of purchasing flowers, who are supplied, in the order in which their names stand on the list, as the buds successively expand. The flowers are worn by young ladies in their hair at parties. — *B. P.*

Extract from a Letter lately received from North America. — [The following extract is from the letter of a journeyman gardener, whose employer in the United States is a respectable nurseryman. We give it chiefly with a view of showing the extreme industry of the young man, and the kindness of his employer.] I arrived safe here on the 22d of September, having been a month and twenty-two days crossing the Atlantic, that is, from land to land. I have been very well received here, and have been well treated ever since. I live in the house, and sit at my employer's own table; I have access to a very good library; and, upon the whole, I anticipate a very good situation.

I study a part of every night at my English and French grammars; and Mrs. — has promised to teach me to draw and colour fruits. I take a lesson on the German flute every night from the junior Mr. —; and as I have already learned gymnastics, such as swimming, boxing, riding, and fencing, I entertain a strong hope of attaining all that you recommend in your *Encyclopædia* to be learned by gardeners. Mr. — has got your three *Encyclopædias*. The weather, ever since I came, has been delightful. These two months past we have had but three wet days, and these two or three last mornings a little hoar-frost: the thermometer ranged from 50° to 75° of Fahrenheit, out of doors, in the shade. I will not pretend to describe the richness of the scenery around this city, because I know you have fancied it all before this time; I shall only say that I am delighted wherever I turn. The taste for plants and gardening is spreading very rapidly in this country. Mr. — told me that he now sends more nursery stuff west of the Alleghany Mountains, than he formerly sold altogether. The market increases annually. Mr. Alexander Gordon lately called here, on his way to Florida and South Carolina: he looked in good health and spirits. He admired the apple trees in the nursery, and declared there were not any like them in North America.

A horticultural society exists in this city, I may say in embryo; but the members appear to be quite enthusiastic, and of course it will succeed. A new member will be admitted without paying the regular subscription, if he has written any thing for the advancement of gardening knowledge. I have been proposed, and balloted in already. — *W. Nov. 25, 1831.*

A Book on America has lately been produced by Mrs. Trollope. It is of the same character as Captain Hall's: but, as it relates chiefly to manners, we think it is calculated to do much more good than the former. Both writers will be found cleverly dissected in *Tait's Magazine* for May, 1832, and an admirable criticism on Mrs. Trollope will be found in an article entitled *Asmodens, &c.*, in the *New Monthly Magazine* for the same month. The Americans, in the case of Mrs. Trollope, will do as the Scotch did in the case of Dr. Johnson, after the publication of the doctor's tour in Scotland. They will profit from the remarks of their enemies. "They have

generous feelings, sound sense, and, above all, a rising literature — the only true softener and purifier of manners. The diffusion of high and equal knowledge, and a taste for art, should be the great and unremitted objects of the labours of the American patriots." (*Tail's Mag.*, vol. i. p. 234.)

ART. III. *Domestic Notices.*

ENGLAND.

PAIN'S HILL near Cobham, Surrey, that celebrated and most beautiful seat, which we have long admired both for its actual beauties and the associations connected with it, has lately been purchased by W. H. Cooper, Esq., of South Villa, Regent's Park; whom we understand to be a liberal and enlightened man, and, as well as his lady, warmly attached to botany and horticulture. We are informed that great alterations are making in the house, to which a conservatory is about to be added by Mr. Burton.

The Hot-houses at Bretton Hall, including the magnificent dome, figured in Vol. V. p. 681., and all the plants, with the museum, and many other articles, the property of the late munificent patroness of gardening and botany, Mrs. Beaumont; have lately been brought to the hammer, and sold for a mere trifle. The domical hot-house, which cost Mrs. Beaumont in all upwards of 14,000*l.*, brought only 560*l.*: it was bought on a speculation, and is now to be sold. The sale of these hot-houses, and other articles, we have been informed, has not taken place in consequence of any pecuniary difficulties, but, from a dislike on the part of Mr. Beaumont, the present possessor, to the general arrangement. In this respect, indeed, Bretton Hall was very unsatisfactory; and, though it contained a great many magnificent objects, it failed in producing, at least on us, and we have seen it frequently, one grand and harmonious impression. How different the effect of Wentworth House! The approach road to Bretton Hall is pitiable, and indeed there is not a single grand line of road or walk, as far as we could observe, about the demesne. — *Cond.*

Temple Newsham, near Leeds, is a pretty place; and Mr. Taylor, the gardener there, grows some of the finest pine-apples in England. He grew there last June a Providence pine which weighed upwards of 12 $\frac{3}{4}$ lbs. — *Peter Martin. Leeds, April 9. 1832.*

The Bayswater Botanic Garden, and its extensive collection of hot-house plants, so admirably managed by Mr. Campbell, are still unsold. We earnestly hope they will be purchased by some person who will keep up the establishment, which has long been considered as one of the finest private collections in the country, ranking with those of Bury Hill and Bretton Hall.

Seeds of the Palo de Vaco, the milk tree, have been sent home by Sir R. K. Porter, and distributed by his sister, Miss Jane Porter: one to Her Royal Highness the Duchess of Gloucester; one to Lord Powis; one to the Royal Gardens at Kew; one to Messrs. Loddiges; and the remaining one to ourselves. Some of these seeds we trust will vegetate. A tree of so much interest in its native country ought to be better known in England; and, through the patriotic zeal of Sir R. K. Porter, and his amiable family, we have no doubt that this desirable end will be accomplished. — *Cond.*

New Seedling Cactus. — A new seedling cactus, between *speciosa* and *speciosissima*, is now in flower in this garden. The plant consists of one shoot 2 ft. high, with three large flowers on the top, of a deep scarlet colour. — *Thomas Pressley. Plaistow Lodge, Bromley, Kent, April 26. 1832.*

A new Variety of Hawthorn with Carmine-crimson Blossoms.— This thorn, of which you have requested some account, was received here by the name of “new scarlet thorn” from Rivers’s Nursery, Sawbridgeworth, Herts; whence, as T. Rivers, jun., told me, it has been widely spread. It certainly deserves to be spread; for it is one of the most lovely of trees, and much more desirable than the old pink thorn, or, as it is often called, scarlet thorn. One of the plants of the new kind, received here from Rivers’s, is about 5 ft. high and bushy, and last year displayed several corymbs of blossoms. The flowers were from twelve to twenty in a corymb, and each individual flower of two thirds of the breadth of a sixpenny piece; the petals were of a most beautiful carmine-crimson, except in their claws, which were white, and thus constituted a white eye surrounded by a broad crimson orbit. It is a most charming variety, and richly merits an immediate place in every garden.—*Henry Turner. Botanic Garden, Bury St. Edmunds, Feb. 28. 1832.*

This account made us anxious to acquire so ornamental a shrub; and Mr. Rivers, jun., in a reply to our application, remarked:—“What a sweet mass could be formed by grouping this bright-hued variety with other varieties, which would supply together gradations of colour. From the carmine-crimson of the blossoms of the new variety, we could descend to the pink hue in the blossoms of the old pink thorn; from this to a pale flesh colour in the flowers of the double thorn, for these are of a pale flesh colour when fading; and from this to pure white in the blossoms of the common hawthorn, and those of the other species and varieties of *Cratægus*.”—*Cond.*

SCOTLAND.

A General Cemetery for Edinburgh is in contemplation, but the site is not yet determined upon: one party, it seems, proposing to place it in a low wet piece of ground, called the Meadows; and another in the King’s Park, that is, in part of the royal domain of Holyrood Palace. Mr. Neill “suggests one of the slopes at the south-western base of Arthur’s Seat, near the stile at Gibraltar House.” This place, he says, would afford great variety of surface, “capable of every sort of embellishment, architectural and arboreous.” We are glad to hear that the idea of ornamenting a cemetery is acceptable to the inhabitants of Edinburgh; and we hope, if such a burial-place should be formed there, a regular gardener will be appointed, so as to combine with it (as far as practicable), an arboretum and botanical garden. This seems to be Mr. Neill’s idea: we have thrown out one on the same subject, in the *Edinburgh Weekly Chronicle* for Jan. 21. 1832. Our plan embraces the whole centre or cone of Arthur’s Seat, with a view of combining a public park or promenade with a cemetery, and with various other objects, hinted at in the following extracts from the newspaper alluded to:—

“My plan does not include Salisbury Craigs, nor the east of the hill, but only the centre or cone, from its base at the park of Holyrood, on the one side, to the foot-path leading to the village of Duddingstone on the other. If this space were obtained, the main entrance might be made from the King’s Park, connecting it with the end of the Canongate by a broad road. From this main entrance let a carriage road be conducted up the hill, ascending it at not more than an inch in a yard (the slope of the road over the Simplon), and following all the irregularities of the surface, to which a rigid adherence to this slope might lead, till it reached the summit. Let the road then terminate in a level circular platform, with the naked rock, which, if I recollect right, forms the apex of the conical hill, rising up in its centre. From this circular platform let another carriage road, departing at a point of the circumference opposite to that at which the other entered, descend the hill, winding round it at the same

degree of slope as the ascending road, and, like it, following all the irregularities of the surface, to which an adherence to this degree of slope might lead, till it reached the gate of entrance at the King's Park. These two roads would, of course, cross each other at a number of places. Where they did so, let the one always cross the other over or under a bridge; not narrow architectural bridges, with parapet walls, like the viaducts of public roads, but simple rustic tunnels, like those which conduct (or did conduct thirty years ago) the eastern approach to Duddingstone House over the canal in the park. The length of the three arches of that viaduct is three or four times the width of the road, so as to admit of the latter being bordered by grass and trees, in such a way as to prevent the persons on the road from discovering that they are on a bridge. In laying out the roads, convenience and economy might lead sometimes to the ascending road passing under the descending one, and sometimes to a contrary arrangement. This, and a thousand details which will occur in practice, would be easily adjusted.

“ These two roads, being laid out, would probably give five miles of ascending, and five miles of descending road; which, judging from the road over the Simplon, might be trotted up and trotted down with ease. When the roads were newly made, the hill would have the appearance of being cut into winding terraces; but if the hill were properly sprinkled over with trees and shrubs, not to speak of tombs, monuments, and chapels, the effect, in a few years, would be totally different.

“ In arranging the ground on each side of the road, I should propose that the flat and comparatively inconspicuous places round the base of the hill should be thinly planted with trees, in the park style; and, as being nearest the town, this part might be devoted to the burial of those who did not choose, or who could not afford, to purchase their lair, or erect grave-stones. Happily, in Scotland these are but few. Then, on the rock which forms the summit might be erected, as a crowning ornament to the whole, an open circular temple, the basement story of which might be occupied by tea-rooms, reading-rooms, &c. The whole of the space between the base and the summit, not occupied by what I would call temporary public burial-places, might be sold to different parishes for the purpose of building churches or chapels, with burial-grounds attached to each; or to any of the different sects of religion in Edinburgh, for the same purpose. The space not occupied in this manner would, of course, be let out to individuals for private burial-places, and for the erection of tombs or other monuments to the memory of their friends, or of great men of the past or present age; and I do not see why the spaces not wanted for the purposes mentioned might not be let out for a number of years, for the formation of small fancy gardens, or even summer houses, or ornamental cottages. Among all these objects, trees, flowers, and plants would be introduced, according to the taste of the occupant; care being taken, by a superintending committee, that the roads were kept in perfect order, and nothing erected or planted that was glaringly absurd.

“ Such is the general outline of the style in which I would lay out Arthur's Seat as a public cemetery and park. Perhaps there would not be many parishes or sects who would choose to build their churches or chapels on it; but I cannot help thinking a number of both would do so in time; and the objection of distance would be readily got over by Sunday omnibuses, which, for a few halfpence, would convey those who could not walk to and from the hill. At all events, by sprinkling the whole hill over with trees, as soon as the roads were laid out, one of the most singular and interesting promenades in Europe would be formed.

“ It has long appeared to me (and I suggested the idea in the *Encyclo-*

pædia of Gardening ten years ago) that if every part of Arthur's Seat were rendered of easy access to carriages, by laying out roads in the manner which I have proposed above, it would be an admirable situation for villas and ornamental cottages. Perhaps one part of the hill might be devoted to this purpose, another to a zoological garden, and another to a general cemetery; but I confess I should prefer to see the whole a hill of churches, monuments, tombs, fancy gardens, and trees, with only a few intervening dwellings."

Mr. Neill, in a postscript to his pamphlet, says:—"Were Arthur's Seat as near to London as it is to Edinburgh, Mr. Loudon's plan would be good: but he seems to forget the difference between the two capitals. His scheme is too magnificent, and would prove too costly, for us: mine, I think, is moderate and practicable." This is no doubt true, if we limit our views to a cemetery; but if we extend them, so as to include churches, chapels, and other public buildings, and also private buildings, we should think the speculation likely to be a good one in a pecuniary point of view. — *Cond.*

Mr. Neill's Garden at Canonmills. — The rage for cleanliness and purification which lately existed in Edinburgh, in consequence of the cholera alarm, induced the magistrates to attempt to drain the loch or lake of Canonmills, on the margin of which the ancestors of Mr. Neill have enjoyed a small property ever since the close of the seventeenth century. This loch has become of more importance to Mr. Neill than it can have been to any of his ancestors, from the number of plants which he has in his garden. In a printed statement laid before the magistrates, he informs us that his garden, "though very limited in extent, contains a cool greenhouse, a warm greenhouse, and a stove or hot-house, with a double pit, and two large frames, all of them filled with flower-pots. The number of flower-pots requiring a supply of soft or river water daily [which can only be procured from the loch; all the other sources being impregnated with salts of lime, or of iron, and incapable of dissolving soap] is 2604." Mr. Neill farther observes, that "when the rarity and costliness of many of the plants are considered (the value of the collection amounting, according to the estimate of most competent judges [Messrs. M'Nab, senior and junior, of the Royal Botanic Garden], to £600 it must be admitted, it is to me a concern of no little interest and importance, laying altogether out of view the *pretium affectionis* [their keepsake value]; and the existence of my garden depends on my having access to the loch." We can sympathise with the feelings of Mr. Neill at the prospect of losing the soft water for his garden; and we heartily congratulate him and his friends about Edinburgh, and these include all who know him, on the success of his remonstrance, and the preservation of the loch. We have long wished for a plan and bird's-eye view of Mr. Neill's suburban retreat, which all who have seen it allow to be unique; but our countrymen at Edinburgh are difficult to move. — *Cond.*

IRELAND.

Dublin, Feb. 21. 1832. — Our weather here is unnaturally mild. The winter has been a perpetual spring. At this moment, on the north side of this city, in my garden and elsewhere, laurels are in flower. *Kérria japonica*, and many others, are also in most plentiful flower; and peaches, &c., will be in blossom, if the weather continues the same, in another week. Currants and gooseberries are expanding their leaves. Many green-house plants have stood out safely with me the whole winter. I shall, I hope, send you a list, ere long, of plants which have stood out more than one year with me, amongst which you will find many not hitherto attempted to be acclimatised in this country. — *R. Mallet.*

Rural Improvement. — Our correspondent, Mr. Murphy, we are glad to find, is making arrangements for being supplied with agricultural seeds; and, as he has had much experience in rural affairs, he proposes affording to “such gentlemen as honour his establishment with their orders, any information which they may require, and which it may be in his power to give, as to the best means of reclaiming lands; the prices, age, and kinds of trees suited to particular soils and situations; the kinds and proportions of grass seeds adapted to particular circumstances, &c.; subjects, for want of an acquaintance with which, he has reason to know that large sums are annually misapplied in this country [Ireland].” A man of Mr. Murphy’s science and experience might render immense service to the agricultural interest in Ireland, if there were enterprise enough among the country gentlemen to consult him, and take his advice. — *Cont.*

Improvement of the Labouring Class. — In the county of Clare, about ten miles from the city of Limerick, Mr. Vandeleur resides on his estate; and has employed on it between sixty and seventy people, all the year round, at the rate of eight-pence per day. About one third of this number are women (there are no children employed); but the greater part of the labourers are young and strong men, between 18 and 30. Some live in single cottages of long standing; the remainder are boarded and lodged, under Mr. Vandeleur’s inspection, in large but comfortable rooms newly built for the purpose, which admit of many economical arrangements of fuel, cookery, attendance, and arrangements, which obviate the necessity of the young labourer marrying merely that he may have some one to cook and bring him his meals. Mr. Vandeleur’s ultimate object is to give the peasantry an opportunity of elevating themselves to comfort and independence by their own exertions, and, if they please, obtaining a permanent interest in the land which they till. The working plan is this: — The labourers have well arranged committees of cultivation amongst themselves, who not only examine the localities, and determine what is best to be grown upon each, but assist in doing the work themselves. An exact account is kept of all the expenditure and produce. The labourers are credited to the full with all they can bring to the barn or the market, for Mr. Vandeleur’s use: and are debited with their wages for present support; with the rent of the land under cultivation, at an average of about 25*s.* per acre; with the county rates thereon; and, lastly, with the interest of Mr. Vandeleur’s stock and capital employed for their use. If they can produce a surplus on these necessary expenses, they are, by agreement, fully entitled to it, and may, if they think fit, become the purchasers of the land, at a fixed rate; or, having acquired stock of their own, they may remain on it as perpetual lessees. In its present early stage, this undertaking can only be considered as an experiment: it is, however, a most interesting one to the philanthropist; especially in the present state of the empire, when the oldest institutions are crumbling away before novel necessity and the growing spirit of reform in all things.

Another undertaking, on a smaller scale, but which promises to be equally instructive as an example, has occurred in the county of Cork, a few miles from the coast, at Tullig, near Skibbereen. Mr. Thompson of Cork has laid out a model cottage farm, of five acres, for the instruction of a numerous tenantry, strongly attached to old modes of cultivation and old habits of all kinds. He has stocked one acre as a garden, with fruit trees, roots, &c.; fenced, cultivated, and laid down the other four with the most improved rotation of cottager’s crops; built a cottage, with its addenda of cow-house, bee-house, pigsty, dairy, &c.; and placed a peasant of good character, and his little stock, on the little farm, with full powers to consume and enjoy all he can produce, but strictly bound to cultivate every perch of it by spade, and in the manner which Mr. Thompson has laid down as most exemplary. Failing in this, the tenant will fail also in his right of

possession, and must give way to one more docile; so that he has every inducement to persevere in orderly industry.

Near this is another building, which Mr. Thompson is fitting up for a school of industry for the children of his tenants, without any intention to interfere, directly or indirectly, with their notions on religious topics. Around it, Mr. Thompson has marked out five acres more, which the children are to be taught to cultivate with spades, as a field garden, on the most approved Flemish plan. The produce, great or small, is to be their own. The school does not open till spring, but the cottage-farm is fully stocked, and the tenant in possession. This Mr. William Thompson is the author of the *Inquiry into the Distribution of Wealth*. (*Times* of Feb. 22. 1832.)

By a Report of the Agricultural Cooperative Society in the county of Clare, in *The Crisis* (edited by Robert Owen, and advocating co-operation and the other opinions of his party, published in quarto weekly numbers, at a penny each), it appears that the above establishments are prospering. Every married man has a cottage to himself, and can either have his food cooked in the public kitchen, or dressed in his own house. The bachelors and spinsters sleep in separate dormitories. There is an infant school, in which every male youth is taught a trade, besides a thorough knowledge of agriculture. The children have a lecture three times a week, and two concerts, accompanied by dances. (*Crisis*, No. vii. p. 27.)

Ireland resembles the Continent, where every proprietor of a park or a garden, from the king to the humble country gentleman, enhances his own enjoyment by sharing it with the public. (*Tour of a German Prince*.)

ART. IV. *Hints for Improvements.*

THE following Trees and Plants would be well worth acquiring for Cultivation in Britain, viz.: — *Fagus betuloides* (the birch-like beech), an evergreen tree, 50 ft. high; *Fagus antarctica* (the Antarctic beech), a deciduous tree, 50 ft. in height; and the *Wintèra aromática* (Winter's bark tree): all found in the severe climate of the Strait of Magellan. [*Fagus betuloides* and *antarctica* were both introduced to Colvill's Nursery in 1830. *Wintèra aromática* (called now *Drimys Forstèri*) was introduced to Britain in 1827, but is as yet kept in the stove: it is an evergreen tree. — *J. D.*] At Zurich, apples of curious kinds are sold, some as white as snow. The inhabitants are particularly famed for the cultivation of flowers, and excel in China asters. At Lausanne, the red currants are of an extraordinary size. In Russia, a variety of rice is used, which grows in Siberia, and is more succulent than that of America. Enquiries should be made about this; because, possibly, in it our bog soils might gain the acquisition of a new production.

Tamarisk planted by cuttings in the spring, in driving sands on the sea-shore, will immediately take root; and the falling leaves, in a few years, will fix the sand. Sea-weed may also be collected and spread over the sand, which the stems of the tamarisk would hold in their place. Tamarisk may be cut every spring, and thus yield an annual profit: the wood is heavy, and good to burn.

Wild Cabbage. The Rev. W. T. Bree having called your attention to the wild cabbage of Dover, allow me to point out a use to which it may be most beneficially applied, viz., covering acres of sea-beach and driving sands. Plants should be put in in September or October; and in the spring, just as they were bursting into blossom, the crowns only should be cut to feed

cattle, and the stems left to seed, and possess themselves of the beach or sand. They would thus render these barren wastes most useful to the farmer; and fix the sands, which now drive, and cover all before them. Sand, this very sand, is the best of all possible manures for clay and heavy land; and, where it can be obtained, no other manure would be required during a man's life for such soils. If he could, in time, carry 500 loads per acre, it would work well at all seasons, and be the richest part of his farm. Pray call the attention of your readers to this fact.—*A. X. Feb. 8. 1832.*

ART. V. *Retrospective Criticism.*

CORRECTIONS to last Number.—In Dr. Hamilton's notice of the Pita de Guataca, p. 240. line 21., for "a small apple," read "a small pineapple."

Mr. Toward's Mode of having Volumes prepared for dried Specimens of Plants.—Sir, Your description of this mode occurs in Vol. IV. p. 436., and not p. 468., as you have wrongly indicated in Vol. VII. p. 155.—*A Porer.*

The Writings of Gardeners.—The following reason why the writings of gardeners "are not rendered so instructive as they might be, and as they ought to be, by those who pretend to teach," is given in the *Repertory of Patent Inventions* for May, p. 310.:—"There are professional arcana, which writers may never intend to reveal; and, in fact, it is scarcely reasonable to expect that they, who have a living to earn by their professional pursuits, should lay open to public view all the secrets of their art, particularly those more delicate minutiae upon which chiefly depends the success of an important operation. The blame, in reality, attaches to the insincerity of the pretence, not to the prudence of the writer."

Our contemporary was never farther from the truth than in the foregoing professional charge, which may justly be considered a libel on the whole race of modern gardeners. There is not a British horticultural writer, from Abercrombie (the author of *Every Man his own Gardener*, in 1766) to the present day, whose works do not contradict our contemporary's assertion. Gardeners may have described the processes of their art imperfectly, from not being in the habit of writing; but our contemporary must know very little, indeed, either about gardeners or their art, or he would never have allowed himself to indulge in the strain which we have quoted. He grounds his observation on a passage in the introduction to Cobbett's *English Gardener*, very well calculated to sell that book, because it promises to tell all that is known, and that has never been told before; but if any possessor of Cobbett's work will turn to *Mawe's Every Man his own Gardener*, even to any of the earlier editions, he will find all that Cobbett has done (and, as he would insinuate, for the first time) done better half a century ago. What Cobbett undertakes is merely to describe minutely the mechanical processes, which Abercrombie had done long before. Cobbett knows as little of vegetable physiology, or of the science of gardening, as the editor of the *Repertory of Patent Inventions* evidently does of the practice of gardening, or of its professors. If a further proof of this were required, the paper the editor has quoted to illustrate his observation would prove his ignorance of the subject, as, though very good in itself, it does not contain a single fact that was not previously well known, and that had not been as well told before.—*Cond.*

Correction of an Error in the Encyclopædia of Plants.—"Dicylra," instead of Diélytra. The same error also occurs several times in the body of the book. Dr. Hooker, in his *Botanical Magazine*, No. 3031., remarks:—"Diélytra is from *dis*, twice, and *elytron*, a cover; in allusion

to the two petals terminating in a bag or pouch. It is by mistake often spelled *Diclytra*." Your youthful correspondent. — *C. T. W. Derbyshire, January 11. 1832.*

We have already alluded to this correction, Vol. VII. p. 60., at bottom; but admit *C. T. W.*'s with thanks, because it is more in detail, and to evince our respect for our "youthful correspondent's" lucid correction. — *J. D.*

Sweet's British Flower-Garden. — Sir, In the reply of *F.* (p. 87.) to my observations on *Sweet's British Flower-Garden*, inserted in Vol. VII. p. 709., he appears to have wholly mistaken my object: it was certainly not with a view of attacking the gentleman who conducts that work with so much ability, that I animadverted upon it; but merely with the intention of recommending to your readers not to be too hasty in transferring to their flower-borders new and scarce plants, until they had first obtained duplicates. When the publication of the *British Flower-Garden* was first announced, it was proposed to figure only hardy plants, or such as would endure the winter in the open flower-borders: this was its professed object. Now, I will only ask *F.* candidly to state, if all, or even many, of the plants figured, are calculated for this purpose. That many of them are very beautiful, I am ready to admit; consequently, a great proportion of the readers of the work would probably be anxious to possess them; but if they were, on purchasing them, immediately to transfer them to their flower-borders, would they not be doomed to disappointment and loss? They must effectually keep the frost from some; others would perish, by being exposed to too much wet; and there are some that would never do any good in open borders, under any circumstances. If, therefore, artificial means are absolutely necessary to preserve them, is it not a misapplication to call them hardy? Would it be desirable to have the flower-garden (which you, Sir, very properly recommend to be, in every case, near the rooms most immediately in use) studded with pots, mats, litter, &c., for five or six months in the year? I have no objection, individually, to the plan of the work being changed; but I do protest against tender plants being figured in a work professing to give only hardy flowers and shrubs; and at the same time recommending them as calculated for open flower-borders. It is certainly very proper to attempt to acclimatise as many exotics as possible, and it is an object worthy the attention of every cultivator; because, in effecting it, you procure in many species far more beautiful and splendid flowers than you can do by growing them in pots. It is, therefore, not with any intention of deprecating these experiments that I have mooted the question, but solely with a view of recommending caution in the application. To the skilful and experienced, this advice is unnecessary; but to those who, like myself, only cultivate plants for amusement, it may be of some use. I need not take up your space in enumerating such plants as I consider not calculated for the flower-garden, because it must be obvious that my observations apply principally to the Cape bulbs, &c., and to such herbaceous and alpine plants as are liable to be killed by frost or wet; also to some of those that are so exceedingly diminutive, that they are little calculated for the borders, although very necessary in a collection as pot plants. Whether any of the above ought to have a place in a work such as the publication in question professes to be, I have great doubts; but I have none as to their unsuitness for the flower-garden. *E. London, February 18. 1832.*

The Agricultural and Horticultural Exhibition held at Stirling (p. 114.), and probable Origin of the Term "*Whinstone*." — These exhibitions, judging from first appearances, must, if persevered in, be attended with the most beneficial results to that part of the country, and reflect infinite credit on their promoters. You mention that the Irish whin was exhibited as an article of green food for cattle, and properly remark, that, owing to the difficulty of propagating it, it is not likely to answer the end. The common variety of *Ulex europæa* is that used for

feeding horses in this country. Every small farmer, in districts where whin abounds in the north of Ireland, has a stone trough, in which the tender shoots are beaten to a pulp, with a wooden mallet. This trough is generally formed of granite, and always of the hardest rock, whence, probably the term whinstone, as commonly applied to every very hard stone. I have seen the Irish whin very extensively employed in this manner, and only wonder that the use of it is not still more general. — *E. Murphy. Dublin, February 7. 1832.*

The Irish furze is cultivated in the nursery of Messrs. Whitley and Co., Fulham, and is named by Mr. George Don, in our *Hortus Británnicus*, p. 280., "*Ulex hibernica*." In some collections it is named *Ulex europæa* var. *stricta*; but Mr. J. T. Mackay considers it a distinct species, and no variety of either *Ulex europæa* or *nana*, and names it, in his *Catalogue of the Indigenous Plants of Ireland*, *Ulex stricta*. The principal, perhaps only, stations for it are the park and shrubberies of the Marquess of Londonderry, at Mount Stewart, county of Down; and of its origin there no one knows any thing. It has been stated to grow readily from cuttings, and to be a very valuable plant to the agriculturist. Mr. Stewart Murray states that it has been planted in dry hilly pastures in the north of Scotland, and that in the early spring it throws up a copious crop of succulent shoots, which are greedily eaten by sheep, when the supply of grass is insufficient. — *Cond.*

Mr. Howden's Answer to Mr. M. Murphy's and Mr. Haycroft's Criticisms on his Remarks on Irish Cottages and Irish Labourers. — We have received a long letter from Mr. Howden, in answer to Mr. M. Murphy (Vol. VII. p. 505.), and to Mr. Haycroft (Vol. VII. p. 710.); we cannot insert it in full, but the following are extracts: — Mr. Howden says, he is happy to hear that Mr. Haycroft is well, and that the wages of the men at Doneraile have been raised from 8d. to 10d. per day; he hopes that the women's and boys' wages have also been raised from 4d. to 5d.; "a mighty sum truly," says he, "when we consider that the Irish pennies go (like the baker's rolls) thirteen to the dozen. If these be the wages given by the first-rate noblemen, what can be expected from the farmers? The journeymen gardeners in my time, viz. 1813, I acknowledge (as Mr. Haycroft says), were 8d. per day; but what with sickness, and saints' days which were numerous, together with stoppages for back debts, the subsisting money for eighteen human beings was no more, and oftèn less, than 40s. per week. I remember one of my men stopping the whole of his wages for six whole weeks to pay 24s. for a hat. The poor fellow had some thoughts of going to England, and he thought the hat would make him look respectable. Every good thing in Ireland (except whisky) is dearer than in England. I tried to buy some Irish linen at a shop in Doneraile, and found that 3s. per yard was the lowest price; for, as the draper said, he dealt with the very first house in London for his Irish linen. This seemed rather like an Irish bull."

In another part of Mr. Howden's letter, he says, "With respect to Mr. M. Murphy's remark (Vol. VII. p. 505.) on my comparing my wife to a Venus, he must know that all lovers, and particularly poetical lovers, compare their mistresses to Venuses, &c.; and, after a fifteen years' trial, I am as fond of my wife as

" 'When I first show'd her the ring, and implored her to marry.' "

Mr. Howden adds, "that he never meant to say that the Irish peasantry were afraid of any thing: the man is no coward who dares to marry, and get a family of children, knowing that 5s. must feed and clothe them all for seven days." Still he believes "that children fed entirely on potatoes, and not half clothed, with quite naked feet, must give the features a different cast from that stamped on them by the hand of their Creator. The grass

land given to the poor in Ireland, for potatoes, is no favour at all, but quite the reverse: it saves the landlord, or farmer, the trouble of cleaning and manuring a naked summer fallow; yet this privilege is estimated at Done-raile as one fourth of a man's wages. The farm-labourers, in 1813, had no more than 6d. per day, and the gardeners 8d." — *J. H. Heath House, January 8. 1832.*

Collecting Slugs and Snails by Cabbage Leaves which have been heated and greased (p. 149.). — Sir, In clearer explanation of my plan, as described p. 149., I may say the cabbage leaves are not to be daubed all over with grease. I warm the leaves until they become quite soft, and I then rub a little bit of any sort of fresh grease between my hands, and this done rub the most of it off on a cloth, and then give each leaf a clap between my hands, but very softly indeed, and then lay them in the places where the snails occur. — *Peter Martin. Leeds, April 9. 1832.*

To put a stop to the Ravages which Caterpillars commit on Goosberry Bushes. — In this neighbourhood, several gardeners use the powder of black hellebore, wetting the bush first, then shaking on the powder through a dredging-box. I use, with great success, the flour of mustard seed in the same way, which is less expensive and less dangerous than the powder of hellebore. — *Id.*

Siebe's Cocks. — You have in Vol. VII. p. 84., been very laudatory of Siebe's cocks. He is not the inventor of them; as you may see by looking at the *Repertory of Arts* for 1800 (vol. ix. p. 37-89), where you will find Mr. Joseph Bramah's original specification of a patent for them; so that Mr. Siebe cannot possibly maintain his patent. My maternal grandfather and Bramah were fellow-apprentices, and warm friends while both were alive; and my father has frequently heard the former say, that, however well the cocks seemed in hypothesis, they never answered in practice. Now, you ought to publish this, because a monopoly for an old invention is intolerable. — *Robert Mallet. Dublin, Feb. 21. 1832.*

Filtering Machines. — There was much noise made some time ago, about a supposed new filtering machine, made by some one in Oxford Street (I forget the name). The water was to be forced through a stone disc, at one end of an iron cylinder, by a small pump, on the principle of the hydraulic press. Bramah was also the inventor of this; and the description of it is contained in the specification of the patent above alluded to. (*Repertory of Arts*, vol. ix. p. 378.) — *R. Mallet. Dublin, Feb. 21. 1832.*

Ammoniacal Gas. — I know that I am an inventor, but I perceive by your February Number (p. 41.) that I am not the first inventor, of the application of ammonia to the destruction of insects. — *Id.*

Leathern Wallet, &c. — As a reader of your Magazine, I must enter my protest against the decision of T. S. (p. 86.), that it is frivolous to introduce figures and descriptions of implements, &c., because, forsooth, they may be common in any given portion of the United Kingdom. I should be glad to be informed, whether, previously to the appearance of the figure (Vol. VII. p. 613.) to which T. S. objects, any thing so well adapted to the purpose was used, or even known, in this part of the world. — *E. Murphy. Dublin, Feb. 2. 1832.*

Cottan and Hallen's Iron Stakes for supporting Plants. — Sir, Your correspondent, E. S. (Vol. VII. p. 715.), objects to what he calls the poker-like shape of my iron stakes (Vol. VII. p. 284.); but I can assure him the sight of them would convince him the comparison will not hold. As he agrees in their economy, beauty, and safety, I would advise him to order a lot from Messrs. Cottan and Hallen, and I would almost engage to say he would be satisfied of their superiority. I have one now in sight, 6 ft. high when in the ground; a clean cast-iron rod tapering from an inch in diameter at the surface, to three eighths of an inch at top. The foot is 20 in. long, tapering down-

wards, $1\frac{1}{2}$ inch square at the shouldering, and slightly grooved. A plant with any weight of head, attached to a rod such as E. S. prefers, would be laid flat on the ground by a few hours' wind and rain: not that the rod itself would either bend or break; but unless the soil in which it is inserted were iron, as well as the rod, it could not, in such circumstances, maintain its position. I am, yours, &c. — *J. Hislop. Ashtcad Gardens, Feb. 6. 1832.*

Certain Gardens near Dublin.— Sir, I notice in the February Number of your Magazine (p. 83.), under the head "Corrections for the *Encyclopædia of Gardening*," what I cannot avoid considering a very invidious comparison, instituted by my respected fellow-citizen, Mr. Mallet, between the gardens of Frederick Bourne, Esq., and those of Counsellor West, both in the vicinity of this city; and as I, in common with all who have witnessed the expense Mr. Bourne has incurred, and the interest he takes in diffusing a taste for the more elegant branches of gardening, should be sorry to find the observations to which I allude perpetuated in a future edition of the *Encyclopædia*, I will, with your permission, endeavour to set you right upon the subject.

In the first place, then, I conceive that Mr. Mallet is not correct when he states, that, in the short notice of the garden at Terenure, which appears in the *Encyclopædia of Gardening*, you either emblazoned or exaggerated its deserts; on the contrary, I think it is evident that the information you were enabled to obtain regarding this, and other gardens on this side the Channel, did not afford you sufficient data for doing justice to them. When I inform you that 60,000 of the finest ranunculuses, almost an equal number of the choicest hyacinths, 1700 varieties of roses, many of them no where else to be seen in this country, together with a splendid collection of georginas, flower annually in the gardens of Terenure; and that these dazzling exhibitions are, with unexampled liberality, thrown open to every person of respectable appearance*; whilst Counsellor West's garden is not accessible even to gardeners and amateurs; you will easily decide which of these gardens merits the more flattering notice. Nor is it in floriculture only that the garden at Terenure excels every other in the vicinity of Dublin: the exotic department is highly respectable, and the collection of trees and shrubs can only be equalled in Ireland by that in the Botanic Garden, Trinity College.

Neither are you, Mr. Conductor, liable to censure for having omitted to notice Counsellor West's garden in the *Encyclopædia of Gardening*; as I doubt whether that garden was, at the time your work was published, (as Mr. Mallet would say,) *in rerum natura*: but be that as it may, that it is well deserving of notice at the present time I am most ready to admit, and we feel obliged to Mr. Mallet for his description of it. He must, however, pardon me for thinking his account would have been more valuable, if, instead of noticing vine borders 40 ft. wide, and "asparagus beds drained 5 ft. deep with boulder granite" (i. e. round granite stones found on the surface of the ground, the advantage of which, in preference to brick-bats, gardeners have yet to learn), he had favoured us with an account of the tropical fruits it contains, viz. guavas, mangoes, mangosteens, &c.; in the cultivation of which, I believe, Counsellor West has been very successful. — *E. Murphy. Dublin, Feb. 7. 1832.*

Choice of Situation.— Sir, I have been much gratified by perusing the "General Results" of your "Tour;" abounding, as they do, in every page with excellent philosophical and practical remarks. I was more particularly struck with what you say (Vol. VII. p. 644.) of building and planting in hilly countries, in preference to level ones, which reminded me of an

* 1400 persons, principally shopkeepers and artisans, have been known to visit these gardens in a single day last summer.

eloquent passage in your own favourite newspaper, the *Scotsman*, which I extract, thinking it well worth a place in your Magazine:—"I sometimes wonder how rich men, who can live where they please, after having once enjoyed the glories of mountain scenery, should choose to live in the interminable flats of Lincoln or Cambridgeshire. To dwell in a plain, without visible boundaries, affects me as if I were left at large in the world without a home; and to nestle in a wooded spot, where the eye cannot penetrate a mile in any direction, gives me a feeling of being imprisoned or smothered. This, I own, is a matter of taste; but the superior advantages which a mountain offers for exercise are great and palpable." (*Scotsman*, Aug. 1. 1829.) I am, Sir, yours, &c. — *John Robert Lawrence Aberdeen, Dec. 30. 1831.*

ART. VI. *Queries and Answers.*

A CERTAIN Irish Mansion (fig. 35. p. 91.). — The singular edifice of which a drawing is given in p. 91., stood at Ballyscullion, in the county of Londonderry, and was erected by Lord Bristol, then bishop of that diocese. A figure and description of both the interior and exterior, but which I do not consider of sufficient importance to occupy your pages, will be found in the Rev. Mr. Sampson's *Statistical Survey of the County of Londonderry*. The situation of this house was extremely ill-chosen, and notwithstanding the immense sum that was expended in erecting it, and that it was furnished in a style of Oriental splendour, Sir Harvey Bruce, to whom it was bequeathed, wisely abandoned it for a less imposing but more rational mansion. The portico of Ballyscullion House is now the portico of one of the churches in Belfast; and some splendid foreign marble columns and chimney-pieces, which were brought from it, may be seen in the Bishop of Meath's house at Portglenone. In this way the whole has been transported to one place or other, and not a vestige remains to mark the spot where, like the builders of the tower of Babel of old, the Bishop of Derry fondly imagined he was establishing for himself a name. "Sic transit gloria mundi!" — *E. Murphy. Dublin, Feb. 7. 1832.*

Sir, Lord Bristol's mansion, Ickworth, near Bury St. Edmunds, is upon the plan indicated in your engraving (p. 91.), though it does not agree with it in all its details. When I saw it in 1821, the body of the house only was erected; but the foundation of the wings indicated a plan as nearly as possible agreeing with that in the drawing. The history I then learned respecting it was this, that it was built in imitation of an Italian villa, after a plan sent over from Italy, by the late Lord Bristol, who was bishop of Derry, and who, residing almost entirely abroad, spent a great part of the revenues of the see in works of taste and fancy. I was told also that he had had two other mansions erected in Ireland, upon exactly the same plan; that Ickworth was the last of the three; and that he himself had never seen any of them. Ickworth was intended to be the principal of these three mansions; but a vessel, containing rich marble and other ornaments, purchased in Italy, and intended for it, having been taken by one of Napoleon's ships, the building itself was not proceeded in beyond the erection of the walls and roof, till the present Lord Bristol commenced fitting up some of the rooms a few years since. What progress has been made since the visit I paid it in 1821, I have not learned. — *S. R. B. Feb. 1832.*

Salt as a Destroyer of Weeds. — I should be glad to know if any of your readers has tried what quantity of salt will destroy all the perennial-rooted weeds, and how long it will be before the soil can be cropped with safety? Also, what vegetable or fruit will be most suitable for the first crop? I am, Sir, yours, &c. — *A Friend to Enquiry. March 26. 1832.*

A short criticism, which we have too long neglected, and although on another subject, bears sufficiently on the question just asked to merit insertion here. — *Cond.*

Salt as Manure. (Vol. II. p. 1.) — There are many conflicting opinions on the merits of salt as a manure, and whether it is a manure or not. Has there not been a want of discrimination in the different experiments? Are there not some plants and flowers, say hyacinths, tulips, and several other bulbous-rooted flowers, and many others, which thrive and grow more luxuriantly near the sea, with a soil and atmosphere impregnated with saline matter? It is said that Portsmouth and Portsea produce the finest broccoli: perhaps a judicious application of salt would, for these plants, be found beneficial, more particularly on chalky soils, and an inland situation. Does not experience show that it is improper to manure light land with light compost, and *vice versâ*? The farmers in the hundreds of Essex manure with chalk, to neutralise the saline qualities of the soil. If so, would not a proper application of salt on chalky lands be of essential benefit, and even on some other lands; and should it not be applied some length of time previous to the plants being planted, or the seeds sown? for I think it will be found evident, that salt applied after the foliage appears, will be prejudicial, if not destructive: I have used it, but never to any advantage. — *Charles Baron. Saffron Walden, Feb. 7. 1827.*

In relation to this subject, it merits notice here, that, at a meeting of the Cupar Horticultural Society, on the 25th of April last, a prize was given to Mr. William Smith, for leeks. These leeks, according to the *Fife Herald* of May 3., in which the show is reported, “were of an uncommon size; indeed, none of a similar size had before been shown at the meetings of this Society. Mr. Smith mentioned that the ground upon which the leeks were produced had been manured with common salt. The salt must be strewed upon the ground when the seed is sown; for, if applied after vegetation has commenced, it will destroy the plants.” — *J. D.*

Thinning and Pruning Plantations. — In Mr. Alexander Gordon’s interesting remarks on some gardens and country residences in Leicestershire (Vol. VII. p. 421.), mention is made, in high terms of commendation, of the system of thinning and pruning successfully adopted in the management of the plantations at Prestwold. Practical facts, such as these, are what are still much wanted, and your correspondent would confer obligation on many of your readers, by giving them, through the medium of your Magazine, full particulars of the “regular and systematic method of thinning and pruning, from the original planting to the full perfection of the timber, to which he alludes.” — *J. H. M. Woodfield, Dec. 1831.*

What is the best Work on laying out Villa and other small Residences, and its Price? — *W. Seymour. Palace Gardens, Bishopthorpe, March 26. 1832.*

Answer. — *Hints for laying out Town Gardens and Suburban Villas, from one Perch to a Hundred Acres in Extent.* London, 1811, 4to. The price, we believe, was originally 48s., but the work is now very scarce. We shall begin a series of designs for laying out gardens and pleasure-grounds, in our next Number. — *Cond.*

A Catechism of Gardening. — I wish you would draw up a small work, to teach the schoolmaster gardening; and also another elementary one, to put into the hands of the school children. — *J. S. M. Dumfries-shire, April 26. 1832.*

In Bavaria, there is Hazzi’s *Catechism of Agriculture and Horticulture*, which is taught in the public schools to the whole of the population. We do not see why there should not be, not only a similar catechism in this country, but one for every particular trade. This was attempted some years ago by Sir Richard Phillips; but his *Catechism of Agriculture* was ten times too dear. Works of this kind should be as cheap as religious

catechisms. Whenever any bookseller shall be found willing to undertake such publications, we shall be ready either to write them, or to get them written in the very best manner. — *Contd.*

Murray's Tallies (fig. 16. Vol. III. p. 29.).— I can get none of these tallies about London; and knowing no one about Glasgow, I apply to you for advice, &c. — *R. S. T. Exmouth, Feb. 20. 1832.*

These tallies may be had of Messrs. Cottam and Hallen, of Winsley Street, London, in quantities under a cwt., at 2s. 3d. per dozen, with the iron only; or 3s. per dozen with the iron and small pieces of deal for writing the name on, and of glass to fit. In quantities above a cwt. the price will not exceed 18s. per cwt. for the largest size, or 22s. for the smallest. We recommend purchasers of these tallies, or any others of the iron kind, to pay a trifle extra to the manufacturer for putting them when nearly red hot into train-oil or gas-liquor. We also recommend gardeners, when they send for only a dozen or two of small articles of this sort, to pay the postage of their letters. Of all the tallies which we have seen, Murray's are by far the cheapest and best for herbaceous plants in the open air. For large trees and shrubs, brick tallies (figs. 11. and 12., p. 33. of our present Volume) are preferable, on account of their durability, and the more fixed and permanent character of their appearance. — *Contd.*

Weights and Measures in Covent Garden Market. — Sir, It was observed, Vol. VII. p. 255., that the lists of prices in Covent Garden Market are deprived of half their utility to country readers from many of the terms being used only in London. I perfectly agree in this opinion; and hope that the objection may soon be removed, by having such terms as pinnets, sieves, &c., explained in such a manner as to be intelligible to your country readers. — *J. W. L. Birmingham, Sept., 1831.*

The indigenous Flowers and Fruits of the State of Ohio. — Mrs. Trollope, in her *Domestic Manners of the Americans*, vol. i. p. 87., says, speaking of Cincinnati: — “The flowers of these regions were as bad as the fruits. Whether this proceeds from want of cultivation, or peculiarity of soil, I know not; but, after leaving Cincinnati, I was told by a gentleman who appeared to understand the subject, that the state of Ohio had no indigenous flowers or fruits.” As Mrs. Trollope is considered to have given way to her prejudices on other subjects connected with America, and as I intend, notwithstanding all she has said to emigrate thither, as soon as I can raise money to pay for the passage of myself and a large family; I should much wish to know what truth there is in this information of “a gentleman, who appeared to understand the subject.” Perhaps some of your readers who have been in America, or some American correspondent, can solve my difficulty. I am the more anxious to have it solved, because, assuredly, if there be no indigenous flowers and fruits at Cincinnati, it is the very part of America that I would emigrate to in preference. It will be rather odd if I do not find some of the fruits and flowers of corresponding latitudes that will flourish there, whatever may be the “peculiarity of soil.” — *R. S. T. Holderness, April 15. 1832.*

The Tree Mignonette. — In Jesse's *Gleanings in Natural History*, just published, it is stated (p. 165.) that, “in trenching for a plantation in a part of Bushy Park which had probably been undisturbed by the spade or plough since, and perhaps long before, the reign of Charles I.; the ground was turned up in the winter, and in the following summer it was covered with a profusion of the tree mignonette, pansies, and the wild raspberry.” Now, Sir, on turning to your *Hortus Británnicus* (p. 190.), I find that *Reseda odorata* var. *frutescens* was not introduced till the year 1752, upwards of a century after Charles I. was beheaded. In the same page it is stated, that, so completely is the ground impregnated with seeds, if “earth is brought to the surface at the lowest depth to which it is found, some vegetable matter will spring from it.” This last is by far too indefinite an assertion to be made in a scientific work. Will the author

affirm that the London clay, for instance, at the depth of 100 or 200 ft., contains seeds, which, when the clay is exposed to the surface, will vegetate? As to the tree mignonette, I should really be glad to know what plant is meant by it. Surely Mr. Jesse cannot mean the British *Resèda lûtea* or *Lutèola*? Perhaps some of your readers in the neighbourhood of Bushy Park will be good enough to examine the spot, and to send you the result. — *A Lover of Accuracy. Hereford, April 14. 1832.*

Huish's Beehive. — Sir, In your *Encyclopædia of Gardening*, 2d edit., § 1743., you have given a description of Huish's beehive. I, having come to this part of India, was much delighted to find bees cultivated by the mountaineers; who, instead of hives, use the hollowed stem of a tree, and shut it up at each end with a bit of plank, closing the joints with lime mortar. The box thus made, is preserved from the heat of the sun by being placed under the eaves of the thatch of the cottages, which extend 2 ft. or 3 ft., and come down very low, to exclude the heavy rains that fall here for seven months; or is protected at a distance by a few mats. The honey is excellent. I have often tried to cultivate bees in the plains of Hindoostan; and, though I have repeatedly caught and hived swarms, I could never retain them. Once, indeed, I kept one for a fortnight, which began to make a comb. I believe the reason is, that the heat of the hive is too great, being frequently 120° to 130°, or perhaps more: the air is often 110° to the westward.

The object, however, of my now addressing you, is to enquire whether, in Huish's *Treatise on Bees*, there is not a misprint, which you have copied. He says: — "Having obtained eight pieces of well-seasoned wood, about 3 in. broad." Now, this would be 24 in. for the breadth of the hive, without any interstice for his net; whereas in his engraving [fig. 295. b, of *Encyc. of Gard.*] (I have his book), the interstice is three times the breadth of the piece of wood: perhaps it should be three quarters of an inch. Pray do me the favour to consider this; and, if you know Huish, enquire from him the height and breadth of his hive, and how his eight pieces of wood are placed. I am, Sir, yours, &c. — *W. Cracroft. Kossya Mountains, 4500 ft. high, Nov. 15. 1831.*

On application to Mr. Huish, he kindly sent us the following; which we hope will be satisfactory to our correspondent, — from whom we shall be happy to hear frequently. — *Cond.*

In reply to your Indian correspondent on the Kossya Mountains, requesting some information relative to the construction of my hive, I beg leave to inform him that he is perfectly right in supposing that the dimensions, as stated in the first edition of my *Treatise on Bees*, are incorrect; and I regret to state that the error has been the occasion of many persons being deterred from adopting the hive, on account of the difficulty attending its construction, arising solely from the inaptness of the dimensions as printed in the book. When the first edition of the work was printed, I may say that the hive was then in its infancy. The form was originally circular; but the disadvantages of that form soon presented themselves: the principal of which was, that the side combs, which are always the largest, and contain the finest honey, were reduced to a very small size, on account of the segment of the circle allowing the bees very little scope in which to form a comb. By the aid, however, of some skilful workmen at Datchet, I succeeded by degrees in bringing the hive to an almost perfect square; and as such it is now in use: and your Indian correspondent will find it to be his interest to adopt that shape, as nearly as the skill of the workman can accomplish it. Seven bars will be found quite sufficient; although it must be taken into consideration that I am here alluding to an English climate. The bars should be three quarters of an inch, or an inch, in breadth, and made of oak or elm: deal is in its nature too frangible, and too apt to warp. The distance of the bars from each other should be from 1½ in. to

2 in., particularly observing to give a greater space between the side bars than between those in the middle. The bars are fastened at each end to a projecting band of the hive by means of a wooden peg, or by nails known by the name of clouts: the latter are, however, apt to rust, which sometimes impedes the extraction of the comb. In regard to the height and breadth of the hive, they are entirely a matter of option; it is, however, a mistaken notion that the larger the hive the greater the produce of honey. Too much space is as injurious to the bees as too little; but, in adopting the medium, the apiarian must be guided by the climate in which he lives, and by the fertility of the district in which his apiary is situated. My hive is now generally made of about 16 rands of straw, and averages about 20 in. in height up to the projecting rand on which the bars rest. The breadth should be nearly equal to the height, observing particularly that the upper part of the hive be broader than the lower, in order to prevent the falling of the comb, as no sticks are ever to be used in one of my hives.

I believe I have now answered the different queries of your Indian correspondent; and I take the opportunity of informing you, that, in a very short time, I will transmit you an article *on the power of the common bee to generate a queen*; which fallacy has been lately industriously circulated by the Society for the Diffusion of Useful Knowledge, on the mere authority of Huber, whom I hesitate not to designate the Munchausen of apiarians. I am, Sir, yours, &c. — *Robert Huish. May 18. 1832.*

ART. VII. *Cottage Gardens, and Gardens to Workhouses, Prisons, Asylums, &c.*

I BELIEVE there is no nation that thinks more of its poor, or is more alive to charity, or more anxious to relieve the distresses of the wretched, than the people of this country. I think, however, that some of the best-intentioned philanthropists are deceived in their exertions to be of service to mankind. At this moment wealthy and liberal landlords are apportioning to cottagers an acre of land, more or less, hoping and believing it will afford the greatest benefits to the humbler classes. Your Magazine, and the public press generally, are caught with the good it will do; and I am therefore less confident in my opinion upon that subject than I otherwise might be: but, anxious, as a landlord, to do good to those around me, I would most willingly give my labourers and cottagers land, if by such a system I could persuade myself it would be for their benefit. Supposing a nobleman or gentleman had fifty day labourers, each having his acre of ground. As a gardener, I need not state to you at what season, or what time during that season, it would be requisite that the labourer should work upon it. I think I have read in your publications, and in other works, that an acre of garden ground is sufficient to occupy the entire of a man's time; but, for argument's sake, suppose I say that two months' labour would suffice. To do justice to his ground, the labourer would be engaged just at those moments his master would require his work on the farm to be going on; and it could hardly be supposed that a landlord could employ such a peasantry on his estates, taking only half days and quarter days of his men's coming to work; four days in this week, three in another, one in another, and so forth; the remainder of the man's time being required to manage his own acre.

This, in my mind, is the first objection to the plan; but there is another, which appears to me as powerful, that I wish an answer to. I am really seeking information, to follow the steps of others (if persuaded), anxious to ameliorate the condition of the poor in my own parish.

How would you recommend the cultivation of the said acre? Potatoes,

the best and most useful crop, you are aware, cannot be planted year after year on the same ground. Land should be laid down, and be in repose, at times, unless it is a garden well manured; and how is that to be supplied to the labourer? The ashes, the manure of the pigsty, and other *et cætera*, which the labourer could heap together, would be too trifling. Cabbages, onions, &c., are such things as the little garden, which every man should have about his cottage, would give him; though how seldom is it used for such purposes! In France the peasantry have commonly a pot on the fire, with a pound or more of meat in it, with cabbages, turnips, onions, and other herbs, making an excellent pottage for a numerous family. Such is not the mode of living of our peasantry, and more particularly in this part of Wales; for, from habit, they prefer butter-milk and potatoes, and butter and barley bread, to meat. I state to you, from my own knowledge, that butter is considered by the labourers here almost an essential; and that, when good meat was threepence a pound, few purchased it, paying rather a shilling a pound for butter. Whether there is a prejudice against, or a supposed degradation in the poor living upon, broth, I cannot say; but I have seen and eaten charitable soups, which the poor have scarcely been willing to take. I cannot but think, that, by giving a man labour the year round, his time or wages would be more valuable to him than the acre of land; but for poor-houses, lunatic asylums, and prisons to have lands attached to them, I am clearly of opinion would be a great benefit in many ways.

I have followed a system here, whether of profit or loss I do not stop to enquire, which is as follows, and which appears to me as good a method of giving a helping hand to my labourers and poor neighbours as any I have heard of being practised:—

My farm is about 230 acres, and every year I plough and prepare a large field for potato ground, inviting all to plant in it who choose. I bring their manure for them, leaving my bailiff to see fair play as to the quality and quantity they put in the rows, so that the land may be left sound and good for the wheat crop that is to follow. The peasant has but to plant the potatoes, hoe them, and keep them clean; and he is permitted to take off the entire crop without any payment whatsoever. By this arrangement he loses little or no time: the planting operation is soon performed; and when the ground is to be hoed the days are long, and the labourer can employ himself on it during after-hours, instead of going to the beer house or political shop, a rendezvous more inimical to the interests of the country and the wellbeing of the poor peasant's family, than any thing that has been adopted for the last half century.

I am not one of those who think well-intentioned people act wisely in extending education as it is now progressing. When labourers finish their master's work, I would have them, as in times of yore, go home to their wives and children; and should like to see them save their money, instead of spending it at political clubs, or card parties, or dominoes; or wasting their time in listening to, or reading, the publications that are laid before them, religious, or rather anti-religious, and political. I may be asked, Would you deny them luxuries and comforts, if they could afford them? No: I would let them have their beer at home; but chattering about protocols, discussing new constitutions, troubling their heads with the affairs of Europe, or reading the slander and calumnies too often heaped on the magnates of our land, I believe to have changed the nature of our peasantry, I regret to say, most materially. — *H. Wales, March 8. 1832.*

We have never recommended any definite quantity of land to be attached to cottages: we are clear that no cottage ought to be without a garden of more or less extent; and this is as far as we can say that our ideas are absolute. All the extent of ground attached to a cottage, beyond such a garden as can be cultivated during the leisure hours of the cottager,

must depend on how he can make use of the produce, and on a great variety of other circumstances. In general, let the cottager have a good cottage and garden, constant work, and sufficient wages, and the rest may be left to him and his employer. Our correspondent's mode of lending labourers prepared land for planting potatoes is good, and has long been practised in Scotland.

We differ from our correspondent on the subject of education; but do not the less respect his good intentions towards the poor, so far as he has expressed them. We would no more recommend the poor man to seek his happiness in political clubs, in gambling, or in public houses, than he would; and if the labouring classes had wherewithal to be happy at home, they would be found there, in their gardens, and with their families. Education we regard as a means to this end, and to every other which is conducive to human happiness; and the time, we trust, will soon come, when the right to education, useful practical education, at the public expense (as in some states of America), will be acknowledged by the constitution of the country, as belonging to all. The transition state in which we now are must unquestionably lead to the political discussions deprecated by our correspondent; and the evils which it produces no one can regret more than we do: but this effect can only cease with the causes that have occasioned it; viz., ignorance on the part of the people, and misgovernment on the part of their rulers. — *Cond.*

ART. VIII. *London Horticultural Society and Garden.*

MARCH 20. 1832. — The chairman, Dr. Henderson, announced the second part of Vol. I. of the Society's *Transactions*, new series, to be ready for delivery to the fellows. Notice was also given that the exhibition of camellias would take place on the 3d of April, and that Banksian medals would be bestowed on the best collections.

Read. Considerations upon some of the more important vital functions of plants; by the Rev. Levison Vernon Harcourt.

Distributed. Catalogues of the trees in Bartram's Botanic Garden, near Philadelphia; Robert Carr, proprietor. Cuttings of the Beurré Diel, Easter Beurré, and Beurré rance, kinds of pear; and of the Reinette de Canada, and Boston russet, kinds of apple.

Exhibited. *Camellia japonica rosea*, from J. Allnutt, Esq.

Also, from the Garden of the Society. Crocuses, *Camellia reticulata*, and a hybrid azalea originated between *Azalea indica* and *A. indica* var. *phœnicea*.

April 3. — *Read.* A paper on the manufacture of Indian rubber from the common garden fig tree; by John Osborn, Esq. Another paper on the cultivation of the garden grounds at Evesham, in Worcestershire; by Edward Rudge, Esq.

Distributed. Grafts of Bequène musqué, and Passe-Colmar, kinds of pear; and of the Golden Harvey and Dutch mignonne, kinds of apple; and seeds of a hybrid *Gladiolus*.

Exhibited. *Hovea ilicifolia*, from Mr. H. Lowe of the Clapton Nursery. *Canna iridiflora*, and *Enkiánthus quinqueflorus*, from Wm. Wells, Esq. *Maxillaria Harrisoniæ*, from Edward Gray, Esq. Wax flowers, from Mr. Cornish. *Acacia pubescens*, from Messrs. Rollisson. Oranges and lemons, from H. M. Dyer, Esq. A sentinel thermometer, regulated by the expansion of air acting upon a delicate mercurial balance, invented by Mr. John Lindley. Drawings of camellias, from John Allnutt, Esq. The Council having announced that there would be an award of a large silver medal and Banksian medals for the best exhibition of camellias at the Meeting of this day, collections were received from Messrs. Chandler,

Loddiges, Smith, Rollisson, Wells, Allnutt, and Gray. It was decided "that Messrs. Chandler and Sons are entitled to the first prize of the large silver medal; and that Messrs. Loddiges and Mr. Smith are entitled to the Banksian medals;" and it was further recommended that the same medal be given to Wm. Wells, Esq.

Also, from the Garden of the Society. *Caméllia reticulàta*, *Justícia coccinea*, *Hàmánthus coccineus*, *Amýgdalus communis* var. *macrocarpa*, *Prímula verticillàta*, *O'xalis cernua*, and a species of *Eupatórium*.

It was announced from the chair that six lectures on botany, applied to horticulture, would be given on the following Wednesdays, at three o'clock; namely, May 9. 16. 23. and 30., and June 6. and 13.; and fellows desiring tickets for ladies were requested to apply for them in writing. (See p. 380.)

April 17. — Read. A description of a double range of forcing-pits, heated by hot water; by R. H. Roundell, Esq.: and a paper on the grafting of the walnut tree; by T. A. Knight, Esq.

Exhibited. Very beautiful specimens of *Magnòlia Soulangeàna*, from Messrs. Brown of Slough. 100 species and varieties of *Narcíssus*, *Anemòne horténsis* *supérba*, *Anemòne horténsis* *purpùrea*, and the High Admiral variety of *Anemòne coronària*, from Mr. James Young. A new and very handsome species of *Solànum*, from Chiloe, from Mr. H. Low of Clapton. A small plant, with two very fine bunches of flowers, of a hybrid *Rhododéndron arbòreum*, *Magnòlia conspícua*, and *Wistària Consequàna*, from Mrs. Marryat. *Caméllia japónica imbricàta*, *japónica Róssii*, *japónica Welbankiàna*, and two seedlings, from J. Allnutt, Esq. *Magnòlia conspícua*, and twenty sorts of *Caméllia*, from Mr. Richard Chandler. Fine specimens of Hunt's Duke of Gloucester apple, and of Beurré rance or Hardenpont pear, from Thomas Hunt, Esq. A hybrid *Cáctus*, and *Caméllia Sasánqua ròsea*, from the Comte de Vandes.

Also, from the Garden of the Society. Four sorts of *Ribes*, two sorts of *Pýrus*, double-flowering peach, white-flowering peach, double-flowering furze, *Azàlea índica phænicea* and *índica àlba*, *Erythrìna herbàcea*, *Prúnus sínensis*, *Hàmánthus multiflórus*, yellow Chinese rose, *Magnòlia Soulangeàna*.

May 1. — Read. A paper on the construction of a hot-bed, to be heated by means of hot water; by W. H. Nash, Esq. A paper on the construction of a perpetual hot-bed; by John Osborn, Esq.

Exhibited. A hybrid *Cáctus*, from Walter Boyd, Esq.; raised by his gardener, Mr. Pressley. *Beaumóntia grandiflòra*, from Alderman Copeland. *Èrica arbòrea* and *mediterrànea*, from Mr. Wood, of Maresfield. *Clívea nóbilis*, and a narrow-leaved variety of *Hòvea Célsii*, from Messrs. Rollisson. Two sorts of litchis, from J. Reeve, Esq. *Azàlea sínensis*, *Templetònia retùsa*, *Erythrònium lùteum*, and *aurículas*, from W. Wells, Esq. Young's seedling apple, from Mr. James Young. A sowing-machine, from Lord Vernon.

Also, from the Garden of the Society. Flowers. *Calceolària bícolor* and *integrifòlia angustifòlia*, *Gesnèria bulbòsa* and *macrostàchia*; *O'xalis floribúnda* (of Lindley in the *Botanical Register*), *O. ròsea* var. of others; *Prúnus doméstica* *flòre plèno*, and *serrulàta*; *Amelánchier ovàlis* and *Botryàpium*; *Ribes àureum præcox*, *àureum serótinum*, *àureum sanguineum*, *sanguineum*, *cèreum*, and *tenuiflórum*; double-flowering furze, tulips. — Vegetables. Leeks, Flanders spinach, Knight's protecting broccoli.

May 15. — Exhibited. Seedling *Caméllias*, from Mr. Wells. Tulips, from Mr. H. Groom. Lettuces, from Mr. Hunt. *Erythrìna Crísta gállì*, from Mr. Mills; a fine specimen, 6 ft. high. *Pæònia Mòutan ròsea*, from Messrs. Chandler. Cucumber, from Mr. F. Turner, Eton College. A beautiful collection of varieties of heartsease, from Mr. James Young.

Also, from the Garden of the Society. *Pæònia Mòutan papaveràcea*,

ròsea, and *Banksiana*; *Lupinus nootkatensis*, and a species from Mr. Drummond. *Calceolaria bicolor* and *integrifolia angustifolia*, *Prunus Capollin*, *Pyrus spectabilis* and *nivalis*. *Ribes aurcum serotinum*, *floridum parviflorum*, *tenuiflorum*, and *inèbrians*. *Halèsia tetràptera macrocarpa*, *Ròsa Bánksia lùtea*, *Wistària Consequàna*, double-flowering furze, azaleas, Pitmaston seedling lilacs, *Crataegus oxyacanthoides*, *Cytisus ruthenicus* and *elongatus*, *Vèlla Pseudo-Cytisus*, *Pris susiana*, tulips, a species of *Amelanchier* from Mr. Douglas, seedling pæonies.

Professor Lindley's Lectures. — To increase the popularity of the Horticultural Society, and for this purpose to attract the attention of the ladies (in all things, where men are concerned, the most powerful agents), the Council last year engaged Mr. Lindley to deliver three lectures on the connection of botany with horticulture. Being on a tour at this time last year, we had no opportunity of hearing these lectures; but this year we have heard two, and mean to attend the remainder of the course, which, we understand, is to extend to six. We must say that we have been highly gratified, not only with Mr. Lindley's philosophic views, but with the unaffected, clear, distinct, and, in short, admirable manner, in which he delivered himself. A proof of Mr. Lindley's success in making himself understood will be found in the notes which we intend to give of these lectures: those of the first, subjoined below, were written entirely from recollection, by one of his female auditors, before totally unacquainted with the subject. We sincerely hope that the Council will prevail on Mr. Lindley to enlarge these lectures, by treating of vegetable geography, and some other matters; and then to publish them, at such a low price as would permit them to find their way into the hands of every apprentice and journeyman gardener. The Society ought to purchase the MS.; and then print the lectures, and sell them at cost price. — *Cond.*

LECTURE I. Relation of Botany to Horticulture; General View of the Subject; Nature of Plants; Vegetable Tissue. — Mr. Lindley began with stating that he had been induced to give a second series of lectures on the subject of botany, as connected with horticulture, because, in those which he gave last year, he had only touched on a few of the most striking points, and did not follow a regular system, as it was his intention to do at present. His object now was, to give his hearers a general view of the whole subject; but, in doing this, he had many difficulties to encounter: he had no elementary book to refer to, as all such that he was acquainted with either treated on botany as a science, and, of course, entered into its details more deeply than was suited to his purpose; or related solely to the practice of horticulture, to which he meant only slightly to advert. He intended to treat of botany merely as connected with horticulture; but it was difficult to draw a line to decide how far he ought to go. Botany was generally divided into three parts: one related to the structure of plants, another to their functions, and the third to the terms employed to designate them. The two former were intimately connected with horticulture, as he should show hereafter; and it was even difficult to dispense with the latter, as it was scarcely possible to speak of botanical facts without using the terms usually applied to them. The professor, however, assured his auditors that he would endeavour to explain himself in language that would be easily understood by all; and that he would avoid, as much as possible, entering into any minute or wearisome details.

Botany ought to be studied by every horticulturist. Some horticultural operations are so dependent on a knowledge of vegetable physiology, that it is impossible fully to comprehend them without reference to that science. Among these may be reckoned the usual means of propagating plants by buds and cuttings; of procuring improved varieties by hybridising; of multiplying them by grafting; and of rendering them fertile, or of checking their excessive fecundity, by the choice of situation, or by regulating the

degrees of heat, light, and air, to which they are exposed. To know how to effect these ends, the horticulturist ought to understand something of the nature of plants generally, to be aware of their natural affinities, and to know the climates in which they are indigenous. At the same time, it is perfectly true that an excellent theorist may be unsuccessful in gardening, from a want of that dexterity which can only be acquired by practice; and also that a man may be a good practical horticulturist without knowing any thing of botany, as he may have learned all that is necessary for the well-doing of the plants under his care empirically, from habit and experience. Knowledge founded only on experience must, however, necessarily be extremely limited; and it is always safer to recur to principles, which must, if sound, be applicable to every possible emergency.

As a popular instance of the utility of a knowledge of the natural affinities of plants, to the practical horticulturist, the professor mentioned the impossibility of grafting a lilac on an apple or a currant tree, notwithstanding the apparent resemblance in shape between its flowers and those of some varieties of the latter genus; while the lilac might be grafted upon the ash: both belonging to the same natural order, and, of course, an affinity existing between them. No union can ever be effected by grafting one plant upon another, unless such affinity exists between them; and the vulgar notion, that it is possible to produce a black rose by grafting a rose on a black currant, Mr. Lindley assured his auditors he considered almost too ridiculous to be mentioned. He added that hybridising was subject to the same laws and limitations as grafting. With regard to the importance of a knowledge of the natural climates and habits of plants, the professor mentioned the fact, that some plants were fertile only on a north wall, while others required the south; that some would not live in iron hot-houses, while others grew more vigorously in such a situation than in others; and that these results might have been confidently anticipated, before the experiment was tried, by any one acquainted with the habits of the plants referred to.

Having thus demonstrated the importance of at least a slight knowledge of the principles of botany to the practical horticulturist, Mr. Lindley proceeded to take a general view of those principles; and began by considering the nature of plants. All vegetable substances consist of an immense number of atoms, or small parts, held together by the principle of adhesion, and called by the general name of tissue. This tissue is of three kinds: cellular, fibrous, and vascular. Cellular tissue is composed of a great number of small cells or bladders, each formed of a thin imperforate membrane, through which, however, the sap contrives to circulate by means of invisible pores. These cells are of various shapes, and are characterised by their facility in breaking, or brittleness. Numerous vegetable substances are composed entirely of cellular tissue, but others only partially: as an instance of the first, the professor mentioned the fungus which, by Captain Ross and his companions, has been termed red snow. Cellular tissue forms the pith, or medullary substance, of trees, the flesh of fruits, &c. &c. To exemplify the brittleness of cellular tissue, Mr. Lindley exhibited a specimen of Chinese rice paper, made from the medullary substance of the *Æschynomene paludosa Roxb.* [See *Gard. Mag.*, vol. v. p. 309.] Fibrous tissue is composed of a number of hollow tubes, tapering at both ends, each not more than the twelve-hundredth part of an inch in diameter, and yet having the vacancy in the centre much larger than the sides. The albumen and inner bark of trees are formed of this substance; the toughness of which the professor illustrated by exhibiting a piece of Russian *bast* mat, made of the inner bark of the lime. Vascular tissue comprehends the spiral vessels and cylindrical ducts, for conveying air and sap.

Plants are provided with roots, stems, leaf-buds, leaves, flowers, fruit, and seed; all performing important, though distinct, functions, and all

more or less essential to the process of vegetation. Roots are of various kinds and shapes; but their use is always the same, viz. to extract moisture from the ground, and to serve as a channel for conveying it to other parts of the plant, where it is afterwards converted into sap. Roots, properly so called, can seldom be propagated by division; and when bulbs produce offsets, each is complete in itself, and not a part of the old root. The mere circumstance of part of a plant being buried in the earth does not make it a root. The tubers of potatoes, for example, partake more of the nature of branches than roots, producing buds or eyes, each of which is capable of forming a perfect plant; and bearing to be divided without destroying the vital principle, which ordinary roots will not. Stems or trunks are highly important, both as being the channels to convey nourishment to the leaves, flowers, and fruit, and as being, in trees, the part convertible into timber for the purposes of profit. Leaf-buds (so called to distinguish them from flower-buds) in trees are, in fact, trees in embryo, and afford the only certain means of multiplying varieties. The brown scales that envelope these buds, when they first burst from the tree, are diminished and imperfect leaves of the preceding season's formation, and generally drop off as soon as the inner leaves expand. Leaves may be called the lungs of plants, as through them the sap is exposed to the influence of the atmospheric air. They are furnished with pores, which can imbibe nourishment as well as throw off superfluous moisture. Petals are coloured leaves, useful for protecting the parts necessary for the fructification of seed. There is no essential difference, in the eye of the botanist, between the calyx and the corolla. Every flower is provided with one or more threads or filaments, called stamens; each of which is loaded with a case, or anther, containing a kind of dust called the pollen. This powder, which is necessary to the fecundation of seeds, is conveyed to the seed-vessel (a thick cell or protuberance containing the seed, and growing in the centre of the flower) by means of a tube-shaped body that usually surrounds it, called the style; the stigma or head of which is the only part about the whole plant which is not covered with a membrane, and which, consequently, admits the free passage of the pollen. Plants having only stamens are called males, and those having only styles female; while the majority of plants, possessing both, are called bisexual. This system was developed by Linnæus. Varieties of plants cannot be propagated unvaryingly by seed; as every plant thus raised is a distinct individual, often differing considerably from the parent plant. Double-blossomed plants very seldom bear seed; and Mr. Lindley mentioned the double-blossomed cherry, as an instance of a plant which could only be propagated by cuttings. Some exceptions, however, occur to this rule. Mr. Lindley concluded his observations on the sexes of plants by quoting some verses from Dr. Darwin. The sap is the nourishment of plants. Various theories have been broached respecting its circulation, which Mr. Lindley promised to explain in a future lecture. It is formed from aqueous particles imbibed by the root, and forced up the stem to the leaves; where it acquires an additional portion of oxygen from the atmospheric air, and returns to the root, imparting nourishment to all the different parts of the tree in its progress. It rises in the spring, and sinks in the winter: during this season, plants are generally in a dormant state. Contrary to what might be expected, the sap appears first in motion at the extremity of the branch. Air, light, and heat are indispensable to plants; and, according as one or more of these important agents are deficient, the plant is imperfect. If there were not enough light, the plant would not attain its proper colour; and without a due proportion of air and warmth, fruit would be deficient both in flavour and appearance. In conclusion, Mr. Lindley quoted a passage from "an elegant and enlightened author," remarking on the constant change which pervades all nature; and that all things after death sink into corruption, only to rise again in new forms of beauty and vigour. — *J. W. L.*

ART. IX. Covent Garden Market.

<i>The Cabbage Tribe.</i>		From	To			From	To	
		£ s. d.	£ s. d.			£ s. d.	£ s. d.	
Cabbages, per dozen :				Small Salads { per half sieve	0 1 6	0 2 0		
White - - - - -	0 0 9	0 1 6	Watercress, per dozen small	0 0 2	0 0 3			
Plants, or Coleworts - -	0 2 0	0 3 0	bunches - - - - -	0 0 6	0 0 0			
Cauliflowers, per dozen -	0 6 0	0 12 0	Burnet, per bunch - - -	0 0 1	0 0 0			
Broccoli, per bunch :			<i>Pot and Sweet Herbs.</i>					
White - - - - -	0 1 0	0 2 0	Parsley, per half sieve -	0 1 6	0 2 6			
Purple - - - - -	0 1 0	0 1 6	Tarragon, per dozen bunches	0 3 0	0 0 0			
<i>Legumes.</i>				Fennel, per dozen bunches	0 2 0	0 3 0		
Peas, per half sieve - -	3 3 0	0 0 0	Thyme, per dozen bunches	0 2 0	0 0 0			
Kidneybeans, forced, per			Sage, dried, per dozen bun.	0 1 0	0 0 0			
hundred - - - - -	0 2 0	0 2 6	Mint, per dozen bunches -	0 1 6	0 2 0			
<i>Tubers and Roots.</i>				Peppermint, dried, per doz.				
Potatoes - - - - -	3 10 0	5 0 0	bunches - - - - -	0 1 6	0 3 0			
{ per ton	0 3 6	0 5 0	Marjoram, dried, per dozen					
{ per cwt.	0 2 0	0 2 6	bunches - - - - -	0 1 0	0 0 0			
{ per bush.	0 2 0	0 2 6	Savory, dried, per doz. bun.	0 1 0	0 0 0			
Kidney, per bushel - -	0 2 0	0 2 6	Basil, dried, per doz. bun.	0 1 0	0 0 0			
Scotch, per bushel - -	0 2 6	0 0 0	Rosemary, per doz. bunches	0 5 0	0 0 0			
New, per pound - - -	0 0 6	0 1 6	Lavender, dried, per dozen					
Jerusalem Artichokes, per			bunches - - - - -	0 4 0	0 0 0			
half sieve - - - - -	0 1 0	0 1 6	Tansy, per dozen bunches	0 1 0	0 0 0			
Turnips, White, per bunch	0 1 0	0 1 6	<i>Stalks and Fruits for Tarts,</i>					
Carrots :			<i>Pickling, &c.</i>					
Old, per bushel - - -	0 5 0	0 6 0	Rhubarb Stalks, per bundle	0 0 6	0 1 0			
Young, per bunch - -	0 0 9	0 1 0	Angelica Stalks, per pound	0 0 0	0 0 6			
Horn, per bunch - - -	0 1 0	0 1 3	<i>Edible Fungi and Fuci.</i>					
Red Beet, per dozen -	0 1 0	0 1 6	Mushrooms, per pottle -	0 1 0	0 1 6			
Horseradish, per bundle -	0 3 6	0 5 0	Morels, per pound - - -	0 14 0	0 0 0			
Radishes :			Truffles, per pound :					
Red { per dozen hands (24			English - - - - -	0 12 0	0 0 0			
to 30 each) - - -	0 0 4	0 0 6	Foreign - - - - -	0 14 0	0 0 0			
White Turnip, per bunch	0 0 1	0 0 0	<i>Fruits.</i>					
<i>The Spinach Tribe.</i>				Apples, Dessert, per bushel :				
Spinach { per sieve - - -	0 0 6	0 0 9	Reinette grise - - -	1 0 0	2 10 0			
{ per half sieve - -	0 0 0	0 0 6	Apples, Baking, per bushel	0 8 0	1 0 0			
Sorrel, per half sieve -	0 1 0	0 1 6	Peaches, per dozen - -	2 2 0	0 0 0			
<i>The Onion Tribe.</i>				Almonds, per peck - - -	0 7 0	0 0 0		
Onions, Old, per bushel -	0 6 0	0 7 0	Gooseberries, per half sieve	0 5 0	0 6 0			
Green (Ciboules), p. buc.	0 0 4	0 0 6	Strawberries (forced), per oz.	0 0 6	0 1 0			
Leeks, per dozen bunches	0 1 6	0 2 0	Pine-apples, per pound -	0 6 0	0 14 0			
Chives, per dozen roots -	0 0 0	0 1 0	Hot-house Grapes, per lb.	0 5 0	0 12 0			
Garlic, per pound - - -	0 0 0	0 1 0	Cucumbers, frame, p. brace	0 1 0	0 2 6			
Shallots, per pound - -	0 0 0	0 1 0	Oranges { per dozen - - -	0 0 9	0 3 0			
<i>Asparaginous Plants,</i>				{ per hundred - - -	0 4 0	1 0 0		
<i>Salads, &c.</i>				Lemons { per dozen - - -	0 0 9	0 2 0		
Asparagus, per hundred :			{ per hundred - - -	0 4 0	0 16 0			
Large - - - - -	0 5 0	0 6 0	Sweet Almonds, per pound	0 2 6	0 3 0			
Middling - - - - -	0 3 0	0 4 0	Nuts, per peck :					
Small - - - - -	0 1 6	0 2 6	Spanish - - - - -	0 5 0	0 0 0			
Lettuce, per score :			Barcelona - - - - -	0 6 0	0 0 0			
Cos - - - - -	0 1 6	0 2 0	Brazil, per bushel - -	0 14 0	0 16 0			
Cabbage - - - - -	0 0 4	0 0 6						
Celery, per bundle (12 to 15)	0 0 9	0 1 6						

Observations. — I have delayed sending the list some days, in consequence of the lateness of the season, from which circumstance the prices of many of the leading articles have not been sufficiently settled to enable me to determine their range ; consequently, those attached to the list must be considered as for the last few days only. Asparagus, which at this season is generally a leading article, has, as yet, been furnished in very small quantities, and by no means of good quality ; the absence of solar heat, and the prevalence of cold winds and frosty nights, have prevented it from coming to size, colour, or flavour. Peas are as yet only spoken of, only two half sieves on Saturday in the market ; consequently, the price attached to that article in the list must be considered as exclusively confined to the day ; but, as the season is likely to be still further retarded by the continued prevalence of northerly and easterly winds, no supply can be immediately looked for, and, as it is an article in demand, good prices may be confidently anticipated. Cauliflowers begin to be brought rather freely for the season : as yet they have been small, and not

very good; the stock in growth is said to be small, the supply through the season will necessarily be limited, and may realise good prices. Cabbages of excellent quality have been in good supply, at moderate prices.

Broccolies have been very abundant, and of good quality, owing to the mildness of the winter, the frost never having materially affected the growth: the varieties principally furnished have been of the later sorts; and perhaps in no other instance does the improvement in gardening become more apparent, than in the sorts of late broccolies now produced, almost each individual gardener having a good variety of his own growth. Rhubarb, which has for some years past been largely cultivated, is still a subject of increasing interest, and more extensively in demand than ever: on the 5th May no less than eight entire waggon loads packed in bulk, with an equal quantity in smaller proportions, were brought in and sold in this market alone: one cultivator, Mr. Myatt, of New Cross, Deptford, had three waggon loads; he has, I believe, nearly twenty acres in culture. Of broccoli, on the same day, were sent five waggon loads, and of broccoli sprouts three waggon loads.

Gooseberries are now coming in abundantly, the crop said to be good; and, from the extensive breadth under culture, a very full supply may be expected: the prices of these and other ordinary fruits will, of course, be moderate, but the quantity will compensate the growers, who have for the last two seasons suffered severe loss, from short crops of fruit, middling prices, and the general depression arising from many other causes.

Strawberries (forced) have been very plentiful and excellent. Grapes are now coming more freely to market, as yet they have been in short supply, and in very limited demand.

Our stock of apples is now confined to some fifty or a hundred barrels of reinettes grises, the holders of which keep them at a high price; the consequence of which is, they are in little demand, although we have little prospect of early fruit to supersede the use of them. The stock of winter onions is almost quite exhausted, hitherto it was customary to keep over a supply until Midsummer; but, in consequence of the introduction of earlier spring varieties of onions, the practice is discontinued; more particularly as the prices lately obtained would not warrant holding over any quantity.

Potatoes, the still leading article of supply in the metropolis, have been very low in price since Christmas; so much so, that the growers in the distant districts have given up sending them; in consequence of which the stock on hand is very short, and, as the spring is very backward, no immediate supply can be expected. A rapid and considerable rise in value has taken place, particularly in Scotch reds, which, during one week, rose 25s. per ton. — *G. C. May 21. 1832.*

ART. X. Obituary.

DIED, March 21., *Mr. Archibald M'Naughton*, formerly of Hackney, but, at the time of his death, residing with some relations of his wife, in the parish of Monigill, in Perthshire. Mr. M'Naughton was an occasional contributor to this Magazine, and the author of the *Life of a Jobbing Gardener*, which appeared in our First Number. (Vol. I. p. 24.) A copy of his will has been sent us, together with a number of papers, which we have not yet had time to examine.

Died, April 7., at his residence in the New Road, *Mr. Jenkins*, of the Marylebone and Regent's Park Nurseries. He was a man of the greatest industry and perseverance; and, beginning with nothing, he accumulated considerable property. Some account of his life is promised us for our next Number.

THE
GARDENER'S MAGAZINE,
AUGUST, 1832.

ORIGINAL COMMUNICATIONS.

ART. I.— *General Results of a Gardening Tour, during July, August, and part of September, in the Year 1831, from Dumfries, by Kirkcudbright, Ayr, and Greenock, to Paisley.* By the CONDUCTOR.

(Continued from p. 266.)

FROM the subject of cottages, the transition to that of towns and villages is easy and natural; but we shall enter no farther into it, than to supply a few materials for thinking to head-gardeners, and young men who aspire to (what in these transition times, every young gardener ought to aim at) the general management of a demesne, or of a landed estate.

The towns and villages in the west of Scotland have partaken of the general improvement of the country, and more particularly the seaports, and the manufacturing districts of Kilmarnock, Paisley, and Catrine. The most stupendous public work which we have witnessed, in any of the places alluded to, is what is called Shaw's Waterworks, the contrivance of that most inventive engineer, Mr. Thom of Rothsay.

Greenock is situated at the bottom of a sloping hill or ridge, the top of which is upwards of 500 ft. above the level of the Clyde. To the top of this ridge Mr. Thom has conducted, along the summits of other ridges, from a distance of six miles, a copious supply of water, not only for all the ordinary purposes of the town, but for driving machinery. The water is collected into reservoirs, at the distance of several miles from

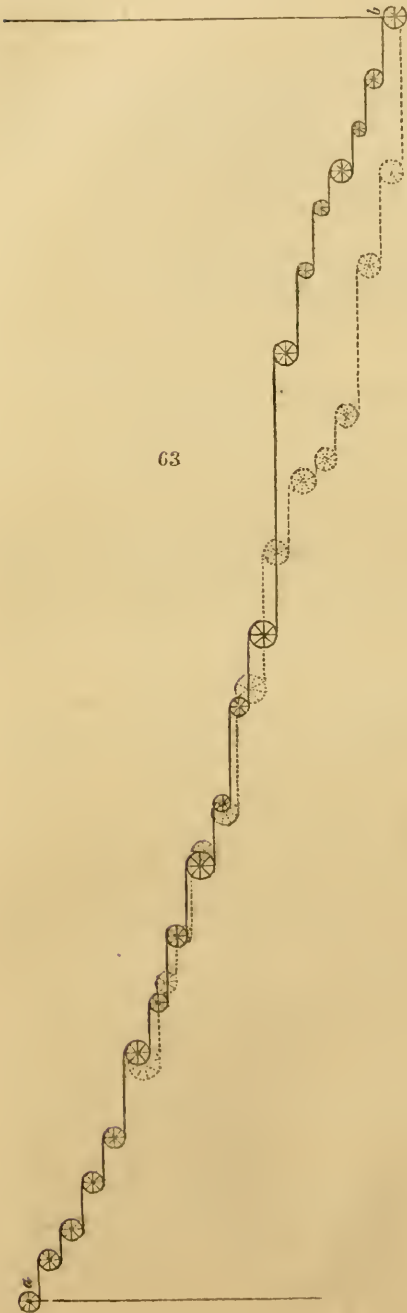

Greenock; and each of these reservoirs is capable of containing a supply for the consumption of the inhabitants, for more than six months; “so that not only the surplus waters of one wet season may be retained for supplying the dry season of the same year, but the surplus of several wet years may be stored up to supply a drought of several years’ duration, should such ever occur.” The water is brought to the summit of the hill in such a quantity as to supply 1200 cubic feet per minute, which Mr. Thom estimates, on a fall of 30 ft., as equal to a Bolton and Watt’s steam-engine of fifty-horse power. In what manner the water is applied in succession to the mills, will be easily understood by the inspection of *fig. 63.*, which is an imaginary section from the summit of the hill (*a*), through all the water-wheels, to high watermark on the Clyde (*b*). The line of wheels dotted, shows that there are two series of situations for mills. The same aqueduct supplies water for the inhabitants at the rate of 2 cubic feet per head per day.

The filtration of this water is effected in 3 filters, invented by Mr. Thom, which are thus formed: — “ Each filter is 50 ft. long, 12 ft. wide, and 8 ft. deep. The water is made to percolate through them, either upwards or downwards, at pleasure. When it percolates downwards, and the supply of filtered water becomes sensibly less (which, after some time, must happen to every filter, by the lodgement of sediment), then, by shutting one sluice and opening another, the water is made to pass upwards with considerable force, and, carrying the sediment along with it, to fall into a waste drain made for that purpose. When the lodged sediment is thus removed, and the water begins to run clear, the direction of the sluices is again changed, and the filter operates as before.”

Among the most ingenious arrangements connected with these works are, the self-acting sluices to the different reservoirs, by which both the reception and the delivery of water are regulated to the greatest nicety, with a view to the most rigid economy of the fluid; but it would be deviating too far from the direct objects of our work to describe them.* What has been effected by Mr. Thom should encourage gardeners, and others connected with the improvement of landed property, never to think any end, which is at all desirable and possible, too difficult of attainment.

The system of drainage, or sewerage, in these towns, is as bad as in most English ones. All towns situated on rivers or streams drain into them, instead of into main sewers constructed parallel to their sides. This is a most important point in the system of town arrangement; and though it has been utterly neglected in the case of London, and the waters of the Thames have become, in consequence, unfit for use, yet this ought rather to have served as a warning beacon for provincial towns, than as an object of imitation. The omission of such sewers in Scottish towns is the more remarkable, as the inhabitants are fully aware of the value of liquid manure, a great quantity of which might be thus saved from waste. If the evil be not checked speedily, it will be found a very serious nuisance at no distant period, when, in addition to contaminating the air, it has polluted the only waters accessible to the poor.

To render these sewers efficient for all the purposes for which they are calculated, they should be commenced farther up the river, and be continued farther down its banks, than

* We have sent the pamphlet (*A brief Account of Shaw's Water Scheme, &c.*, Greenock, 8vo, pp. 88., 1829), in which these works are described, to the editor of the *Mechanic's Magazine*, in whose most valuable and widely circulated work they will probably be recorded for the benefit of engineers.

the town reaches; and their lower extremities should deliver their contents into a pond, for evaporation, at least a mile from the town. In many situations, instead of evaporating the water in the pond, it might be employed, as it comes from the town, to irrigate adjoining grass lands, or pumped up into water-carts, to be used, in various ways, as liquid manure. In some cases, it might be worth while to erect a small steam-engine and scoop-wheel, like those in the fenny districts, for the purpose of raising the comparatively thinner waters of the sewer to an elevated channel, which channel might convey them to a distance, for the purpose of irrigation. By having two ponds for the deposit, the dense mud of the one pond would be drying, while the other pond was filling and the mud being deposited, as in the case of the ponds near Paris employed in evaporating the material which forms the *pot-drette*. Were a sewer of the description alluded to carried down the London and Southwark sides of the Thames, at a short distance from its banks, going on a level round the docks, and under the canals, &c., the quantity of most valuable manure that might be deposited on the meadows of Essex, and the shorelands of Kent, almost exceeds calculation. The water of the Thames, being thus left pure, might be pumped up by steam-engines, for the supply of the metropolis. This is an arrangement that must sooner or later be adopted, even in London, and in all old towns; and it ought to be one of the first objects of attention, in forming new congregations of houses, in every part of the world.

A second nuisance in Scotch towns arises from the absence of certain conveniences to which we alluded in our preceding article (p. 265.), as being generally wanting in cottages. It is difficult for a stranger to the suburbs of the towns of Scotland to imagine the state in which he will find the banks of the Nith, within watermark, at Dumfries; those of the Clyde, at Greenock; and the seashore, at Ayr. The latter town has just completed a very handsome spire to the town-hall from the design of an architect of great taste, Mr. Hamilton of Edinburgh; and the inhabitants are now occupied in rebuilding Wallace Tower, and placing in it a gigantic statue of Wallace, by the celebrated sculptor Thom. Surely, therefore, they might spare funds for public water-closets, so much wanted, of which we here suggest two forms (*figs.* 64. and 65. and *figs.* 66, 67, and 68.). The former would be a good substitute for the hovel on the quay at Greenock. The contents of the tanks of these buildings might be drawn off by one of Shalder's pumps, placed at some distance from them, and connected by a drain. At Ayr, these contents

might be conveyed in deep close carts, and, at Greenock, in steam-boats, to the farmers. For details on this subject see *Encyc. of Cottage, Farm, and Villa Architecture*, § 37, 38, and 39.

64



65

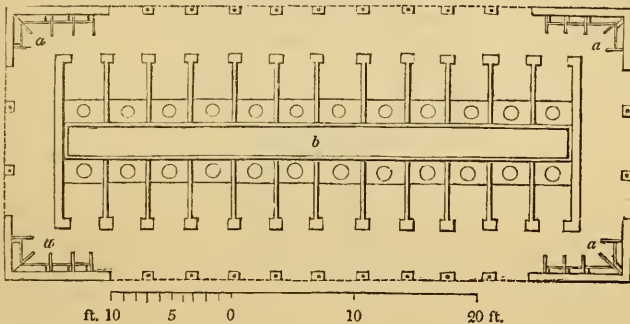

a, a, a, a, Aquariums.
b, Cistern of water, which, by means of a contrivance connected with the door of each closet, supplies a jet of water to the basin, every time the door is opened, and every time it is shut.

With the increase of population in these towns *the churchyards* have necessarily become too small; and this, we trust, will, at no distant period, lead to general cemeteries, which may, at the same time, be rendered very ornamental. The churchyards of the villages and country parishes are also almost every where too small; and, as the author of *Necropolis Glasguensis* (Glasgow, 8vo, 1831) observes, they are generally in a neglected state. We regret that the resident clergy do not seem to partake in our views on this subject; otherwise they might do much, with very little trouble or expense: for we are sure there is no gardener or nurseryman who would not supply such trees as might be wanting, and even plant them; and the expense of mowing the grass, if the parish could not afford it, we doubt not would be volunteered by the resident ploughmen or other workmen belonging to the parish. A little smoothing of the rougher parts of the sur-

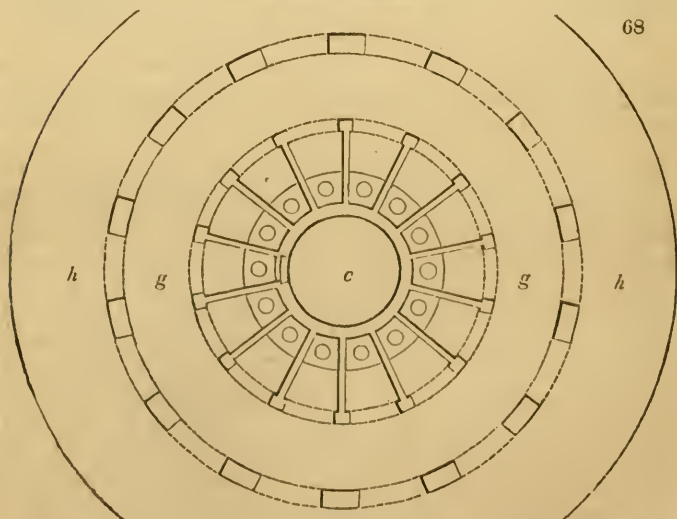
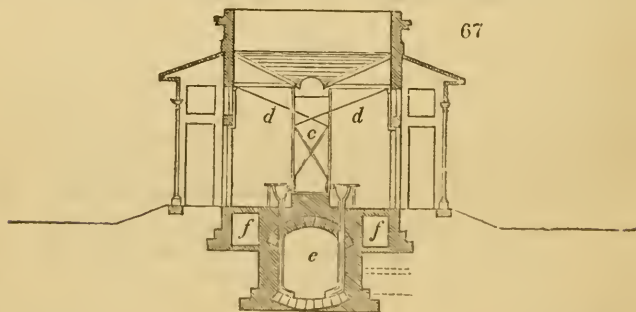
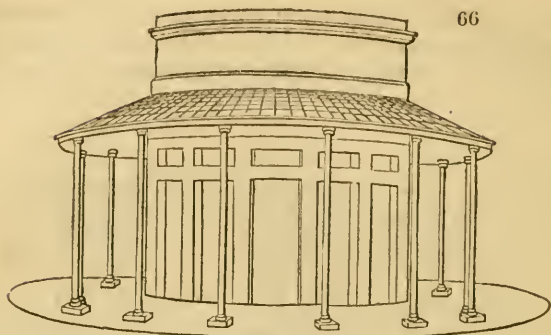

ft. 10 5 0 10 20 ft.

c, Cistern of water.
d, Lines to plugs of supply, acting by the opening and shutting of the doors.
e, Tank. *f*, Ventilating drains. *g*, Veranda. *h*, Inclined plane.

face ; a walk, or walks, judiciously led round and through the area, and neatly gravelled or paved ; and a few trees and shrubs, by no means two of a sort in the same churchyard, are all that is wanting. We are justified by the general character of gardeners for liberality and patriotism, independently of what they did in the case of Burns's monuments at Dumfries, and at Kirk Alloway, and in Kirk Alloway churchyard, in concluding that these articles and labours would be readily supplied by them ; and masons, we are certain, would not less willingly assist in repairing the walls or tombs ; and road-makers in bringing in gravel, or in Macadamising or paving the walks.

The editor of the *Scotsman* observes (29th of June, 1831) that the neglected state of the churchyards in Scotland is a disgrace to the country ; and we agree with him in thinking that this originates chiefly in the " deficiency of sentiment which belongs to the national character." We would therefore strongly recommend the improvement of churchyards, for the sake of cultivating a feeling, in which it is thus publicly acknowledged by a Scotsman, that (we) his countrymen are deficient.

The *villages* are proportionately defective with the towns ; but there are still evidences of improvement. That of Dalbeattie, ornamented as it is with its chapel of St. Peter's, and its fine garden, bears a slight resemblance to an English village. Catrine is decidedly the most regular in all its arrangements, and the cleanest. There are in this village four libraries, a school, and two chapels, independently of the parish church, supported entirely by the villagers. The manufactory of Mr. Buchanan, here, is a grand and admirably regulated establishment ; and the overshot water-wheel, 40 ft. in diameter, constructed of cast-iron buckets, with wrought-iron rods as arms, and, like Jones's patent carriage-wheels (*Ency. of Agr.*, 2d edit., § 2749. fig. 382.), acting on the suspension principle, is alone worth going many miles to see.

The most prosperous villages are those on the Clyde, of which Largs may be given as an example ; but, as the inhabitants are chiefly men of property, who have retired from business, it cannot be classed with Catrine, Dalbeattie, and other agricultural or manufacturing places. The great deficiencies in the Scotch villages, when compared with the English ones, are, the want of general cleanliness in the streets and houses, and the want of flowers and of flowering shrubs in the gardens. To these points, and especially the first, all that have any influence ought to direct their attention.

(To be continued.)

ART. II. *Extracts from Notes made during a Horticultural Tour in the Netherlands, and Part of France, in June and July, 1830.*
By Mr. T. RIVERS, Jun.

(Continued from Vol. VII. p. 279.)

MR. CHANTRELL, the English gentleman whom I mentioned, in my last, as being married to a Flemish lady, and having a country seat at St. Croix, near Bruges, I found a most agreeable companion, and an enthusiastic horticulturist. He is indefatigable in the culture of the species of *Erica*, and, having to contend with a soil rather inimical to that interesting family, deserves great credit for his pretty collection, selected from the nurseries round London, to which place he makes annually a horticultural visit. His mansion, he informed me, was formerly the residence of a bishop, and with the grounds, it forms a perfect specimen of a Flemish country residence, surrounded by a moat of clear, dark, stagnant water, with long straight avenues diverging from the house, like the rays of a circle. The grounds are quite flat, and the paths a soft black sand; but these soft paths and shady avenues, though so completely at variance with my English would-be-picturesque ideas, felt most exceedingly agreeable in a sultry July day; and as the Flemings, from the nature of a great part of their country, must have tame gardens, I admire their solid taste in consulting their comfort more than their eyes. A Flemish country house is also, it must be observed, merely a summer residence, as the inhabitants lock up the doors at the end of September, and, leaving their furniture, &c., to its fate, without the protection of even a single servant (a fact which certainly gives a very favourable idea of the honesty of the Belgians), resort to the town till the heat in spring reminds them of their cool avenues. Mr. Chantrell is generally fortunate in gaining prizes from the Horticultural Society of Bruges. In June, 1830, the principal prize was awarded to him for *Erica reflexa alba*, a fine specimen, and honourable mention was made of *Dryandra nervosa*, *Alstrœmèria pulchella*, *Játropha panduræfolia*, *Erythrîna laurifolia*. These specimens I saw, and admired their superior growth. In the grounds was a pole, perhaps 25 ft. high, closely covered with the twining stems of the *Aristolòchia siphon*, which formed the most beautiful verdant column I ever beheld. In the kitchen-gardens, the pear trees were, as usual here, flourishing; but the apples were sadly cankered and unhealthy; lettuces, in successive crops, were the principal vegetables; the cabbage tribe did not flourish, especially the cauliflower, which will not head in this neighbourhood.

In the afternoon we visited the garden of the Comtesse de Carnen, at Nalde. No place could be more at variance with the taste of an English gardener; the orange trees and green-house plants were placed in straight single lines in a square, enclosed with tall thin edges, each plant fastened by the stem to a small painted rail, and all trained with naked stems as standards. The effect was curious, and it did really seem quite ridiculous to see the poor myrtles, laurustinuses, bays, pomegranates, oleanders, arbutuses, and aucubas, with numerous oranges, looking more like mops than plants, with some of the stems of the myrtles not larger than a reed, and from 4 ft. to 6 ft. high; the heads of all being cut as round as a ball. The gardener appeared to think them the summit of perfection, and his eyes glistened at the praises which I gave him for the ingenuity and perseverance he had displayed; but when I explained to him, that with us they would all have been left in a state of nature, which we thought most ornamental, he shook his head most significantly, and seemed to pity us for having no taste. Common thyme is used here extensively as an edging for the borders, and the gardener said that it was the only aromatic herb known, or in use, in this part of Flanders. French cookery being general here, I was surprised at the dearth of what we call potherbs; but salad seems to be the staple article of vegetable food, for both rich and poor eat it most abundantly with every meal they take. The orange trees were for sale, and the gardener gave me the prices of some; for plants about 3 ft. he asked 15s. each, and standards about 5 ft. were 20s. each. The heads of these trees, however, had been so carefully formed into the ball-like shape, that, in England, they would have been ridiculous. A very high value was set on the large trees. The taste for orange trees is much more general in Flanders than in England. They were all in the finest health, but were grown in a compost that would puzzle an English cultivator, viz. black, moist, soft, peaty soil, mixed with cow dung and sheep dung in equal quantities.

A taste for rare and good plants is here generally diffused, and, I believe, it extends all over Flanders, as they have their societies and "expositions" at Bruges, Louvain, Courtrai, Brussels, Ghent, and every town of any importance in the country. The number of exhibitors here (Bruges), the last "exposition d'été" [summer show], which took place in June, was upwards of 100, and at Ghent it was nearly 300; almost all exhibited some good or rare plants. These facts more than any thing will show the diffusion of a refined taste for

horticultural productions; for in which of our cities, with the population of Ghent (80,000 to 90,000), shall we find 300 plant amateurs? At the Aigle d'Or [Golden Eagle] at Bruges, in a small garden not 60 ft. square, was the finest double *Althæa frutex* I ever saw, forming quite a tree; also a fine *Salisbùria adiantifolia*; *Cléthra arborea variegata*, *Acer palmata*, and numerous oranges: these, with many other rare plants, were arranged very prettily in the gardens, for the customers to admire while smoking their cigars; the landlord seemed quite aware of their value, and appeared to have a great taste for plants. To English gardeners, who are used to see evergreens in such profusion and perfection at home, it appears strange to find large bays and laurustinuses in tubs, and as carefully attended to as oranges. The want of our best evergreens, such as the above, and common and Portugal laurels, in the gardens and pleasure grounds of this country, is much felt by an English eye. It seems that the winters are too dry and sharp for them, and the soil too loose, being much like our sandy peat.

Walking in one of the streets of Bruges, I saw, through an open window, what appeared to be a very pretty garden in the heart of the city, and, upon enquiry, I found that it belonged to an opulent brewer, M. Buschaert. I obtained an introduction to him, and, as "un fleuriste Anglais," was most politely received. I was highly gratified with finding one of the sweetest town gardens possible to conceive, with serpentine walks and glades, and thickly planted with shrubs and trees, many of them rare. The effect was delightful and striking, and it was increased by my having but a moment before turned from the frequented streets of a populous city. Among his hardy trees, M. Buschaert pointed with evident pride to a beautiful specimen of the rare *Fagus cristata*, and to one of the *Pópulus grandidentatus*: a clump of hybrid azaleas seemed also to have his especial care, and his favourite varieties were named *Ne plus ultra*, *Morterii Genio*, *Tricolor Jacobs*, *Mortेरiana*, *Regina Belgica*, &c. &c. He had also some rare stove plants, and an extensive collection of pears *en quenouille*; all in the best order, and the place generally as neat as possible. I should think (from memory) between two or three acres were occupied by these gardens and a small orchard; but so surrounded by houses, that, had I not seen the garden through the open window, I should not have imagined such a place existed.

I next visited a pear amateur, M. Boukhout, and perhaps never felt more amused with an enthusiast. Numerous stocks were grafted (in the cleft manner) with new varieties for trial.

One that he called the lion, but which seemed to be the poire milon, or melon pear, he told me, with all the lively gestures of a Frenchman, was “très-grande,” très-superbe,” “très-délicieuse;” in short, that it was “the devil of a pear.” I narrowly scrutinised the shoots of this “*poire fameuse*,” and felt a strong conviction that it was the pear known in England as Uvedale’s St. Germain, or pound pear, recorded in your pages as being sometimes of great weight. I may here remark, that I am now exceedingly sceptical when I hear our Continental neighbours give descriptions of fruits or plants; experience has told me that what to their warm imaginations seems so grand and beautiful, to our business-like ideas assumes quite a different aspect.

In the neighbourhood of a city like Bruges, with a population of 40,000 inhabitants, we should suppose that, at least, one nursery would be found; but nothing of the kind exists, and the few plants exposed in the flower-market (*préfectoire*) are supplied by the small gardeners. Trees are cultivated in different gardens by amateurs*, and sold to help to pay the gardening expenses: economy is the order of the day; and an Englishman, unless an eyewitness, can scarcely form an idea to how great an extent it is practised.

Mr. Chantrell, to give me a thorough view of rural affairs, took me to spend a day with one of his tenants, who held a farm of 200 acres, and which, as all the Flemish farms are very small, was equivalent to a 500-acres farm of good land in England. The tenant, indeed, ranked as a large farmer; but the contrast between his mode of living and that of an English farmer of the same class was so striking, that, at the risk of being tedious, I will give you a short description. A long, low, brick building, with a thatched roof, the counterpart of many of the cottages in the fens of Cambridgeshire (by the way, the self-same method of building exists here generally; the farm-houses and cottages are all brick, the roofs thatched, and the gables raised a little above the roof), contained, at one end, two rooms (a parlour and kitchen), inhabited by the farmer and his family; the other end consisted of the stable and cowhouse; round the living-room, which was neatly paved with bricks and clean in the extreme, were three or four berths (I can call them by no other name, as they were round the sides of the room in the exact manner of the berths of a ship), and in these, containing neat beds, slept the farmer, his wife, eight children, and a female servant!! In answer to my enquiry, why they did not sleep in

* All cultivators of plants, whether for sale or not, are here called amateurs.

the upper rooms, which, though very low, were still habitable, they said they wanted them for a granary and for the men-servants. After a plentiful breakfast on coffee, eggs, and wheaten bread (a luxury here, for rye is in general use), in the parlour, which also contained the spare bed, i. e. berth, and the best images of their patron saints, we visited the farm-yard, to look at the implements and stock. The ploughs and harrows were such as we find in Essex, among what are called old-fashion farmers, but much more clumsy; the gear and harness, instead of iron traces and leather thongs and straps, were of wood and ropes, and manufactured in a manner that would make one of our English ploughmen laugh, and exult in the superiority of old England. The horses were fat in the extreme, and the cows a fine short-horned breed in good condition; but the pigs, heaven save the mark! made me laugh heartily, in which the farmer most good-naturedly joined: and when I gravely told him they would form a valuable article of export to England; and then, in reply to his earnest interrogatories, "Why?" told him that they would supersede our most valuable breed of greyhounds, for the purpose of catching hares, he perfectly understood the joke, and enjoyed it much. A friend had imported some good bred English pigs, for the purpose of crossing and improving their breed; but the Flemish farmers did not like to spoil their long-legged ones, and would not listen to him; the sheep were also in wretched plight, badly bred, and toothless. The land was, however, of fine quality; I saw red clover (*Trifolium pratense*) drying for hay, tied in sheaves, the stems of which were more than 4 ft. long; horse beans still in full growth, being partly off bloom, 6 ft. to 7 ft. high; wheat and rye also very fine; but that beautiful crop, flax, gave me most pleasure. I have not seen it growing in England or Ireland; but some fields between Bruges and Ghent seemed exceedingly luxuriant, also more particularly one or two on the Oudenarde road from Ghent, some plants of which I measured, and found the stems from 3½ ft. to 4 ft. long: the flax, I had previously seen in France, was perhaps not more than from 1 ft. to 1½ ft.

After a survey of the crops on the farm, we returned, and saw the family at dinner; and here, again, the contrast with England was most striking: the children were dining on flour and water, a sort of thick gruel, potatoes, and salad; and when I asked the mistress where they procured their meat, she immediately said they never ate any but "swine's flesh," unless a sheep fell ill, and was obliged to be killed.

It appears, the farmers here, partly owing to two or three wet seasons, and a failure of crops, are badly off; being behind in rent, and, though not tithed or rated, being heavily taxed by the government and priests. I noticed a curious anomaly, in the farmer's wife wearing heavy gold cheek plates to her cap, though the children were in the coarsest clothes, with sabots, and no stockings.

After a pleasant voyage from Bruges on a fine canal, I reached Ghent, and paid an immediate visit to Van Cassel, the father of the Ghent nurserymen: I think he said he was ninety. He is still devoted to plants, and regularly takes in a few of the English periodical botanical works: he is a good Latinist and botanist, and has so much enthusiasm for plants, that I was delighted with him: he has a most valuable botanical and general library. Among many curiosities, he showed me a rare edition of the Bible (I think in French), in 8 vols, folio, with the most curious illustrations. His nursery consisted of but one acre, chiefly planted with roses and azaleas, the latter growing in the most superb style. His newest varieties of these were *Azalea lacticolor*, *A. mímica*, *A. pulcherrima*, and *A. spúria amábilis*, for which he asked the moderate price of from twenty to forty francs each!

From this I visited Verschaffelt's nursery, Rue Caverne, where I found the largest stock of *Cactus speciosíssima* I ever saw; the camellias were neatly arranged by the sides of the walks, and numbers were inarched; as were also the azaleas. M. Verschaffelt particularly recommended *Caméllia marmoràta*, and *C. coloràta*, which he said were "très-grandes:" the grave importance with which he eulogised these camellias, the first of which he priced at fifty francs, and the other he said was so rare that it was not for sale, and his enthusiasm, made him with me a very amusing personage.

At M. Hellebuyck's nursery, I was much gratified with his magnificent plants of hybrid azaleas, generally inarched (called here "plaqué"). They seem to grow from seed with as much facility as the common pansy with us, coming up spontaneously in the borders. His camellias were in a reed enclosure, so neatly arranged in rows, and inarched in such a business-like and ingenious manner, all in the open air, that, so far from desiring it to be a hidden operation, as it generally is with us, they formed a very gratifying spectacle; the stages on which the pots with the stocks were placed were very cleverly arranged, and showed that extreme attention to minutiae which we are so apt to forget.

At Van Damme's, the lion was *Magnòlia máxima*, which seemed a variety of *M. acuminàta*, with rather a broad leaf.

I found from him that, instead of using the muscle stock for peaches, nectarines, and apricots, they always bud on "la prune mirabelle." The soil generally, in this part of Flanders, appeared unfit for peaches, &c., owing to its extreme lightness; but as they do better on this stock than on any other, and I thought this a hint which some of our light gravelly land districts might profit by, I have imported some of the stocks this season for trial. Upon calling at M. Lanckman's, he was urgent for me to purchase three new "*grandes*" camellias, viz. "*Impératrice*," "*Duchesse de Parma*," and "*Giema belgica*," 130 francs the three; his fertile description, in French phrases, would have given me a high idea, had not a friend at my elbow, used to their high-sounding terms, previously told me to listen, but not always to believe: therefore, with all due courtesy, I told him that one day I should come and see them in bloom, and then buy if they pleased me.

After visiting several other nurseries, we adjourned to the prince of the Ghent "*pépiniéristes*," M. Buyck Vander Marsh. What was to me most amusing in these calls was, that all I called upon doffed their sabots and working-dress, made themselves smart, and then joined me in my visits to the other nurseries without the least jealousy; though, of course, all were equally anxious to sell their own goods. M. Buyck Vander Marsh was, as the others had told me, a first-rate amateur, and knew all the novelties among plants well: he told me he was in communication with Messrs. Loddiges and Monsieur "Neet." Who this well-known English nurseryman was, for a long time I could not tell; at last Mr. Knight's name came to my relief, and after modifying the pronunciation gradually, so as to make "Neet," Knight, I made him comprehend that the name in English was what I pronounced. After looking over his rarities, of which he had not a few for so small a garden (about the third of an acre); I noticed *Magnolia* "*speciosa*," "*M. Alexandrina*," and a collection of *Rosa indica*, among which he named *Rosa strómbio vèra* as very fine, also the Lafayette rose.

Our party, which had increased to several, all florists and enthusiasts, adjourned to a tavern; and, when the wine had warmed their fancies, never did I see such a scene. Most of them spoke French, some a little English, and at times all Flemish; the praise of favourite plants, and urgent enquiries after novelties, were the themes. I should have liked Mr. Loudon to have been a looker on, and to have heard some of the many pleasant extravagances uttered respecting plants. I was astonished at the number of nurseries in this town; the population is, I think, not more than 90,000, yet I visited twenty

nurseries, all containing more or less what we call "good things:" they told me Germany was their principal mart, and the support of their trade. Almost all had one or two pretty good green-houses. A few were built in the manner of those in the London nurseries; these were pointed out to me by the owners with pride, as in "la manière Anglaise." The proprietors of these nurseries seemed generally very industrious; they were all clad in their working-dresses, with sabots and no stockings, and dining, as I more than once witnessed, on coffee, rye bread, and butter, they gave me no very high idea of their wealth, though I afterwards understood that these appearances were more owing to economy than poverty.

Before I leave Ghent, I must mention the botanic garden, which is open to the public as a promenade, and contains some fine specimens of the following hardy plants: — *Celtis cordata*, *Magnolia auriculata*, *Quercus Phellos*, *Gymnocladus canadensis*, *Larix péndula*, *Robinia viscosa*. Several of the finest exotics in boxes, placed in different parts of the gardens, were dedicated to botanists of eminence. Some venerable bays, from 8 to 9 ft. high, in boxes and pots, so old that their stems were hollow; also some old myrtles and oranges, all shorn into ball-like heads and naked stems, attracted my notice. For a botanic garden the collection was meagre, and the herbaceous borders were very bare; of many genera not a single species existed. There were numerous promenaders, who seemed to enjoy the garden, and carefully to abstain from injuring the plants.

I must be allowed here to introduce something not particularly appertaining to gardens and gardening; viz., that pretty assemblage of the sweetest whitewashed cottages, with green window-shutters and neat gardens, I ever saw, the "Béguinage." Sterne's tale of the "Fair Béguin" came forcibly to my memory, and made me enchanted with the spot and its associations.

In the market at Ghent I saw but few flowers or plants exposed for sale, and nothing among vegetables deserving particular notice; but some baskets of fine apples in the fruit market merit a few words. At the table d'hôte at my hotel (de Vienne), I saw every day a few plates of these apples, quite flat, and streaked with red, which were preferred to the strawberries and cherries; surprised at this, I tasted them, and found them delicious, quite plump, juicy, and fine-flavoured. They were called the Cour pendu.*

* I think known in England as the Court pendu plat.

Having exhausted my horticultural curiosity at Ghent, I took my departure for Brussels. The fine avenue of planes, sycamores, elms, &c., made travelling delightful; but nothing remarkable in the crops occurred till we reached Alost, near which place are grown large quantities of hops and onions. It is said that so many of the latter are grown, that the air is imbued with the smell; however, this season (July, 1830) they have totally failed: a small worm had attacked both the young onions and those for seed, and totally destroyed most of the crops. At Brussels my first visit was to the botanic garden, though quite by chance; for, as I was walking in the Boulevards, I was delighted with the view of a most magnificent garden; thinking it must belong to royalty, I enquired how I could gain admittance, and was soon informed it was the Jardin des Plantes, and open to all. I was surprised and delighted; for never had I seen so beautiful a public garden, the situation so commanding, the prospect of the distant country so fine, and its noble plant-houses so well arranged.

[A view of the Brussels Botanic Garden is given Vol. V. p. 327.; and our correspondent, C. Rauch of Vienna, now in the Chiswick Garden, has obligingly lent us plans (figs. 69, 70.) of the garden and hot-houses.]

They had here fine healthy specimens of most of the rare stove plants, in excellent condition: — *Crinum pedunculatum* and *C. amabile* were superb plants; *Yucca conspicua* was 12 ft. to 15 ft. high. The hardy department seemed rather in its infancy; the herbaceous plants were arranged after the Linnæan system, in beds diverging from a circle, each radiating bed being devoted to a class, and being subdivided transversely into smaller beds for the orders.*

Some of the Linnæan classes were very meagre, particularly Monadelphía and Polyadelphía. I did not observe any thing at all rare in this department, and in hardy shrubs the garden was still more deficient: but, considered generally, it is a most delightful spot, and, as a healthy promenade for the citizens, must be invaluable. A powerful steam-engine is at the lower part of the garden, near a piece of water, to raise it for a magnificent fountain. In the area in front of the range of houses, all was preparation for a grand musical festival, and exhibition of plants, to be held shortly; and a large circular room, behind the largest plant-house, was prepared with seats as an amphitheatre, in the centre of which prize plants were to be arranged, all in such fine taste and magnificence, that our

* This seems a very bad plan; for some classes have only two orders, and a dozen or two of hardy plants; while others have a dozen of orders, and several thousand plants. — *Cond.*

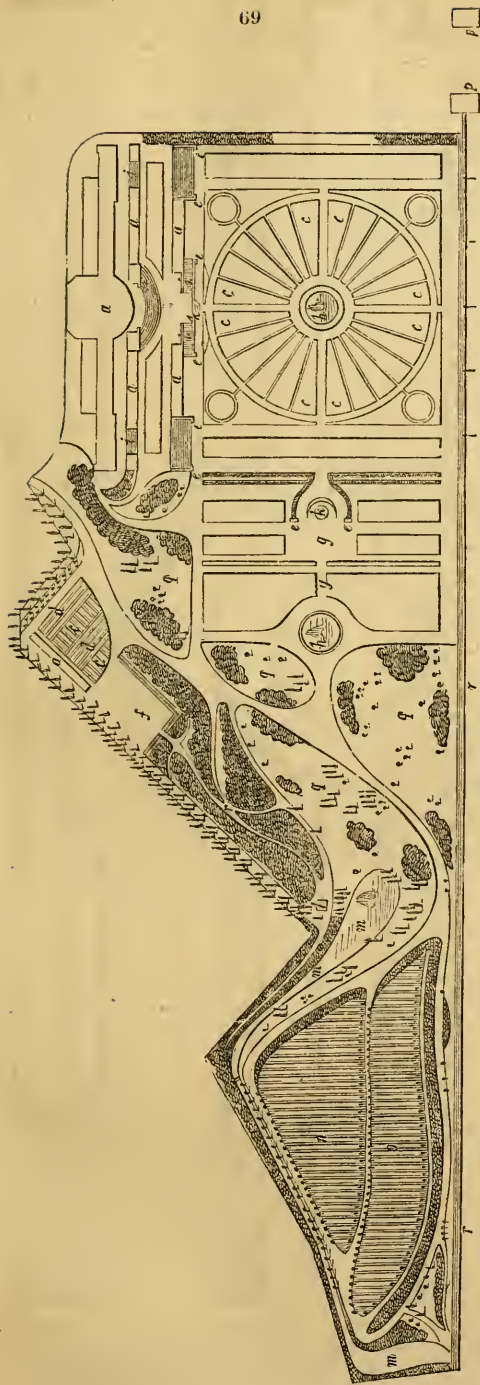

- a*, Hot-houses.
b, Botanic garden, or herbaceous arrangement.
c, Hot-beds and pits for forcing culinary vegetables, for propagation, and for raising seeds.
d, Experimental garden, from which the public is excluded.
e, Area for placing the plants of the orangeries and green-houses during summer.
f, Basins and fountains.
g, Stairs.
h, Nursery for trees and shrubs.
i, Large basin, or lake.
j, Gate of the city.
k, House for steam-engine, for supplying the fountains *k* and *h*.
l, Arrangement of culinary vegetables.
m, Small basins and fountains.
n, Nursery for fruit trees.
o, Statues.
p, Boulevards overlooking the garden.

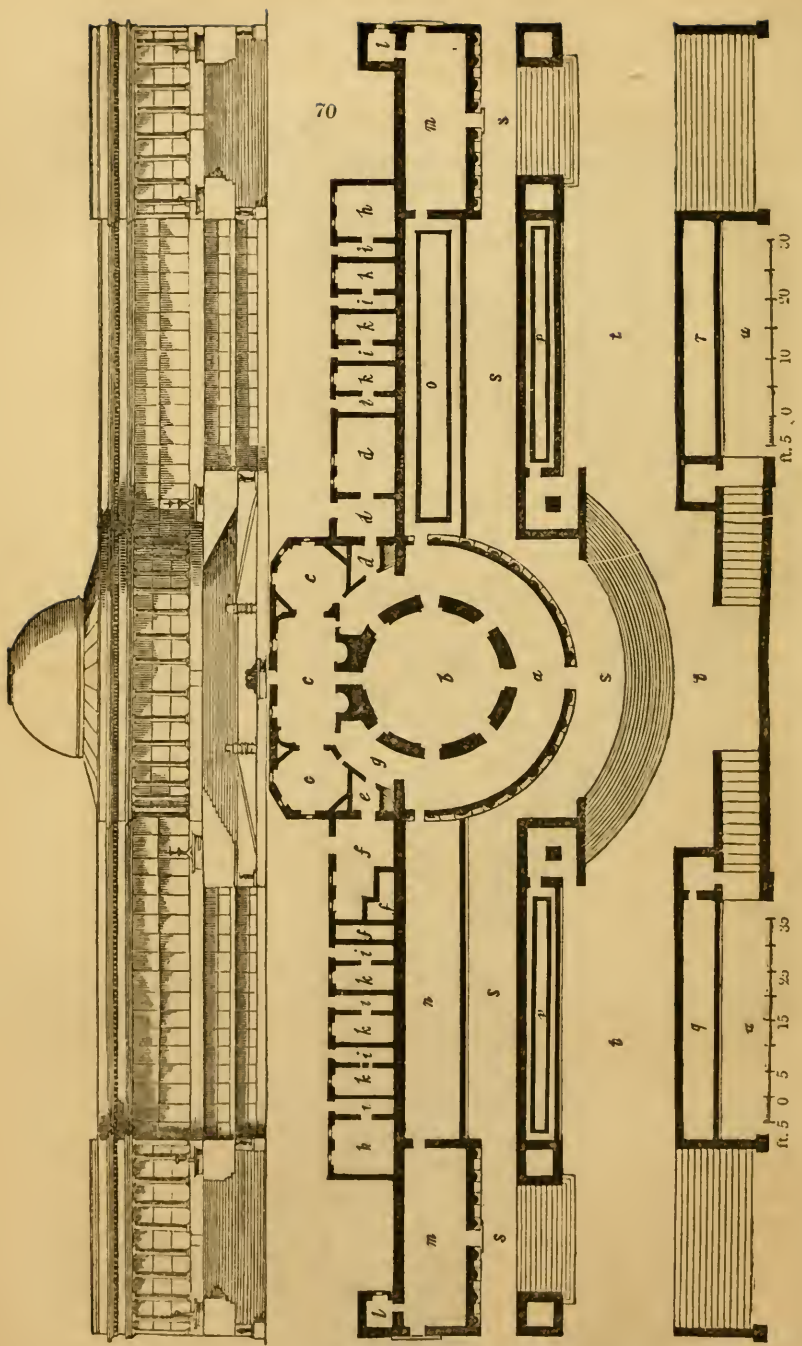

- 4, Tea-house.
- 5, Exhibition-room.
- 6, Coffee-house, library, billiard-room, and reading-room.
- 7, Rooms for receiving and preparing articles for exhibition.
- 8, Ante-room, or bar of the coffee-house keeper.
- 9, Kitchen and cellarage.
- 10, Passages.
- 11, Seats for garden.
- 12, Furnace and fuel shed.
- 13, Potting house, tool-house, and seed-room.
- 14, Seed-rooms, furnaces, and potting-sheds.
- 15, Orangery.
- 16, Glass-house.
- 17, Bark-store.
- 18, Pine-pits.
- 19, Propagating-pit.
- 20, Succession pine-pit.
- 21, Upper terrace.
- 22, Lower terrace.
- 23, Common surface of the garden.

ft. 5 0 10 20 30

ft. 5 0 5 15 25 35

horticultural shows seemed to shrink into insignificance before it.

At the flower market at Brussels some pretty standard *Cytisus nigricans* in pots, *Punica nana*, and oranges were exposed for sale. Of flowers, I saw nothing worth my notice.

I visited several nurseries, and found most of them in the Rue de Capucin, but of very small extent, perhaps from a quarter to half an acre. The plants they cultivated were principally the dwarf pomegranates (*Punica nana*), camellias, oranges, neriums (of which they say they have 20 varieties), *Jasminum odoratissimum*, bays, and laurustinus, all in pots; the last with pruned heads. The nurserymen at Brussels seemed much behind those of Ghent, both as to knowledge of plants, and in the value of their stock. I did not hear of any novelties; and their plants, I suppose, were generally of that description required at the Catholic fêtes, &c. All the vegetables I saw exposed in the different markets were most decidedly inferior to what are sold in the English markets: they did not seem to have had that care and capital devoted to them, which almost every one who cultivates them in England bestows.* I must now conclude these hasty and imperfect notes, and I really have written much more than I intended, at the risk, if you insert and they read, of sending some of my brothers of the pruning-knife to sleep. Some other winter evening, I may perhaps give them another composing draught on the subject, in a neighbouring country.

I am, Sir, yours, &c.

February, 1832.

T. RIVERS, JUN.

ART. III. *Investigation of the Structure of the Balsam (Balsamina hortensis Desportes)*. By the Author of the "Domestic Gardener's Manual."

Sir,

IN my former paper (p. 142.) I suggested that, if we hoped to ascertain beyond a doubt the precise channels of the vegetable currents, we must operate upon living subjects; and I proposed to inspect, microscopically, the stems of young balsams, whose roots had been either immersed in, or regularly watered with, coloured infusions. That I might leave nothing undone which could tend to assist in an enquiry

* It will give an idea of the severity of the winters, when I say, that in Vertenven's nursery were some very large old mulberries, with all their principal branches killed by the previous winter.

that I myself had proposed to others, I determined to commence several experiments; and the detail of two of these, with their results, will form the subject of the present communication.

A few fine seeds of the balsam, which had been ripened at Madras in 1830, were sown early in March last, and kept in a pine-stove during the course of their growth. Two of them, about 2 in. in the clear stem, were selected: one of these was pale, the other was tinged with red; they were planted in separate small pots, in light soil, composed of heath mould and decayed leaves chiefly. The plant with the pale stem was watered almost entirely with a strong solution of logwood; but it received, two or three times, a slight refreshment of pure water, when, by oversight, and the great heat of the house (occasionally above 100°), the soil had become quite dry. During three weeks that I carried on this process, the plant, although it lived and stood erect as long as the soil was in a moist state, made little or no progress in growth. I mention this fact, because it shows that watery coloured infusions, though highly impregnated with carbonaceous matter (and therefore, as might be supposed, abounding with vegetable aliment), furnish, in reality, no appropriate food to some plants; to the balsam in particular.

The other plant, that with the red stem, was supplied with pure water only, for about a fortnight; and it grew much better than the one that was treated with the infusion. It now was taken up, its root cleansed from the soil, and placed in a glass vessel, containing a deeply coloured infusion of logwood. Both the plants were kept in the stove, and there they remained for another week; at the end of which they were carefully investigated.

1st, The plant with the white stem, the soil of which had been watered with the infusion, was removed from the pot, and its roots washed; it was then supported by tweezers, so as not to injure it, and its stem was examined by the microscope, under every situation, with respect to light, that could be commanded. Not a particle of colouring matter could be discerned under the cuticle (epidermis), and even when a portion of that exterior integument was removed, there was not the least discoverable appearance of colour among the exposed cells. A small strip was next cut with a lancet along the stem, so as to discover and detach some of the longitudinal vessels. I mean those which were formerly believed to be the tubular sap-conduits, whether, in their texture and condition, they be spiral, annular, reticulated, or punctuated; and which corresponded with the tracheæ, small and mixed tubes

of Grew, Mirbel, and others. The wounded surface of the stem, as well as that of the detached strip, was examined with and without immersion in water; still, not a tint of colour was afforded; nor could any be obtained on inspecting a small slice cut horizontally across the stem.

2d, The plant with the red stem, which had grown in the coloured infusion, was next investigated; but it was void of tint in any part of its organisation, except on the epidermis. Hereon, indeed, a most interesting spectacle was exhibited; for the natural colouring matter which afforded the red tint to the skin, was found to be deposited in the most fanciful and beautiful forms imaginable. As a splendid object, when viewed under every different degree of light, from complete shade to the glare of full and condensed sunshine, I cannot conceive one that can surpass it; and I earnestly recommend your readers who possess, or can command the use of, good microscopes, to devote strict attention to a careful observance of so wonderful a combination of colours. As far as my testimony may go, it can be compared only to a tissue, or network, composed of threads of brilliant crimson foil, fancifully and irregularly spread over a surface of glittering and greenish silver.

To return from this digression to the subject of my communication: I have already observed that the examination detected no traces of the colouring matter of the logwood in any part of the subjects investigated; consequently, no light has been thrown, by these experiments, upon the mystery which involves the enquiry concerning the proper channels of the two saps. Sir H. Davy observes, in his sixth agricultural lecture (*Lectures on Agricultural Chemistry*, edit. 1827, p. 243.), that "the pores in the fibres of the roots of plants are so small, that it is with difficulty they can be discovered by the microscope; it is not, therefore, probable, that substances can pass into them from the soil. I tried an experiment on this subject. Some impalpable powdered charcoal, procured by washing gunpowder, and dissipating the sulphur by heat, was placed in a phial containing pure water, in which a plant of peppermint was growing; the roots of the plant were pretty generally in contact with the charcoal. The experiment was made in the beginning of May, 1805; the growth of the plant was very vigorous during a fortnight, when it was taken out of the phial: the roots were cut through in different parts, but no carbonaceous matter could be discovered in them, nor were the smallest fibrils blackened by charcoal, though this must have been the case had the charcoal been absorbed in a solid form."

From the foregoing experiment of Sir H. Davy, we may conclude that the most impalpable powders can by no means be taken up by the vascular absorbents of plants; and my own observations upon the two balsams lead to the conclusion, that colouring matter, even in a state of solution, cannot be introduced to the vegetable vessels through the spongioles or porous fibrils of the roots. These consentient evidences tend to throw considerable doubt upon the justness of those deductions that have been drawn from observing traces of colour within cuttings of plants, and young stems or twigs, that had been immersed in coloured infusions of any kind. Cuttings and slips are merely mutilated portions of the subjects from which they have been detached. They retain, it is true, a vestige of the vital principle; but that lies dormant, and would soon become extinct, were it not excited, and brought into activity, by the stimulus of some appropriate medium, into which, when so placed, other circumstances being propitious, it may protrude roots.

Though no positive evidence of the exact nature or site of the vessels of conduction has been afforded by my experiments, they have tended to confirm the ideas I had previously formed. In the first place, the cells, those little vesicles or bladders which constitute the pulp of the stem, were replete with fluid: hence, if not conductors, they are at least depositories of the vegetable juices. Again, the fibrous organs (that is, those bundles of more opaque tubes which pass longitudinally along the whole stem, and give out branches to the leaves and leaflets) seemed to be dry; no vestige of fluid appeared to be in them, as a passing current; if any were discernible, it seemed to have been let or forced in by the violence of the dissection. The fibrous texture, and prodigious elasticity, also, of the organs, demonstrate that they are in every way better adapted to regulate and support the varied motion of the plant, than to act as conductors of its fluids. However, I shall not enlarge further at this time, but content myself with observing, that the fibrous organs of the balsams I examined appeared to me to be placed not far within the epidermis, in small equidistant bundles, and to consist almost entirely of purely spiral fibres, of those more compound organs that have, by some, been styled annular vessels, from the circumstance of their being constructed of a simple membranous tube, distended by rings, which rings are separated from one another by a space little exceeding their own breadth. These spaces are discernible by a microscopic power not exceeding one hundred and fifty times. I designate all these appendages to the true sap-vessels fibrous organs; and I

conceive that the old term tracheæ (windpipes) is much more expressive of their nature and offices, than the modern appellation of conducting vessels. In fact they may, and probably do, convey air to the internal parts of the whole plant; but the functions which they are chiefly intended to perform appear decidedly to be those of mechanical action and reaction: perhaps, also, they may be employed as conductors and distributors of the electric fluid; for, as every part of the plant, to the remotest termination of its leaves and flowers, is more or less furnished with these fibrous organs, it is not unreasonable to suppose that they are the channels of those ethereal currents, which perhaps primarily sustain, if they do not actually constitute, the principle of vegetable life.

June 15. 1832.

G. J. T.

ART. IV. *Description of a Design made for the Birmingham Horticultural Society, for laying out a Botanical Horticultural Garden, adapted to a particular Situation.* By the CONDUCTOR.

BEFORE describing this design it will be proper to state shortly, the nature of the situation, the wishes of the Birmingham Horticultural Society, and the other given data on which it was composed.

The situation is at Edgbaston, about two miles to the S. W. from what is esteemed the centre of Birmingham; the extent is considered to be about sixteen acres, the form of which is irregular; and the surface consists of about an acre, nearly level at one corner, from which the ground spreads out like a fan, in a steep and varied slope; the lower boundary being upwards of 60 ft. below the entrance of the garden. This will be easily understood by a glance at the plan, *fig.* 71., and the section A B. The aspect of this slope is to the S. W. and S. E. The soil is singularly advantageous: the greater part is a sandy loam; but there is an acre of peat, and three acres of good medium loam. It is highly probable that there is also gravel at a short distance beneath the surface. There are two perpetual springs in the ground, and a small water-course forms a part of the boundary.

The committee, in mentioning to us the objects they had in view, stated that they wished to combine a scientific with an ornamental garden; and these, to a certain extent, with a nursery and market-garden; so as, by selling superfluous plants, fruits, and culinary vegetables, to lessen the annual expense of keeping. It was further stated, that, whatever plan might be adopted, it could only be executed by degrees; as

the funds available for that purpose did not then exceed three thousand pounds, though a considerable addition to this sum was expected to be obtained, when the garden should be commenced, and the public had an opportunity of inspecting it.

With these data and desiderata, we set about devising a suitable design. The first point which we determined on, was that of surrounding the whole sixteen acres with a holly hedge, to be planted immediately within the existing boundary fence of hawthorn: being convinced that, if the ground in the line of the hedge, were trenched and manured, in order to increase the growth of the plants, the holly, in the given soil, situation, and climate, would produce leading shoots, averaging 12 or 14 in. a year for several years. The next point which we determined on was, to place the hot-houses on the level area which forms the highest part of the surface. As the entrance to the garden must necessarily be from the only road which passes it, and that road is on the north side, it follows, that, if the hot-houses were built in the usual manner against a wall, they would be approached from behind, and the first object that met the eye would be the back sheds: this is the case in the Liverpool Garden, and must necessarily be so in all gardens in which the hot-houses are placed near the main entrance, without there being a space sufficiently ample to admit of making a circuitous approach to their front. As there is neither an ample space in the case of the Birmingham garden, nor a fitting situation for the hot-houses any where else in the given area, than this, which is close on what must necessarily be the main entrance, we determined to form these hot-houses on a circular ground plan, because it is the only one calculated to look equally well on all sides.

A fourth point necessarily resulting from the shape and slope of the grounds, was the zigzag direction of the main walks; in order to descend with ease from the high to the low grounds, and to ascend in like manner from the latter to the former. This point determined on, led to another; viz., the distribution of the arboretum around and through the garden, along one side of the main walk, instead of around the garden only, as is most frequently the case.

These leading features being determined on, we made out the details of what the garden should be, when finally completed, as exhibited in *fig. 72*.

But as, from various economical reasons, the garden could only be completed by degrees; and as some parts of our plan might, from the expense required, never be executed at all, we so contrived all the expensive parts of the details, as to allow them to be omitted, or have others substituted for them

of a more economical character. The garden was thus constructed, that it might, from the beginning, and at all times during the progress of our plan, form a whole, which, though not so perfect as it is contemplated finally to be, would still be complete and perfect in its kind. How this is to be effected will best be shown by describing the working-plan and section, *fig. 71.*; the vertical profile, *fig. 72.*; the plans of part of the arboretum, *figs. 73. and 74.*; and the plans, sections, and elevations of the hot-houses, *figs. 75, 76, 77, and 78.*

Fig. 71. Working-plan for the general distribution of the Birmingham Botanic Garden. The contents of the whole are thus disposed of: — Botanic garden, (1) 7 acres; pleasure-grounds (κ), $2\frac{1}{2}$ acres; American garden, (L) $\frac{3}{4}$ of an acre; flower-garden (M), $\frac{1}{4}$ of an acre; orchard and fruit-tree nursery (N), $1\frac{1}{2}$ acre; kitchen-garden and agricultural ground (O), 2 acres; reserve garden and experimental ground (P), $\frac{1}{4}$ of an acre; space on which the hot-houses stand, gravel walks, &c., $1\frac{5}{8}$ acres: in all, 16 acres.

The section A B, taken on the line A B in the plan, shows the inclination of the surface in the plan. In this section are seen the entrance lodge, 1; circular clump of variegated hollies, 2; hot-houses, 3; tower, with steam or hot water apparatus under, water cistern over, and surrounding underground carriage way, 4; basins, with jets of water, 5, 6, 7; large basin, and grand jet at the bottom of the garden, 8; overshot water wheel, supplied by a pipe from 7, for raising water to the cistern in the tower, 9; and water-closets, 10.

The details of *fig. 71.* are as follow: —

- A, Main entrance from Birmingham.
- B, C, D, Lower parts of the grounds: the fall from A to B is nearly 70 ft; from B to C the rise is about 10 ft.; from B to D the fall is about 3 ft.
- E, Circular range of glass; the darkest shaded part, viz., the entire outer circle of pits, and one hot-house, and a green-house, being that which is proposed to be first executed.
- F, House and offices now existing, and proposed to be retained for the use of the curator, the council, &c.
- G H, A tunnel for communicating by carts, &c., between the road and the engine for heating the hot-houses, and also with the curator's house and offices.
- 1, Botanic garden. The general surface is turf, on which the herbaceous plants are placed in dug groups, for the most part circular, and limited to one genus each; and the ligneous plants are planted singly on the turf, with the exception of the lowest of the under-shrubs; which, like the herbaceous plants, are placed in dug groups. The finer varieties of roses, azaleas, and some other shrubs, are not understood to be included in this collection, but only the species and more hardy varieties.
- κ, Pleasure-ground; consisting of lawn varied with groups of the most ornamental flowers and shrubs, with some trees; including a rosary, an open alcove or covered seat, and a variety of sculptural and architectural ornaments. On this lawn various structures for birds, monkeys,

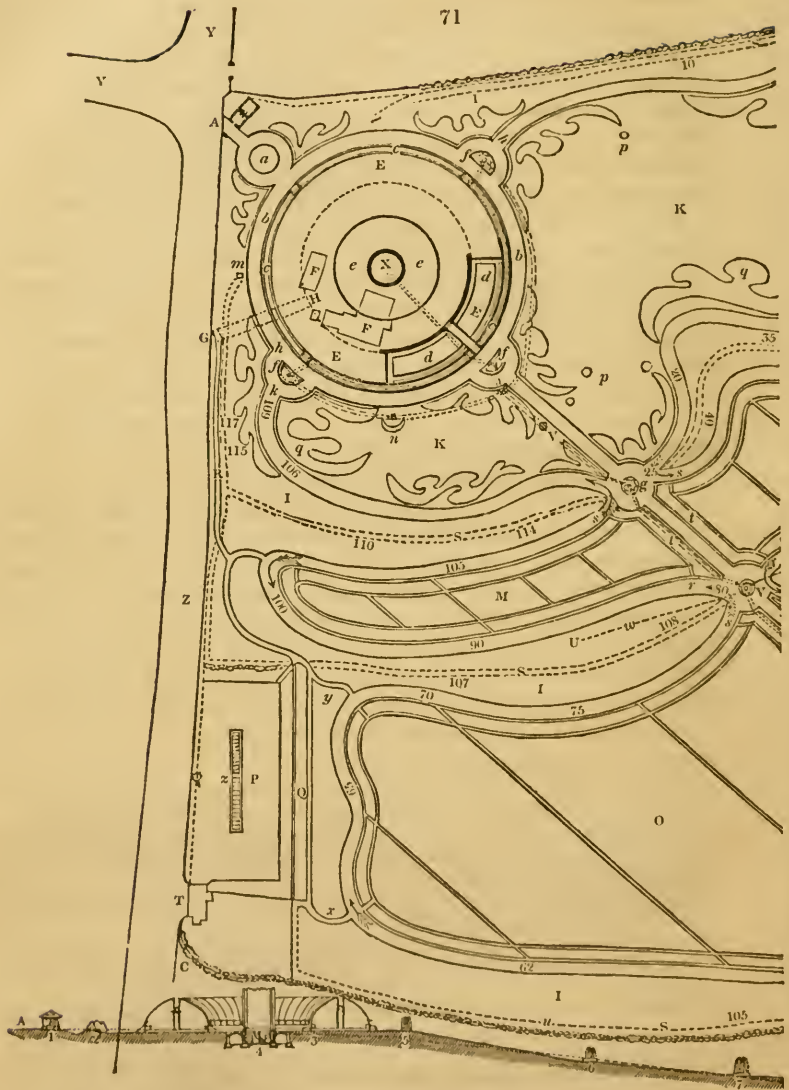

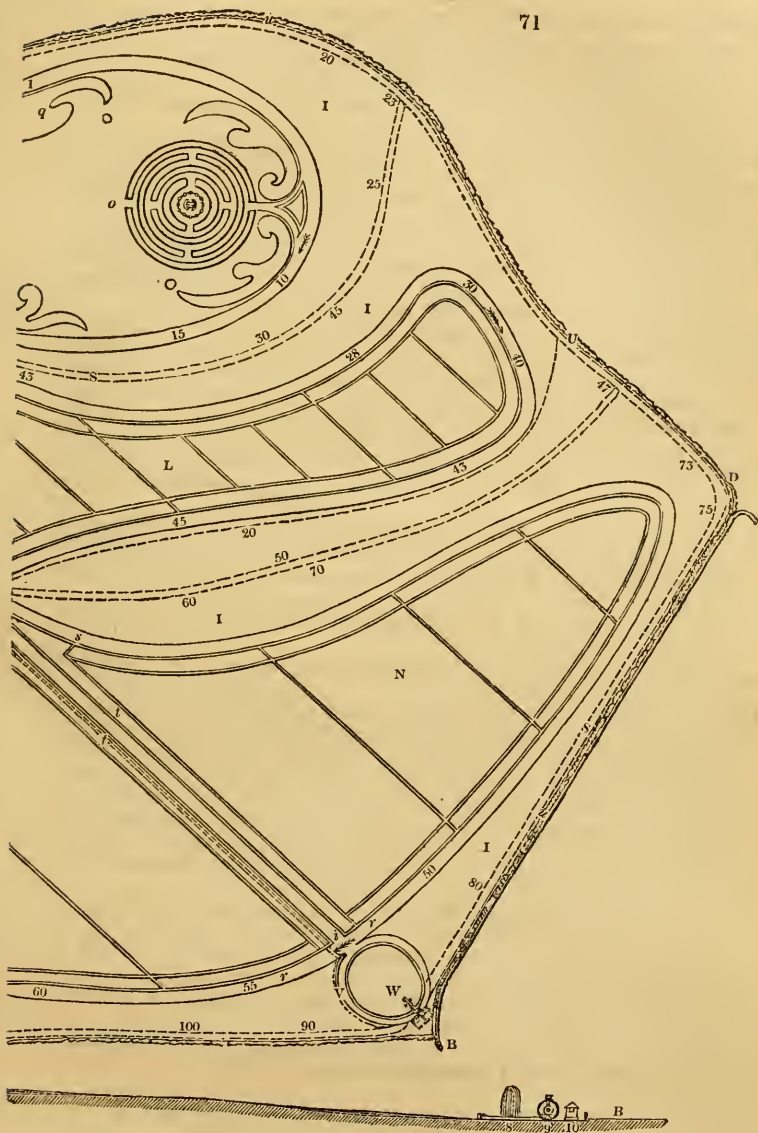

In this plan, reduced from one three times its size, it has been found impossible to get in all the figures representing the different orders and tribes of trees and herbaceous plants, as they are to stand in the botanic ground. See the references to *h* and *l*, in p. 413.

- and other animals, might be introduced, should it ever be deemed advisable to combine a zoological establishment with this garden.
- L**, American garden. The surrounding border is for a collection of single specimens of American and other peat-earth shrubs, trees, and herbaceous plants, and the interior compartments are for propagating plants for sale.
- M**, Flower-garden. The surrounding border for a collection of single specimens of roses, dwarfs, and standards, and of the most showy common garden-soil border flowers; the interior for bulbs and other florists' flowers, georginas, stocks, &c., and other annuals for sale.
- N**, Orchard. The surrounding border, and the margins of the alleys, for a complete collection of single specimens of fruit trees and fruit shrubs; and the interior for propagating them for sale. Among the specimens in the border may be interspersed the collection of strawberries.
- O**, Kitchen-garden. The surrounding border for single specimens, or small beds of every kind of culinary vegetables, and herbaceous fruit plants, such as gourds, &c., annual or perennial, grown in kitchen-gardens, and the interior for propagating them for sale. The plants of agriculture and arboriculture, not grown in gardens and parks, will occur in the botanic garden; but if it should be thought fit to exhibit these collected together, more especially the different varieties of corns and cultivated grasses, that may be done in one of the compartments of the kitchen-garden.
- P**, Experimental and seed garden, into which the public are not admitted. In this is a range of pits or frames, for raising seeds and annuals for transplantation into the borders; the composts and manures are also kept in this garden.
- Q**, Hollow wall, for being heated by hot water, for the growth of peach trees, nectarines, figs, &c.
- R**, Gravelled walk from the forcing garden to the tunnel, so as to connect it with the hot-houses.
- S**, Dotted lines, including between them a space which is not to be planted on, in order to admit of walking through the botanic garden, and consequently round the whole garden, on turf, for those who may prefer a grass walk to one of gravel. These dotted lines, it must be recollected, are entirely imaginary; and, in reality, the glade of turf will have a most irregular boundary, formed by the ever-varying position of the trees of the arboretum. The use of the lines on paper is to show that, in planting, the space between them must on no account be encroached on from either side.
- T**, Cottage already existing, which may either be let, or occupied by the curator's foreman, and the workmen and apprentices under him.
- U U**, Situation of two perpetual springs, the water supplied by which it is proposed to collect in the basin **v**, and thence to convey it to an over-shot wheel at **w**, which works a forcing-pump, for the purpose of raising the water to the cistern in the tower **x**.
- X**, This tower supplies water to the hot-houses, and to all the fountains.
- Y Y**, The two roads from Birmingham to the garden gate.
- Z**, Road to Harborne.
- a**, Mass of variegated hollies, shown in the section **λ n** at **l**.
- b**, Circular terrace walk on a perfect level, and 12 ft. broad.
- c c c**, Circle of pits to be immediately erected, and backed by a temporary fence of pales or brick, of the exact height of the front glass of the hot-house and green-house, **d d**, as in *fig. 77*. Within this wall a border may be formed, for fruit trees to be trained on it; and, by leaving holes through the wall, immediately over the upper part of the pit, the stems of ornamental shrubs planted in the border behind may be brought through

these holes, and their branches trained on the outside; thus covering the wall, so as to render it both ornamental and useful. These pits may be used for any or all of the purposes for which hot-houses are erected; because, the soil being perfectly dry, they may be made of any depth. We propose using them in four divisions: one for hot-house plants in pots; one for green-house plants in pots; one for a collection of pine-apples; and one for forcing fruits and culinary vegetables in pots, such as cherries, peaches, strawberries, figs, vines, kidneybeans, &c. In summer, when the green-house plants are placed out of doors, their place may be supplied by melons, and melons may also occupy the forcing department. To save labour, however, in the case of the green-house plants, the sashes may be removed, and the plants exposed to the weather as they stand in the pit.

d d, Hot-house and green-house, proposed to be first erected. The back wall may be of bricks, set in clay instead of lime mortar; in order that it may be easily taken down, and the bricks readily cleaned. It may be whitewashed inside, and covered with a trellis for creeping plants, &c. It is intended that the outer circle of hot-houses, as far inwards as this wall, shall be completed, before any part of the inner circle is commenced; still the whole will be complete, as far as it goes.

e e, Area, in which the green-house plants in pots may be placed during the summer season.

f f f, Semicircular basins, with jets in the centre, all on one level.

g, Circular basin, with a jet in the centre, on a level platform, 25 ft. lower than the level of the terrace walk, *b*. The fountain (*v*) is 15 ft. lower than *f*; and *w* is 20 ft. lower than *v*. The latter has a jet in the centre, which, when played from a pipe, communicates with the cistern *x*, and will raise the water to a maximum of height, according to the diameter of this jet.

h, Commencement of the main walk, having the arboretum and collection of herbaceous plants on the left hand, and the pleasure-ground on the right. On the walk (in this plan) are indicated in figures, the different orders which contain hardy herbaceous plants, and the spaces which it is calculated they will respectively occupy, when planted in groups limited to one genus in a group, in the manner to be hereafter described. The course in which this walk ought to be followed by the botanist, in order to take the different orders and tribes in their proper succession, is indicated by the direction of the arrows (\rightarrow). Whoever wishes to examine the whole of the plants and trees composing the botanical collection, in the order in which they are given in Part II. of our *Hortus Britannicus*, must not cross the straight north and south walk, except at *i*, in the bottom of the garden.

k, Termination of the natural arrangement.

l, Vase, indicating the commencement of a grass walk, or rather glade, through the arboretum, which, it will be observed, passes through and around the garden, till it regains the terrace walk at *m*. Along these dotted lines are marked the numbers of the natural orders, as given in the *Hortus Britannicus*, which contain hardy trees and shrubs, with the spaces they will occupy when planted according to a certain rule, which will be hereafter given.

n, Statue, or sculptural ornament, or sundial.

o, Rosary, with a covered seat in the centre.

p, Small circular groups, for tender annuals and tender plants in the summer season.

q, Groups of choice hardy perennial and annual plants, with roses and other shrubs, and some trees.

r, s, The extreme points of hedges of box placed for the purpose of sepa-

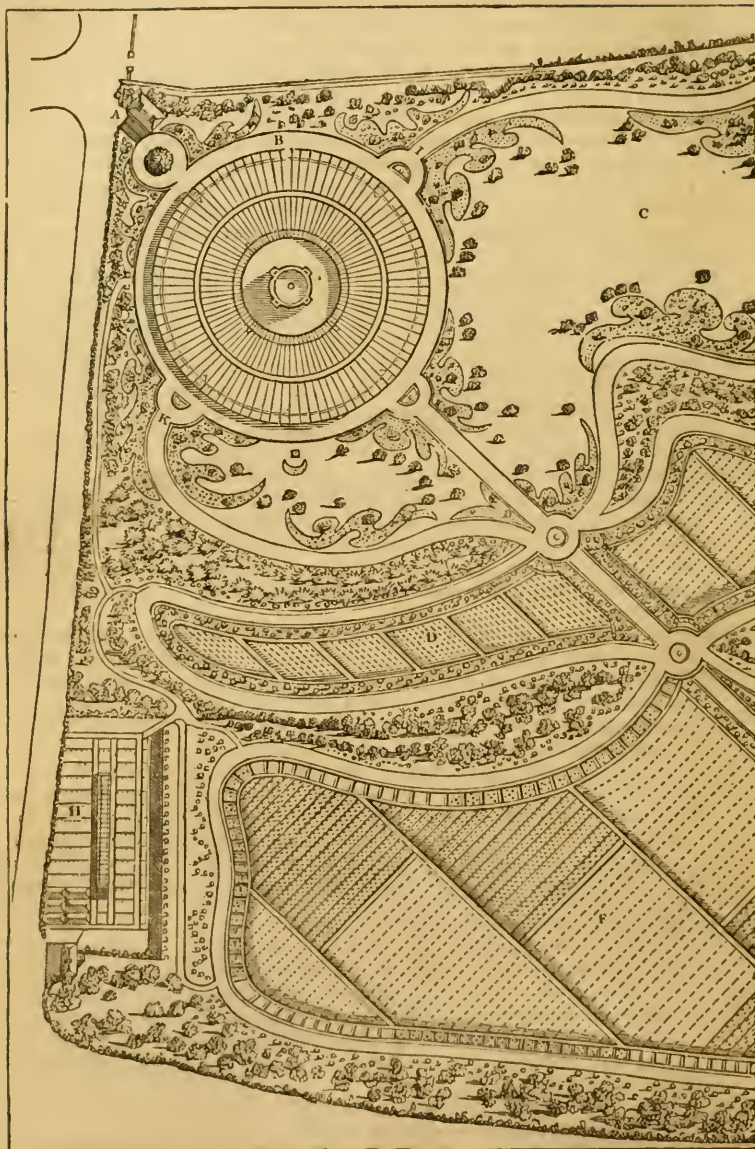

A, The main entrance.

n, Circular terrace walk surrounding the hot-houses.

C, Pleasure-ground.

D, Floricultural garden.

E, American garden.

F, Kitchen-garden, and agricultural garden.

G, Orchard.

H, Experimental garden.

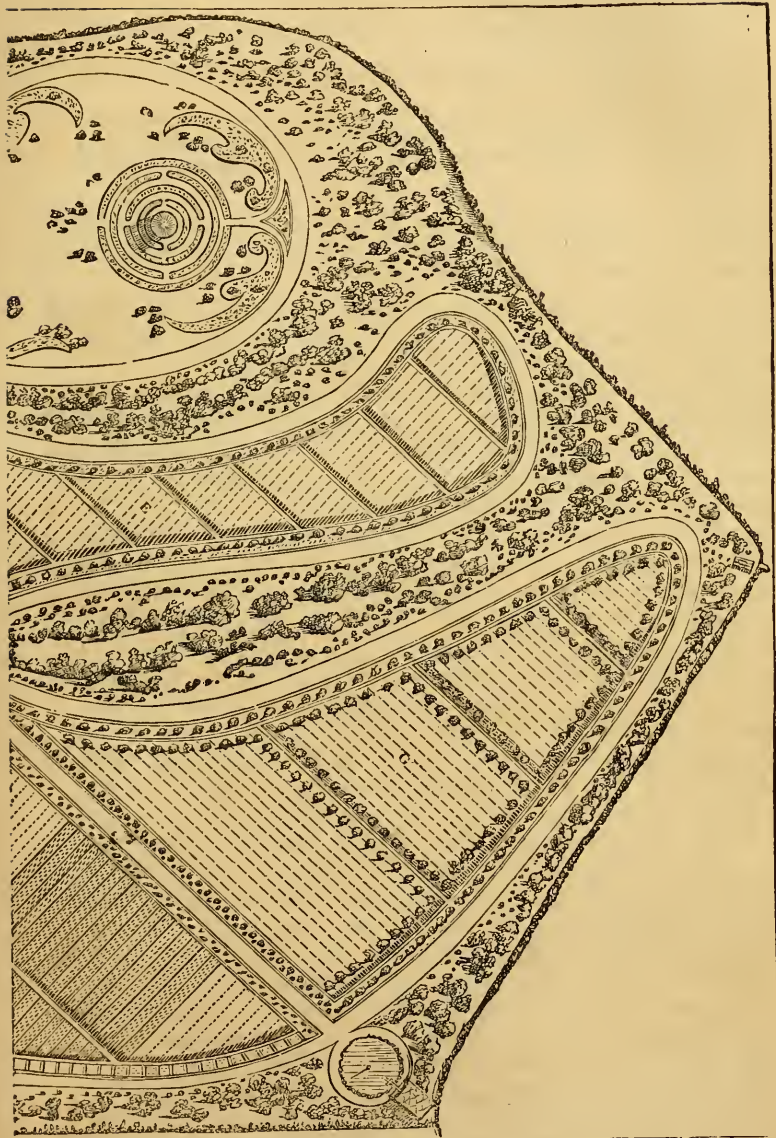

The remainder of the ground is occupied with the arboretum and the herbaceous arrangement, as before explained, commencing at 1, and ending at κ.

rating the borders (*t t*) from the orchard, the kitchen-garden, the American, and the florist's garden.

t t, Border of flowers arranged for a perpetual succession during the greater part of the year.

u, Dotted lines, representing the proposed holly hedge within the existing hawthorn hedge.

v, Double lines, dotted, representing the situation of the main pipes for conducting the water from the cistern *x* to the different fountains, and also of another pipe for conducting the water from the forcing-pump at *w* to *x*.

w w, Pipe-drains from the springs *u u* to *v*.

x y, Space in which the arboretum is omitted, in order not to shade the peach wall *q*; but in which the herbaceous arrangement is continued.

z, Pits or hot-beds in the experimental garden.

Fig. 72. is a vertical profile of the garden, on the supposition that all the hot-houses are executed, and that the trees and shrubs have had 10 or 12 years' growth.

Fig. 73. is a working-plan of a small portion of the botanical arrangement. In this plan, the situations for the herbaceous plants are shown chiefly as circles; each circle having marked beside it the number of the genus for which it is intended, agreeably to the enumeration of the *Hortus Britannicus*. The size of the circles is also proportioned to the number of hardy herbaceous plants given in that work; and, according to the calculation of the space dug, will occupy as indicated under each natural order in Part II. (See *Hort. Brit.*, Explanatory Introduction to the Natural Orders, p. 491.; and *Illustrations of Landscape-Gardening*, &c., Part II. plates vi. and vii.) The small crosses (X), with the numbers attached to them, show the positions of the trees and shrubs; the numbers indicating the species or variety in the *Hortus Britannicus*. The dotted lines, *a b*, are imaginary lines, to be drawn on the ground when planting, in order to preserve a clear space of the width of a walk, *c c*. The dotted lines, *d d*, are also imaginary; and must be drawn on the ground, when planting, to prevent any of the trees or shrubs from being planted within a certain distance (5 ft.) of the groups of herbaceous plants. It will be observed from the enumeration, that both herbaceous plants and trees proceed in the order indicated by the arrows; and that the herbaceous orders are distinct from those of trees: this being unavoidable, except in gardens many times the size of the botanic ground before us.

In executing this botanic ground, the first process is, to drain, level, trench, and smooth the surface. Then to put down the groups of herbaceous plants, none of them nearer to the walk than, say 3 ft., or nearer to each other than, say 2 ft.; always preserving 3 ft. between the last genus of one order or tribe, and the first genus of that which

follows. Where there is abundance of room, the groups may all be made circular, and may proceed in one line along the margin of the walk, their circumferences being all at one uniform distance from it, as in *fig. 74.*; but where the space is

74

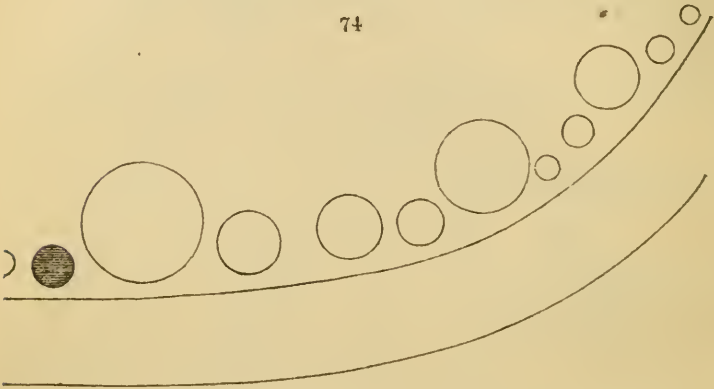

limited, the line for the small groups will require occasionally to be made circuitous, and the form of the large groups to be made irregular, or, at all events, of greater length than breadth, for the sake of adjusting the whole collection of plants to the extent of the ground and its outline. Thus, in *fig. 73.*, something is gained by the circuitous direction of the groups at *e*, and by making group *f* of an elongated shape; for, if group *f* had been made circular, it would have interfered with the continuity of the arboretum. The position of all the groups of herbaceous plants being fixed on, and their boundary lines being cut out with a spade, the dotted lines which bound the arboretum are then to be traced on the ground, according to the rule before mentioned; and the positions of the trees are to be found by the following rules. Keep within the boundary lines; let no tree or shrub be nearer another than 5 ft., and let every species be at least 2 ft. in advance of the other; that is, measuring on the lines *a b*. The reason for placing one tree, or shrub, somewhat in advance of the other, is, that a guide is thus given to the position of any species or variety which may come the next to any other species or variety; thus, if we have found *Carpinus* 28383, we know that the variety $\frac{28383}{2}$ will be in advance of the species to which it belongs; whereas, if we did not know this, we might be seeking it either on a line to the right or

left, or behind it. The advantage of these rules being acknowledged, the planter has only to make the most of his space, zigzagging the trees from one imaginary line to the other, but never going beyond either. As the positions of the trees and shrubs are found, a pin, or stake, having the number of the plant marked on it, should be driven in, there to remain till the plant is got, and a proper name and number affixed to it, either in Murray's manner (described Vol. III. p. 29.), or in that of Allardyce (p. 33.). The temporary numbers may be either notched on the stakes, or marked with a pencil on white lead rubbed on a part of the stake or pin, previously cut smooth with a knife. In the centre of every group intended for herbaceous plants, a numbered stake should also be put down; for which is afterwards to be substituted a tally, containing simply the name of the order or tribe, and its number; and the name of the genus for which the group is intended, with its number. Each species, as it is added, will only require the specific name, with or without the initial letter of the genus. It is almost unnecessary to mention, that, where groups of water plants occur in the herbaceous arrangement, small basins (*fig. 73. e e e,*) must be made for them, proportionate to the spaces which they will occupy, as indicated by figures in the *Hortus Britannicus*, and by circles in plate vii. of *Illustrations of Landscape-Gardening*. All the groups and basins for herbaceous plants being notched out, and stakes put in at the proper places for inserting all the trees and shrubs, the surface not occupied by the groups may next be sown with a proper mixture of grass seeds. (p. 176.)

As the plants and trees are introduced in their places, it will become necessary to introduce with them their appropriate soils; but this will not interfere with any of the foregoing operations: neither will the circumstance, that with some species of shrubs it may be necessary to prevent the grass from growing within a few inches of their stems; and with others, to place a bed of small stones round the stems, to prevent them from damping off with moisture.

Fig. 75. shows the plan, section, and elevation of the proposed circular range of hot-houses, the construction of which is so simple, that very little description is requisite. The ground plan (A B C) is exhibited in a dissected state; one part (A) showing the foundations; another part (B) representing the steam or hot-water pipes laid down; and the remaining part (C) exhibiting the beds as filled with earth, and the walks as completed with pavement or cast-iron grating. The details of this plan are as follow:—

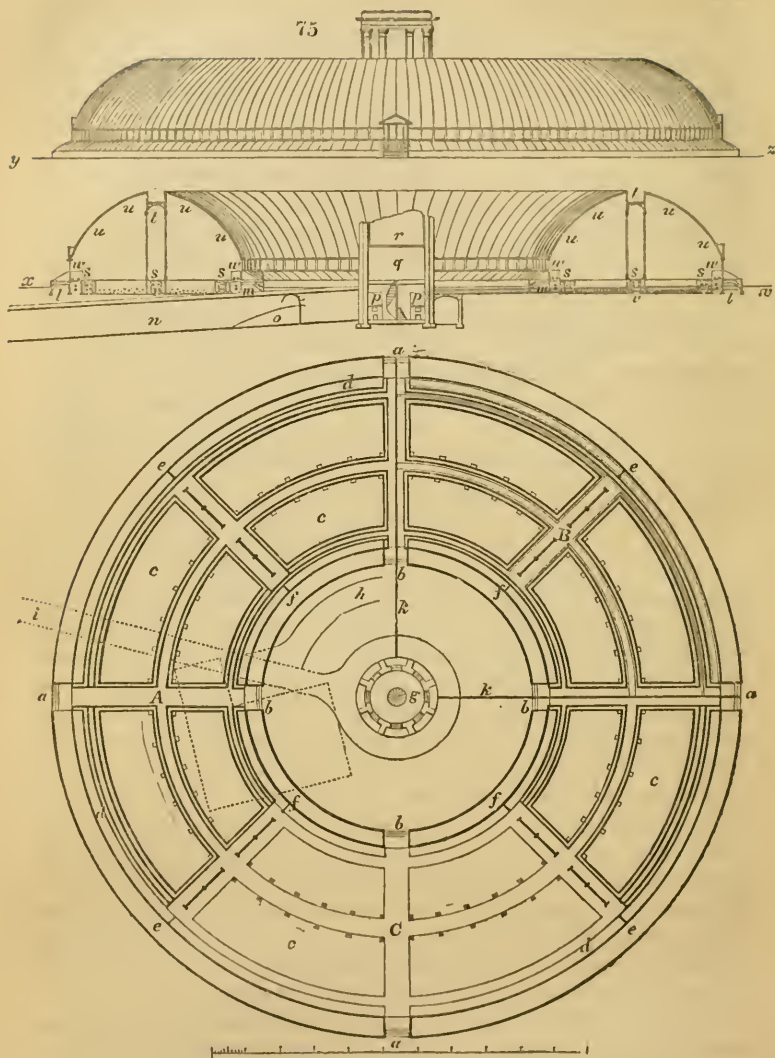

a a a a, The main entrances from the surrounding terrace.

b b b b, Corresponding entrances from the interior area.

c c c c, &c., Beds for large specimens to grow in the free soil.

d d d, &c., Shelves for plants in pots.

e e e e, The exterior pit, in four divisions.

f f f f, The interior pit, in four divisions.

g, Central tower, in which is contained the steam or hot-water apparatus in the cellar story, a potting-shed on the ground floor, and in the upper

part a supply cistern for the hot-houses and jets. Round the base there is a vaulted passage, by which carts may pass round, unless it is considered preferable to ascend the inclined plane *h*, and drop the coals, through man-holes on the surface, to the cellars below.

h, Inclined plane to the tunnel.

i, Tunnel, which communicates with the base of the tower, the interior area, and the public road.

k, Mains of the steam or hot-water apparatus.

The section, which is taken across an imaginary line from *i*, through *g* and *k*, to *a*, exhibits the following details:—

l l, Exterior pits. *n n*, Interior pits. *n*, Tunnel.

o, Archway, forming the entrance to the inclined plane which leads from the tunnel to the surface of the central area.

p p, Two steam or hot-water apparatus: either of these will supply heat to the whole range; but two are recommended, in case of accident.

q, Potting-shed. *r*, Cistern.

s s, Walks within the hot-houses.

t, Walk over them, in which, during winter, rolls of matting may be kept, for letting down over the glass to exclude the frost.

u u u u, Situation of pipes pierced with numerous small holes, for watering all the hot-houses, in imitation of a shower of rain, as at Messrs. Loddiges's.

v, Steam-pipes shown under the pathways.

w w w w, Benches for pots.

x x, Surface of the terrace walk.

y z, Elevation, taken opposite the centre of either of the four entrances.

The cheapest and best mode of heating these hot-houses, we think, will be by steam: cheapest, because, by this method, they can be better heated from one common apparatus than they could by hot water; and best, because the supply of heat by steam can be more rapidly withdrawn than either by hot water or smoke flues. It is true, excessive heat can always be reduced by the admission of air, and by watering; but it is not desirable, in point of economy, as well as for other reasons, that such an excess should be produced. As the simplest mode of conducting the steam, we would suggest carrying it out by main pipes and branch pipes, all sloping from the apparatus, with returning branch pipes and mains for the condensed water, all having an inclination to the apparatus. There ought to be two steam-boilers, each of dimensions to heat the whole structure, and each connected with the same main tubes; so that, if at any time one of them were out of order, the other might instantly be set to work. Under the pathways there might be cast-iron cisterns in different places, to receive the rain water from the roof; and these cisterns might be heated by the steam-pipes. At the same time, the water in the central cistern over the steam apparatus will never be very cold, and might easily be raised to a sufficient temperature for immediate use in the hot-houses, by the introduction of steam from a pipe below.

Fig. 76. is a design which might, if expense were not an object, be substituted for *fig. 75.* In it the whole of the area

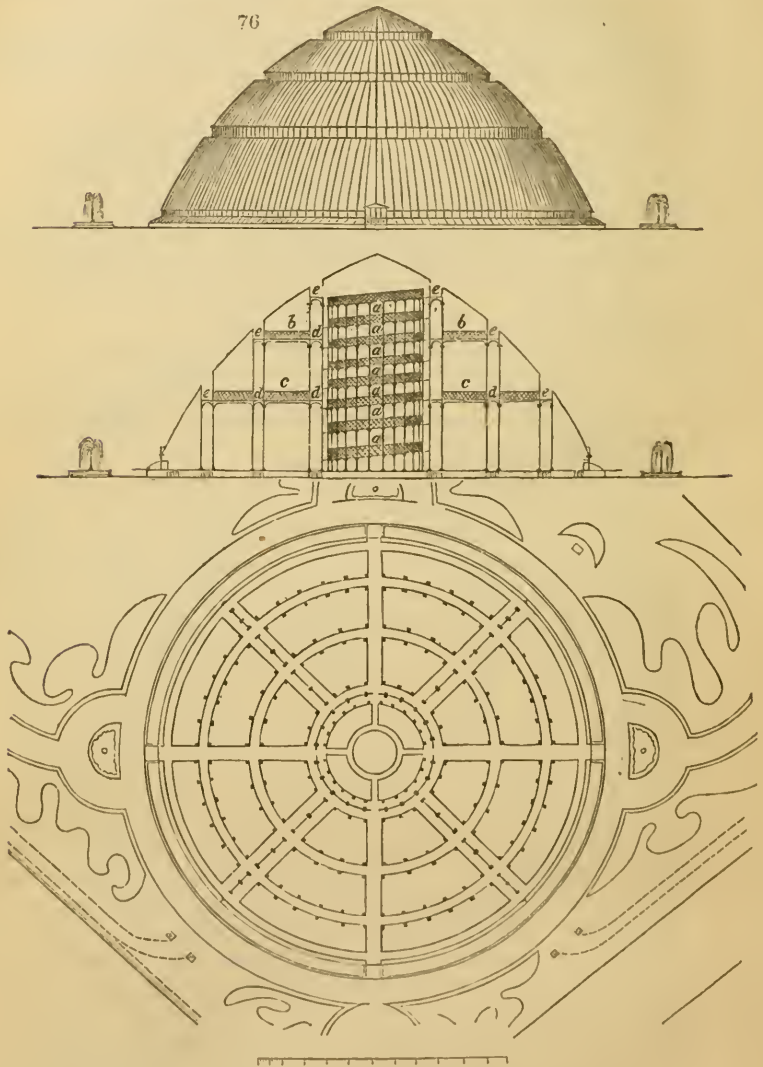

(about an acre) is covered with a conical roof of glass, 200 ft. in diameter at the base, and 100 ft. high in the centre. The plan shows the area laid out in concentric beds and walks; with radiating walks, and four radiating partitions to separate

the four climates. In the centre is a circular partition of glass from the bottom of the roof, the interior of which is 30 ft. in diameter. Here might be planted the most rapidly growing and tallest of the tropical trees; their trunks and branches being clothed with epiphytes and climbers, and the ground covered with ferns: in all probability the *Rafflèsia* might grow in such a situation. Round the inner side of this glass partition it is proposed to conduct a winding inclined plane from the ground to the upper gallery of the structure. In the section (*fig. 76.*) this inclined plane is shown at *a a*, &c., together with the galleries radiating from it, *b, c*, the inside concentric walks, *d d d*, &c., and the outside ones, *e e*, &c. It can hardly be necessary to state, that all the railings to the inclined plane, and to the radiating and circular passages, are proposed to be covered with creepers of different kinds; and, in the tropical division, to be hung over with epiphytes. In the outside galleries matting or oil-cloth might be kept for covering the glass every night during the winter season; and immediately under the glass there might be pipes for watering the whole, water being supplied from a steam-engine; while over the glass there should be a system of conducting rods, for guarding against the effects of electricity. In this design, as in the preceding one, all the glass of the roof admits of being taken off, being constructed in separate gores, resting on rafters, in the manner practised by John Jones and Co. of Birmingham. The removal of all the glass of the roof, for two or three months during summer from the hot-house, and for three or four months from the green-house, will add greatly to the strength of the vegetation of the plants contained in both houses.

There would be no difficulty in erecting such a building, and it would be much more easily heated than *fig. 75.*; but the expense would be too great, except for a very wealthy association. When towns and their suburbs are legislated for and governed as a whole, and not, as they are now, in petty detail, by corporations and vestries; and when the recreation and enjoyment of the whole of society are cared for by their representatives; public gardens, with hot-houses of this sort, or even of far greater magnificence, will be erected, for the general enjoyment, at the general expense.

Fig. 77. shows the ground plan and elevation of that part of the hot-houses which is proposed to be immediately erected, and the temporary arrangement of the area within.

Fig. 78. Plan, elevation, and section of the hot-houses, with the arrangement of the interior area, on the supposition

77

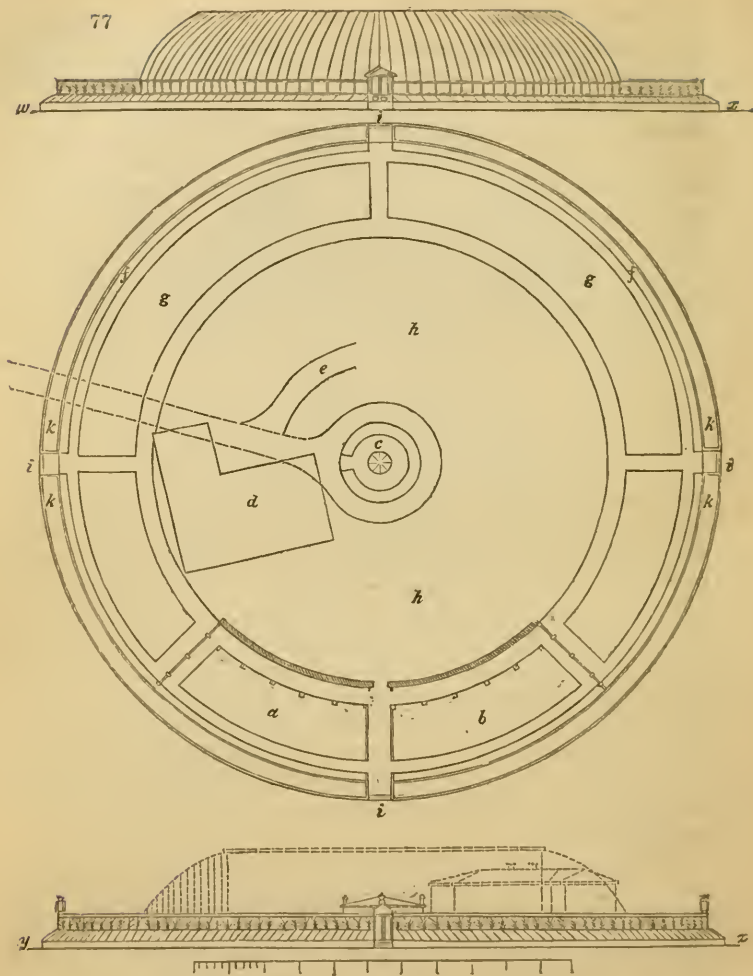

- a*, The conservatory. *b*, The hot-house.
c, Steam apparatus, with the under-ground roadway round it. *e*, Inclined plane to the tunnel.
d, House for the curator and council-room. *f*, Border for trees to be trained on both sides of the fence, as shown in the north elevation.
f, Border for trees to be trained on both sides of the fence, as shown in the north elevation.
g, Border for seedlings and rare plants, &c.
h h, Situation for hot-beds, and beds for seedlings; for rare or tender plants; and for setting out the green-house plants, &c. &c.
i i, &c., The four main entrances across the outside pits from the circular terrace.
k, The pits in four divisions, as in *fig. 76*. *y z*, North elevation.
w x, South elevation.

that only the zone of pits, and the outer zone of hot-houses, were erected, together with the cistern tower.

Having described the various plans submitted, we shall

78

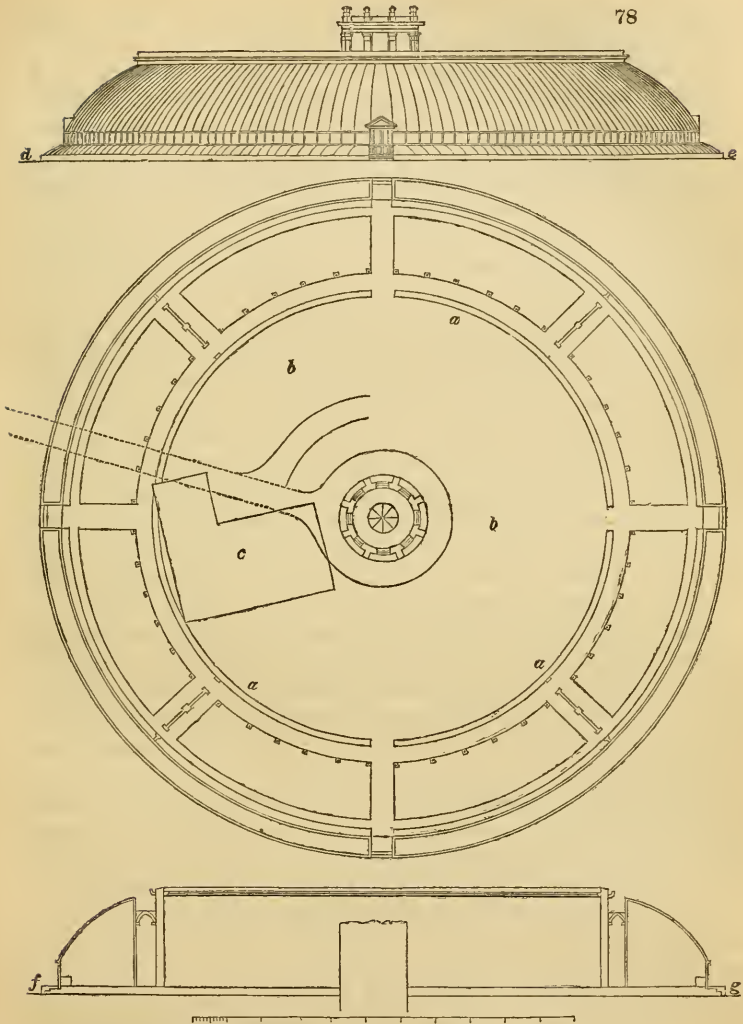

a, Back wall of the hot-houses.
b, Interior area for setting out the green-house plants, &c. &c.
c, Curator's house retained. *d e*, Elevation from any of the four entrances.
f g, Section across the centre.

now offer such suggestions as occurred to us on the spot, respecting the mode of carrying these plans into execution, and the annual expense of managing the garden. We may premise, however, that we did not think it necessary to enquire very minutely into the last of these subjects; because the committee of management and the curator, from their

local knowledge, must necessarily understand them much better than any stranger.

With respect to execution, it is not to be supposed for a moment that the fountains, or the whole, or even one half of the hot-houses are essential to our plan; the whole of the former may be omitted, and no more of the latter need ever be erected than what are shown in *fig. 77*. Indeed, if no more glass were ever erected than what is shown in *fig. 77.*, still, by means of the extensive circle of pits, as good a collection of house plants might be kept, as is to be found in most British botanic gardens.

The following particulars are essential to the effect of our general plan: 1st, that no deviation be made from the circular plan of the hot-houses, however small a portion of that plan may be executed; 2d, that the entrance for garden materials, fuel, &c., to the interior area of these hot-houses, be concealed by a tunnel, as indicated in the plans *figs. 71. 75. and 77.*; 3d, that in the botanic garden (1, in *fig. 71.*) no duplicates be admitted, and not a single plant be introduced for the purposes of shelter or immediate effect; 4th, that no hot-beds, frames, or pits, mushroom beds, or dung-beds of any sort, be permitted to be made any where, except in the interior area of the hot-houses, or in the experimental ground (*fig. 71. p*); 5th, that the situation of none of the gravel walks be altered, and that no new walks be added; and 6th, that walls or buildings of any description be placed in the interior of the kitchen, fruit, flower, or American garden.

For carrying the working-plan (*fig. 71.*) into execution, the first operation is, to form the outline of the circle of hot-houses, and the terrace walk around it, on a perfect level, with the straight central walk in three inclined planes, having perfectly level circles in the situations destined for the fountains, as illustrated by the section *A B* in *fig. 71.* The next thing is, to form the tunnel (*fig. 71. G H*) for the entrance of carts, &c., with manure, fuel, soil, &c., and for the private entrance to the curator's house. The third operation is to form the main walks, 12 ft. broad, round the hot-houses and pleasure-ground, gradually narrowing them to 10 ft. in breadth at the further extremities of the garden, as done in the working-plan. These things being accomplished, or in progress, a section of the hot-houses, amounting to one sixth part, or 100 ft., and the whole outer circumference of pits, 600 ft., may be commenced. The expense of the pits is estimated at 700*l.*; and of 200 ft. of hot-house and green-house at 1000*l.*

It is suggested that only a part of the walks near the hot-

houses need be gravelled in the first instance; not only on account of the expense, but because, as the soil under them will in many places have been loosened to a considerable depth, one whole year, at least, will be required for its consolidation.

The hollow wall for peaches, &c., forming the south-east boundary for the experimental garden, may be deferred till the second or third year; because the circular walling or fencing (*fig. 77. fff*), at the back of the pits, will supply all that can be wanting for some time. The holly hedge round the wall should be planted without delay. The surface of the pleasure-ground and of the botanic garden should be trenched, smoothed, and otherwise prepared for marking out the situations of the beds and trees, and for sowing those parts not occupied with beds with a proper mixture of grass seeds.

The planting of the botanic and ornamental gardens, as there are to be no duplicates, will amount to a very trifling expense; and it is supposed that almost all the plants will be received in presents, or in exchange, from other public establishments.

With respect to the expense of management, much will depend on the use made of the interior of the kitchen, fruit, flower, and American gardens: if these are to be kept as nurseries for the propagation and culture of young plants for sale, they will require the labour of at least three men the greater part of the year; but if the orchard be occupied as an orchard, and the surface of the ground among the trees only kept clear of weeds by hoeing, the kitchen-garden cropped with the commonest crops, and the American garden occupied with large single specimens, then the whole work of these four gardens, exclusive of the walks, may be done by one man; that is to say, for 40*l.* a year one man will undertake it, and will accomplish it. For the same sum, another man may be found who will undertake the surrounding hedges, the walks, and (furnishing him with a mowing machine) all the grass of the pleasure-ground and botanic garden. There will remain for the curator, the hot-houses, the beds in the pleasure-ground and in the botanic garden, and the experimental garden; and this, we think, he might accomplish with the assistance of one man and an apprentice.

It is to be particularly observed, that this calculation is made on the supposition that the whole of the open garden is made and planted, and that there is nothing whatever to do but to keep it in repair. It is also supposed in this guess estimate, that there are no pits or frames in the reserve garden,

and no more glass erected than what is shown in *fig. 77*. It is further to be observed, that so few hands will only serve for keeping the garden in order on the principle of the division of labour, and on that of letting the greater part of the work by the job. It is astonishing what may be done in this way in a private gentleman's garden, provided such terms are given as will enable the jobber to earn a few more shillings per week than he could do by ordinary day's wages. For all the more difficult or nice operations of gardening, however, this mode of proceeding is by no means to be recommended; but it might, with great advantage, be introduced for certain portions of work in every garden whatever. In some of the cleanest and best kept nurseries that we know, great part of the work is done in this way.

When we contrived the foregoing designs of the Birmingham garden, in May, 1831, we left copies of *figs. 71, 72, and 74*, and thought that we had sufficiently explained these designs to the committee and the curator. To our surprise, however, on returning from Scotland, in September of the same year, we found that a straight range of hot-houses had been determined on; and a plan and elevation of this range have been subsequently shown to us. We entirely disapprove of it, and of its position in the garden; and we have no hesitation whatever in saying that we consider the whole of our design completely spoiled, as the general effect depended entirely on the glass-houses being circular in the plan. We only regret that the committee have adopted our circuitous line of main walk (which, indeed, we staked out when on the spot), because we dislike exceedingly the idea of having our name associated in any degree, however slight, with a garden which, though it might have been one of the most perfect in its kind existing any where, and altogether unique in some of its arrangements, is now bungled, and never likely to reflect credit on any one connected with it.

ART. V. *On the History and Culture of the Carnation.* By EDWARD RUDGE, Esq. F.R.S. F.S.A. F.L.S. and F.H.S., President of the Vale of Evesham Horticultural Society. Read at the Meeting of the Society, July 24. 1828.*

UNDER the genus *Dianthus* of Linnæus are classed the carnation, the pink, the picotee, and the sweetwilliam, with all

* The papers of the president were not written for competition for the medal, but for the purpose of inducing other members of the Society to give communications on such subjects of improved modes of culture as, by experience, had been proved to be successful and preferable.

their various species and varieties. No genus, except, perhaps, that of roses, has been so little understood, or so inaccurately described, by our earliest writers; and this obscurity does not seem to have arisen, as in the geranium tribe, from a casual intermixture of the species, either in a wild or cultivated state; nor from the great number of the species, as in the genus *Rosa*, very nearly resembling each other; nor from the great difficulty of defining, by methodical characters, their specific differences; but the principal source of confusion has been occasioned by the incorrect attention of early writers to a just discrimination of the respective species, and their almost infinite varieties.

Gesner and Cæsalpinus, by their genius, first dispelled this cloud of ignorance; while the scrupulous fidelity and accuracy of the botanical figures of Clusius marked with precision the line of discrimination, and settled, with a more faithful delineation, the distinction of the species both of this and of many other genera. Parkinson, in his *Paradisus*, published in 1629, has given figures, and a particular account, of such carnations as were cultivated in his time. He divides them into two sorts, large and small: to the former he gives the name of carnations; and to the latter, gilloflowers. He supposes the old name of gilloflower to be corrupted from July-flower; and Rea, in his *Flora*, has adopted the same idea. But in this respect they are both mistaken; for the name is evidently derived from the French word *girofle*, a clove, from the smell of the flower resembling that of a clove.

Many of the celebrated varieties of the carnation, in great esteem in former times, are figured in Parkinson's *Paradisus*, in Besler's *Hortus Eystettensis*, in Swertius's *Florilægium*, and in several other celebrated authors of that time. Rea, in his *Flora*, published in 1676, gives a catalogue of 360 good sorts of carnations. Parkinson recites 19 principal sorts of carnation and 30 varieties of gilloflowers. Gerarde informs us that the yellow or orange tawny gilloflower, which had then been but lately introduced, and at this time is in little esteem, had been procured from Poland by Master Nicholas Lete, a worshipful merchant of London; who gave it to him for his garden near London, situated on the spot where Holborn now stands; and which flower, before that time, was never seen or heard of in these countries.

Although the catalogue given by Parkinson has been supplanted by modern flowers, and new ones are continually produced by the indefatigable florists of the present time in considerable numbers, one gardener in the Vale of Evesham having raised this season upwards of 2000 seedlings; it may not be

unacceptable to the curious, to enumerate the list of those carnations which were most in esteem two centuries ago: —

Grey, red, and blue Hulo	Oxford carnation
Grimelo, or Prince carnation	King's, or great Bristol carnation
White or delicate	Greatest granado
French carnation	Granpere
Great Harwich	Cambersine
Striped, the Blush, and the Red savage	Great Lombard red carnation.

Amongst the 30 sorts of gilloflowers, or second class of carnations, given us by Parkinson, particular mention is made of various sorts raised by Master Tuggy of Westminster, particularly his princess carnation, of which Parkinson has given a figure. In referring to this work, Johnson, in his edition of Gerard's *Herbal*, published in 1636, says: — "If any one requires further satisfaction, let him, at the time of the year, repair to the garden of Mistresse Tuggy (the wife of my late deceased friend Mr. Ralph Tuggy of Westminster); which, in the excellence and variety of these delights, exceedeth all that I have seen; as also he himself, whilst he lived, exceeded most, if not all, of his time, in his care, industry, and skill in raising, increasing, and preserving of these plants, as well as others; whose loss, therefore, is the more to be lamented by all those that are lovers of plants."

From the time of Parkinson till the establishment of societies for the encouragement of the cultivation of flowers and fruits, few, besides the varieties of the carnation known in his time, continued to be cultivated by the professional gardeners for sale; but, about the beginning of the last century, the first florists' society was established, comprising many of the most eminent gardeners residing near London; who, in 1730, published a volume, with coloured figures, of such rare trees and plants as were then first introduced into this country. In their preface to this work, they declare that they were associated for the purpose of comparing such new kinds of plants as were annually introduced into the English gardens; to correct thereby former errors; and, by comparison, to guard against new species being confounded with such as were already in the English gardens. For the better carrying on of this design, and presuming that they possessed as great a variety of all the different kinds of trees, shrubs, plants, flowers, and fruits, as any set of gardeners of their number in England (or perhaps in Europe) can boast of, they came to a mutual agreement to meet together, monthly, at some convenient place, where each member of the society brought various kinds of plants, flowers, and fruits, in their seasons;

which were there examined by all the members present, and their names and descriptions registered from time to time. From this origin, in 1730, societies were afterwards established in several places, to encourage by prizes, and such honours as they were enabled to award, the cultivation of such fruits and flowers as were considered most generally useful and ornamental; amongst which the carnation has always been considered as a most prominent object.

Modern florists divide the carnation into four classes: —

1. The Bizarre: the flowers of which are striped or variegated with irregular spots and stripes; the colours of which are scarlet or crimson.

2. Flakes, which consist of three colours, with large stripes going quite through the petals: the stripes are scarlet rose, or purple.

3. Picotees (a French word, signifying spotted or dotted). These flowers have always a white ground, [picotees with a yellow ground are now extant,] and are spotted or pounced with scarlet, red, purple, or other colours.

4. The fourth class, little noticed by florists, are called Painted Ladies. These have their petals of a red or purple colour on the upper side, and are white underneath.

Of each of these classes there are numerous varieties, especially of the picotees, which, some years ago, were in most esteem with florists; but, of late years, the bizarres and flakes have been more attended to, and in greater request. To enumerate the varieties would be endless, as they are not permanent; and new flowers are produced from seed every year, which at first raising are very highly valued, but become so common in a few years as to be little regarded, especially if they prove to be defective in any one essential property, when, by the fickleness that prevails amongst florists, they are, at the next selection of seedlings, to make room for new comers.

The following are what the florists call the good and requisite properties of a carnation: —

1. The stem of the flower should be strong and straight, not less than 30 in., nor more than 45 in. high, and able to support the weight of the flower without hanging down, which flower should at least be 3 in. in diameter.

2. The petals should be long, broad, and stiff, easy to expand and make free flowers, the lower or outer circle of petals, commonly called the guard leaves, should be particularly substantial; they should rise perpendicularly, about half an inch above the calyx, and then turn off gracefully in a horizontal direction, supporting the interior petals, which should decrease gradually in size as they approach the centre, and with them

the centre should be well filled. All the petals should be regularly disposed, and lie over each other in such a manner as that their respective and united beauties should meet the eye altogether; they should be nearly flat, or with only a small degree of inflection at the broad end; their edges should be perfectly entire, without notch, fringe, or indenture; the calyx should be at least an inch in length, sufficiently strong at the top to keep the bases of the petals in a close and circular body.

3. The middle of the flowers should not rise too high above the other parts.

4. The colours should be bright, and equally marked all over the flower, perfectly distinct, the stripes regular, narrowing gradually to the claw of the petal, and there ending in a fine point. Almost one half of each petal should be of a clear white, free from spots.

5. The flower should be very full of petals, so as to render it, when blown, very thick in the middle, and the outside perfectly round.

These flowers are propagated either by seed or by layers: the first is the method for raising new flowers; the other is the way to preserve and multiply those of former years.

To raise them from seed, that from the best double flowers should be selected, which will produce the strongest plants, and should be sown in April, in pots or boxes of fresh light earth mixed with rotten cow manure, exposed to the morning sun, and occasionally watered. In a month the plants will appear, and in July should be transplanted into beds of the same earth, in an open airy situation, at 6 in. distance, and there left to flower. When in flower, the finest kinds should be marked, and all the layers that can be, should, during the time of flowering, be laid down from them; these will have taken root by the end of August, and are then to be taken off and planted out in pots in pairs.

[CARNATIONS are grown remarkably well in the neighbourhood of London, more especially by Mr. Hogg at Paddington, whose catalogue, in a folio sheet for being sent by post, is worth having by all florists. They are still better grown at a distance from the London smoke, even so near it as at Hammersmith, by Mr. Weltje. They attain still greater beauty at Ipswich, with Mr. Woolard; but more especially at Northampton, with Mr. Cornfield, who is generally considered the first grower in England.]

REVIEWS.

ART. I. *Transactions of the Horticultural Society of London.*
Second Series. Vol. I. Part I. 4to. London, Hatchard.

(Continued from p. 321.)

5. *On the Cultivation of the Vine on the open Wall at Croxdale.*
By W. T. Salvin, Esq. F.H.S. Read Nov. 17. 1829.

THE vines are planted against a common flued wall, without glass, or any other kind of covering, and trained and pruned in the usual way. Vines have been grown on the open wall at Croxdale ever since 1725; and under Mr. Salvin's direction for the last twenty-nine years. The fireplaces are made in the form of ovens, in order that wood may be burned in them; that fuel being preferred, though Croxdale is a coal country. The reason is, "wood produces a more steady heat, by the management of the fires in the following manner:—After an accumulation of ashes is produced in the oven, they should be used to cover the embers at night, or at any time when those who attend the fires retire to rest, and also to regulate the fire during the day when less heat is required. The red-hot charcoal, so covered, will continue to give out heat for several hours, and is ready to rekindle a fresh supply of wood; whereas coal requires more constant attendance, or it will soon go out. I begin to light the fires in the ovens as soon as the buds begin to break in April, and continue them night and day till the fruit is perfected, except a few weeks in July and August, if the season is hot."

6. *An Account of a new Variety of Plum.* By T. A. Knight, Esq. F.R.S., President. Read July 6. 1830.

Raised from seeds of the purple *Impératrice*, fecundated with the pollen of *Coe's golden drop*.

7. *A Report upon the Varieties of Apricot cultivated in the Garden of the Horticultural Society.* By Mr. Robert Thompson, Under-Gardener in the Fruit Department.

[Who is the *head-gardener* in this department? If there is none, why is Mr. Thompson called *under-gardener*? We suspect this to be a remnant of the *ancien régime* of the

garden. (See Vol. I. p. 314.) At all events, it ought to be done away with.]

The classification is as follows :—

I. Kernels bitter. 1. Fruit small, round, early; flowers small; red and white masculine. 2. Fruit large: *a.* channel of the stone closed up, and flesh parting from the stone; Roman, Royal, Brussels, &c. *b.* Channel of the stone closed up, and flesh adhering to the stone; Montgamet. *c.* Channel of the stone pervious; Moorpark and Hemskirke.

II. Kernels sweet. 1. Flesh parting from the stone. Breda, Turkey, &c. 2. Flesh adhering to the stone; Orange.

8. *Upon an Improvement in the Mode of raising annual Flower Seeds.* By Mr. Joseph Harrison, Gardener to the Lord Wharncliffe. Read April 20. 1830.

“After sowing the patch of seeds, and covering it with fine moist soil, I place a garden pot inversely over it: this remains till I discover that the seeds have struck root, when I raise the pot up two or three inches; keeping it thus supported for a few days, and then remove it entirely. I find that the pot not only keeps the soil moist, but, by the sun heating the pot, the seeds come up much more quickly than otherwise they would do: in consequence of which, I do not sow the seeds so early by a fortnight, or upwards, as I used to do previously. The young plants are therefore less exposed to injury from cold, or late spring frosts. I have used hollow tiles instead of pots, which answer equally well; except that where mice are, they have access at the ends.”

9. *On the Destruction of Snails.* By Mr. James Corbett. Read Sept. 15. 1829.

Quicklime is sprinkled lightly over the places infected, about 3 o'clock in the morning. This is a very inferior mode, and much more expensive and troublesome, than that of watering in the evening with limewater; repeating the operation on the same ground, at about a quarter of an hour's interval.

10. *An Account of a Method of obtaining very early Crops of Green Peas.* By T. A. Knight, Esq. F.R.S., President. Read May 18. 1830.

The peas are sown in pots of about 9 in. in diameter, and placed in a hot-bed about the middle of January. Two dozen peas are placed in each pot in a circular row, and a circle of twigs a foot high is stuck in beside them. About the middle of March the peas will be 14 in. high, and may then be transferred to the open border.

11. *On the Management of Camellias when forced.* By Mr. Thos. Blake, F.H.S., Gardener to the Lord Rolles, F.H.S. Read May 19. 1829.

“Most shrubs and plants will force, but there is an exception in the camellia. It struck me that I could bring the varieties more regularly and quickly into flower by forcing them into bud. I take the plants as soon as they are out of flower; I shift them by taking some of the old mould off the bulb, and adding some rich compost, such as I use for pines. I then place them in a plant stove; the sudden transition from cold to heat causes them to throw out young wood directly; and as soon as I can perceive flower-buds, I remove them back to the green-house till July: I then put them out as much in the shade as possible. By this simple process, I am enabled to keep a succession of flowers from November to the following May. Plants, when once early excited, appear to look for it the same season again. People in possession of a quantity of pots should not wait for many together, but shift them progressively as they go out of flower. This communication more immediately concerns gardeners than others, as there are few places but where the lady wishes to have a succession of flowers through the year for her sitting-room. I think they cannot do better than attend to the three following varieties of plants:—*Chrysanthemums*, *camellias*, and *Azalea indica*; the last-mentioned plant I treat nearly the same as *camellias*.”

12. *Some Remarks on the Cultivation of the Strawberry.* By Mr. John Fairbairn. Read June 1. 1830.

Flat tiles, painted black, are laid down round the plants, just as they are going out of flower. The tiles seem to be formed on purpose; for they are described as having at least half a circle cut out of each tile, in order that they may fit closely to the plants. “The tiles during the day will not only prevent the exhalation of moisture from the soil, but also collect a great body of heat from the sun, and consequently form the fruit early, large, and well flavoured, as well as clean from sand.”

13. *Upon the Cultivation of the Persian Varieties of the Melon.* By T. A. Knight, Esq. F.R.S., President. Read May 1. 1831.

Pots 16 in. wide, and 14 in. deep, are filled with rich soil, and in each is placed one plant. The pots are set along the front flue of a forcing-house, and the plants trained up a trellis under the glass, and only one melon allowed to swell on each plant.

14. *On the Cultivation of the Horseradish, as practised in Denmark and Germany.* By M. Jens Peter Petersen. Read November 6. 1827.

“ In the autumn, when the roots are taken out of the ground, select all the small side roots from 9 to 12 in. in length, and as thick as a quill, or thereabouts; tie them in bunches, and preserve them in sand in a place protected from the frost, during the winter. The planting is commenced in the beginning or middle of April. In dry weather, divide the ground into beds 4 ft. wide (some make them only 3 ft. wide). These beds are with me raised a little with the mould out of the alleys, so that they are about a couple of inches higher in the middle than on the sides next the alleys. With a woollen cloth rub off all the lateral fibres from the roots above described, and also pare off each extremity, so that the wounds may be fresh; then plant them, by inserting them horizontally into the sides of the elevated beds, about a foot apart, and in a quincuncial manner, so that the bottom part of the root is about 6 or 7 in. below the surface, and the top, or crown end of the root, stands a little out of the side of the bed, remembering that the roots are to be inclined a little, so that their lower extremity is rather deeper than their upper. In the latter end of June, or some time in July, cut off with a sharp knife all the lateral fibres of each root, which is done by placing the foot on the lower extremity, and carefully lifting the root out of the ground as far as may be necessary. This operation is performed two or three times every summer. When the operation is over, replace the roots as before, and cover them with mould. The roots or fibres which are left at the end of the main root, and not disturbed (for the operation must be done carefully), are sufficient to nourish the plant. In the third year the roots have attained their full size. Laying the roots horizontally has this advantage, that they are easily taken out of the ground without breaking; while cutting off the side roots makes the main root grow straight and thick. It is advisable to plant a bed every year. To keep the ground clear of weeds need not be mentioned.”

15. *On the Potato.* By T. A. Knight, Esq. F.R.S., President. Read Feb. 1. 1831.

Mr. Knight is convinced by the evidence of experiments, “ that the potato plant, under proper management, is capable of causing to be brought to market a much greater weight of vegetable food, from any given extent of ground, than any other plant which we possess.” There is no crop, he says, “ so certain as that of potatoes; and it has the advantage of being generally most abundant, when the crops of wheat are defective; that is, in wet seasons.” The following observations are extremely interesting:—

“ I think I shall be able to adduce some strong facts in support of my opinion, that by a greatly extended culture of the potato for the purpose of supplying the markets with vegetable food, a more abundant and more wholesome supply of food for the use of the labouring classes of society may be obtained, than wheat can ever afford, and, I believe, of a more palatable kind to the greater number of persons. I can just recollect the time when the potato was unknown to the peasantry of Herefordshire, whose gardens were then almost exclusively occupied by different varieties of the cabbage. Their food at that period chiefly consisted of bread and

cheese, with the produce of their gardens; and tea was unknown to them. About sixty-six years ago, before the potato was introduced into their gardens, agues had been so exceedingly prevalent, that the periods in which they, or their families, had been afflicted with that disorder, were the eras to which I usually heard them refer in speaking of past events; and I recollect being cautioned by them frequently not to stand exposed to the sun in May, lest I should get an ague. The potato was then cultivated in small quantities in the gardens of gentlemen, but it was not thought to afford wholesome nutriment, and was supposed by many to possess deleterious qualities. The prejudice of all parties, however, disappeared so rapidly, that within ten years the potato had almost wholly driven the cabbage from the garden of the cottagers. Within the same period, ague, the previously prevalent disease of the country, disappeared; and no other species of disease became prevalent. I adduce this fact, as evidence only, that the introduction of the potato was not injurious to the health of the peasantry at that period; but whether its production was, or was not, instrumental in causing the disappearance of ague, I will not venture to give an opinion. I am, however, confident, that neither draining the soil (for that was not done), nor any change in the general habits of the peasantry, had taken place, to which their improved health could be attributed. Bread is well known to constitute the chief food of the French peasantry. They are a very temperate race of men; and they possess the advantages of a very fine and dry climate. Yet the duration of life amongst them is very short, scarcely exceeding two thirds of the average duration of life in England; and in some districts much less. Dr. Hawkins, in his *Medical Statistics*, states, upon the authority of M. Villerme that, in the department of Indre, "one fourth of the children born die within the first year, and half between fifteen and twenty; and that three fourths are dead within the space of fifty years. Having enquired of a very eminent French physiologist, M. Dutrochet, who is resident in the department of Indre, the cause of this extraordinary mortality, he stated it to be their food, which consisted chiefly of bread; and of which he calculated every adult peasant to eat two pounds a day. And he added, without having received any leading question from me, or in any degree knowing my opinion upon the subject, that if the peasantry of his country would substitute (which they could do) a small quantity of animal food, with potatoes, instead of so much bread, they would live much longer, and with much better health. I am inclined to pay much deference to M. Dutrochet's opinion; for he combines the advantages of a regular medical education with great acuteness of mind, and I believe him to be as well acquainted with the general laws of organic life as any person living: and I think his opinion deserves some support, from the well-known fact, that the duration of human life has been much greater in England during the last sixty years, than in the preceding period of the same duration. Bread made of wheat, when taken in large quantities, has probably, more than any other article of food in use in this country, the effect of overloading the alimentary canal; and the general practice of the French physicians points out the prevalence of diseases thence arising amongst their patients. I do not, however, think, or mean to say, that potatoes alone are proper food for any human being: but I feel confident, that four ounces of meat, with as large a quantity of good potatoes as would wholly take away the sensation of hunger, would afford, during twenty-four hours, more efficient nutriment than could be derived from bread in any quantity, and might be obtained at much less expense."

Mr. Knight then proceeds to give an account of the result of his experiments in raising new varieties of potato from

seed, and in growing crops in different soils and situations. He raises new varieties from seeds, chiefly by the aid of artificial heat, by which means he obtains, within the first year, a specimen of the produce.

“ In raising varieties of the potato from seeds, it is always expedient to use artificial heat. I have trained up a young seedling plant in a somewhat shaded situation in the stove, till it has been between 4 ft. and 5 ft. high, and then removed it to the open ground in the beginning of May, covering its stem, during almost its whole length, lightly with mould; and by such means I have obtained, within the first year, nearly a peck of potatoes from a single plant. But I usually sow the seeds in a hot-bed early in March, and, after having given them one transplantation in the hot-bed, I have gradually exposed them to the open air, and planted them out in the middle of May: and, by immersing their stems rather deeply into the ground, I have within the same season usually seen each variety in such a state of maturity, as has enabled me to judge, with a good deal of accuracy, respecting its future merits. I stated, in a former communication, two years ago, that I had obtained from a small plantation of the early ash-leaved kidney potato, a produce equivalent to that of 665 bushels, of 80 pounds each, per acre; and my crop of that variety, in the present year, was to a small extent greater. By a mistake of my workmen, I was prevented ascertaining, with accuracy, the produce, per acre, of a plantation of Lankman’s potato: but one of my friends having made a plantation of that variety, precisely in conformity with the instructions given in my former communication to this Society, I requested that he would send me an accurate account of the produce; which I have reason to believe he did, for its amount very nearly agreed with my calculation upon viewing the growing crop about six weeks before it was collected. The situation in which this crop grew was high and cold, and the ground was not rich; but the part where the potatoes to be weighed were selected was perfectly dry, and afforded a much better crop than the remainder of the field, which was planted with several different varieties. I calculated the produce of the selected part to be 600 bushels per acre; and the report I received, and which I believe to have been perfectly accurate, stated it to be 628. If this produce be eaten by hogs, or cows, or sheep (for all are equally fond of potatoes), I entertain no doubt whatever that it will afford twenty times as much animal food as the same extent of the same ground would have yielded in permanent pasture; and I am perfectly satisfied, upon the evidence of facts, which I have recently ascertained, that if the whole of the manure afforded by the crops of potatoes above mentioned be returned to the field, it will be capable of affording as good, and even a better, crop, in the present year, than it did in the last; and that as long a succession of at least equally good crops might be obtained as the cultivator might choose, and with benefit to the soil of the field. Should this conclusion prove correct, a very interesting question arises, viz., whether the spade husbandry might not be introduced upon a few acres of ground surrounding, on all sides, the cottages of day-labourers, to and from every part of which the manure and the produce might be conveyed, without the necessity of a horse being ever employed. A single man might easily manage four statute acres thus situated, with the assistance of his family: and if nothing were taken away from the ground, except animal food, I feel confident that the ground might be made to become gradually more and more productive, with great benefit to the possessor of the soil, and to the labouring classes, wherever the supply is found to exceed the demand for labour.”

16. *On a Method of forcing Cherries.* By Mr. Benjamin Law.
Read June 1. 1829.

“I put the cherry trees into my houses, giving them but very little water at the close of the year, by which I find them better prepared for blooming strongly in the spring. Their pots have a capacity of from two quarts to two gallons, according to the size of the plants; but the soil in which they are planted is by no means rich; for I have observed that highly manured soil is apt to make the shoots too luxuriant, and to cause them to gum. When I begin to force, I continue to water but sparingly, and take care to admit, both by night as well as by day, as much air as the weather will permit: this is particularly necessary; for there is nothing which is so much calculated to render the cherry impatient of forcing, as alternate ventilation in the day and confinement at night. I open my back lights, in almost any weather, close to the trees. In frosty weather, I increase my fire as much as may be necessary to enable me to continue to give air without actually allowing the temperature to fall to 32°. In this manner I proceed very slowly, until the blossoms are all set; at which time, if the forcing has been well conducted, the foliage should be a deep green, firm, and perfectly well formed. I subsequently raise the temperature, at first, to 65°, and afterwards gradually to 70°; increasing the moisture of the atmosphere at the same time, and always taking care to keep the ventilation as abundant as I possibly can. By this means I find the crop of cherries certain and abundant, without the use of tan, leaves, or any bottom heat.”

17. *A Report upon some new Seedling Pears raised by* Thomas A. Knight, Esq. F.R.S., President. Read March 15. 1831.

The names of these pears will be found in the Society's *Catalogue of Fruits*. Some of them are good, others indifferent.

(To be continued.)

ART. II. *Memoirs of the Caledonian Horticultural Society.* Vol. V.
Part I. 8vo. Edinburgh, Maclachlan and Stewart.

1. *Account of the Mode of transplanting Evergreens, and also large Deciduous Trees, practised at Pinkie for upwards of Thirty Years.* By Mr. James Stuart, Gardener to Sir John Hope, Bart. Read March 3. 1831.

EVERGREENS.—The pits are to be prepared from 5 ft. to 8 ft. in diameter, and from 2 ft. to 3 ft. in depth; rather wider at the bottom than at the top; and the earth, taken out and placed in two heaps: the one, surface, or good soil, fit to put about the fibrous roots; and the other, subsoil, to be partly used, and partly carried away. Before removing the plants, tie up their lower branches, and draw a circle on the earth, round each plant, in proportion to its size. Plants of 6 ft. or 7 ft. in height “will require a circle 3 ft. in diameter; and taller plants a proportionally larger one. Next, carefully dig a trench about 2½ ft. on the outside of the circle, and to

such a depth that its bottom shall be 6 in. below the roots of the tree; carefully paring round the circle, so that the ball of earth may be preserved entire. When the ground is of a sandy or gravelly nature, it will be necessary to begin at the bottom of the bulb, and wrap it closely round with hay ropes till you come within 3 in. or 4 in. from the surface. As sandy or gravelly ground has a tendency to fall from the roots, it will be necessary, in order to prevent this, to raise the plant gently on one side, to place under it a little straw, and to bind this with hay ropes; and then to raise it on the other side likewise, and secure it in the same manner. In order to lighten the ball as much as possible, pare off a little earth from the top of it, to the depth of the surface roots. That the plant may be safely conveyed to the place intended for it, you must be provided with a deal-bottomed handbarrow and truck. The mode of getting the plant on the barrow is, by raising it on one side, pressing in the edge of the barrow, and sliding the plant gently on till it be fairly balanced."

In placing the plant in the pit, "lay the steels of the barrow 15 in. or 18 in. over the pit," in which there should be two men ready to receive the plant; and then "let one or two persons raise the other end of the barrow to such a position that the plant may slide gently into the centre of the pit." Being placed upright, fill in round it the best part of the surface soil; and when within 3 in. of the surrounding surface, put in decayed leaves to the depth of 3 in. After this, cover up the whole with the inferior or subsoil taken from the bottom of the pit, forming a basin round the plant for retaining water. Tread in the soil a little, if it should be found necessary; but depend chiefly upon watering, for consolidating it about the roots. From ten to twenty large pots of water should be immediately given, according to the size of the plant and the quantity of loose earth in the pit. If the weather should prove dry afterwards, the leaves should be watered in the evenings. Mr. Stuart has planted evergreens with success at all seasons; but he considers the last three months of the year best, when the weather is mild.

Forest Trees from 10 ft. to 25 ft. high, and the Trunk measuring, breast-high, from 5 in. to 18 in. in Circumference. — Proportion the pits to the trees. For trees 10 ft. high, the pits ought to be 5 ft. in diameter; for 15, 6 ft., and for 25, 9 ft. in diameter. The depth should be from 2 ft. to 3 ft., and the width at bottom 1 ft. more than at top. Separate the soil as before directed. In taking up the trees, describe a circle of 4 ft. in diameter round those which are 10 ft. high; of 7 ft. or 8 ft. round those which are 25 ft. high; and so on in propor-

tion. Around the outsides of the circles dig trenches $2\frac{1}{2}$ ft. wide, and so deep as to be 6 in. below the general run of the horizontal roots. Use a fork, so as to preserve the roots which may be met with in the trench as entire as possible. "When we have got completely under the tree in one quarter of the circle, it is necessary to tie those roots together which have been cleared of the earth, and to cover them with a mat, lest they should be injured by being exposed to the air before we have got round the rest of the tree. If the ground happen to be of a gravelly nature, a short-handled pick will be necessary in undermining the roots. In this manner we proceed till the whole of the roots be completely cleared. If the tree have several contending tops, cut off all except the most promising; and if the branches be very numerous, thin them moderately in proportion to the number of the roots."

In planting, place the leading top of the tree in that direction from which the strongest winds are found to blow. "The position being fixed, we then proceed to fill in the best earth for 1 ft. around the tree, up to the place from which the roots first strike off, taking care to pack it firmly with the hands under the tree, and to fill closely up all the vacuities between the roots. During this operation, the person holding the tree must be cautious that it be not shifted from its upright position. The planter must keep his feet fixed in one position, proceeding to lay out the undermost set of roots, as far as he can reach with his hands, in a horizontal direction, covering them with 3 in. of earth; and so proceed until he arrive at those on the surface. We might have mentioned, that all injured or broken roots must be cut out; that the others should be made smooth at the end as they are laid out; and that, if the smaller ones be numerous, a portion of them should be cut off, and the rest carefully combed out. When the roots are covered to within 1 in. of the level of the ground, spread the whole with rotted tree leaves to the depth of 3 in.; over these again lay 2 in. in depth of the inferior mould, forming a basin, according to the size of the circle, in the same manner as for evergreens. In watering the trees, observe to pour upon them from ten to twenty large pots of water, in proportion to the size of the tree and the moistness of the earth in the pit.

"In the mode now described, I have, for thirty years past, been occasionally in the practice of transplanting forest trees of various sizes, frequently more than 20 ft. high, and with stems $1\frac{1}{2}$ ft. in circumference; and I have done so with perfect success. I need scarcely add, that this was long before I heard of the transplanting of trees at Allanton Park.

“My experience enables me to say, that forest trees in general may be planted with success, in mild weather, from the time that they throw their leaves till the bud be again considerably swelled.”

Mr. Stuart prunes at all seasons, but prefers summer for that operation. We give the following part of this valuable paper in the author's own words, because it has reference to the unmerited and ill-natured attack made by Sir Henry Steuart upon practical gardeners:—

“In March, 1804, I transplanted a tree, which, by actual measurement, is now, at breast-height, 6 ft. 2 in. in circumference, above 70 ft. in height, and the branches extend over a space 100 ft. in circumference. In 1808 I planted several, which now measure above 70 ft. high, and 5 ft. in circumference, at breast-height. In 1822 I planted, I think, above 100; some of which are now 46 ft. high, 2 ft. 10 in. in circumference, at breast-height; others 2 ft. 6 in., and so on. I cannot ascertain the exact number of trees I have transplanted; I may, however, say with safety, that I have transplanted upwards of a thousand large ones. They are of the following kinds:—Oaks of different sorts, elm, beech, Spanish chestnut, walnut, plane or sycamore, ash, birch, thorn, horsechestnut, woolly-leaved poplar, black Italian poplar, and some fruit trees occasionally. The following are the different kinds of evergreens which I have planted:—Evergreen oak, evergreen cypress, Virginian cedar, yew, arbutus, Portugal laurel, *laurus-tinus*, laurel bay, holly, and evergreen privet. Some of those which were planted in 1783 now stand 20 ft. high, and measure upwards of 100 ft. around the branches. Two of the evergreen cypresses are very old, being above 20 ft. high, and with stems nearly 2 ft. in circumference. Perhaps this paper may attract little notice; coming, as it does, from one of those whose ignorance in this mode of planting has lately been held up to the ridicule of the public; and whose labours, in the estimation of some, are now superseded by the introduction of the machinery system. I humbly submit it, however, to the consideration of my professional brethren: and if, in their experience, it be followed, in one instance even, by the same result as in my own, I shall think that I have gained a successful triumph over all these ill-grounded insinuations, and shall reckon myself amply recompensed for my labour. I may, perhaps, be excused for here mentioning the names of some of the young men who were employed in the transplanting operations at Pinkie, under my directions; viz. John Stewart, now gardener at Galloway House; Alexander Melville, now gardener to George Heriot's Hospital; John Murray, now gardener at Chapel; James Cribbace, now a gardening undertaker for making ponds, &c.; Peter Clephane, Nicol Cathie, Hugh Litster, John King, and George Anderson.”

(*To be continued.*)

ART. III. *Verhandlungen des Vereins zur Beförderung des Gartenbaues in den Königlich Preussischen Staaten. Transactions of the Society for the Advancement of Gardening in the Royal Prussian States.* 4to. Vol. IV. Berlin, 1828.

THIS volume does not contain much information applicable to the gardens of Britain, with which our readers are not

already familiar; it abounds, however, in local notices of productions, new or remarkable, raised in different parts of Prussia and other German states; which show the very general taste for gardening and plants in that part of the Continent, and the rapid progress making in their culture.

1. *Notices of what passed at the Meeting of Jan. 7. 1827.*

M. Hartweg, inspector of the grand-ducal gardens at Carlsruhe, sent a packet of celeriac [turnip-rooted celery] seeds, with some remarks on their culture. Less care is required in bringing celeriac to perfection than is generally believed: the soil should be light, rich, and sandy, rather than loamy. The seed should not be sown so early as that of the common celery, otherwise the root-stock grows too large, and becomes hollow. The time for sowing it at Carlsruhe is the beginning of March; and, for transplanting, the beginning of May. Water must be supplied liberally during the whole season; and about the end of summer the roots will be found from 18 in. to 22 in. in circumference.

2. *On the Effects of Frosts on Fruit Trees during the Winters of 1823 and 1826.*

3. *Extracts and Translations from the London Horticultural Transactions.*

Upwards of fifty pages, chiefly on the culture of the strawberry and the pine-apple.

4. *Notices of what took place at the Meeting of Feb. 4. 1827.*

Professor Link made known to the Society a communication which he had received on the growth of the truffle (*Tuber cibarium Sibth.*) in West Prussia. The truffle is found in all the islands of the Vistula on which oaks or elms grow. The soil in which the truffle abounds consists of the mud which remains after the overflowing of the river. This mud, however, often contains sand; and in that case the truffles are smaller, and not so plentiful. Moisture is essential to their growth, as proved by their abounding on those islands which are often inundated; while on others, which the water does not reach, they do not grow. In dry weather, they are found almost on the surface of the ground; but their usual position varies in depth from 3 in. to 12 in., in proportion to the moisture. Pigs are employed to discover truffles; and they may certainly be expected in the same place where they grew the preceding year. Under favourable circumstances, they will be fit for use in August; but, for exportation, they should be gathered in October and November, which is their proper period of perfection; although, in good weather, their

season will be prolonged until December, or even till February. M. Link observed that the truffle has a number of whitish arteries, which, seen through a magnifying glass, appear to consist of small cells containing kernels. It is, however, not yet known how these kernels or seeds come forth, and occasion the multiplication of the root. Another fungus, growing under ground, the substance of which becomes, after it is decayed, like powder, is sometimes mistaken for the truffle; but in quality they are very different.

[Dogs, not pigs, are employed in England to scent out truffles. The man, who obeys the dog's indications, sometimes rewards him for every discovery by imparting to him a portion of some preparation of cheese; at least, this was the good fortune of a little dog expert at hunting truffles, which, some years since, was kept on the estate of Lord Braybroke, at Audley End, Essex. — *J. D.*]

5. *On the Culture of shifting Sands.*

The usual creeping roots are recommended, including broom, restharrow, and *Genista tinctoria*. Sowing the Scotch pine is also recommended.

6. *Proposal for establishing a Flower School, or Florists' Society, for the Instruction of Young Men in Floriculture, to be connected with the Gardener's Institution for the Instruction of Young Men in Botany, Chemistry, and in the Science of Gardening generally.*
— 7. *Notes on the Meeting of March 11. 1827.*

8. *On the Horticulture of Erfurth.*

This paper is chiefly of historical interest, and will be made use of in a future edition of our *Encyclopædia of Gardening*.

9. *On Quercus coccinea and Q. rubra.* By M. Schoch, Head-Gardener at Worlitz.

The first of these trees has been known for upwards of fifty years in the park at Worlitz; and specimens are there to be found upwards of 100 ft. in height. There are also four distinct varieties of the species *coccinea*, differing in the colour of their leaves, and in their greater or less productiveness of acorns. All of them are remarkably ornamental, from the deep red of their very late falling leaves, especially in autumn, and when the trees appear among the dark foliage of pines. The timber is extremely firm and tough; and so suitable for furniture, that, when varnished, it becomes as dark as mahogany. *Quercus rubra* does not form so large or so handsome a tree as the scarlet oak; but it is still very beautiful, and deserves a place in every plantation. It requires rather a moist soil.

10. *On the Culture of Heaths.* — 11. *Report on the Gardener's Institution.* [See *Gard. Mag.*, Vol. III. p. 93.]

12. *Notice of certain Plantations made at Harbke.*

These plantations are of from fifty to seventy years' standing, and some of the trees produce a good many seeds. A purple beech produces 20 lbs. of mast yearly, which sells at 2 dollars (9s.) per lb. The tree is nearly 70 ft. high, $2\frac{1}{2}$ ft. in diameter about 1 ft. from the ground, and has been planted 57 years. [The high price at which the seeds of the purple beech sell is, probably, on account of its being a fact that about half the seedling plants from the purple-leaved beech will also be purple-leaved. — *J. D.*] A *Salisbùria adiantifolia*, of seventy years of age, flowered for the first time six years ago; but, of course, only produced male blossoms. It is only about 20 ft. high, and its trunk is not more than 1 ft. in diameter. [It may be worth the recollection of such of our readers as may desire to possess the female *Salisbùria*, that a plant of this sex exists in the king's botanic garden at Kew, and that grafts of it take freely on the male plant. — *J. D.*] There are specimens of *Pópulus balsamífera*, *álba*, *trémula*, *nígra*, and *itálica* [*acladésca Lindl.*], ninety years of age, from 70 ft. to 80 ft. high, with trunks 3 ft. in diameter, which have produced no seed. *P. itálica* [*acladésca Lindl.*] grows from 100 ft. to 120 ft. high, and 4, 5, and 6 ft. in diameter. *Tília álba* seeds freely, as do a number of other trees. The whole are the property of Count Weltheim, whose grandfather was one of the first to introduce hardy exotic trees and shrubs into Germany, about the middle of the last century. The ground occupied by these trees is upwards of 400 acres, over which they are scattered in the manner of an English park. Harbke is near Helmstadt, a town in the states of Brunswick; and we recommend such of our readers as are likely to be in that part of Germany to pay it a visit.

13. *Notes on what passed at a Meeting of the Society, held April 8. 1827.*

M. Bosse finds that the germination of seeds is accelerated by moistening them with the malic acid; and also that covering seeds with the pulp of rotten apples causes them to germinate sooner than usual.

14. *On the Use of Chloride of Lime in Agriculture.*

Unless spread very thin, it will do harm: spread thin, and intimately mixed with the soil, when the latter is in a dry state, its effects are similar to those of the common carbonate of lime.

15. *On manuring Fruit Trees.*

Some trees over-manured having died, a prejudice was created against the practice; and this short paper, which is chiefly a quotation from Christ, is to show that it is useful in moderation.

16. *Notes on the Botanic Garden of the Prince de Salm-Dyck, with some Ideas on private Botanic Gardens in general.* By M. Funke, Garden-Director at Salm-Dyck.

M. Funke recommends private persons who form botanic gardens to set out with some definite object in view; and this, he thinks, ought to be the cultivation of only one or two families, such as *Caméllia*, *Aster*, *Erica*, *Ròsa*, &c. This, he says, would enable each garden to excel in some one particular thing; and he cites, as examples, the garden of Herrenhausen, near Hanover, which is celebrated for ericas; that of the Pfaueninsel, for georginas; that of the seedsman Dreysig, near Erfurt, for stocks, &c. By this species of what he calls monocultural gardens, he says, we should produce more monographical botanists, such as Willdenow, Decandolle, Haworth, &c. A general collection of plants, he thinks, is only necessary in those gardens which are kept for public instruction. The monocultural garden of Salm-Dyck, we are informed, was, from the first, intended to be devoted to only two or three orders and families of plants; and, in consequence of confining itself to certain genera of succulents, it has now the finest collection of them in the world. The genus *Aloë* in that garden consists of 121 species and 50 varieties; among which are plants of the *Aloë ferox* and *abyssínica*, 8 ft. high, which attract the attention of all strangers. There are 17 species and varieties of *Agave*, 13 of *Yucca*, 33 of *Crássula*, 18 of *Sempervivum*, 10 of *Cacàlia*, 40 of *Euphórbia*. Of the *Cácteæ*, there are 10 *Mammillàriæ*, 12 *Melocácti*, 83 *Cèrei*, 5 *Rhip-sáldes*, 3 *Epiphýlla*, 4 *Peréskia*, and 45 *Opúntiæ*. Of *Mesembryánthemum* it contains 228 species and 46 varieties, and 99 *Stapèliæ*. The above-mentioned sorts increase from year to year; and make, with the addition of the *Ficus* and *Scitamíneæ*, the families which are cultivated in houses. In the open ground, the collections of *Rosàceæ*, *Coníferæ*, and *Leguminòsæ* are very perfect, and are grouped systematically round the castle. *Irídeæ*, *Labiàtæ*, *Ranunculàceæ*, and the genus *Pædònia* of which there are at present 80 species and varieties, are also cultivated. Though the botanic garden at Salm-Dyck is confined to the orders and families mentioned, yet, in the pleasure-ground and park scenery, all the more ordinary, and even the more rare and expensive, showy flowers, shrubs, and trees, are introduced.

17. *On Pinus Stròbus and Cuprésus thyòides.* By M. Schoch, Head-Gardener at Worlitz.

The Weymouth pine grows to the height of about 60 ft. at Worlitz, and will live there for various periods between twenty and seventy years. It dies soonest in poor dry soil. The wood is of little use, either as timber or fuel. *Cuprésus thyòides*, the white cedar of the Americans, is one of the handsomest trees at Worlitz. There are specimens there from 70 to 80 ft. high, though of not more than fifty years' standing, and growing in very middling soil. The greatest cold does no injury to this tree. The wood is very light, and it is fragrant and durable. [The white cedar is to be obtained in the English nurseries; but, owing, as I suppose, to its growing more slowly, and less compactly, than the red cedar of the Americans, *Juníperus virginiana* L., it is far less often asked for, or met with on lawns or among other decorative applications of shrubs. — J. D.]

18. *To preserve Grapes for the Table during the Winter Months, which have been ripened in the open Air.*

In the spring, before the buds have begun to swell, take a healthy well-ripened shoot of the preceding year, and draw it up through the bottom hole of a flower-pot of about 15 in. in diameter; then fill the pot with rich soil, and cover both the soil and the outside of the pot with moss, to keep in the moisture. Water now and then, according to the season. By the end of August, cut the shoot half through, just below the pot, so as to increase the number of roots, which will be formed about this time in the soil contained in the pot. In the course of the month of October, according to the season, cut the shoot quite through, and remove the pot, with the vine, laden with from twelve to twenty bunches of fruit, to a dry airy room, with a northern exposure; here water occasionally, till the leaves drop off, but no longer. Thus treated, the fruit will keep good on the vine till the end of February, preserving its natural flavour. The best sort for this purpose is the white sweetwater.

19. *On the Culture of Hibíscus attenuàtus of Bosse.*

This superb species, of which a splendid quarto coloured figure is presented, is some very near ally of the beautiful *Hibíscus palústris*, already in British collections, and of which mention is made in p. 13. Its herbaceous stem is from 5 to 7 ft. high; its leaves are smooth and elliptic, but attenuated (whence the specific epithet) into a long acuminate point. The flowers are pedunculate, and placed one

in an axil; the corolla is 3 in. long, and 5 in. across, and is of a lovely rosy hue. This beautiful plant can scarcely be propagated but by seed. Being herbaceous, it dies down to the soil every year; it should be kept dry, and free from frost during the winter, and repotted in light rich soil, mixed with river sand, in the spring. It should be placed in a frame, and abundantly watered during summer; but in autumn, when the plant begins to lose its leaves, watering must be gradually left off, till it is in a state to have the stem cut over, and the pot containing the root placed in the backshed of a stove.

20. to 24. *Notice of the Anniversary Dinner held on Sunday, June 17.; of the State of the Society's pecuniary Affairs; and of the Prizes given, or to be given, &c.*

25. *Report on a Plant of Cÿcas revolùta, a Female, which had blossomed in the Garden of Count Harrach at Bruck on Leithe.* By M. Lubeck, Head-Gardener at Bruck.

This plant, which had been in the same tub for upwards of twenty years, was found not only to have sent its roots through the bottom of the tub, but 3 ft. into the stump of an old tree on which it had been placed, to raise it a little nearer the light. It stood in a stove, had not been shifted for many years, and grew very vigorously. At last it produced its female flowers, and ripened fruits, consisting of a dry fleshy substance, with a thin and beautiful red skin, covered with a curly wool. The number of the fruit was about a thousand, and each contained a stone, or nut; but without a kernel, in consequence of the want of fecundation. [The female *Cÿcas revolùta* has fruited also in a stove, at Wentworth House, near Rotherham, Yorkshire.—*J. D.*]

26. *Notice of what took place at the Meeting held May 6. 1827.*

Grass land in the neighbourhood of the Rhine is improved by covering it to the depth of 2 in. or 3 in. with loamy soil.

27. *On the Horticulture of Venice.*

The principal melons are, the Malamocesini, easily known by the stem, being from 2 to 3 in. thick, and very knobby; the Cantaloups, with yellowish or whitish flesh; the Rham-paghini, which climb on trees and shrubs, and have their fruit closely covered with a whitish net; and the Bucharì (Bucharian melon), much cultivated on the islands of the Levant. These latter melons are of an elliptic form; their skin is smooth, and of a whitish yellow; the flesh is sugary, of a white colour; and, in the centre, where the seeds are contained, it is hollow. They are sometimes 1½ ft. in length,

and several pounds in weight; their principal merit, however, is, that they will remain good till Christmas, if kept in a dry and cool place. It is remarkable, that pieces of this very sweet fruit become intensely bitter when rotten. The seeds of the melons are generally put in good wine a short time before they are sown, which is done in April. Holes of 1½ ft. in diameter are made, 5 ft. apart; they are nearly filled with dung; and five or six seeds are sown in each, and covered with light soil. Two of the strongest plants only are left after they come up, and during their growth the most luxuriant shoots are cut out. Particular attention must be paid to observe the time of ripening of the fruit, which generally occurs at mid-day, and is known by the aromatic smell thrown out. The melons must then be cut, and kept in a cool dry place, as they lose their flavour entirely when left a few hours on the plant after their ripening. Not only the flesh of these melons is employed for food, but also the seeds, which, when bruised, and put into water with sugar, make a very agreeable liquid (*semuda*). The water-melons are also very extensively cultivated, much in the same way as the others. The seeds of the common sort are black, and those of the better variety (*Angurie zuccarine*) brownish yellow, with black spots. The fruit weighs from 10 lbs. to 50 lbs.; and a criterion of its ripeness is, when, on being struck, it gives a hollow sound; or when it cracks on being squeezed. Cucumbers are cultivated, but not much esteemed. Pumpkins are principal articles in Venetian horticulture; and several, particularly *Cucúrbita Melópepo* and *moschàta Duchesne*, are grown to great perfection: the last of these sometimes attains from 3 to 4 ft. in length, and 100 lbs. in weight. *Solànum Melongèna* and *Lycopèrsicum*, artichokes, carrots, radishes, spinach, and purple broccoli, are very fine; cauliflower, and several species of asparagus which are there used, are plentiful; but kohl-rabi and common winter cabbage are not known. Celery grows wild near the sea. Fennel forms an eatable bulb above the root, for which it is much cultivated, as well as for its aromatic seeds. [See Spence's *Notes on Italian Gardening*, p. 267.] Lettuces are used only when young plants; they never form a head, in consequence of the heat of the climate.

28. *Notices, &c.* — 29. *On planting Trees by Roadsides and in Hedgerows.*

30. *On planting Fruit Trees by the Roadside from Grünberg to Masserwitz.*

The number of plants was 3671; chiefly apples, and sour

cherries; the latter, no doubt, with a view to kirschwasser (see p. 182.).

31. *On the Propagation of Heaths.* By M. Faldermann, Head-Gardener in the Botanic Garden at Petersburg. — 32. *Notices, &c.*

33. *Notice of the Growth of A'lnus glutinòsa in light sandy Soil.*

It appears to grow more rapidly than birch in the same situation.

34. *Remarks on Answers to Prize Questions.*

Flower-seeds, when a few years old, are said to produce more double flowers than those which are sown the year after their ripening.

35. *Notices, &c.*

The wood of the horsechestnut makes very durable stakes for vines.

36. to 39. *Notices and Papers of local Interest.*

40. *On the Culture of the Melon.* By M. Ebers, Market-Gardener, Berlin.

Seeds ten years old are preferred: they are sown in February, and the plants are several times transplanted in a moderately warm frame, before they are put into a hot frame for fruiting. This is done when the shoots are about a foot long, and they are then shortened to three eyes. The succeeding shoots produced by those so shortened will flower abundantly; and, during their flowering, air must be freely given, otherwise they will not set well. Water-melons must not have their shoots shortened; and, when swelling their fruit, they require more water than the others.

41. *On forcing Asparagus.*

We are informed in this paper, that the *haut-gourmands* of Berlin prefer green asparagus during winter, and blanched asparagus during spring.

42. *Extracts from the Speech of Dr. Mitchell to the New-York Horticultural Society.*

43. *On raising Ferns from Seeds.* By M. Seitz, Botanic Gardener at Munich.

The seeds were formerly sown by him much in the same way as is usually practised with other very small seeds; they were sown on the surface of heath soil in pots, and moistened through the bottom hole from a vessel filled with water, in which they were occasionally placed; they were kept in the tan-pit of a stove, and each pot, during the day, was covered

with a piece of glass. In this way they grew tolerably well; but M. Seitz soon found that this method was attended by many disadvantages, to which very small seeds, and particularly those of ferns, are subject. He therefore procured a porous kind of stone, called tophus, which he divided into flat pieces of from 3 to 4 in. in diameter, and 2 to 3 in. in height; after being cleaned and washed, these pieces were covered with well-sifted soil, which was partly squeezed into the pores of the stone, to the thickness of two or three lines. The seeds were then sown on the surface, and the stone slightly immersed in a basin of water, when moisture was required. They were kept in a stove on a tan-pit, and glass put over them. In the mornings and evenings the sun was allowed to act upon them; but during the rest of the day they were well shaded. Regular temperature, and a moist atmosphere, were given, and the glasses were taken away during the night. This mode of treatment succeeded so well, that in about twelve days the germination was visible; and after a month's time the young plants were fit for transplanting into small pots. By this method the growth of the plants was not interrupted by worms, different mosses, or any of the other evils which generally occur when ferns are sown in the first-mentioned way; but the regular application of moisture, and the even temperature to which the stone was subjected, occasioned a vigorous growth. The best time for sowing ferns is from February to May; but they are not propagated by seeds alone, and many species may be increased by separating the fronds: a few may also be increased from knots, which detach themselves from the mother plant, and soon strike root. [We may mention *Woodwárdia radicans Swz.*, and *Aspídium bulbíferum Swz.*, as increasing by these frond-borne deciduous buds. — *J. D.*] The soil which M. Seitz uses to grow his ferns is heath or leaf mould, mixed with sand; and for hardy plants he approves of adding one fifth part loam. He plants some in the hollow stems of oaks, birches, and lime trees, which he considers not only proper to their nature, but also to present a true picture of the tropical world of plants. The situation for these ferns in the open air should be shaded, like that in the houses; and, if possible, be near the water, where they may be syringed during dry weather.

44. *On the Construction of the Aquarium in the Botanic Garden at Munich.* By M. Seitz. [See Hort. Trans., vol. iv. p. 395., and Encyc. of Gard.]

45. *On an improved Mode of heating Hot-houses, practised by M. Seidel at Dresden.*

Beds of sand are heated by flues placed in a vault underneath, and the pots are either sunk in the sand, or placed on it, according to their respective natures and conditions.

46. to 52. are *Notices, Extracts, &c., of local Interest*, and complete the volume.

ART. IV. *Catalogue of Works on Gardening, Agriculture, Botany, Rural Architecture, &c., lately published, with some Account of those considered the most interesting.*

BRITAIN.

RILEY, W. E.: Remarks on the Importation, and Result of the Introduction, of the Cachemire and Angora Goats into France; and the extraordinary Properties of the new Race, Cachemire-Angora; with its Capability of also rendering the Common Goat of value to the Colonists of New South Wales and Van Diemen's Land. Pamph. 8vo. London, 1832.

A great variety of information is here brought together on the subject of the Angora goat, its introduction into France, to England (at Weald Hall in Essex), and of an attempt to carry it out to Australia. Mr. Riley made two journeys to Paris, and each time brought over several of the goats; which we had the pleasure of seeing in perfect health, in April last, and which have been subsequently shipped to Sydney.

The Cashmere Shawl Goat has been successfully introduced into England by C. T. Tower, Esq., of Weald Hall, Essex; and as that gentleman, by this time, must have some of his flock to dispose of, we think their introduction among cottagers, for their wool and also (as suggested Vol. V p. 532.) for their milk, a fair subject for some of our female readers to speculate on. This variety of the common goat (or, probably, it may be a distinct species) is a fine-looking animal, and would be very ornamentai in a park, on a ruin, on the side of a rock, or in a churchyard. It would also be very pleasant to have a home-made Cashmere shawl. We shall, therefore, give all the information we can on the subject, from Mr. Tower's account, as published in the last volume (xlvi.) of the *Transactions of the Society of Arts*. The Cashmere goat was brought from Persia to France during the time of Napoleon, and under his patronage, by the celebrated M. Terneaux. In 1823, Mr. Tower, happening at that time to be in Paris, purchased four of them, two males and two females, and succeeded in conveying them safely to his residence in Essex. The soil of the park at Weald Hall, where they have been kept ever since, is moist, and the situation is much exposed. The animals have, nevertheless, continued in health, and multiplied rapidly; so that his present flock consists of twenty-seven, including the four original ones. Of these latter, a polled female, which was old when purchased by him, has every year produced at least one kid, and has twice had twins. Those individuals of which the horns cross are in Persia esteemed the best; and one of Mr. Tower's last year's kids has this peculiarity. They show no impatience of cold, and are very healthy; requiring only the occasional shelter of a shed in very rough weather. In spring, summer, and autumn they graze like sheep; and, during winter, have been fed with hay, and refuse vegetables from the garden; but their

favourite food is gorse (*Ulex europæa*), which they devour eagerly, without being annoyed by its prickles. They damage young plantations, but not more than other goats or deer will do. They breed very early: three of Mr. Tower's goats this year produced kids before they were themselves a twelvemonth old. A few produce brown wool; but that of far the greater proportion of the goats is white, and this latter is more valuable than the other. The coat is a mixture of long coarse hair and of short fine wool: this latter begins to be loose early in April; and is collected, easily and expeditiously, by combing the animals two or three times with such a comb as is used for horses' manes. A good deal of the long hair comes off at the same time, but the manufacturer has found no difficulty in separating it. The produce of a male is about 4 oz., and of a female 2 oz.: 2 lbs. of wool, as it comes off the goat's back, may be estimated to make one shawl 54 in. square. It will, therefore, require ten goats, male and female, to furnish materials for one shawl. Mr. Tower has this year had three shawls made of his wool, one of which was examined by the committee of manufacturers. The yarn was spun by Messrs. Pease of Darlington, and was woven by Messrs. Miller and Sons of Paisley. Mr. Tower's shawl was compared with one made in Scotland, of French shawl-goat wool, to which it was evidently far superior. It was also compared with a shawl of M. Terneaux's own make; and was considered by very competent judges to be superior to this also. (*Trans. Soc. Arts*, vol. xlvi., as quoted in *Ency. of Agr.*, 2d edit. § 7340.)

Mr. Tower's goats were visited by Mr. Riley this present summer, and he declares them to be the most interesting specimens of the pure breed he has ever seen. The flock, consisting, in 1823, of two bucks and two does, now (1832) consists of 51 animals. Mr. Riley found them "grazing promiscuously with other stock in the park, and appearing extremely docile. The climate of England renders it necessary that, at night, they should be protected in sheds; and, in winter, fed with hay," &c. "The down was at this time taking from them by a girl, with a common horse-comb; and, on comparing it with some specimens I had procured in France, received through Russia, I found not the slightest degeneration: but, on the contrary, from its very clean state, and the small proportion of hair, I should say, it would realise in Paris a much higher price than any I had seen. Mr. Tower has had some shawls made from the produce of his flock, one of which he presented to his late Majesty. It was greatly admired, and considered to rival those of Cachemire. Mr. Tower states that his flock produces an average of $2\frac{1}{3}$ oz. of down annually from each animal." (p. 42.)

FRANCE.

Poiteau and Vilmorin: Le Bon Jardinier: Almanach pour l'Année 1832.
Paris, 12mo.

We are here presented with an entirely new edition of this most valuable work, which, for a resident in France, forms a complete encyclopædia of garden culture. We have spoken of previous editions of the same work highly, and more at length (Vol. II. p. 52.).

Jacquin, M., sen., Member of many French and Foreign Horticultural Societies: Monographie Complète du Mèlon. 8vo. Paris, 1832.

This work is to be completed in six numbers, each of which is to consist of two sheets of letterpress, and of five or six plates of coloured engravings. The price of each number is 9 frs. or 6 frs., according to the paper. The writer introduces his subject by stating that the melon is not cultivated in the private gardens of the French gentry so perfectly, so generally, or so successfully, as it may be. The cause of this defect he attributes to a mistaken devotion to economy; many of the French proprietors

conceiving it cheaper to purchase their melons in the markets, than to supply their gardeners with the requisite means to produce them in their gardens; and that even those who have them grown at home, acting on this parsimonious feeling, are much too niggardly in the conveniences they place at their gardeners' disposal. One object of M. Jacquin's monograph is to show that the impression which the French gentry entertain is an erroneous one; and, consequently, to induce them to apply their best patronage to the promotion of the culture of this most estimable fruit. When the work is completed, we shall be able to estimate its value as a monograph, and to give a more detailed opinion of it to our readers.

AMERICA.

Anon.: Our Neighbourhood: or, Letters on Horticulture and Natural Phenomena. 8vo. New York, Bliss, 1831.

The object of these letters is to excite a taste for rural pursuits and especially gardening. The letters are dated, and enter into details of what is going on in the garden and farm of the writer, and in other gardens and farms in the neighbourhood, at the time they are written. So far the work may be considered almost an American gardener's calendar; but, in addition, we have remarks on natural phenomena, on every department of natural history, and, in short, on almost every subject: there is even a love story. The author shows a slight general knowledge of the rural economy both of Britain and America, and some acquaintance with the natural history literature of both countries. The writer assumes the character of a man, but is, in all probability, a woman.

The book has a particular charm, from the correct and detailed view which it gives of country life in a newly settled state; and, if it could be read by the intelligent part of the sons and daughters of farmers in Britain, it would tempt many of them to emigrate.

Proceedings of the Pennsylvania Agricultural Society, at their Third Annual Meeting, with the Address delivered by William Darlington, M.D. 8vo, pp. 24. Philadelphia, 1825.

Although the *talk of this Meeting was of bullocks*, it was sensible, philosophic, and in good taste; if we may judge from the address of Dr. Darlington, who was before known to us by an excellent *Flora of West Chester*, which we can recommend to those of our readers who are anxious to trace the range of some of our British plants in the United States. — ☞

ART. V. *Floricultural and Botanical Notices of new Plants, and of old Plants of Interest, supplementary to the latest Editions of the "Encyclopædia of Plants," and of the "Hortus Britannicus."*

Curtis's Botanical Magazine; each monthly Number containing eight plates; 3s. 6d. coloured, 3s. plain. Edited by Dr. Hooker, King's Professor of Botany in the University of Glasgow.

Edwards's Botanical Register; each monthly Number containing eight plates; 4s. coloured, 3s. plain. Edited by John Lindley, Esq. F.R.S., Professor of Botany in the London University.

Sweet's British Flower-Garden; each monthly Number containing four plates; 3s. coloured, 2s. 3d. plain. Edited by Robert Sweet, F.L.S., author of several botanical works.

Loddiges's Botanical Cabinet; each monthly Number containing ten plates; 5s. coloured, 2s. 6d. partly coloured. Edited by Messrs. Loddiges.

The reader will find the few abbreviations used in the following extracts explained in p. 12.

III. *Ranunculaceæ*. § *Helleboreæ*.

Delphinium speciosum is figured in the *Bot. Reg.* for June, t. 1503. It is "a hardy and handsome perennial, native to high elevations of the Caucasus." It produces its large deep blue blossoms, from June to September, and seems a very desirable species for decorating the hardy flower-garden.

XXII. *Ternströmiaceæ*.

2037. *THEA* 18160 *viridis*
2 *latifolia* B.C. broad-leaved ❸ or 4 f.n W China 1825? C p.1 Bot. cab. 1828

It is surprising, that in plants so much cultivated as the teas are in China, no more varieties have yet been noticed. The above one was introduced, some years ago, by the late Mr. Bassington. It is principally distinguished by its leaf being so much broader than the ordinary kind; the flowers differ but slightly. (*Bot. Cab.*, July.)

2038. *CAMELLIA* 18166 *japonica*
Reevesiana Lindl. Reeves's ❸ or 4 spl 10 sp C.Wsh China 1829? I 1p Bot. reg. 1501

"This is certainly one of the most striking camellias hitherto imported, its richness of colour far surpassing any that we have yet seen." *Camellia japonica Reevesiana* is published from the nursery of Mr. Tate, who imported the plant from China, and who "states that the flowers are very variable." The foliage has a remarkably curled appearance. This variety is named in compliment to Mr. Reeves, "to whom this country is under the greatest obligations for the zeal and liberality with which he devoted himself, during a long residence in China, to the collection and transmission to England of all [he could procure] that is rare, beautiful, or useful, in the flora of the celestial empire." (*Bot. Reg.*, June.)

XLV. *Grossulacæ*.

719. *RIBES*.
5928a *speciosum* Ph. showy ❸ or 5 my.jn. C California 1829. C co Sw.fl.gar.2 s.149
stamineum Smith in Rees's Cyclop. and *Dec. Prod.* 3. 477., and also *speciosum* *Dec. Prod.* 3. 478.

An especially showy species, having the entire habits of the gooseberry, yet vying in the form and brilliancy of its flowers with the elegant *Fuchsia*. A single plant was raised by A. B. Lambert, Esq., in 1829. The plant was, shortly after having been raised, planted in the open ground, where it is found to thrive luxuriantly, it being now (June, 1832) a large bush, five feet in height. It blossomed, for the first time, in the beginning of May, 1832, and continued in flower for more than six weeks. Its profusion of large, crimson, glittering blossoms, contrasted with its bright green glossy leaves, renders it one of the most beautiful objects imaginable." (*Mr. David Don*, in *Sweet's Flower Garden*, July.)

Specimens of this fuchsia-flowered gooseberry were exhibited at a Meeting of the Linnæan Society, held on June 19., from Mr. Lambert's garden at Boyton House, Wilts; and a description of the plant, by Mr. D. Don, was read. Mr. Don presents the following concise and expressive specific character of *R. speciosum*:—Branches bristly; prickles three together; leaves smooth; calyxes four-cleft and tubular; stamens and pointal projecting far beyond the flower; berries hispid.

LVI. *Myrtacæ*. § *Euleptospermæ*.

Bæckia saxicola Cun., given in the Supplement to the *Hortus Britannicus*, p. 476., is figured in the *Bot. Mag.* for June, t. 3160., where it is stated, from Mr. Cunningham, that this neat little white-flowered shrub is prostrate on the bare granite rocks which it inhabits on the south-west coast of Australia; but that, under cultivation, at Kew, with more nutritive food, it has become a perfectly erect shrub. At Kew it flowers in March. (*Bot. Mag.*, June.)

Myrtacæ. § *Lecythidacæ*. *Couroupita* (the name of the plant in Guiana) *guianensis*, the Guiana *Couroupita*, or cannon-ball tree, is elaborately

figured and described in the *Botanical Magazine* for June, t. 3158. and 3159. It is a tree from 50 ft. to 60 ft. high, and with a trunk often more than two feet in diameter: the wood is soft. The branches are spreading, and covered with a smooth bark; the leaves, which are alternate, from 8 in. to 10 in. long, and broadly lanceolate, are the most copious at the extremities of the branches. The racemes of flowers are from 1 ft. to 3 ft. in length; produced on the former year's branches, and upon different parts of the trunk, bearing a great many, sometimes a hundred, flowers, of a very large size, and very splendid in colour; and, moreover, are endowed with a most delicious odour. The flower-buds, shortly before expanding, are of about the size of a medlar: the expanded flowers, according to the figure, are from 4 in. to 5 in. across. They are yellowish on the outside, with a tinge of red crimson-lilac within, and spread out horizontally. The petals to each flower are six, rarely seven, leathery in texture, unequal, somewhat orbicular, and much waved and concave. The details of the structure, and arrangement of the stamens and pistils, seed-vessel and seeds, are highly interesting in a botanical point of view; and for these we refer the reader to the original article, just remarking that it presents a most extraordinary arrangement of its stamens, these being seated on the face of a fleshy strap-like disk towards its extremity, which grows out from beside the germen, and would project the stamens quite away from the stigma, but that a fold in the centre of the stamen-bearing strap brings the stamens in direct contact with the surface of the stigma. Although a raceme consists of 50 to 100 flowers, it produces but one or two fruits. The fruit is round, reddish, rough to the touch, and from 4 in. to 8 in. in diameter, and, from its size and form, has procured for the tree the name of the cannon-ball tree. The fallen pericarps, or fruits, which strew the ground beneath this tree, in Cayenne, and exhibit the scar or hole by which they were attached to the fruit-stalk, so nearly resemble the bomb-shell, that one might easily, at first sight, imagine that a company of artillery had bivouacked in its shade. The fruit, or pericarp, is occupied internally by pulp, which, when ripe, is of the colour of wine lees, and through which are scattered an indeterminate number of seeds, each larger than a pea, and invested with a leathery membrane, which is woolly externally. The shell of the fruit is used, in South America, for domestic purposes, as the calabash. The pulp contains sugar; gum; malic, citric, and tartaric acids; and is employed to afford a refreshing drink in fevers; but, in the perfectly ripe state, it exceeds whatever is filthy, stinking, and abominable in nature; yet the scent is remarkably vinous, and so durable that the Rev. L. Guilding, on examining some portions of the fruit that had been preserved in rum for two or three years, found the native odour of the plant so strong, as to render a continuance in the apartment almost insupportable. Insects revel in this disgusting and putrid pulp, Coleóptera and Forficulæ (ear-wigs) feed upon it, while the Formicæ (ants) find a shelter in the hollow of the shells. Dr. Hooker, for much of the material out of which he has elaborated the luminous figures and descriptions of this tree and its parts, professes himself indebted to his friend the Rev. Lansdown Guilding of St. Vincent. It appears that a living specimen of the tree does not exist in any European collection of plants; and Dr. Hooker despairs of seeing it flourish in any region beyond the tropics. The tree is an inhabitant, and one of the greatest ornaments, of the dense forests of Cayenne, where it flowers at all seasons of the year, and where its trunk and branches are not unfrequently concealed from view by an investing mass of the Spanish longbeard (*Tillandsia usneoides* L.). From Cayenne, the tree has been introduced into the Island of St. Vincent, Dr. Hooker believes, by Dr. Anderson. (*Bot. Mag.*, June.)

At page 241. of the current volume, Dr. Hamilton informs us that Pita

is a term indiscriminately applied, in South America, to all plants yielding a fibrous substance, and especially to plants of the pine-apple family, or *Bromeliæceæ*, as the leaves of these plants are eminently endowed with fibre. As the beautiful tree just described is frequently more or less invested with the *Tillandsia usneoides* L., and as this plant is included in the fibrous-leaved family of *Bromeliæceæ*, it is not unfair to infer the possibility of its being one of the plants called pita in South America; and I have been led to this remark by the two terminal syllables of the native name of this tree, *Couroupita*, and the fact of the *tillandsia's* growing upon it.—*J. D.*

LXXVII. *Leguminosæ* § *Sophorææ*.

1246. CHOROZEMA.
10499a triangulære Lindl. 3-angled prickled $\text{✱} \sqcup$ or $\text{✱} \text{ap}$ S N.Holl. 1830. C s.p Bot. reg. 1513

Another of Mr. Knight's exquisite treasures, raised out of the stock of New Holland seeds purchased by him of Mr. Baxter. It is closely related to *C. nanum*, but Professor Lindley enumerates several points of specific distinctiveness: it is a delicate plant, and requires a very airy dry shelf in the green-house in winter. (*Bot. Reg.*, July.)

Professor Lindley adopts Smith's spelling of this generic name, and quotes Smith's etymon, which is as follows:—“*M. Labillardière* originally discovered this genus upon the south-west coast of New Holland, at the foot of the mountains, in a loamy soil, near the spot where, after having been tantalised with finding many salt springs, his party had just met with an ample supply of fresh water. This welcome refreshment, of which he speaks feelingly in his book, seems to have suggested a name for this genus. He called it *Chorozema*, evidently from *choros*, a dance, or joyous assembly, and *zema*, a drink, in allusion to the circumstance just mentioned.”

Leguminosæ § *Loteæ*.

1940. HOVEA.
17284a villôsa Lindl. shaggy $\text{✱} \sqcup$ el 3 ap Li N.Holl. 1829? C s.p Bot. reg. 1512

Figured from the nursery of Messrs. Rollisson of Tooting. It differs from *H. purpurea* Swt., its nearest relative, in being excessively shaggy, instead of being merely covered with a very short dense pubescence; the reticulations of the leaves are also much larger and more distinct in *H. villôsa* than in *H. purpurea*. (*Bot. Reg.*, July.) It seems a pleasing and desirable kind. Is not its affinity to *H. pannôsa* also very intimate?

CXXI. *Pittosporææ*.

679. PITTOSPORUM.
cornifolium Cun. Dogwood-lvd. $\text{✱} \sqcup$ cu 3 mr Br N.Zeal. 1827. C p Bot. mag. 3161

This is a curious, but not handsome, species. Mr. Cunningham met with it, in 1826, in dark humid woods, by the rivers in New Zealand, producing flowers in September, and ripe fruit about the close of the year. He uniformly found it growing parasitically on tufts of *Astelia* (*Astelia Bánksii*), and upon the trunks and branches of the larger timber trees, particularly upon the *kackatea*, or *Dacrydium taxifolium* of Lambert. (*Bot. Mag.*, June.)

CXXIV. *Tropæolææ*. That very elegant, perennial, herbaceous, green-house, climbing plant, *Tropæolum tricolorum*, is figured in the *Bot. Mag.* for July, t. 3169., where the following admirable etymon of the generic name is quoted from Smith:—“*Tropæolum*, from *tropaion*, a warlike trophy, from the shield-like leaves, and the brilliant flowers shaped like golden helmets, pierced through and through and stained with blood, which might very well justify such an allusion.”

CXLVI. *Galucineæ*. *Francòca* Cav. (Don Francisco Franco, a physician of Valencia, who flourished at the commencement of the sixteenth century. He was the author of several medical works, and an ardent cultivator and promoter of botany.) 8. 1. Sp. 3.

appendiculata *Cev.* appendicled ♀ Δ or 3 my.jn Ro.C Chiloe 1831. S p.1 Sw.fl.gar.2 s.151

A very ornamental, and therefore very desirable, novelty. It was raised at Low's Nursery, Clapton, from seeds collected by Mr. Anderson, near the port of San Carlos de Chiloe. Mr. Anderson accompanied Captain King, in the capacity of botanist, in his recent voyage of survey on the coasts of South America. *Francœa appendiculata* appears to succeed well in England, in the open border of a garden, where its tall clusters of rosy blossoms, marked with deep crimson, render it a conspicuous object. Two other species, *F. sonchifolia* *W.*, also with rosy blossoms, and *F. ramosa* *D. Don*, which has white flowers, have been recently introduced from seeds collected by Mr. Hugh Cuming, in Chile. (*Mr. D. Don*, in *Sweet's Flower-Garden*, July.) A plant of *Francœa appendiculata*, in full flower, was exhibited at the Linnæan Society's Meeting on June 19., from Low's Nursery, Clapton; and a description of it, by Mr. D. Don, was read.

CLVI. *Polygonæa*. *Coccoloba* (*kokkos* seed, and *lobos*, a lobe; from the lobed seed, not fruit as stated in *Hort. Brit.*) *pubescens* *L.* is figured in the *Bot. Mag.* for July, t. 3166. This is a plant of much interest in British stoves, on account of the very large size of its cordately based orbicular leaves, which sometimes attain to an expansion of two feet in diameter. I once saw a leaf almost of this size produced on the plant in the stove of the Cambridge Botanic Garden. This plant produced a single raceme of flowers, for the first time (and it had never been previously known to flower in Britain, although introduced in 1690), in the beginning of February, 1832: but, owing to the bad condition of the hothouse, which seldom allows of its retaining a temperature of more than a few degrees above 60°, none of the flowers appear to have expanded properly. Of them, however, Professor Henslow has availed himself as fully as he could, and contributed to the *Bot. Mag.* the result of his researches: these are of botanical rather than of gardening interest. According to Jacquin, the *Coccoloba pubescens* becomes an inelegant upright tree, between 60 ft. and 80 ft. high. It is a native of the West Indies, and very common in the mountain forests of Martinique. The wood is hard, heavy, deep red, and almost incorruptible. When used for posts, the part in the ground becomes as hard as stone. The fruit is said to be eatable. (*Bot. Mag.*, July.)

CLXX. *Ericæa* § *vivæ*.

4173. *ERICA*. § I. *Tubifloræ*.

dichromata *B.C.* two-coloured ■ □ or 3 aut.w Y.Pk C.G.H. 1800. C s.p *Bot. cab.* 1813

The flowers are beautiful, the tubular corols being pink at their base for about one third of their length, and the remainder yellow. The shrub is usually two feet high before it begins to flower. (*Bot. Cab.*, June.)

Tubifloræ.

verecunda *B.C.* ruddy-flwd ■ □ or 3 su.aut Ro C.G.H. 1820. C s.p *Bot. cab.* 1827

This, according to the figure, is quite an ornamental kind: its tubular red corols seem numerous produced, and have a pendulous direction. "It grows vigorously, and attains a considerable size." (*Bot. Cab.*, July.)

Ericæa § *Rhodoræca*.

In *Sweet's British Flower-Garden* for June, t. 148., the white-flowered tree rhododendron is figured from the Chelsea Botanic Garden. This has hitherto been named *Rhododendron arboreum* 2 *album*; but Mr. D. Don concurs with Mr. Sweet in considering it a perfectly distinct species, to which Mr. Sweet has applied the specific name of *album*; a name which cannot be retained, because previously occupied by the *R. album* of Pursh, the second species in both the *Hortus Britannicus* of Sweet and that of London. This white tree rhododendron, be the specific name hereafter agreed upon for it what it may, "differs from *R. arboreum* by its rigid

leathery leaves, and their rugged dark-green surface, and bright cinnamon or rusty colour underneath; it also differs essentially in the bracteas that surround the flowers being straight and erect, not reflexed, as in *R. arboreum*; but the most distinguishing character is, its bearing an appendage on every alternate filament, a little above the base, sometimes one on each side. (*Sweet's Flower-Garden*, June.)

CLXXI. *Epacrideæ*.

504. *E/PACRIS*.
variabilis B.C. variable ■ □ or 2 ja.f Pk N.S.W. 1829. C s.p Bot. cab. 1816

Messrs. Loddiges raised this, with several others, differing in form and colour of flowers, in 1829, from seeds sent home by Mr. MacLeay to Mr. Dyer, who kindly communicated the seeds to them. The picture represents it an ornamental species, as the pendulous tubular corols are thickly placed on the branches, and are of a pinkish colour. (*Bot. Cab.*, June.)

nivalis B.C. snowy-flwd ■ □ or 3 mr W N.Holl. 1829. C s.p Bot. cab. 1829

Raised from seeds presented to Messrs. Loddiges, in 1829, by H. M. Dyer, Esq. The plants, in two years, grew to the height of two feet, and flowered in great abundance in the month of March. (*Bot. Cab.*, July.)

Epacris onosmæflora is figured in the *Bot. Mag.*, July, t. 3168., and is stated to inhabit peaty bogs at Blackheath, on the Blue Mountains of New Holland, at an elevation of 3400 ft. above the sea's level. It beautifies the green-house with its blossoms in March.

Acrótriche ovalifolia is figured in the *Bot. Mag.* for July, t. 3171., where it is stated of it, "As an ornamental plant for the green-house, it cannot boast of much beauty, until the flowers are examined with a microscope, when the delicate structure of the corolla, the singular tuft of hairs at the extremity of the segments of the corolla, and the rich orange-coloured anthers, lying in the sinuses of those segments, become apparent." This species inhabits, at least as one situation, the exposed summits of sandy ridges in New Holland, and bears white drupaceous fruit. It may be added, that the subsides of the leaves of *Acrótriche cordata* are especially elegant objects, being scored lengthwise with parallel and alternate stripes of green and glaucous, ciliated at the margin, and tipped with a short prickle.

CLXXXVI. *Compósitæ* § *Astèreæ*. *Aster lævis* L. is figured in the *Botanical Register* for June, t. 1500., and there stated to differ from *A. cyaneus* (noticed in p. 349.), in being totally destitute of glaucousness; in having its leaves more acuminate, and rougher at their edge; in the radical leaves being narrower (these are either serrate or entire); and in having the involucre obconical, not campanulate, with the bases of their scales much less pale than the bases of those of *A. cyaneus*; and in the florets of the ray being of a pale blue colour.

Compósitæ § *Anthemideæ*. *Chrysanthemum indicum* var. plenum, the double yellow Indian chrysanthemum, is figured in the *Bot. Reg.* for June, t. 1502. This variety "is not much cultivated, because of its not flowering except after very hot and dry summers, such as that of 1831; but when its blossoms are produced they are extremely neat, and form a striking addition to the few flowers that December produces." (*Bot. Reg.*, June.)

CCXXI. *Labiatæ* § *Nepeteæ*. *Phlomis tuberosa* L. is figured in Maund's *Botanic Garden* for June, t. 360., where the following interesting speculation is offered on the tubers of this vigorous-growing and comparatively showy herbaceous perennial:—"The presence of these tubers does not seem to be of primary importance to the existence of the plant, it being furnished with an ample portion of fibrous roots from its crown, whence offsets, and consequently increase, are afforded. Its fibres descend deeply,

and mostly perpendicularly, into the earth; and at various distances, within 1 ft. of the surface, a tuber is formed on many of them, of the size of a small potato or less, not terminally, or principally so, as in the potato plant, but by the enlargement of the fibres at some distance from either extremity. It is a simple mass of alburnum, resembling in appearance the kernel of a cocoa nut, but softer, and of a taste rather bitter; which flavour is not reduced either by boiling or drying. It is probable that a regular supply of moisture, in accordance with the requirements of the plant, would altogether prevent their formation. We know that some species of grass which are strictly fibrous-rooted, particularly the *Phlèum pratense* L. [and, perhaps, the *Àvena elàtior* L., *Hórdeum bulbòsum* L., *Alopecùrus bulbòsus* L., *Phálaris bulbòsa* Cav., and *Phálaris nodòsa* Bieb.], produce tubers in situations where they are exposed to the occasional want of fluids necessary for their luxuriant or healthy increase. When suffering under such privations, it may be easily conceived that the stems and roots of a plant become less flexible; and its vessels, being constricted by drought, would be incapable, when subsequently supplied with a due portion of fluids, of ready and free dilatation. In this state, the fluids collected by the extremities of the roots may be prevented, by the rigidity of those parts near the surface of the earth, from freely ascending. At this point, an accumulation of the juices occurs; and, somewhat analogous to a tumour in an artery arising from dilatation, a tuber is produced. These tubers, gradually increasing, subsequently become reservoirs, to meet any deficiency of supply that may casually occur. Thus we see Infinite Wisdom make the very existence of a want the means of its remedy.”

“A proper distinction must be observed between such tubers as are mere reservoirs of unprepared fluids, and those which are depositories of elaborated juices from the plant, in which the vitality of a future individual of its species exists.” The above views merit the consideration of the young gardener; and, should *Phlòmis tuberòsa* L. not be one of the plants cultivated in the garden in which he is employed, I may mention *Orobùs tuberòsus* L., *Láthyrys tuberòsus* L., pæonies, and georginas, as plants possessing tubers, all, I believe, but certainly those of the georginas, destitute of buds or eyes; and *Àpìos tuberòsa* Man., the common potato, *Heliánthus tuberòsus*, and *Wedèlia áurea*, exemplifying tubers beset with buds. It may be well to examine if Mr. Maund’s theory will at all conduce to account for the granulations, or minute tubers, which are invariably strung on the fibres of every leguminous plant: the laburnum, the common false acacia, and the white clover, are familiar instances. — *J. D.*

CXXV. *Cordiàcææ.*

563. *CORDIA.*

grandiflora Lindl. large-flwd ♀ □ or ... au W S.Amer.? 1827. C 1.p Bot. reg. 149₁

A very fine species, with large white broadly funnel-shaped corollas, which now, it is feared, is not in this country. It flowered in 1828, in a stove in Lee’s Hammersmith Nursery. That it belongs to the genus *Cordia* is not positively known, for no specimens have been preserved, and consequently the semblances of the drawing have been the only guides to referring it to any genus. (*Bot. Reg.*, figured in May, described in June.)

MONOCOTYLEDONOUS PLANTS.

CCXXXVIII. *Amaryllidææ.*

933a. **AJAX* Sal. (*Narcissus* L.)

albicans Haw. whitish ♂ Δ or 1 ap W Spain ... O s.1 Sw.fl.gar.2.s.145

Beautiful and rare, but possessed by Mr. Ellicombe of Vicarage Bitton, near Bath, and Mr. Haworth of Chelsea. Mr. Sweet has seen it also “in other collections about London, introduced from Holland this year, under the name of *Narcissus moschàtus* ;” but the *N. moschàtus* of the Linnæan

herbarium, Mr. Sweet remarks, "is a very different plant." Mr. Haworth, in his *Monograph*, assigns to *A. albicans* the English name of "the greatest Spanish white." (*Flower-Garden*, June.)

937. EURYCLES.

Cunninghamii Lindl. Cunningham's $\frac{1}{2}$ [A] el 1 mr.ap W N.Holl. 1830. O p.1 Bot. reg. 1506

A very interesting bulbous plant, of the general appearance of which *Hemerocallis japonica* L., *Funkia subcordata* Spr., will give a pretty exact idea. The white flowers of the *Eurycles* are, however, smaller, fewer, and produced in an umbel; while those of *Funkia subcordata* are in a spike or raceme. The flowers of the *Eurycles* are neat and pretty, and its foliage beautiful; altogether, it is an elegant plant. It is figured from the nursery of Mr. Knight, who received it from New Holland of Mr. Baxter: at present it is extremely rare. Mr. Lindley states that *Eurycles* is derived from "*eurys*, broad, and *kleio*, to close up; in allusion to the dilated state of the [filaments of the] stamens, which close up, as it were, the opening of the tube of the perianthium." This etymon is here recorded, on account of its distinctness from that given in Loudon's *Encyclopædia of Plants and Hortus Britannicus*.

CCXXXIV. *Bromeliaceæ*.

957. BILLBERGIA.

7752a bicolor B.C. two-coloured $\frac{1}{2}$ [A] or $\frac{1}{2}$... Ro.B RioJan. 1829? Sk s.p Bot. cab. 1819

This species differs from *B. nudicaulis* in its obtuse petals, its much narrower leaf, and its spines being green in lieu of black; the leaves also are green at their base. It grows in the forests of Brazil, upon trees, rooting into the rough bark. The luxuriance of vegetation in that immense country is prodigious. In some parts the woods are wholly impenetrable, the very trunks of the trees almost touching each other, and the number of plants of this order (*Bromeliaceæ*), also of *Orchidææ*, ferns, and many others, growing upon them, is most astounding. The difficulty of access to them is so great, as almost to preclude the possibility of ever discovering the greater proportion of them. (*Bot. Cab.*, June.)

CCXXXIX. *Iridææ*.

123. TRITONIA.

odorata B.C. fragrant $\frac{1}{2}$ [A] or $\frac{1}{2}$ su Y C.G.H. 1829? O s.p Bot. cab. 1820

This "flowers early in the summer, and is very fragrant." Messrs. Loddiges "have preserved it safely in a narrow border, close to the wall, in the front of a stove, where the ground is scarcely ever frozen in winter, in which this, as well as most of the Cape plants of the same family, flowers, and grows much better than when potted, and kept in a greenhouse." (*Bot. Cab.*, June.)

Iris tuberosa, and intimately related *Species*. At p. 235. we, unnecessarily perhaps, bespoke the affection of our floricultural readers for that lovely spring flower, the *Iris tuberosa* L., and detailed the means by which it may be readily multiplied, and so cultivated as to blossom with satisfactory freedom every spring. As shown in p. 235., it appears this charming plant grows wild, both near Cork and Plymouth. Mr. Sweet, in his *Flower-Garden* for June, t. 146., figures another tuberous-rooted species, with quadrangular leaves, and describes a third, and suggests that even more than these exist, but all confounded under the name of *Iris tuberosa*; and that this confusion has arisen from "the leaf four-edged" having hitherto been taken as an absolute characteristic of *Iris tuberosa*, and all the irises possessing it having hitherto, in consequence, been referred to this name. That distinguished botanist, Mr. Salisbury, many years ago, proposed the restoration of Tournefort's genus *Hermodactylus* for the reception of the *Iris tuberosa*. *Hermodactylus*, from *Hermes*, *Mercury*, and *daktylos*, a finger, expressing the resemblance borne by the tubers of this plant to the human fingers. This genus and generic name Mr. Sweet has adopted, and the one new species which he figures and

describes, he denominates *Hermodáctylus longifólius*. That the species is distinct enough from *Iris tuberósa*, which Mr. Sweet denominates *Hermodáctylus bispáthæus* (passing by Salisbury's name of *H. tuberósus* in the *Hort. Trans.*, probably as deeming it not sufficiently distinctive, now that other tuberous species are known), there cannot be a question. It is possible, however, that questions will arise on the propriety of forming these species into a new genus; and, until these questions are affirmatively answered by the consent of a majority of botanists, we shall retain the species in the genus *Iris*.

142. IRIS.

1305a *longifolia Swt.* long-ld. ✕ Δ or $\frac{2}{3}$ ap P.Gsh Naples 1829. D It Sw.fl.gar.2.s.146

Iris longifolia has some of its radical leaves a yard or more in length, and but one flower in a spathe; *I. tuberósa* has much shorter leaves, and has two flowers in its spathe: these are the obvious points of difference, and there is a sufficiency of minor ones. Mr. Sweet's species of *Hermodáctylus*, then, are these:—1. *H. longifólius*, *Sw. Fl. Gar.* 2. s. 146. 2. *H. repens* (creeping-rooted), of which the *Iris tuberósa* of Sibthorp's *Flora Græca*, 1. 41.; of the *Magazine of Natural History*, vol. iv. p. 29., and *Gardener's Magazine*, vol. viii. p. 235., the cut in both these places having been copied from that in *Flora Græca*, 1. 41.; and of Redouté's *Liliacées*, t. 48., are synonyms. It will be remembered that, in p. 235., we remarked that the figure there (copied from that in *Flora Græca*) differed completely in its "scaly creeping sucker (propago) at its root," from the *Iris tuberósa* we had always known: the truth of this remark is now corroborated by the experience of Mr. Sweet; the *Iris tuberósa* we had all along previously known being his third and following species. 3. *H. bispáthæus*, of which the *Iris tuberósa* of *Bot. Mag.* 531., of Link's *Enumeratio*, and of Smith's *Herbarium*, are synonyms; as well as *Hermodáctylus tuberósus* of Salisbury, in *Hort. Trans.*, vol. i. p. 304. In addition to our remarks (Vol. VIII. p. 235.) on the culture of the last-named species, this observation by Salisbury may be of interest:—"In a border of deep rich loam, at Chapel Allerton, it flowered every year: at Mill Hill, on a dry gravel, it never flowered." It has again flowered finely, this spring, in the Bury Garden, under the treatment described p. 235.; and the plants from the wild station near Plymouth have, this spring, flowered in the Cambridge Botanic Garden. Should the specific distinctness of the three kinds above named become admitted, of which there is probably very little doubt, the geographical station of each species will then be desirable to be known. Salisbury says of *H. bispáthæus Swt.*, "it grows in the Peloponnesus;" but the fact of *H. repens* being the species figured in *Flora Græca*, excites a doubt whether Salisbury's habitat does not apply rather to *H. repens* than to *H. bispáthæus*. After all, may it not be purely by error that so peculiar a creeping-root shoot has been affixed to the plant figured in *Flora Græca*, 1. 41.? If it be by error, *H. repens* is in consequence a nonentity: nevertheless, should such be the case, *Hermodáctylus longifólius Swt.* and *H. bispáthæus Swt.* are without a doubt as satisfactorily distinct as any two species need to be.

The *Iris biflora* of Linnæus is published in Sweet's *Flower-Garden* for July, t. 152.; where numerous technical details respecting it, which will avail the studier of this genus, are presented: living plants of it are in the Chelsea Botanic Garden, and in the garden of Mr. Sweet. *Iris reticulata Bieb.* is figured in the *Bot. Cab.*, July, t. 1829. Its leaves appear not to attain a greater height than 6 in.; its flower is borne at 3 in. from the ground, and is large and highly beautiful. The species is yet rare in Britain.

CCXL. *Orchidæa* ♂ *Ophrydeæ*.

2490. HERMYPNIUM.

cordatum Lindl. heart-ld. $\frac{2}{3}$ Δ fra $\frac{2}{3}$ mr.n Ysh.G N.W.Af. S.W.E. 1830. D p.1 Bot

[mag. 3164

Habenaria cordata Hooker, Bot. mag. 3164.

This plant has no attractive beauty; but its small greenish flowers are highly fragrant, especially in the evening. It grows well in the green-house; but, when about to bloom, is benefited by a removal to a cool part of the stove. Professor Lindley appends to the description of this species numerous valuable remarks on its structure and that of allied plants: these appertain to systematic botany. (*Bot. Reg.*, July.) The exquisite fragrance in the evening, and by night, of the common two-leaved orchis of English woods, *Platanthera bifolia* Rich. has been already declared in Vol. VII. p. 203.

Orchideæ § *Vándææ* Lindley.

2537. MAXILLARIA.

viridis Lindl. green-sepated ♀ ☐ cu $\frac{1}{2}$ my G.P.Li Rio Jan. 1829? D p.r.w Bot. reg. 1510

The flower is radical, solitary, and globose; the sepals green; the petals purple; the lip lilac. The plant in the Horticultural Society's garden is rather a weak-growing one; requiring shade, much moisture to its leaves and little to its roots, together with a high temperature, and decayed vegetable mould. It seems to have no tendency to form those pseudobulbs which are generally so characteristic of the genus. (*Bot. Reg.*, July.)

CCXLVII. *Asphodelææ*.

1053. ORNITHOGALUM.

alliaceum B.C. Allium-like ♀ ◻ or $\frac{1}{2}$ au W Chile 1821. O s.l Bot. cab. 1818

Only two white blossoms are exhibited in the umbel figured, but this may be the effect of weakness. The plant was sent home in the beginning of 1821 (query 1831) by Mr. Cumming. Messrs. Loddiges have grown it in the green-house, in a mixture of loam, peat, and vegetable earth. (*Bot. Cab.*, June.)

1061. ASPHODELUS 8869 luteus.

2 sibiricus Lindl. Siberian ♀ ◻ or 2 ap.my Pa.Y Siberia 1829? D co Bot. reg. 1507

The seeds of this kind were received from Dr. Fischer, under the name of *A. sibiricus*. It differs from *A. luteus* in its dwarfer stature, earlier and paler flowers, more glaucous leaves, and shorter bracteas: Professor Lindley cannot, however, on these accounts, consider it more than a variety of that species. It is a perfectly hardy perennial, and requires to be treated precisely in the same way as *A. luteus*. (*Bot. Reg.*, July.)

ART. VI. *Literary Notices.*

OUTLINES of the First Principles of Horticulture, in one small volume, 18mo, are in preparation by John Lindley, Esq. A work which will be hailed with delight by every gardener throughout the world.

The Apiarian's Guide, containing Practical Directions for the Management of Bees upon the depriving System, is in preparation by J. H. Payne, of Bury St. Edmunds, author of "The Cottager's Guide, for the Management of his Bees," a work distributed gratuitously among cottagers by the Suffolk and Norfolk Apiarian Society. *The Apiarian's Guide*, the result of thirty years' experience, will comprise useful and authentic information relative to every department of apiarian science, and will render the most inexperienced in the art capable of managing his bees at a trifling expense, so as to obtain from them an annual supply of honey without destroying them, leaving a sufficient quantity for their support throughout the winter. Amongst other matter, an immediate remedy will be given for the sting. The author has under his care a stock of bees, a swarm of May 1831, which, in July of the same year, produced a glass of the finest honey weighing 19 $\frac{3}{4}$ lbs., leaving, at the same time, upwards of 30 lbs. in the hive; and it has already this year filled a glass of 10 lbs., and is now filling a box which will contain nearly the same quantity. The work is to be published by subscription.

MISCELLANEOUS INTELLIGENCE.

ART. I. *General Notices.*

EMIGRATION.—As we have lately been strongly recommending gardeners to emigrate to the United States, several persons have since sent us publications, with a view to show that the Canadas offer still greater advantages. We have looked over three of these works. The first is entitled *The Canadas, as they at present commend themselves to the Enterprise of Emigrants, &c.*, compiled from documents furnished by John Galt; by Andrew Picken. This work abounds with practical details, topographical, agricultural, and commercial, and must therefore be of very great value to those who are in doubt in what part of the country to settle. The next book is Pickering's *Emigrant's Guide*, 4th edition. In this work the author has given a comparative statement of the prospects held out by the United States and Upper Canada, as the best for British emigrants; and he endeavours to show the superior advantages of the latter country to farmers, farm-labourers, and the most useful description of tradesmen. We have little doubt he is correct; but, for gardeners, we should prefer the United States; because, there they have at least a chance of getting professional employment, in addition to the certainty of getting employment as common labourers. A third work is, *Statistical Sketches of Upper Canada, for the Use of Emigrants; by a Back-Woodsman*. This has the merit of being a concise and cheap work. The author prefers Canada to the United States, and principally because Canadian corn is admitted into both British and West Indian ports on more advantageous terms than that of America; and that the articles required for the consumption of the inhabitants, and British goods generally, pay one twelfth only of what they do in the ports of the United States. We admit the full weight of all these reasons; and, having recommended emigration to gardeners, have thought it our duty to state them.

Preserving the Purity of the Thames Water.—In our Fifth Volume, p. 690., we mentioned several plans for saving the manure at present carried into the Thames by the London sewers, and at the same time maintaining the purity of the water of the river. We have since seen a 4to pamphlet, entitled, *Outlines of several new Inventions for Maritime and Inland Purposes*, by John Martin, Esq., the celebrated artist, 4to, 1829, not published, containing a second plan for supplying London with pure water; and Ainger's plan for preserving the purity of the Thames, noticed in the *Mech. Mag.*, vol. xiv. p. 82. Mr. Martin had before proposed a plan, in a work not published, and of which we have never been able to see a copy, for supplying London with water from the river Colne, and this he considers the best; but, lest it should be found insuperably objectionable, he submits this second plan, which is that of "preventing the discharge of any sewer into the Thames above Millbank, or, perhaps, Neat House Gardens, and by keeping back the ascending tide at the same spot. The water above will then be the pure river water; and from this the metropolis may be supplied by engines in the usual way." The ascending tide he proposes to keep back by a strong dam or weir, which might be built of cast iron, in Decble's manner, across the river, and have, at each end of it, two locks for the passage of vessels. To prevent the foul tide water

from overflowing above the weir, the following ingenious contrivance, on the principle of the common ball-cock, and that of the self-acting sluice invented by the late Mr. Bramah, is suggested. "There must be contrived a strong leaf, suspended by proper hinges, and made buoyant, as soon as the water rises to it, by means of a copper tube, air and water tight, affixed to its lower edge. The tide, in ascending, will begin to raise this leaf as soon as it attains a higher level than that of the weir, and will thus be the means of barring itself out. The leaf, when raised quite up, will be supported against the weight of water by leaning against the pillars which rise from the weir and sustain the bridge above it, should such bridge be thought a desirable addition to the plan. As the tide ebbs, the leaf will, of course, fall gradually with it; and the waters which have been accumulated meantime above the weir will discharge themselves over the dam. By thus diverting the sewers from the river above Chelsea, and preventing the foul tide water from rising beyond that mark, the river, for miles up, might be considered as one grand reservoir of water, which, if not so pure as that of the Colne, would assuredly be far purer than any with which London is at present supplied."

Mr. Ainger's plan is as follows:—The drainage on each side of the river is to be received within "a wall extending along each shore, from about Vauxhall Bridge to the Tower, at a distance varying between 20 ft. and 200 ft. from the present wharfs or banks. The places so enclosed would constitute two main sewers, north and south; and they should be arched over at a height of from 3 ft. to 6 ft. above high-water mark, forming an extensive and very valuable quay or wharfage, wholly reclaimed from the useless, or worse than useless, part of the river; the usual width of which would, in fact, be increased by the deepening of the channel, which the contraction of the upper surface, and the consequent increased velocity of the current, would quickly occasion."

Of these two plans, Mr. Martin's would be much the easier to carry into practice; but Mr. Ainger's is certainly the more complete. We agree with the able editor of the *Mechanics' Magazine*, in thinking that "it must, sooner or latter, either in its present or in a modified shape, be adopted." Such works, including the sewers, and the supply of London with pure water, ought to be intrusted to a general commission, or undertaken by government. It is true, they might give rise to jobs, &c., in a corrupt government; but, when we make use of the word "government" without explanation, we are always to be understood as meaning self-government. Mr. Ainger, who is an architect, concludes the account of his plan with the following words:—"Plans of improvement, even the most reasonable and obvious, require to be made public many years before their advantages and difficulties are fully and generally appreciated. I submit this, therefore, in a somewhat immature condition, for the purpose of eliciting that discussion by which, if it be worth notice, its usefulness and practicability can alone be determined, and its ultimate success promoted."

A Plan for filtering the Water of the Thames, and supplying it to the metropolis and its suburbs, by L. W. Wright, Esq., engineer, has been communicated to the Royal Society, and is thus noticed in the *Philosophical Magazine* for May, 1831:—"The author, after giving extracts from the report of the commissioners appointed by his late Majesty to enquire into the supply of water to the metropolis, in support of the practicability of affording a supply of filtered water from the Thames, adequate to the demand, and within reasonable limits in point of expense, proposes his plan of forming a filter under the bed of the river for each company. He states that the deposit of mud on each side of the Thames does not reach below the low-water mark, and that the bed of the river throughout is

generally a clean and strong though porous gravel. The mud, therefore, will puddle in, and close the pores of the bed of gravel on which it lies above low-water mark, so that the filtration into the neighbouring wells, the waters of which are remarkably pure, must take place below low-water mark; and Mr. Wright proposes to construct a filtering chamber below the bed of the river; from which chamber a main pipe or tunnel must be made for conducting the filtered water into a well on the river side, whence it is to be drawn up by steam power, and distributed to the houses to be supplied, by the mains and branches at present existing. . . . The filtering chamber and apparatus are to be prepared by erecting a coffer-dam in the river, of sufficient size to enclose the whole of the area required for that purpose. This coffer-dam will require piles of 45 ft. in length. The bed of the river, thus laid dry, is to be dug out, and a bed of brickwork, set in cement, laid down: a floor must then be constructed in the form of an inverted segment of an arch. On the top of the walls of this floor plates are to be laid, and in the enclosed area, granite blocks placed; upon these, again, the girders are to be laid, and over these the joists, which are to support a first layer of large flints. Upon these, successive layers of smaller flints are to be arranged, decreasing in size as they approach the bed of the river. Upon the uppermost of these, a stratum of clean shingle is to be deposited, and then a bed of fine and very clean gravel; thereby forming a filtering bed of 8 ft. in depth, the top of which will still be 4 ft. below low-water mark. So that, allowing 7 ft. for the timbers and brickwork, and 18 ft. for the rise and fall of the tide, the total depth, at high water, will be 37 ft." We have no doubt of the practicability of this plan; though we do not believe it would free the water entirely from impurities, or remain many years in repair. To render the plan completely effective, it appears to us necessary to form a general sewer on each side of the Thames, and running parallel to it, for some miles above the river and for some miles below it, into which all the other sewers and drains of impure water might empty themselves. This would render Mr. Wright's plan complete. — *Cond.*

A Tub for measuring and weighing Corn. — I have lately invented a tub for measuring and weighing corn, which, I think, promises to be very useful. Corn of all kinds is here sold by the coomb, of four imperial bushels; but though nominally by measure, yet reference is always had to weight as well; and, accordingly, in buying grain, some idea is always formed, by the buyer, of its weight per coomb. If, on delivery, it falls short of this estimated weight, recourse is had to the bushel, to ascertain whether the quantity contracted for has been delivered. The measuring and weighing, being separate processes, take up a good deal of time; a vessel, therefore, by means of which the two operations might be combined in one, became a desideratum. The main difficulty consisted in the emptying after weighing, &c. To this end, a movable bottom appeared requisite; and, taking a hint from the water-balances in coal-pits, the valve *b*, in *fig. 78.*, was devised, as best adapted, by its conical form, to penetrate the body of the grain in the tub, and to allow of its free egress from the same when raised for that purpose. The next question was, as to the best mode of raising the valve. An ingenious mechanic of this place, of the name of Robinson, has effectually removed all my difficulties on this head, or, I should rather say, foot, by the application of the lever *d*, which is put in action by the pedal *c*, as shown by the dotted lines in *fig. 78.* When the foot is applied to this pedal, the valve is raised, as shown in the figure, and the corners of the tub being rounded (see the section, *fig. 78.*), the tub is emptied in quick time. Of course, the tub should be suspended high enough above the floor to allow the corn sufficient room to escape. To this end, a platform *f*, something like what is here called a horsing-block, is necessary. Up this platform the man bearing the sack of corn walks; and, the

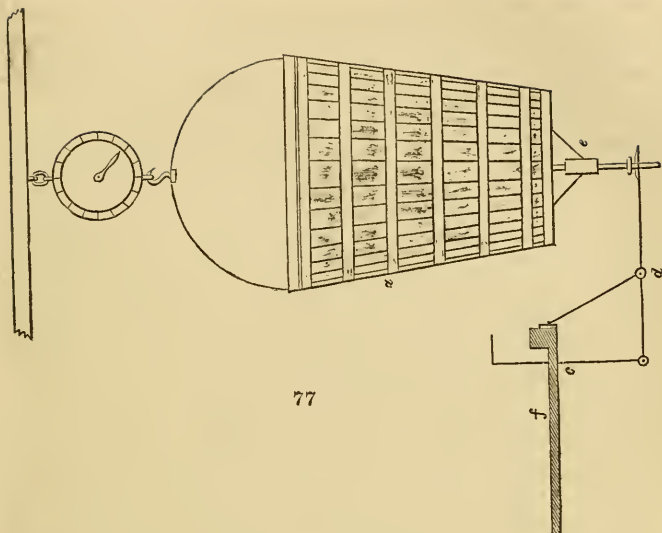

77

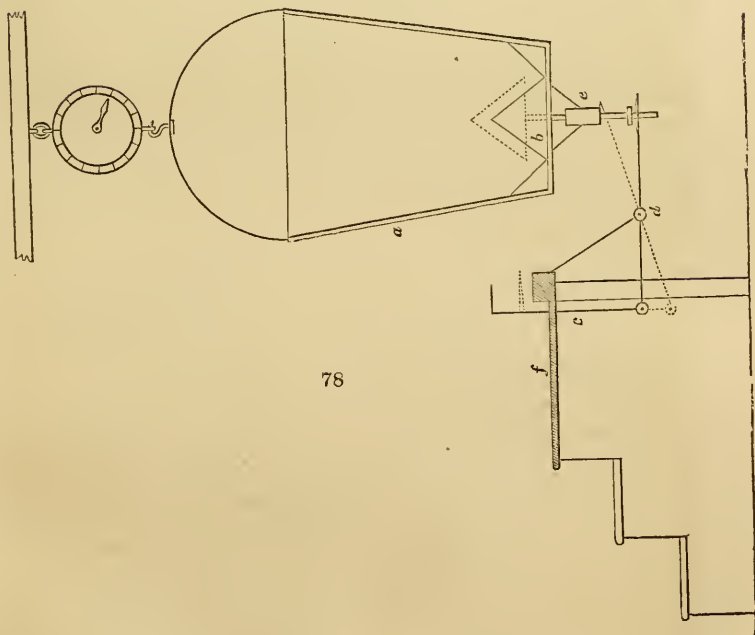

78

mouth of the sack being previously untied, shoots the contents, very gently and gradually, into the tub. I say gently and gradually, because, without this precaution, there will not appear to be full measure, although, properly delivered, there may be no actual deficiency. The mode of weighing may be either by Marriot's dial engine, or by a steelyard beam. The former is, perhaps, the most correct, certainly the most simple, and the most scientific; though three out of the four we have put up at the Whittington malt-houses, near this place, are on the latter plan. — *Samuel Taylor. Stoke Ferry, Norfolk, June, 1832.*

A Lapland Lock, which may be useful to Gardeners. — Sir, In looking over some papers the other day, I accidentally found a pen-sketch of a Lapland lock, made some years ago, whilst attending the lectures given by Professor Farish, on experimental philosophy, at Cambridge. The lock in question was presented to the professor by the late Dr. Clarke, upon his return from his travels in the north of Europe, and is now, I believe, annually exhibited at the lectures of the worthy professor, as an ingenious piece of mechanism made by the poor Laplander. The way in which the celebrated traveller became possessed of the said lock it may not be uninteresting to know; I therefore quote his own words: — “After leaving Kilpala, to avoid the passage of a cataract, we landed, and walked by the side of a river, until we came to a farm destitute of its inhabitants. Upon the door of their steam-bath we found a wooden lock, with a wooden key left in it; the whole being so singularly and ingeniously contrived, that we committed a theft for the benefit of the proprietors, and left a small sum of money, for the said lock and key, upon the house table.” (*Travels in Russia*, vol. v. p. 466. 4to edit.) Might not this lock be used for the doors of tool-houses, rustic summer-houses, &c., for the purpose of excluding outlandish folk, who commit thefts, but in a different manner to that of Dr. Clarke: and might not, also, the leisure hours of the gardener be agreeably employed, and his ingenuity exercised, in its construction? These being my objects, I venture to send it. The lock is made of oak, about 10 in. long, 6 in. broad, and 1½ in. deep: three loose pieces of wood (*fig. 81. o*) each 6 in. long, and three quarters of an inch square, with a notch 1½ in. wide, and half an inch deep (*fig. 79.*), are placed in the three grooves,

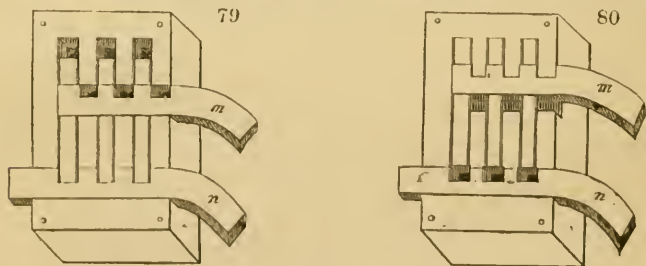

as may be seen in *fig. 79.* or *80.*



81

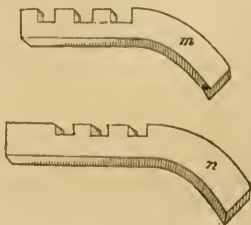

The key (*m*) 1½ in. wide, and half an inch deep, with corresponding teeth, about three quarters of an inch in depth, is to be placed across the notches, as in *fig. 79.*: When the key is slid upwards, the several loose pieces of wood are also raised at the same time: the bolt (*n*) is then set at liberty, as in *fig. 80.*, and may be drawn out, and thus the door unlocked. The bolt is about 1½ in. wide, and

three quarters of an inch deep, with teeth similar to those in the key. By observing the figures, the construction may perhaps be made out more easily than by any bungling description of mine. Yours, &c. — *E. W. jun.* Near Leeds, March 15. 1832.

The different Modes of heating Hot-houses, by hot water, steam, and common smoke flues, are frequently adverted to in your Magazine, and as often remind me of a steam apparatus for forcing, or rather for assisting the growth of peaches, which I had to attend to as far back as the year 1790-91. At that time there was "a rage" for steam-kitchens; and Mr. W. Slack, ironmonger, of Cheapside, was extensively employed in erecting them. Among others, he was employed by the late Gilbert Slater, Esq., of Low Layton, in Essex, a gentleman as remarkable for his hospitality as eminent for his love of every branch of gardening, who conceived the idea of having steam generated from pure water, instead of the then common mode of raising it from the flues of hot-houses. Mr. Slack was engaged to furnish the apparatus; which he executed, by placing a shallow cast-iron boiler over the common furnace of the peach-house, whence he led a main tin steam-pipe along behind the trellis at the bottom of the back wall. This main pipe had branch pipes of a smaller diameter, inserted at about 4 ft. distances along its whole length, which, by having additional and movable joints to fit on, brought the steam to any part of the middle of the house. By these means the trees could be copiously steamed at pleasure; and great vigour of growth, with perfect cleanness and freedom from insects, was the consequence, together with fine crops of fruit. I know not how long this apparatus was used, but probably not after the lamented death of the proprietor, about the beginning of 1794.

It will readily occur to your horticultural readers, that this contrivance could only be useful during the first three months of forcing; and, as the house was not entirely heated, but only moistened, by steam, it was, in fact, an unnecessary refinement of cultivation, which might have been dispensed with. This very attempt, however, may have led to the great improvements, since accomplished, in the management of steam for gardening purposes. — *Senex.*

In the *Gentleman's Magazine* for 1740 is a scheme, by Mr. Cook, for heating the whole of a house from top to bottom, by small steam-pipes from one boiler. The scheme must have been thought of some importance at the time, as it is illustrated by a woodcut. — *Cond.*

Charms of the Peacock Iris (*Iris pavonia* Lin.), *Vieussèuxia glaucòpis* of De Candolle). — Do tell all your flower-loving friends to lay out 1s. 6d. at Noble's shop, in Fleet-street, or elsewhere, in the purchase of a bulb of *Iris pavonia* L. (See Curtis's *Botanical Magazine*, vol. v. pl. 168.) I bought a bulb at the above shop, last autumn, and it is now in blossom, and the most lovely thing in the shape of a flower I almost ever saw. The three large petals are streaked with blue underneath, and above are pure white, with a most vivid eye-like spot at the base of each: one might almost fancy that Nature had at first intended to make the petals blue (as in so many others of the same tribe), but afterwards changed her plan, and reserved all the colouring matter to be concentrated, as it were, in one glowing spot of small dimensions, but intense brilliancy. — *W. T. Brec.* Allesley Rectory, June 6. 1832.

The Peach and Nectarine Trees distinguishable when in Blossom, by a Difference in their two Germens. — Sir, I have frequently found it useful to be able to distinguish peach and nectarine trees from each other, at an early stage of their growth, when both first produced their blossoms, before fruiting. To effect this, I dissect a few of the flowers of the trees about which I feel a doubt; and a tree which produces villose germens always proves a peach tree, and a tree producing germens smooth and shining

proves a nectarine tree. I am, Sir, yours, &c. — *John Mitchell, Gardener, Slapton, near Dartmouth, Devonshire, April 27. 1832.*

A newly invented "Cooking Alembic" has been sent us by Mr. Groom, of Bury St. Edmunds. The inventor originally intended it for cooking potatoes; but, after "repeated trials, he finds it may, with equal effect, be applied to every kind of vegetable." It differs from other potato steamers, in draining off the condensed steam without allowing it to return upon the potatoes, "so that no possible impurity can remain among them. When we have tried it a little longer, we shall probably give a figure and description of it, together with our opinion of its merits, which, we may observe in the mean time, is highly favourable. Those who understand how to boil potatoes in the manner directed by our correspondent A. W., Vol. VII. p. 369., need not, however, have recourse to any description of steamer for cooking them.

ART. II. *Domestic Notices.*

ENGLAND.

A *BOTANICAL and ornamental Garden* is proposed to be established in the neighbourhood of Regent's Park. A very interesting site is fixed on, including that well-known beautiful green knoll, Primrose Hill. The ground selected contains about 20 acres. It is proposed to lay this out so as at once to exhibit a highly ornamental pleasure garden, and a strictly scientific and systematically arranged botanic garden.

Green-houses, conservatories, and stoves will be erected; and to these it is intended to add a museum, a theatre for lectures, and a library to contain the principal works on botany, horticulture, and agriculture, both British and foreign. In the theatre, through the spring and summer months, occasional courses of lectures will be given on botany, vegetable physiology, and agriculture.

It is proposed that this undertaking should be carried into effect by a capital to be raised by such as are willing to become proprietors. The sum necessary for laying out and enclosing the ground, erecting the various public buildings, &c., has been estimated, in round numbers, at 30,000*l.* This it is intended to raise by 600 shares of 50*l.* each. The garden and stock to be vested in trustees for the proprietors, and the whole arrangement to be under the management of a committee, to be annually elected by the shareholders from amongst themselves, with every provision, &c., so as to give the proprietors that real and substantial control over the management and affairs of the society, which is so necessary to the scientific conduct of undertakings of this nature.

It is proposed that each shareholder, and (upon payment of one guinea annually) the wife of each shareholder, should have the perpetual right of access with their friends to the gardens, library, and lectures: that the owner of two shares (and in the same proportion for every additional share) should have the power of introducing four persons, and of giving two perpetual personal admissions to the gardens, &c.: that he should have the power of nominating friends to be annual subscribers to the gardens and lectures (this, it is considered, will be particularly desirable to families); and that the public be admitted on the same plan as the admission to the Zoological Gardens, and upon such terms, and under such restrictions, as the committee for the time being may direct. It is presumed that a revenue may be easily obtained from annual subscriptions, and from the public at large, sufficient, after payment of the rent, to answer the current expenses

of keeping up the gardens, &c. &c. Such surplus as may arise, after paying the expenses, will be paid to the shareholders, as interest on their capital, to the amount of 5 per cent; all beyond this sum to be sunk as a permanent fund for the future improvement and maintenance of the garden. It is proposed that the society should have a complete collection of plants, to be added to by exchanging with other societies, by purchase, and by one collector or more to be sent into foreign countries; and that surplus plants be distributed to the proprietors and donors, as the committee may direct.

A bird's-eye view of the garden, on the supposition that the hot-houses, &c., have been erected, is now exhibiting at Somerset House; and an engraving from it has been published by Priestley and Weale, the eminent architectural booksellers, in Holborn. This design, we understand, is by an ingenious young architect and beautiful draughtsman, Mr. W. B. Clarke, 9. Chapel Street, Bedford Row, who, the printed prospectus informs us, will give every information, by letter, to those who are desirous of becoming proprietors or subscribers.

We sincerely hope that this most laudable project will be realised, and we see no reason whatever to doubt that it will, and that it will pay the proprietors handsomely. Nay, we will go farther, and say that there is room, in the neighbourhood of such a metropolis as London, for half a dozen of such gardens, all of which would pay. The public taste only wants direction in this way. There is also a great want of good rural coffee-houses. Let any one who has spent any time at Berlin, Vienna, or indeed any large town on the Continent, reflect on the difference between them and London in this respect. Comparing the size and the population of London with those of any of the Continental towns, it will be found that in general we have not a tenth part of the rural coffee-houses or tea-gardens which they have. We know to a certainty that these gardens pay well; we have a scheme for one of a description altogether new in this country, but we have no leisure to attend to it. The essence of it consists in covering two or three acres with a glass roof, and laying out the interior as a tea-garden. We have a spot in view, and know a contractor who would put up the roof, and complete it, at 5*s.* per square foot.—*Cond.*

The Garden of the Horticultural Society is looking remarkably well; and, considering the small number of hands (compared with what there was seven years ago) allowed for keeping it up, it is in astonishingly good order. It is found that since visitors have been allowed to walk round the garden unattended, and the flowers and fruits as it were committed to their honour, as is done in all the gardens, public and private, in France and Germany, not an article has been touched. We are certain that the same result would take place in every case, even in that of what are commonly called the lowest rabble, were similar confidence manifested. The moment you place confidence in a man who has been hitherto treated as a machine, and guided by the principle of fear, you call into action a new principle, that of honour. The "rabble" would not show this all at once, because habits long persisted in cannot all at once be shaken off; but that they would do so, sooner or later, those who know human nature best will least doubt. To show a man that you have confidence in his integrity, is to call forth at once all that is good or noble in his nature; and to show him that you suspect him of evil, is to rouse all the worst passions in his breast. No man is either all goodness or all wickedness; and it depends almost entirely upon the treatment he receives, which principle shall predominate in his actions. Even in the most depraved characters there is generally some spark of goodness still remaining, which may be fanned into a flame by judicious management. Some years ago, one of the worst subjects of Van Diemen's Land, a runaway convict, who had taken up his abode in the bush, and afterwards committed about a dozen murders while

seizing and carrying off the cattle of the settlers, was at last caught, and among his papers was found a memorandum of flower-seeds which he wished to obtain for his garden. Had this man, before he left England, been in circumstances that had placed him above temptation, there can be no doubt but that he would have been a lover of horticulture, and a good man. And here, though it may be considered a deviation from the subject, we cannot help observing on the admirable fitness of the cooperative system, when mankind shall become in a meet state for adopting it, for destroying all temptation to crime, and calling forth only, or chiefly, the benevolent feelings of human nature. But we had almost forgotten our subject, and must return to the garden, for the sake of noticing that a great improvement has been made in it, by laying down the flower-garden with grass seeds for turf, and varying the surface by groups. This will diminish the labour of keeping, afford pleasanter walks, and be more agreeable to the eye. As to improving the garden in a scientific point of view, that is next to impossible; the whole, as we have often said, would need to be remodelled.

The "magnificent Triumphal Arch," erected at the west end of Piccadilly, and intended as a gateway to the palace gardens at Pimlico, has lately been made a public entrance to the carriage-road leading to St. James's Park and Whitehall, and the apartments intended for the keeper have been turned into a station-house for the police. "Sic transit gloria mundi!" The immense reservoir, which we have before (Vol. VII. p. 99.) spoken of, is planted out by large evergreens, and may now be reckoned not only useless in reality, but without even the appearance of either ornament or utility. Both the pond and the arch, with its gorgeous bronzed gates, we consider as monuments of the folly and extravagance of the government under which they were executed, and of the bad taste of the architects who designed them. The bronzed railing to the Duke of Wellington's house opposite, is another instance of extreme bad taste; as is also the marble triumphal arch in the front of Pimlico Palace. We shall show at once that we are correct in asserting this, by recurring to first principles, caring nothing for the authorities that may be found for placing similar arches and railings in similar situations. Every thing must be brought to the test of principle, otherwise there can be no solid foundation for right and wrong. Good taste is nothing more than sound sense applied to matters appertaining to ornament and luxury. One of the first principles of sound sense or good taste is order, or that disposition of things which, by their being seen one after another in succession, contributes to the grand end or purpose in view. Now, one of the first principles of order is to proceed in regular gradation from less to greater, or from greater to less. Without this, it is evident there can be no order; for, unless there be a reason for what was to go before, or come after, any particular point in the series, the result must necessarily be confusion. To apply the principle of gradation to the external and internal ornaments of a house, we should say that an ascending series is required from the ornaments on the exterior walls and fences to those on the furniture and finishing of the hall, staircase, and rooms within. Now, taking the highly enriched bronzed railing of the Duke of Wellington's boundary fence as the lowest point in the scale of ornament, the rails for his staircase ought to be of gold and filigree work; and for his grates, fenders, and fire-irons, no metal that we know of would be sufficiently precious. Apply the same reasoning to the marble triumphal arch at Pimlico, and what shall we find costly enough for the chimney-pieces of rooms of the palace to which it belongs? We say nothing of the unsuitableness of such materials, and such a style of ornament, to our climate, but have merely confined ourselves to the principle of order or gradation. The Duke of Wellington's gorgeous railing, and his meagre, clumsy, and paltry-looking outside Venetian blinds of unpainted

iron, show forcibly the want of the principle for which we have been contending. As to the palace at Pimlico, it is altogether beneath criticism, and may be considered as the last act of a reign of extravagance and folly scarcely to be paralleled in the annals of nations. Attempts are making to complete this palace as a royal residence, but it would show much better sense, in our opinion, to rase it to the ground, and throw the gardens open to the public.

Kensington Gardens are now undergoing a system of draining and ploughing up the grass land, to the great annoyance of the public, more especially as, along with these operations, about 120 cows and bulls have the run of the gardens. The ploughing and paving ought to have taken place early in spring, when it would have been done with much less labour, and much more effectually. It is worthy of remark, that these gardens have been drained by small brick arched drains, the bricks being set in mortar; and that, partly for this reason, and partly because the tops of the drains have been made rather too far below the surface, they do not seem to have answered the end proposed. Common rubble drains, brought to within 6 in. of the surface, would have been much more effective, and might have been formed with the screenings of the gravel, which might be dug from certain parts of these gardens. These extravagant and nearly useless brick drains must have been a capital job for the king's bricklayer at some former period.

The Pleasure-Ground at Kew has lately been enlarged, by an addition of several acres behind the palace. The surface is smoothed, and sown down with grass, and it is supposed that the arboretum will be extended in this direction. We were rather disappointed at seeing that a very bad mixture of grass seeds had been employed, which will of course retard the process by which that beautiful, deep green, smooth, velvet-like surface, almost peculiar to England, is at last acquired. In the stove of the botanic garden we observed a number of orchideous epiphytes bearing seeds, a thing hitherto scarcely known in this country. It is effected by the artificial removal of the anthers, and their being brought in contact with the stigma; a fact which will go far to destroy the doctrine of fecundation by internal absorption. The king is said to be attached to Kew, and to be desirous of improving both the botanic garden and the pleasure-ground; news which we are very glad to hear; for they have both suffered much during the last two reigns, from the want of that soul of all gardening, and, indeed, of every other kind of improvement, money.

Mr. Weltjie's Collection of Pelargoniums, near Hammersmith Bridge, was this season most superbly in bloom. We have never seen any thing like them for vigorous growth, and profusion of flowers. There are near a hundred sorts, the greater part of which were raised by Mr. Weltjie from seeds. The father of this gentlemen is well known to the floricultural world, by the very fine varieties of carnations and tulips which bear his name. — *Cond.*

Magnificent Pæony. — A *Pæonia Moultan*, now growing in the garden of Lady Stapleton, at Gray's Court, Henley on Thames, was turned out of a small pot in the open air, about fourteen years ago. In May, this year, it was measured, and found to be 5½ ft. high, 27 ft. in circumference, and bearing 230 flowers, each averaging 6 in. in diameter. Should you publish the above, I should be glad to know if there are any of a larger size in the country, and if so, where they are to be seen. — *Hugh Mulholland. Gray's Court, May 28. 1832.*

Calceolaria Atkinsiana, sent us by Mr. Atkins, the nurseryman, at Northampton, who raised it, is a beautiful hybrid, very much like *C. Youngii*. It is perfectly hardy, and has been in flower with us ever since we received it.

A Hybrid Laburnum, with purple, or rather lilac, Flowers, mentioned in a

former Number (Vol. VI. p. 335.), as having been brought to this country by M. Vallet of Rouen, flowered in our garden at Bayswater, this year, for the first time. As it is a vigorous-growing plant, it will be a great acquisition to the ornamental scenery of the country. —*Cond.*

SCOTLAND.

Your Article on Scotch Cottages will, I trust, not be lost on your countrymen here, as well as in Ayrshire. I know not that we are quite so bad as they are in that county, but we are bad enough, and worse than I can tell you. I wish you had said more about their gardens; for, though the professional gardeners of Scotland are the first in the world, the kail-yards of the peasantry are, I do believe, the worst-managed, and the most tasteless, in Europe. With the exception of a very few places, they grow nothing in them but greens (called open kail in some places) and potatoes. Look at the cottage gardens in most parts of England, how they are decorated with flowers, and enriched with shrubs. Even some of the vegetables cultivated are ornamental, such as the scarlet runner, and the vegetable marrow: but talk to a Scotchman about these plants, and he will tell you the first is a poison, and the second nothing but water. The Scotch are, no doubt, in many respects, a very superior people; but they are far, very far, behind the English in generosity of character generally, and in all matters of cleanliness and taste. Can you find me a parallel case in England of a wealthy proprietor, like the Duke of Buccleugh, suffering his farmers to erect whatever sort of cottages they choose for their labourers? The thing is monstrous. Look at the cottages on any of the great estates in England; the Duke of Northumberland's in the north, the Duke of Newcastle's farther up, and the Duke of Devonshire's in the south and west. I could write volumes on the difference between the two countries — but * * * * — *An Englishman. Edinburgh, May 28. 1832.*

A small Nursery, or rather Botanic Garden, for very rare plants, has been commenced by our esteemed correspondent, Mr. Goldie, at Wrightfield, near Ayr. We have seen a priced list of very rare and beautiful articles, entirely hardy, and chiefly herbaceous, cultivated by him; and, knowing Mr. Goldie to be remarkably correct in his botanical nomenclature, and worthy of the greatest confidence, both as a botanist and a man, we cannot but strongly recommend him to public patronage.

A Gardener distinguishing himself in any honourable way is always to us a source of satisfaction, and we have seldom been more gratified in this manner than by the perusal of a speech of Mr. Finlayson, gardener, at Haddington, as reported in the *Scotsman* of May 5. Mr. Finlayson spoke figuratively of plants and flowers, and applied his metaphors to the passing subject of the day (Reform), in a manner which did credit to his fancy, taste, and judgment. A man may be a very good gardener, without troubling himself with any thing else; but, if he knows nothing else, he may as well be a slave as free. —*Cond.*

IRELAND.

Gardening, notwithstanding our political commotions, and the dreadful state of uncertainty that this country will be in for some years to come, appears to be prospering. Seven years have elapsed since I saw the gardeners in the neighbourhood of Dublin, and I certainly know some difference in them. The exertions of Mr. Mackay, both in his own garden, and in promoting a taste for plants wherever he goes, have had no small influence in producing the present state of things; but by far the most scientific and enthusiastic young gardener in the neighbourhood of Dublin is your correspondent, Mr. Mallet, jun. If this young man were consulted by the Dublin architects, he would teach them what they know very little of at present, how to apply the modern improvements in heating and ven-

tilating both to private and public buildings. I have seen the first part of your *Cottage Architecture* here on one or two tables. Were this country in a state for building cottages, I am persuaded it would do much good, by teaching the masons and carpenters this part of their business; for, as to architects, no Irish gentleman would ever think of employing one, unless he were going to build a mansion, and then he is sure to send for an Englishman. You shall hear from me again from Belfast. In the mean time, I am, &c. &c. — *R. S. Dublin, June 1. 1832.*

The Garden of the Bishop of Cloyne. — “You ask me to explain, at length, the particulars of my situation at Cloyne. This place, which is a dirty Irish village, lies in a valley that seems evidently to have been formed, in some distant age, by the waters of Cork harbour in their way to the sea; a branch of that harbour still reaching a considerable way up the S. W. part of it, and the Bay of Ballicotton encroaching on it towards the N. E. On every other part extends a chain of hills well cultivated, but without trees. In the middle of the valley, about three miles from the harbour, and as much from the sea, rises a small insulated hill, or rather hillock, on which lie the village, church, and house; and as this spot has a few tolerable trees about it, and is ornamented by a fine round tower, I do not wonder that an Irishman coming from Dublin through a naked country, for a hundred and fifty miles, should think it a beautiful spot; or that an Englishman landing in Cork harbour, and comparing it with his own rich and well-cultivated valleys, should wonder at Berkeley's liking it. The church is large, but not handsome, with one bell only, a very good organ, and its proper appurtenances of vicars choral and singing boys. The episcopal house is at the east end of the village, a large irregular building, having been altered and improved by different bishops, but altogether a comfortable and handsome residence: the side next the village has a very close screen of shrubs and trees, and the three other sides look to a large garden, and a farm of four hundred acres. This farm constitutes what is called the glebe lands, is generally close to the palace, and was intended for the corn and cattle consumed at the bishop's table. The bishop is therefore not allowed, by act of parliament, to lease it out, but may let any part of it from year to year. I keep about fifty acres, enough to supply my stable with hay, and my dairy with milk, in my own hands; and these fifty acres compose three fields immediately contiguous to the house. The garden is large, four acres, consisting of four quarters, full of fruits, particularly strawberries and raspberries (which it was soon found his lordship had a predilection for), and is separated, as well as surrounded, by shrubberies, which contain some pretty winding walks, and one large one of nearly a quarter of a mile long, adorned for great part of its length, by a *hedge of myrtles 6 ft. high, planted by Berkeley's own hand, and which had each of them a large ball of tar put to their roots: the evidence of this fact is beyond contradiction.* At the end of the garden is what we call the Rock Shrubbery, a walk leading under young trees, among sequestered crags of limestone, which hang many feet above our heads, and ending at the mouth of a cave of unknown length and depth, branching to a great distance under the earth, sanctified by a thousand wild traditions, and which, I have no doubt, sheltered the first wild inhabitants of the town in its gloomy windings; and gave rise at last to the town itself, *cluain* being the Irish name for a cave or place of retirement. Caves were, you know, till lately, places of retreat in the Scotch Islands, to which the natives fled in the time of invasion; they were the fortresses of the first savages, and gave birth naturally to towns in their neighbourhoods, as the Roman camps and Saxon castles did in England at a later period. I have enclosed this place, which is a favourite spot of mine, with a low wall, enlarged its limits, and planted it with shrubs which grow in this southern part of Ireland (where frost is unknown) to a luxuriance of which the tall myrtles I have mentioned may

give you some idea. Here I always spend some part of every day; sometimes with the mistress of my affections, with her arm in mine, I plan little schemes of future amusement; and, at other less playful hours,

‘ Walk thoughtful on the quiet solemn shore
Of that vast ocean I must sail so soon;
. and wait the wind
That silent wafts me to the world unknown.’

On a Sunday, too, the gates are always thrown open, that my Catholic neighbours may indulge themselves with a walk to the cave. A saint, I forget whether male or female, presides over its recesses:—

‘ Nemus, et nigra formidine collem,
Quis Deus incertum est, habitat Deus, Arcades ipsum
Credunt se vidisse.’

On all other days of the week, no one ventures to intrude upon my retirement, not even the prebendary in residence:—

———— ‘ Pavet ipse sacerdos
Accessum, Dominumque timet deprendere loci.’

At least so I found the rule established; but, as I hate the insolence of wealth, I have been employing the carpenters some time past in making that sort of gate which cannot be left open for cattle, or shut against man.

“Of Berkeley little is remembered, though his benevolence, I have no doubt, was very widely diffused. He made no improvement to the house; yet the part of it he inhabited wanted it much, for it is now thought only good enough for the upper servants. My study is the room where he kept his apparatus for tar water. I wish he had planted, instead of building; if, indeed, he built any thing, for I cannot find any tradition of it. Crowe, one of his predecessors, and Johnson, one of his successors, appear to have contributed most to the comfort of the place; but had there been a venerable oak or two nursed by the care of this excellent man, with how much respect should I have rested under its branches! and in no spot of earth do trees grow with more vigour. There is no chapel in the house; but a private door from the garden leads to the cathedral. The bell is in the round tower, the gift of Davies, dean of Ross.

“I have thus, I think, run through every thing relative to the situation of Cloyne. The neighbourhood is good; the barony of Imokilly, which surrounds it, particularly fertile. Two lords are near me, Shannon and Longueville, hostile to each other, but vying in civility to me. The common people getting rich, from the money spent by the large detachments of the army and navy occasionally detained in Cork harbour; and giving any price for fresh provisions. Protestants, comparatively, none. We are twenty English miles from Cork, which lies much farther from its own harbour than we do. On the whole, if you survey this place with an English eye, you would find little to recommend; but with an Irish one, nothing to blame.” (*Bennett, Bishop of Cloyne, to Dr. Parr, in July 16. 1796; Works of Dr. Parr, by Johnstouc.*)—*G. M. Lynn, Dec. 1828.*

ART. III. *A Walk, on the 30th of June, round the Garden of the late Comtesse de Vandes. By J. D.*

THIS garden delights and surprises one the more from the situation in which it is found. The approach to it is through Lavender Mews, which, though far from scentless, effuse nought of lavender odour. On opening the closely boarded gate of the garden, fixed in the boundary wall which

encloses the garden from the disagreeable mews, a prepossessing display of floral splendour instantly bursts on the eye. A broad, straight, longish, gravelled, well kept, box-edged walk, conducts you from the entrance-gate up to the stove, one end of which just juts into view at the end of the walk, and to the gardener's residence behind it. This fine walk is supported all the way, on the right hand and left, by a broadish border, richly stocked with the more showy and comparatively choice herbaceous plants, all receding, in the order of heads at a theatre, from the walk, according to their relative heights, and supported in the rear by a liberal supply of well-established, large-headed, tallish-stemmed, standard rose trees. Two banks of flowers are thus formed, which slope to the walk; and the numerous plants now blooming, with their flowers in form and hue almost as various as the species which produce them, constitute a richly variegated scene, which cannot be viewed in any part of this walk, and from either end especially, without the spectator's being enlivened, refreshed, and gratified. The rose trees, although abounding in buds, had, as yet, scarcely expanded any of their blossoms, except the Boursault's and the crimson Chinese: Boursault's seems to branch too diffusively and droopingly to become an elegant standard rose tree. When the end of this walk and the corner of the stove are reached, you perceive that the stove forms but part of a range of houses which traverses the garden directly across its centre, and that the first-named walk divides itself, at the stove's end, into a walk in front and a walk behind this range. Walking along in front of the range, you have dwarf pits covered by lift-up lights hinged into the front wall of the houses on your left hand, and a lawn on your right. The lawn is the length of this range, is in figure the segment of a circle, and without great depth, but is occupied by the choicer herbaceous plants, and some shrubs, grouped in beds, and by various ornamental shrubs placed singly. Among the latter is a fine *Ribes sanguineum*, bearing numerous oblong berries, which, in their present green state, are even more astringent than are the black and ripened berries of the fragrant-flowered *Ribes aureum*. A *Chionanthus virginica*, a bushy broad-leaved shrub 6 ft. in height, is now abounding in panicles of blossoms, which are cut into linear segments, and so may justify the appellation of fringe tree, as their snowy whiteness does that of *Chionanthus*. A very fine *Althæa frutex*, whose multitudinous buds are just now perceptible, and promise how superbly showy it will be some weeks hence, is another of the single shrubs. A cincture of flowering plants and shrubs encircles the back or bottom of the lawn, and separates it from the horticultural quarters situate beyond, which, by these shrubs and flowers, are partly concealed from view. Leaving the lawn, you have reached the other end of the range of houses, and there behold the exact counterpart of the opposite side of the garden, that up which you passed on entering, namely, a similar broad walk, skirted on its two sides by two borders of the same capacity as those beside the first-named walk, and, like them, beautified with the lovely furniture of blooming herbaceous plants, and standard rose trees, for the most part yet in bud but very partially in blossom. Between the back of the outermost of the flower-borders, on both sides of the garden, and the boundary wall or fence, a short space intervenes as a border for the fruit trees, with which the boundary walls are fruitfully occupied. The inner two of the above-named four flower-borders, and the cincture encircling the back or bottom of the lawn, enclose three sides of the central part of the garden, which is in figure a rectangular oblong, and appropriated to the growth of vegetables and fruits; but even here the love for decoration manifests itself in some standard rose trees and other objects of ornament planted beside the cross walks. It should have been remarked, that the two outer of the four flower-borders mentioned are led round, past the end, and one of them to the back, of the range of houses, where they terminate. The

wall of the gardener's cottage is ornamented with shrubs trained over it; a healthy Boursault's rose, being one of them, is now finely in flower: a very narrow border at the wall's foot is occupied by a few species of plants which have been found adaptable to that situation. Sheds wing the gardener's house to the right and left, and, with a room for the accommodation of the men (see Vol. VII. p. 617.), make up the whole back of the range. This being a northern aspect, here, during summer, is kept a limited but select collection of potted alpine plants, among which that tiny exquisite, *Linària alpina*, was about to bloom profusely, and *Lithospèrnum marítimum* (*Pulmonària marítima* that used to be) was displaying its strikingly glaucous foliage, and *Mitèlla diphýlla* was exhibiting its glistening jet black seeds in its opening capsules, shaped precisely like diminutive mitres, whence the generic name. In this collection stands a plant, not now blooming, but well deserving mention here, *Ranúculus bulbòsus* var. *ochroleùcus*; it was picked up in some neighbouring meadow, by that observant and original botanist, Mr. David Bishop, curator of the Botanic Garden at Belfast, and has, for three seasons in succession, produced its blossoms of the palest yellow: it is a very cognisable and a permanent variety, and, as such, is inserted in the just published *Additional Supplement to Loudon's Hortus Britannicus*. It was remarked that the range traverses the garden across its centre, but the half behind the range is much the smaller, and wholly occupied by vegetables and the forcing-frames and conveniences, except a sunk pit, with a walk along its back, inside, for the culture of the more showy tender *Orchídeæ* and *Amaryllidææ*.

To have done with the borders, I will name some half a dozen individuals, which, on this occasion, happened most particularly to arrest my attention:—A species of *Yúcca gloriòsa* was densely in bloom, too densely to make the most of itself; *Gèum coecíneum* and *Quèllyou*; *Pæònia edùlis* *Whitlèyi*, *edùlis fràgrans*, and *edùlis Hùmei*; *Campánula macràntha*, very fine; *Arum Dracúnculus*, especially so, one clump of it had not fewer than five extremely large spathes expanded together, and more yet to be expanded; *Anchùsa itálica*, *Centaurea macrocéphala*, *I'ris ochroleuca*, the French white double rocket, and numerous others, which I must omit to mention. This French white double rocket thrives far better about London than the old kind, has a longer and laxer raceme, the flowers, individually, being farther apart, and, I think, larger, and quite as fragrant in the evening as those of the old kind. Of a gigantic variety of the Norman candytuft (*Ibèris umbellàta*) numerous plants, placed singly, at intervals, along the border, were in blossom. This is a valuable ornament; it attains the height of 2 ft., and sometimes beyond this; and the usual colour of the species is, in many of the plants, much increased in intensity: the effect of the large corymb of umbels, which each plant forms, is a mass of colour of the greatest value to the purposes of the decorative gardener. Among curious plants was an admirable clump of the *Allium nigrum*, displaying not fewer than six or eight fine umbels of flowers; *Phlòmis tuberòsa*; *Spiræa Filipéndula*, double-flowered, which is common about Bayswater; *Asphòdelus créticus*, which seems as if a more elegant edition of the prevalent *A. luteus*; and two fine plants, copiously in blossom, of that hybrid *Digitális* obtained from seeds of *D. ambigua*, which had been artificially impregnated with the pollen of *Gloxínia speciosa*, as already noticed in this Magazine (Vol. VII. p. 582., in the note). The flowers of the hybrid differ from those of *D. ambigua* in being slightly larger, more fleshy in texture, and in having the yellow ground almost obliterated, or coloured over with a reddish one, the colour being now, perhaps, a buff red one; the leaves are those of *D. ambigua*, much increased in size, and, I think, in pubescence and perhaps in succulency. *Láthyrus latifólius* var. *albiflorus*, which flowered so finely in this garden last autumn, is now rising strongly,

with numerous stems, to do the same this autumn, or, perhaps, rather, end of summer. The mandrake is abounding in green, almost globular, berries, the size of half-grown oranges, and which they will, when ripe, further resemble in their colour, and in their pulp being fragrant, although the odours of the two kinds of pulp are different enough.

The range of houses consists of a stove of twelve lights, a tea-room, and two green-houses of six lights each; so that the tea-room occupies the centre of the range. On passing through the stove, which is richly stocked with a choice collection of species, the following objects most obtained attention:—*Combrètum comosum* had been blooming profusely and vigorously, and a few last lingering blossoms yet remained; *Combrètum purpureum* was also now in blossom, but past its best: these two species are now referred to the genus *Poivreæ*. *Erythrina Crista galli* was superbly splendid, in a vigorous raceme of its well known glorious blossoms; *Erythrina carnea*, almost without foliage, was about to flower; and *Erythrina cæffra* promised to succeed it. *Brássia maculàta* was adorned with a raceme of six flowers, the three exterior divisions of each of which are linear lanceolate, of a very pale yellow spotted with purple, and $2\frac{1}{2}$ in. long, so as to render the extreme expansion of each flower equal to 5 in.: the flowers are fragrant, and supported on an erect axillary peduncle, which reached to just above the leaves. *Cereus grandiflorus*, the night-blooming cereus, was about to flower profusely. On the night of June 25. three flowers had opened; as many as ten flowers, now, June 30., appeared, of equal age and forwardness, and as if they would all expand on the 2d or 3d of July, [of the ten mentioned, 9 flowered on the evening of the 2d, and one on the evening of the 3d.] and there were, besides, two buds so backward, that a week or two more must elapse previously to their opening. Of the genus *Xylophýlla*, very remarkable for bearing its flowers on the edges of its leaves, two species, *latifolia* and *longifolia*, were in blossom; and the flowers of *X. latifolia* are fragrant: those of *X. longifolia*, the plant not being conveniently accessible, I did not smell to. Two plants of *Cérbera Mánghas* were displaying numerous flower-heads, but would not flower for two or more weeks to come. *Líppia dúlcis* was now abounding in its very sweet liquorice-flavoured leaves, which remind one of those of another stove plant, the wild liquorice (*Abrus precatorius*), as well as those of the almost hardy *Verbena pulchélla*; but they far exceed in sweetness those of the last. A second plant of the most interesting *Billbérgia zebrina* (*zebrina*, in expression of the transverse bands of white formed at intervals across the back of its dull green leaves) was indicating the rising of a scape of flowers. A plant of this species, which bloomed about three weeks previous, here, was a gratifying object. The scape reached the height of 2 ft. from the top of the pot, and bore thirteen bracteas, from 4 in. to 5 in. long, and of the exquisite colour of the innermost segments of the blossoms of *Cereus speciosissimus*, which contrasted most strikingly with the dull green leaves and yellow green flowers. The flowers were forty in number, and, from their base to the tip of their long projecting stamens, 2 in. long. The sepals, of a yellow-green colour, at first cover these stamens; but when once they separate at the tip of the flower, where they had met, they roll themselves back into a scroll, and lie snugly beside the tip of the germen, like an unexpanded curl.

On quitting the stove, you pass through glass doors into the tea-room; and, on the opposite side of this tea-room see corresponding glass doors, which admit you to the green-house; and also enable the inspector in the tea-room, whether sitting or standing, to see therefrom part of the contents of the stove on one side, and of those of the green-house on the other. This room is a rectangular oblong with its corners cut off, making in effect an octagon with three unequal kinds of sides, the longest of which are formed by the stove and green-house ends; of the remaining sides, three

are at the back, and three project in front some feet beyond the line of the range of glass houses. In the central or larger of the three sides in front, a glass door with folding halves is placed; and, in the lateral sides, windows of the like construction, all opening to the ground, and enabling egress to be made at once upon the gravel-walk which traverses along the front, and from thence to the lawn, all the beauties of which are seen through the glass door and side windows, or to any part of the garden. This room is spacious; and from having no glass in its roof, and from its ceiling being lofty, is a luxurious place of retreat from the heat of summer. In it, on stands, a few select potted plants in flower are successively displayed, but not so numerous as to encumber. A fine healthy plant of the fan aloe (*Aloë plicatilis*) is now blooming there, and the plant is thought to be from twenty to thirty years old: it is possibly not more, as it seems by its wood never to have been checked in its growth; but, for its age, this is a very fine specimen. I have only seen one finer specimen, which is in the conservatory of the Cambridge Botanic Garden, and is very much older. In this tea-room, during winter, is kept one of the finest plants of *Acacia armata* I have ever seen. Its stem, at the surface of the soil, is 5 in. in diameter; its topmost boughs are at least 7 ft. from the surface of the tub, which is of itself 3 ft. or 4 ft. deep, being a cube of about this gauge. The branches of the plant are mostly on one side, and project 5 ft. or 6 ft. from the centre of the tub; and, in early spring, are headed abundantly with balls of golden blossoms, which, besides rendering the plant a glorious object to that floodgate of our delights, the human eye, effuse an agreeable odour very obviously perceptible on entering the apartment.

Leaving the tea-room for the green-house, you enter its end through the glass doors mentioned; and find it (the first one) occupied by a judicious selection of the more beautifully blossomed plants, which, though quite gay two months or more ago, are not now numerous in flower. The body or back part of the second green-house is occupied by a choice collection of the superior varieties of *Camellia*, admirably grown; and among their gorgeous display of blossoms which, each spring, they make, few excel in splendour the *C. japonica Vandèsii* and *Vandèsii superba*, two varieties obtained from seeds in this truly delightful garden. The pits in front of the green-houses are occupied by plants in pots of the frame-plant class. *Dianella cærulea* and *Arthropodium cirratum* are now blooming finely here; as is the beautiful *Dietes bicolor*, recently published in the *Botanical Register*, t. 1404., as *Iris bicolor*.

It should have been remarked, that, in front of the tea-room, this range of pits is interrupted; and as it was remarked that the tea-room's front projects some feet, it will be perceived that a recess is formed, which receives this range of pits, without rendering them objects too conspicuous. The pits in front of the stove are now occupied by blooming pelargoniums, which have passed the heyday of their this year's beauty; and by numerous seedling plants raised from seeds purchased of Mr. Hugh Cumming, a recent importer of a copious supply of the natural products of Chile into England. From the seeds purchased, and which must have been judiciously selected by the purchaser, many matters of promise have been raised. Of these, I collected notices of the following:—

Calecolarias, five shrubby kinds, all with foliage differing from those in common cultivation; one of these shows yellow blossoms. Of herbaceous species, one has purple flowers, and its lower lip, or slipper-front, is laid in plaits: this is a beautiful kind, and clearly distinct from *C. purpurea*; it has lanceolate toothed leaves, suffused with a very slight degree of whiteness. Another herbaceous species has leaves somewhat plantain-like, stems nearly 2 ft. high, branched in the upper part, and bearing numerous-flowered corymbs of blossoms of a rich full yellow colour. A third herbaceous kind has stems about 1 ft. high, bearing corymbs of blossoms

which are all of a red-brown colour on the exterior upper portion of the corolla; in the lower part, yellow. A fourth herbaceous kind has its younger leaves quite shaggy, the flower-scape about 6 in. high, the flowers largish, deep yellow, and the slipper internally striped with orange. In Leguminosæ, two plants of the *Loudônia*, noticed in Vol. VII. p. 690., are up, and 5 in. or 6 in. high; the leaflets of the pinnated leaves, and the leaves themselves, draw together on the approach of night, and evince what is termed "the sleep of plants" as sensitively as many plants of this order. Of Adésmia, two or three kinds are up; one of them bears branched thorns. In Compósitæ, there is a *Mutisia*, probably *ilicifolia*, with a deeply-winged stem, and oval, toothed, undivided leaves, each terminated by a long tendril; a plant with opposite, stalked, hastate, toothed, smooth leaves, and at present with but one, three or four flowered, corymb of white rayless heads of flowers, resembling, as seen glancingly, those of a *Eupatòrium*. Of Triptílion, there are two kinds. One with prickly foliage, and with branches tipped with numerous minute heads of whitish flowers; this is about 6 in. high, and will probably be but annual; the same kind has been raised in the Chelsea Botanic Garden. The second species has not flowered; but, from Mr. Cuming's specimens, bears blue blossoms. There are two species of *Chætanthèra* with yellowish blossoms. Besides these, there are several species of Compósitæ, some in bloom, of which I have no names to call them by. Of *Schizánthus*, three kinds have been raised. One is thought to be but a variety of *S. pinnatus*, as it differs chiefly in having two conspicuous spots on the upper part of the flower. A second kind has a compact form, stiff straightish branches, and very neatly pinnated leaves; in its flower, the whole upper part is of a very faint blush colour, the lower part of a kind of an intense red lilac, and in the centre of the flower is a yellow spot, itself spotted with minute spots of this lilac colour, which some would call a purple. The third kind is very pubescent, with gland-tipped clammy hairs. Of *Stáchys grandidentata*, there were five or six plants in bloom, their flower-stems near a yard high; among these plants were two or three strongly marked varieties. An herbaceous species of *Linum*, with small leaves, has borne a large yellow flower, the remains of which I saw: the plant seems perennial. Of *Verbèna*, there is a species with creeping stems, which emit roots from their joints, as the glorious *V. chamædrifolia* does; but this has faintly blush blossoms, not showy, and borne in axillary-stalked heads. There is a *Campanula* with numerous branched stems, about 1 ft. in their greatest height, and bearing linear leaves and numerous small white blossoms. Of *Lobèlia*, three kinds are up; one of these seems an ally of *L. Tupa*. Of *Escallònia*, there are two or three kinds; of *Ribes*, one kind; of *Francòca*, one kind, which is expected to prove the white-flowered species, *F. ramosa*; three species of *Salpiglòsis*, one of which is very beautiful, and considerably resembles *S. picta*; another will, I suspect, prove near akin to the *S. integrifolia*, lately figured in the *Botanical Magazine*, t. 3113.; and the third is considered to be *S. straminea*. A species of *Schinus*; a species of *Solanum*, the leaves of which call to mind those of *S. Pseudo-capsicum*, although they are more glaucous and succulent; a *Málva* with trailing stems, lobed toothed leaves, and axillary, red brick-coloured, peduncled blossoms; *Tropæolum tricolorum*, that one of the most elegant of green-house climbers. *Calámpelis*; perhaps distinct from *scabra*, perhaps not. A plant under the name of *E'phedra*, which is possibly *Retanilla E'phedra*, since figured in Loddiges's *Botanical Cabinet*, t. 1830.; a *Collètia*, which is possibly but *scratifolia*, previously in our collections; *Acæ'na*, two or three species; one species of *Umbelliferae*; *Aldèa circinata*; two species of *Alstræmèria*; two species of *Macræ'a*; and one little thyme-like plant, whose leaves, on contact, effuse the pleasant odour of pennyroyal. — *J. D.*

ART. IV. *Retrospective Criticism.*

THE Gardens of Frederick Bourne, Esq., and those of Counsellor West (p. 83. 371.).— Sir, From some observations which occur in your last Number, upon certain "corrections" which I lately sent you for the *Encyclopædia of Gardening*, I feel it necessary to recur to them, and will feel much obliged by your publishing the following, of which I doubt not you will perceive the propriety:—The writer of these observations, who is wholly unknown to me, says I have instituted an invidious comparison between the gardens of Frederick Bourne, Esq., and those of Counsellor West. I proposed no comparison of any kind: what I have said may be erroneous; but I deny that it is invidious. I am sorry to say, Mr. Conductor, that you are, I think, to blame in this matter. I sent you corrections for a new edition of the *Encyclopædia of Gardening* in a letter, part of which was not intended for publication any where, and the rest certainly not in the Gardener's Magazine, but in the work which it proposed to correct; and there, altered, divided, and properly allocated, by you. What I said of Mr. Bourne's gardens was intended to remove the impression which its standing noticed in nearly "solitary grandeur" was calculated to produce, and not with any view of decrying its intrinsic merits, which are many. The communication was confidential, and I must say you ought not to have crudely published it. I feel deeply concerned that it has ever met the public eye; the more especially, as I am honoured with Mr. Bourne's acquaintance; from whose memory, I have no doubt, should this "*amende*" meet his eye, the observations alluded to will be wholly effaced; and as you, Mr. Conductor, are not guiltless in the transaction, you cannot better show your contrition, than by giving with your usual candour the earliest possible insertion to this. I am, Sir, yours, &c.—*Robert Mallet. 94. Capel Street, Dublin, June 13. 1832.*

We hold ourselves perfectly guiltless. The communication (p. 83.) was evidently intended for being made public, as any one may perceive by turning to it. If it were not, why was it sent without being marked "private," like a postscript, for example, in the letter now sent, which, of course, we do not print? We consider it our duty to the purchasers of the next edition of our *Encyclopædia of Gardening*, to publish the corrections sent us for it first in the Gardener's Magazine, in order that their accuracy may be tested, and the necessity of this precaution is proved by our correspondent's letter.—We have received (this July 6th) certain iron flower-stakes invented by Mr. Mallet, which we shall be happy to figure in an early Number.—*Cond.*

The Circulation of the Sap in Chàra, discovered by Mr. Varley, not by Mr. Burnett. (p. 142.)— Sir, in the Gardener's Magazine, in the article "*On the Circulating System of Plants*," p. 142—147., my name is mentioned so as to leave an inference that I was in no way connected with the subject there treated of. I will therefore restate it, with such addition of my name, as those persons who know the facts have reason to expect. "On the 17th of January last, he (Mr. Burnett) exhibited with a good microscope, in which too great a glare of (it should have been, *all lateral*) light was avoided, by interposing Varley's dark chamber, several specimens of Chàra previously dissected (by Mr. Varley, that gentleman having succeeded in preserving the plant, and numerous young seedlings, in a thriving state all through the winter, and having obliged those who applied to him, with samples prepared and put up ready for microscopic exhibition); when the motion of the sap was demonstrated to the satisfaction of the then chairman, Sir J. McGregor, and was seen by almost every one present. . . . The course of the sap in Chàra is so far ascertained, that Mr. Burnett thinks himself justified in declaring (in the words of Mr. Varley) that

each joint or limb has an individual circulation; and although it may have a communication with other joints, yet that its motion is complete in itself. The section of a rootlet, or of a joint, shows it to consist of (the plant consists chiefly of tubes, which are somewhat tough and flexible: when any of these are cut, that length is killed, and nearly all the contents run out, therefore its true section cannot be seen; but, from careful and repeated examinations, Mr. Varley has ascertained that, supposing the section could be obtained, it would consist of) two lateral simple semilunar ducts (*fig. 82.*: this fact Mr. Varley discovered, and told to Mr. Burnett, who ought not to have used it without acknowledging whence it came), each being the channel of a current that traverses the joint in an opposite direction to the other; the course of the one being up, the other down." And from the great similarity exhibited by all parts of the *Chàra*, we may safely infer that such a section will serve for each portion even of the root; for although they are no thicker than the finest cobweb, yet, when highly magnified, they exhibit the same

82



83

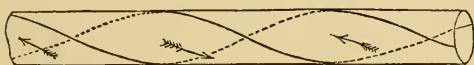

kind of circulation. The extremely thin inner cellular membrane which divides the sap from the central fluid, is attached to the tubes their whole length at two opposite sides, which lines of attachment take a spiral course around the tubes. (*fig. 83.*)

Now, Sir, I send the following statement, that you may know the facts. Because Mr. Burnett found it difficult to manage the *Chàra*, he requested me to favour him by exhibiting it for him, at his opening lecture at the King's College, and I have since supplied him with an apparatus of my contrivance, by which it may be kept growing, and ready for instant inspection during many weeks (which machine he has never recharged with *Chàra* himself, but always sent to me to be replenished); and it has so happened, that nearly all the *Chàra* that has been publicly exhibited during the winter, was of my providing and fitting for microscopic use. I have repeatedly exhibited it at the Royal Institution at their Friday evening meetings; and at the Tuesday evening meetings of the Society of Arts, &c.; and have in the 48th vol. of the *Transactions* of the last-mentioned Society, given a tolerably full description, accompanied by engravings, of the plant. I believe, if Mr. Burnett had attempted to dissect the *Chàra*, he would never have said that "a section of a rootlet, or of a joint (see p. 143.) shows it to consist of lateral ducts," &c.; for it shows no such thing: nothing is seen but a tube, somewhat like a quill, dirtied by some of the broken up membrane that had been on it. I have washed short lengths of this membrane out in two ribands, and also as a whole tube. It consists of minute cells united by a membrane so extremely thin as not to be touched without damage. Leaving these facts entirely at your disposal, I have only to add that I shall be happy to show you my contrivance for preserving such objects alive, and quite ready for placing under the highest power of a microscope. I remain, Sir, yours, &c. — *Cornelius Varley. Charles Street, Clarendon Square, Somers Town, June, 1832.*

Corrections for this Magazine, and for the Encyclopædia of Gardening.—

Sir, As you appeared to consider my contributions to your Magazine to be of little importance, and to treat me with indifference, I withdrew my attention from it altogether from June, 1830, and should not have troubled myself further about it, had not a young nurseryman, on inspecting my trees, observed that he had seen my method of training my reversed dwarfs, published in your Magazine, Vol. VIII. p. 437., which he took in. I borrowed it of him, and also your *Encyclopædia of Gardening*, which I had not before seen; and, notwithstanding you published my paper of

February, 1830, in your Number for August, 1831, I perhaps should not have again obtruded upon you, if I had not considered myself as publicly treated with great illiberality and injustice, in both your Magazine and *Encyclopædia*; but, as this is the case, I trust you will consider me entitled to a public explanation, and afford me an opportunity to defend myself, by giving this address an early insertion in your Magazine.

On examining the index of your *Encyclopædia*, I could not find my name; but observing that of "Heywood," I referred to the page directed, and there I found that you had given my name correctly, but described me as having been a Yorkshire clothier; whereas I never was a Yorkshire, but was a Wiltshire, clothier.

In your description of the practice of gardening, under the head *Peach*, you say (§ 4503.), "Hayward suggests the *wary-fan* manner, as likely to answer better than the common mode of fan-training;" thus treating it as a mere theory; but if you quote my book (*Science of Horticulture*) at all, why not quote correctly? I do not merely suggest that mode as likely to answer, but give it as the result of demonstrated experiment, and say positively that it is better than the common mode, but not equal to the mode by two stems (which I have described and elucidated by sketches), except on a low wall, because it does not produce so equal a division of sap. I have also described the principles and laws of nature upon which my different methods of training are grounded; and have proved, not only that the peculiarity which you term *the wary* is essential to the regular extension of the tree, but also (by a reference to the sketches), that, this mode being more conformable to those laws of nature, a tree by it may be brought to cover a greater space of wall, and to produce more fruit, in a less time, than can be done either by Hitt's, Forsyth's, or Knight's methods of training; and that the space of wall allotted to each tree may be more regularly covered with bearing wood, and be thus continued for a greater length of time, than can possibly be done by other methods: but you do not explain those laws. The sketch with two stems you have in another place given correctly; but there you say, "Heywood considers," &c., instead of giving my name, and explaining it to be a mode which I had successfully practised for many years, and found it in every way possessing advantages superior to any other mode of training the peach, because it promoted a more complete division of the sap, and produced a greater equality in the growth of branches. You also give a correct sketch of my mode of training from a single stem; but again treat it as a mere theory, by saying, "Heywood proposes," &c. And in another place you give correct sketches of my mode of training spiral dwarfs, but do not name me as the author. On training the vine, you treat me with great injustice: in § 2979, you give my name correctly, but the sketches you give are not mine, and such as neither resemble mine, nor fairly exhibit the advantages of my mode of training on the principles I have explained; which principles you do not explain, but you give sketches of Mr. Main's mode, which, although they nearly resemble mine, are but a bungling representation; and the merits of this mode rest entirely on my principles. Mr. Seton's plan, also, is grounded on my principles, and the success of his method must depend entirely upon their being strictly conformed to. Then, as my principles and mode of training the vine were published in vol. i. p. 172. of the *Horticultural Transactions*, am I not entitled to the merit of their first publication?

In your Magazine, Vol. VII. p. 687., you say, "The peach tree, trained as a specimen of Seymour's method, already covers a space of 30 ft. in length. Mr. Thompson, as we have before observed, considers this mode decidedly the best for peaches and nectarines, and we therefore are very desirous of repeating our recommendations of it. *It is the only decided scientific method that has ever been proposed, because there is a specific reason for the position of every branch and shoot of which the tree may*

consist." Undoubtedly, both you and Mr. Thompson are at liberty to prefer, and recommend, whatever system you think best; but my mode of training by two stems is also exhibited in the Chiswick garden; and you know that I have, in my book, not only given specific reasons for the position of every branch, but have explained the principles and laws of nature which render the position of the branches, as I have directed them to be placed, absolutely necessary, to produce that equal division of the sap which is essential to make the most of a tree trained within a given space. Then, how can you, who have quoted my book, feel justified in making such a public declaration as that above quoted in italics? Is it that your understanding of the term science is different from that which I have explained in your Magazine, Vol. V. p. 394.? You say, Mr. Seymour's mode is *most scientific*, because a specific reason is assigned for the position of every branch; but may not any person assign a specific reason for what he does, however absurd? And may not any one suggest a theory of the cause of an effect, however unfounded and erroneous? Now, I have not only assigned a specific reason for the position of every branch, but have explained the principles and laws of nature which constitute the cause of the effect desired to be produced: then, how can Mr. Seymour's method be more scientific than mine? You refer to Mr. Seymour's mode, published in your Magazine in the years 1825, 1826, and 1830; but my mode of training was published in a treatise in 1818, and laid before the Horticultural Society of London long before that time: it must be clear, then, that I could not have benefited by Mr. Seymour's mode and principles; but he possibly may by mine. The fair question, then, is, are the principles and laws of nature such as I have explained them? Or, has Mr. Seymour, or any other person, proved my notions to be erroneous, and his correct? If I am correct, it must result that Mr. Seymour can have obtained no advantages, by his mode of training, over mine, or any other method; but inasmuch as he has established the principles and conformed to the laws of nature (which I have explained) more correctly than I, or others, have done; and, if Mr. Thompson, or others, who have adopted my mode of training by two stems, have failed in perfecting my plan, it must have been occasioned by their having neglected, or not understood, those principles and laws of nature.

Although you and I may differ as to what constitutes science, it surely cannot be a matter of indifference to your readers whether they possess a knowledge of the science of horticulture, as defined by me, or not. However, to settle this, we will refer to Mr. Herschell's definition of science, as given in Lardner's *Cyclopædia*. He says, "The great, and indeed the only, ultimate source of our knowledge of nature and its laws is experience. But experience may be gained in two ways: either, first, by noticing facts as they occur, without any attempt to influence the frequency of their occurrence, or to vary the circumstances under which they occur; this is observation: or, secondly, the putting in action causes and agents (over which we have control), and purposely varying their combinations, and noticing what effects take place; this is experiment. To these two sources, then, we may look as the fountains of all natural science." Now, how does this apply to the subject before us? This author also says, "Arts cannot be perfected, until the whole processes are laid open, and their language simplified and rendered universally intelligible. Art is the application of knowledge to a practical end. *If knowledge be merely accumulated experience, the art is empirical; but if it be experience reasoned upon, and brought under general principles, it assumes a higher character, and becomes a scientific art.*" He further says, "The whole tendency of empirical art is to bury itself in technicalities, and to place its pride in particular short cuts and mysteries, known only to adepts; to surprise and astonish by results; but to conceal processes. The character of science is

directly the contrary. It delights to lay itself open to enquiry; and is not satisfied with its conclusions, till it make the road to them broad and beaten: and in its application it preserves the same character; its whole aim being to strip away all technical mystery; to illuminate every dark recess; and to gain free access to all processes, with the view to improve them on rational principles." According to those explanations, then, it cannot be supposed that either yourself or your readers can be indifferent to the diffusion, or the obtaining, of a knowledge of science; or that you can prefer empirical to scientific knowledge. But if you agree with me in thinking that what an ingenious author has said is just, viz., "That all discussion is the touchstone of truth, and is constantly necessary to prevent indifference, and to shake the overgrown influence of authority; and that by it whatever falsehood there may be in doctrines will be made to disappear;" you will give this an early insertion. In that case, as many of your readers may not have seen my book, or it may not be convenient to refer to it, I will, in your next, state certain principles, with exemplifications for discussion. I beg to add that I am the more desirous of thus establishing the truth, because I am confirmed in the opinion, that my notions of the principles and laws of nature, which constitute the science of horticulture, are correct, by the repeated experiments and constant observation of the thirteen years which have elapsed since the publication of my book; and because, believing that my former publication was neglected from its not being sufficiently intelligible for the generality of practical gardeners, I am about republishing the substance of it in a more simple form; that is, by question and answer, so as to form a *Horticultural Catechism*. This being the case, as I should be sorry to publish any thing as true that I did not believe to be incontrovertibly so, if it can be proved that I am in error, I will willingly submit to correction. I am, Sir, yours, &c. — *Joseph Hayward. Weymouth, Radipole, May 11. 1832.*

Planting Knolls in preference to Hollows. (Vol. VII. p. 413.) — Sir, If I am not much mistaken, you have laid down a rule in regard to planting knolls, in preference to hollows, which will not be found agreeable to the rules you profess to follow, viz. those of nature; wood being much more likely to establish itself in moist and sheltered hollows, than on dry and exposed elevations. But I do not mention this merely because I consider it a deviation from your general principles, but from the authority which it would seem to give for defacing one of the most beautiful objects under heaven, the green knoll. I will not say that knolls should in no case be planted; because where they are numerous, a darker covering to some would make the beauty of the others "beautiful exceedingly;" yet, with that exception, I would submit it as a rule, to spare

"The rapturous charms of the bonnie green knowes,
Ilk spring to be deckit wi' bonnie white yowes."

I am aware, however, how impossible it is to lay down minor rules, which would not in some instance of practice be subversive of the general principle that ought always to be observed in any attempt at ornamental planting, viz. to heighten the character of the scenery. However poor the situation may be, great improvements may be made in it by strictly following this principle. Are the dells insignificantly shallow? They may be deepened to the eye, if not in reality, by clothing their sides and summits with lofty trees; but remember to spare any little grass-green eminence which half bestrides the dell. Are the ridges and undulations tame? You may give them a bolder character by crowning them with wood: but take especial care that it shall not appear to have been *set on*, like an ill-made wig, upon the head of its owner. With regard to the outlines of woods, those most adapted for picturesque effect may be found in sinuous bays and jutting peninsulas, in isles and islets, with their coves and creeks. You will object to a single tree forming an islet; but I could not forego the

pleasure of seeing a magnificent tree fully relieved on a sea of pasture, for the sake of closely adhering to some fancied rule of nature, though I might and should observe your advice by not placing it in the centre of the ocean.

Before entering upon another subject, I cannot forbear to mention how very injudiciously the pruning-hook is made use of in ornamental plantations. By improper pruning they are made to appear more like groves of poles than masses of wood; and thus you may see though them, and into the clear daylight beyond, discovering, at the same time, the narrowness of their limits, which ought always, if possible, to be jealously concealed. Such poor substitutes for trees look miserably on a flat surface; and why their owners should be at such pains to mar nature I cannot conceive, since I am of opinion that perfection in plantations so situated consists in presenting to the spectator a mass of foliage, receding in gradation, with but partial variation, from a twenty feet tree to the loftiest of the forest. Shrubs and flowers ought not invariably to recede from the point of view in regular gradation of height, but should have, here and there, one elevated above its neighbours, differing both in colour and kind; and I apprehend it would be found practicable to arrange herbaceous plants, so that the decaying stalks of those gone out of flower might be concealed from view by those coming, or yet to come, into flower. This plan might be very successfully adopted towards pæonies, and many bulbous plants; and I would strongly recommend the practice to such as are in the habit of cropping their crocuses, or other bulbous plants immediately after flowering, without considering that leaves are as necessary for the preservation of a plant, as lungs are to the existence of a man. A flower-bed on a lawn, if studded with a variety of plants, should always have something throughout the flowering season, to which the eye will naturally revert, and not be so confusedly planted as to leave no impression either of individual beauty or harmonious assemblage. In aid of this, little bays or recesses, formed by the taller-growing plants, might be furnished with those of the procumbent or dwarf species, which would flower at a season different from that of the higher; for, if both were in flower at the same time, the dwarf species might very probably be overlooked, or suffer materially by comparison.

But, whatever plan be followed, let it be formed on the principle of plants rendering mutual assistance in exciting admiration; let each add to its neighbour's beauty, and not attempt a rivalry. I am partial, however, to the recess system, and would introduce into shrubberies, here and there, a little glade of dazzling splendour, to be approached through an interval of gloom. What admiration one of these would excite in early spring, if profusely gilded with crocuses, and surrounded with beautiful evergreens! Such a scene, when all around was bleak and comfortless, would make the heart leap up, and the eye moisten with joy; if that eye and heart belonged to one who prized flowers, and had a soul capable of appreciating the charms of nature.

In laying out a shrubbery, its effect in winter ought always carefully to be kept in mind; and it would be well, therefore, that evergreens should have the first preference of place; that such deciduous shrubs as are beautiful in spray or bud should have the next; and that these two should be placed in close neighbourhood, by one who has a painter's eye. I have already alluded to having early flowers beside evergreens, and would recommend such a disposition, not only on account of the additional beauty which each gives to the other, but for the sake of surprising and cheating the beholder into the idea of a more advanced season of the year. In shady situations, the crocus and the snowdrop might be greatly relieved by being planted in a bed of fleecy moss, which, besides being beautiful in itself, would have the advantage over grass of neither requiring the scythe, nor robbing the bulbs and shrubs of nourishment. There are two or three

things frequently to be met with in gardens, which are not exactly agreeable to my taste. The green-house, outwardly, presents an unsightly aspect, owing to the want of blank wall and ornamental shape; whilst, within, it is so crowded with plants, that you must walk sideways to prevent your arms from brushing down some of the pots to your feet, as you pass through its confined alley; and, should you wish to see the topmost plants of the stage, it can only be done with eyes painfully strained. Now, in buildings of this kind, economy should not be the first consideration; and, therefore, though some slight inconvenience might arise from three detached houses, such a number, formed on architectural principles, with intervening blank walls, adorned with evergreens, would amply compensate, by their ornamental appearance, for any disadvantage of separation. Very small green-houses might be conveniently and ornamentally attached to cottages, so that the parlour window might command a view of the gay interior, which, from its smallness of scale not allowing of an alley, might always be viewed from without. Then, the long painted sticks, to whose tops the neighbouring plants have yet to climb, have an unsightly appearance: this might be remedied by procuring tubular supports, to be inserted in each other, as the growth of the plant required. Last of all, I will mention box-edgings, and all other too scrupulously defined border-lines, as not agreeing with my taste; preferring rather an occasional encroachment on the path by some recumbent* plant, such, for example, as the *Eschscholtzia californica*, which would offer its golden goblets to the sun with great effect in such a situation. — *R. T. F. — Cottage, Oct. 31. 1831.*

Larch, Pine, and Fir Timber will resist Fire while green, or full of Sap. — I find it stated (p. 93.) that “the timber of the larch, though, like other trees of the fir tribe, it abounds with turpentine, is yet, contrary to what we should expect, remarkably slow in igniting, and may almost be said to resist fire.” Is not the timber of all the fir tribe equally difficult to ignite before being dried? In my humble opinion it is. The settlers in America know from experience, that there are no logs so difficult to burn as those of the fir tribe: I have had some experience of this, myself, in Upper Canada, where the hemlock spruce (*Abies canadensis H. K.*) and white pine (*Pinus Strobus L.*) are not uncommon.

With regard to the American black larch (*Larix péndula Lambert*), when dry, it is greatly in demand as fuel for the steam-boats on the St. Lawrence. I recollect enquiring of the engineer of a steam boat why he used tamarac, the Canadian name for larch, in preference to maple, hickory, or beech. He replied, that it gave out more flame, and burned quicker, and was for these reasons preferred; yet, from what I have experienced, there is no species of timber in Canada which will give out more heat, or last longer as common fuel, than beech, hickory, or maple. The two last-mentioned burn as well when green as when dried. I am, Sir, yours, &c. — *T. Blair. Stamford Hill, March 7. 1832.*

The wood of the common ash (*Fraxinus excélsior L.*) is said to burn freely in a green state; and there is an adage to this effect in words like these: — “Ash while green, Is fit to burn before the queen.” Does it burn so freely? — *J. D.*

The Common and Highland Pines. — Sir, In J. G.’s very useful and interesting account of the common and Highland pines, found in Scotland (p. 10.), I regret that he has not pointed out more precisely the botanical characters of each, so as to enable your readers to distinguish the one from the other. After noticing the superiority of the “new sort,” as timber, “in size, quality, and durability,” the chief points he speaks of, in which it differs from the “old,” and less valuable kind, are “its long tufted leaves, and the horizontal direction of its branches;” and these, he informs

* The word is here used to signify a posture betwixt standing up and lying down; and not, therefore, in the sense of *procumbent*. — *R. T.*

us, are sufficient, in the opinion of Mr. Don of Forfar, to "constitute a distinct species, which might with propriety be termed *Pinus horizontalis*." An accurate knowledge of these two species or varieties (be they which they may) is of the highest importance to all engaged in the pleasing occupation of planting, and must also prove interesting to the mere botanist. As J. G. intimates his intention of recurring to the subject at a future period, I would suggest that his next communication should be by all means accompanied with botanical figures of the two kinds of Scotch pine, and with a more full and detailed account of their distinctive differences. Yours, — B. Coventry, Feb. 15. 1832.

One of our most intelligent correspondents, A. G., Perthshire, speaking of the article referred to by B. on the Scotch pine, in a provincial newspaper, says: — "Of the Scotch pine, like the other species of forest trees, there are numerous subvarieties; and the timber, as well as the external appearance, of what some term *Pinus horizontalis* is different from that of the commonly cultivated Scotch pine; but, as this variety or species bears little seed, its culture has hitherto been limited, compared with other more prolific seed-bearing varieties, of which a practised eye can easily detect several in every Scotch pine plantation." (*Dundee, Perth, and Cupar Adv.*, March 8. 1832.)

Mr. Pearson's Treatise on the Fig. (Vol. VII. p. 325.) — Mr. Pearson says he has seen very little about the cultivation of fig trees in your Magazine: now, I ask him if he thinks what he has written about them will give what he terms a sluggish or ignorant gardener the least information about figs. I think what he has written on figs is like washing without soap; as he has said nothing from which the reader will be able to draw any general information on the subject. Mr. Pearson takes no notice of the management of fig trees in a hot-house, but makes a great din about some trees that he has on an old stable wall: the one part of his writing also contradicts the other, as he first says that the fig is an aquatic, and in the same sheet tells us he lost a crop in a wet season. His method of pruning is simple enough, as every cabbage gardener would know that he should take out wood which was getting above the wall. I can guess the reason Mr. Pearson's fig trees require so much water. From the description he gives, I should suppose them to be a hundred years old; and in that case, the root of the fig being very tenacious, the soil must be so completely exhausted, that his trees will have little other nutriment but water. The trees, from being old, and covering a great space of wall, will be naturally of humble growth, making short-jointed wood, which is always most fruitful in fig trees. If, however, Mr. Pearson had trees eight or ten years old, planted in a well-prepared border, under his management, and gave them the quantity of water he gives the trees at Ormiston Hall, he would have no fruit, as the trees would send forth luxuriant, spongy, and unfruitful wood. I have seen trees of this description which required to be kept very dry, and ringed in the bark, to humble their growth, and bring them into a bearing state. With regard to fig trees in the open air, after the winter covering of fern or spruce fir branches is taken off in April, I would prune them; examining the branches closely, so as to leave in the wood which has most fruit in it, which is known by the leaf and fruit-bud being seen at the same joint; and would never shorten any but where bottom wood is wanted. Fig trees in hot-houses, however, require different treatment; as what fruit they show on the last year's wood they drop off, and only ripen their fruit on the wood made the same season; the object in pruning them is, therefore, to leave such branches as are most likely to push forth fruitful wood, which invariably springs from short spurs of three or four joints. I am, Sir, yours, &c. — John Smith, Journeyman Gardener. *Beaufront, near Hexham, Jan. 21. 1832.*

Many years since, a fine old fig tree occupied one face of a tall wall in the garden at Hardwicke House, near Bury St. Edmunds. Parallel to the

wall, but at the distance of about 20 ft. from it, was a pond of water, the space between being occupied by a border and walk : the soil a stiff, or even slightly clayey, loam. Mr. Barrett, the gardener there, a man celebrated in the neighbourhood for his skillful culture of wall and other fruit, has informed me that this fig tree used annually to bear a copious crop of delicious fruit ; and this fecundity Mr. Barrett imputes to the contiguity of the pond, into the mud and water of which the roots of the fig tree had made their way, as by duly scrupulous examination he had fully satisfied himself. In transcribing this fact from my memory, I will not vouch for having remembered the width of the border with accuracy ; but the broad facts of the fig tree's fecundity, and the connection of its roots with the water in the pond, may be fully relied on. The fig tree has long since been displaced, and the pond filled up ; but the facts are still fresh in the memory of Mr. Barrett, who ever cites them when the culture of figs is conversed on ; because, as Mr. Barrett remarks, they oppose the commonly received opinion of the fig's affection and preference for a dry border and calcareous soil. The remarkable vigour evinced by *Ficus stipulata* Thunberg, when its roots had access to a cistern filled with water, as will be hereafter described, may also be a fact more or less relative to the question at issue.—*J. D.*

The Tea Plant.—Mr. Murray (p. 89.) may rest assured, that whatever I may have written relative to the manufacture of tea was derived from the best authorities, viz. Messrs. Duncan and Arthur, the former physician to the Company's officers, and the latter inspector of tea at Canton in 1794. But lest these gentlemen may have been mistaken, I present the following extracts :—“ The Chinese all agree there is but one sort of the tea tree ; and that the difference in tea arises from the soil and manner of curing.” (F. Pigon, Esq., in *Asiatic Register*, 1809.) “ This fact is farther confirmed by Lord Macartney and Sir George Staunton.” (See *Macartney's Embassy to China*, vol. iii. p. 296.) As to the Tartars knowing little of black tea, this may be accounted for from another remark in Mr. Pigon's paper, viz. “ The tea sent into Tartary is mostly *green*, in the proportion of seven to two.”—*J. Main.*

Thèa viridis is figured in the *Botanical Magazine* for April, t. 3148 ; where it is well remarked, and reasons why are adduced, that *Thèa viridis* must be specifically distinct from *T. Bohèa*: the only astonishing fact is, that a contrary opinion could ever have prevailed. Almost two pages of text are offered on the interesting question, From how many or how few distinct species or varieties of tea plant are the teas of commerce derived ? But, although contributions towards an answer are adduced, no positive answer is presented : in fact, Mr. Main's excellent article (Vol. IV. p. 454.) anticipates all that is adduced ; except that, in the article of the *Botanical Magazine*, Mr. Hooker's informant (Charles Millett, Esq., of Canton, who holds a high official situation in the East India Company's factory there) states that the teas are derived from two species of tea plant, but that all the varieties can be made from either species. Dr. Hooker quotes Dr. Abel in corroboration of this view ; and, from the quotation, it appears that Dr. Abel deems the two kinds of tea plant spoken of to be the *Thèa Bohèa* and the *Thèa viridis*. The words quoted from Dr. Abel are these :—“ From persons conversant with the Chinese method, I learned that either of the two plants will afford the black or green tea of the shops ; but that the broad thin-leaved plant (our *T. viridis*) is preferred for making the green tea.” Dr. Hooker follows these quoted opinions, by remarking that “ Kæmpfer's figure of the Japanese tea plant, which is evidently the plant in general cultivation in that empire [in which Kæmpfer travelled], is of the *Thèa Bohèa*, not the *Thèa viridis*.” After stating that the geographical range of the tea districts in China is very extensive, and showing that sixty cognisable kinds of tea are manufactured, Dr. Hooker remarks :—“ All these different kinds of tea may be distinguished, by the experienced merchant, merely by the taste. The situation of assayer of teas, at Canton,

requires this sort of talent ; and the individual who holds it enjoys a salary of 1000*l.* a year for tasting teas only.”

“ The quantity of tea produced in China must be enormous ; for, with the exception of Japan, a province of China, it has not been found practicable to cultivate it to advantage any where but in China Proper ; and there the tea plant is spread, and not very thinly spread, over a square area of 1,372,450 square miles. It is now a common beverage throughout the whole civilised world ; and its use in China reaches to a very high antiquity.”

The frequent attempts to cultivate the tea plant in Brazil and elsewhere (see *Gard. Mag.*, vol. i. p. 332., and Vol. IV. p. 276.), Dr. Hooker represents as having been found impracticable ; that is, to an extent adequate to the purposes of commerce, “ mainly on account of the higher price of labour.”

“ Little more than a century ago, according to Lord Macartney, the English East India Company did not sell more than 50,000 lbs. of tea, and very little was smuggled. In 1784, the consumption of Great Britain was estimated at 13,338,140 lbs. Now [1832], that of Great Britain and Ireland, exclusive of the dependencies, amounts to 28,000,000 lbs. America carries on a vast trade in this article ; but Russia is stated to rank next to Great Britain, inasmuch as 25,200,000 lbs. of tea are yearly imported and consumed by the Russians. In consequence of the contiguity of Russia and China, the Russian imports of tea are by land ; and tea obtained thus promptly is said to excel in quality that subjected to a long voyage.”—*J. D.*

The Culture of Trevirana coccinea, or Cyrilla pulchella. (Vol. VII. p. 570. and 605.)—Sir, At Vol. VII. p. 570., you recommend to my regard *Trevirana coccinea* : but I beg to tell you that this charming plant has long exercised its lovely fascinations on my sensorium ; and its attractions are, it appears (Vol. VII. p. 605.), also felt by “ An Amateur.” I, nevertheless, differ in opinion from the Amateur, who deems it objectionable to plant the tubers separately, and advises that every old ball of tubers should be cut into four quarters, and that each quarter should furnish one pot. In proof of what the individual tubers are capable of, planted one in a pot, in one season, I send you an account of a plant now blooming here in a pot 5 in. wide, produced from an individual tuber : it is 1 ft. 8 in. high, and 2 ft. in diameter, and forms a complete pyramid. The flowers now open are in number 257 ; they are in great perfection as to colour, and in size are generally three quarters of an inch in diameter. I am, Sir, yours, &c.—*Thomas Appleby. Horsforth Hall Gardens, Nov. 4. 1831.*

Cultivation and Cure of Tobacco.—Sir, The attention of your readers is directed to the subject of the cultivation and cure of tobacco, by E. S., p. 42. Its efficacy in destroying various insects, without injuring vegetation, is well known, when properly applied ; but I think, by the method recommended by E. S., the tobacco must burn too freely, and the smoke will be consequently hot, which I am sure is injurious. The object should be, to produce the greatest quantity of smoke from the tobacco used ; and this, I believe, is what is generally aimed at. It is a subject, however, deserving the attention of gardeners, on account of its usefulness, especially as the cultivation of tobacco is very simple. It requires, indeed, nothing more than to be sown in a little heat, about the middle of March, and to be protected during the continuance of frost, or until about the middle of May, when it should be planted in good rich soil, leaving plenty of room to grow ; say 2 ft. from row to row, letting the plants be at least 2 ft. apart. It is very essential that the plants should not be crowded, or the leaves will be thin and weak. Before the plants blossom they should be topped, and the side shoots kept broken off as soon as they appear. As soon as the leaves come to maturity, I prefer cutting the plant down, and letting it wither and dry in the shade before stripping off the leaves, which should be dried carefully, but not too slowly. The process of heating by fermentation should, I think, be only sufficient to destroy the greenness of the leaf (the

greatest danger of spoiling it being by heating), and after this operation has been performed it should be again well dried. The best way to keep the tobacco, when properly prepared, is to press it closely into a box where it will be excluded from the air, and which should be placed in a dry situation. Managed thus, it will answer the general purposes of fumigation required in horticulture; but will certainly not be equal to that imported. — *A. N.* March 3. 1832.

Italian Practices with respect to the Culture of Sweet and Bitter Oranges, and of Lemons. (Vol. VII. p. 308—310.)—Permit me to rectify some of the notices on sweet and bitter oranges communicated by W. Spence, Esq. F.L.S., and inserted in Vol. VII. p. 308—310. That gentleman, after having said that on the shores of the Lakes Maggiore and Garda, the orange and lemon trees, although planted in the open ground, are covered in the winter with wooden tents, which, in very severe frosts, are warmed with artificial heat, announces as a fact that there is no place that he knows of, in the north of Italy, where the sweet orange can remain uncovered in the open air during the winter, beyond the neighbourhoods of Pisa, Massa, Genoa, &c. I can certify that, on the shores of the Lake of Como, which is more northerly than the Lake of Garda, and particularly at Varenna, in the garden of Casa Isambardi, not only bitter oranges, but sweet oranges, are left uncovered in the open air all the winter. They only take the precaution, when they expect a fall of the thermometer to 4° of Reaum. (23° of Fahr.), to gather the oranges, because, being exposed to 4° of cold, they freeze, and become unfit for food; and being gathered, if they are not speedily sold, they are placed in cellars in wine vats, where they are preserved fresh till spring. I have also happened to see, that, in winters even colder than 4° , when some oranges have accidentally escaped the notice of the gardener, they have remained uninjured throughout the winter on the tree.

What Mr. Spence relates of covering lemon trees on the shores of the Verbano and of the Benaco is, however, practised on those of the Lario; though this caution is more useful for the preservation of the fruit than of the plants. I, who am a native of Varenna, and have lived there for many years, have seen lemon trees planted in places exposed to damp winds, standing the coldest winters (relative to that country) without any shelter. Their fruit, however, was a little withered by the frost, and the leaves and the uppermost twigs were discoloured or blighted; but they suffered in no other respect. This particular hardness, in my opinion, arises from the circumstance of these plants having been from their infancy exposed in the winter without covering of any kind. If, on the contrary, they had been accustomed from the beginning, like their sister plants, to be sheltered from the cold, I think that, if exposed afterwards in such situations, they would have been blighted or injured by the frosts. Thus, in my present neighbourhood, at Monza, the vine stands very well the severity of the winter, without being laid down and covered with earth, as is proved by a number of old vines climbing round the trees, the vine arbours, and the vines trained on espaliers, none of which are ever buried. On the contrary, all the vines planted in rows are buried; and, if these should by chance be left erect during the winter, they grow unhealthy or die, either from the cold or the fogs. The late director of the gardens and park at Monza, Sig. Luigi Villaresi, procured from Bordeaux and Burgundy some vines which he placed on a hill in the park: during his lifetime these vines were never laid down under ground, notwithstanding which their vegetation was always flourishing and their vintage copious. At his death, through the obstinacy usual in ignorant peasants, and in stewards not better instructed than the peasants, these vines were buried like the rest; and, would you believe it? they have now become so sensitive to the rigours of winter, that, if they are not well covered, they look yellow and sickly the

next summer, and, what is worse, their berries are neither good nor abundant. But let us return to the first subject.

On the Larian hills, in frosty nights, the wooden houses, or rather tents, which enclose the lemon trees, are heated; but do you know how? One, two, or more fires are lighted, according to the size of the orangery (*agrumiera*). The fuel is either wood or charcoal, and it is lighted, not in a stove brought for the purpose, but on the floor of the orangery; and thus the plants are all more or less exposed to the smoke; which, being composed of carbonic acid, acetic acid, carbon, water, and oil, and coming in contact with the leaves, the cellular tissue of the fruit and the tender buds and leaves are so disorganised by the action of these acids, that they fade and fall off.

Considerable profit is made by the cultivation of lemons on the Larian hills. A single plant in the open air, well grown and well cultivated, yields every year not less than 200 lemons. I have even seen one, the trunk of which was a foot in diameter, which produced no less than 500 lemons every year. The lemons were sold at from 6s. to 10s. per hundred, according to their size and the quantity of juice that they contained, and according as the harvests on the shore of the Lake of Garda and in the neighbourhood of Genoa were more or less abundant. Bitter oranges are sold usually at about 2s. the hundred. The sweet at the same price as the lemons, and sometimes less; their sweetness being, as Mr. Spence observes, less exquisite than that of the oranges of Malta. The use that is made of the bitter oranges, in this part of Italy, is to make a pickle of them with mustard.

If the proprietors of the warmer declivities of the Larian hills understood their interests better, they would raise plantations of bitter oranges, to use them as stocks for grafting for the various species of lemons; because the lemon grafted on the bitter orange resists the cold better than in its natural state: like the medlar of Japan (*Eriobótrya japónica Lindl.*), which, when grafted on the whitethorn (*Cratægus Oxyacántha L.*), acquires additional strength, and the true pistachio (*Pistácia vera L.*), which, when grafted on the turpentine tree (*Pistácia Terebínthus L.*), resists the cold of 8° Reaum. (14° of Fahr.); while, if grown from the root, it dies at 5° (20¾° of Fahr.). (See *Sageret, Pomologie Physiologique*, pp. 16, 17.) The constitution (so to speak) of the lemons being strengthened in this manner, the tree may be left standing in the open air, even in the depth of winter. The cultivators of Nerva and of Monaco, in the Genoese territory, understand this method of cultivating the lemon. Originally even they covered the trees in winter with wooden sheds, and they raised the plants from the root, propagating them either by seed or by layers (see *Observations of an Associate of the Academy of the Giorgofli Fiorentini, on the Cultivation of the Agrumi*, Florence, 1767); but, by dint of observation, they were aware that it was necessary to try other means, and the result of their experience led to the method of treating the orange and lemon trees which Mr. Spence has pointed out to you. It is true that some of the fruit would probably be frozen on the occurrence of a very severe winter: but this evil would be trifling, compared to the advantages derived from the method of cultivation practised by the Nervans and Monacoans; and the loss sustained might be diminished by gathering the frozen lemons immediately, and submerging them in water at 0° Reaum. (32° Fahr.), by which, their tissues thawing gradually, they would become as good as at first.

Cultivation of the Pine-apple in the open Ground, in the North of Italy. (p. 70.) — I can as yet say nothing satisfactory on the cultivation of the pine-apple in the open ground. For two years I have sent some crowns to a gardener on the Lake of Como, confiding to him the care of the experiment; and though these plants perished, I think it was from having been watered too often and too much. Still, however, I am convinced that, if treated carefully, and perhaps even if left to themselves, pines

would, in many warm parts of the Larian hills, succeed well in the open ground. The arguments upon which I found this opinion are, 1st, That in the stoves of Count Mellerio's garden at Gernetto, near Monza, the thermometer is suffered to fall in the winter to 1° Reaum. ($34\frac{1}{4}^{\circ}$ Fahr.), without the pines suffering in the least. 2dly, That the pines being planted in the open ground would become more hardy and strong (as may be inferred from what happens to other plants under similar circumstances), and consequently better able to resist the cold. 3dly, That on those declivities of the Larian hills where I think the pine-apple might be cultivated in the open ground, the thermometer of Reaumur, even in the middle of winter, rarely descends lower than 3° ($25\frac{1}{4}^{\circ}$ Fahr.); and 4thly, Because my late father, having planted a pine-apple plant in a court open to the sun, in a garden at Varenna, it continued growing for two years, although exposed continually to the open air; and it only perished through the carelessness of a mason, who threw a large slate on it from a roof, by which it was broken. Many will laugh at hearing that I propose to cultivate the pine-apple in the open ground, at 46° north lat.; but I ask them, in return, if they have never heard that they cultivate figs in the Shetland Islands; and remind them of a fact observed by St. Pierre:—"J'ai vu en Finlande, près de Vibourg, au-delà du 61 degré de latitude, des cerisiers en plein vent, quoique ces arbres soient originaires du 42° . (*Etudes de la Nature*, vol. ii. p. 485, 486.)

Culture of the Pine-Apple in the Garden Stoves of the Neighbourhood of Monza.— Since I cannot give you any satisfactory account of the cultivation of pine-apples in the open ground, I will inform you, at least, of the manner in which they are grown in the stoves of the gardens in this neighbourhood. I have already mentioned that some of our gardeners let the temperature of their stoves fall in the winter, sometimes as low as 1° Reaum. ($34\frac{1}{4}^{\circ}$ Fahr.). Do not suppose that by this want of attention the pines suffer; for it is with these very gardeners that I saw the finest pines. But what must give you pleasure is, that, from notices taken from your Magazine, pines have been planted for the last two years in the open ground in the gardens of Casa Traversi, at Desio, three miles' distance from Monza. I mean to say, however, in the open ground of the stoves, where they are disposed in rows about 2 ft. apart, the plants being about $1\frac{1}{2}$ ft. distant from each other. Would you believe it? after this treatment, the plants grew so vigorously, that they fruited pines of the weight of nearly 4 lbs., while at first the greatest weight was scarcely three quarters of a pound. The variety here cultivated is the pyramidàlis; though its dimensions increase so much when it is cultivated out of the pots, that it appears one of the larger varieties: it is sufficient to say that one of its leaves has attained the length of not less than 6 ft., displaying a proportionate thickness.

Flowers and Tips of the Branches of Gourd Plants excellent Food.— In some part of your Magazine, you have mentioned that gourds not only produce useful fruit, but that their tops also afford excellent food. This fact agrees exactly with the custom of our peasants, who, after having eaten the fruit, or having employed them as forage for their cattle, pick off and cook the tops, which taste better than the fruit itself; but the flowers are even better and more delicate than either the fruit or the tops. My father, a Florentine gardener, told me that it is the custom in Tuscany, particularly in the families of the country people, to gather the male flowers of the gourd, with a little of the stalk, before they are fully blown; and, having dipped them in paste of wheat flour, to fry them in butter or oil. This is considered so excellent a dish in Italy, that it is usual to say, speaking metaphorically of a thing which is not particularly good, "Non è fior di zucca." [It is not the flower of a gourd.] In Lombardy, also, several varieties of gourd are known; and one is now spreading itself in our gardens, called

zucca santa, or zucca di Gerusalemme, and vulgarly zucca boruffa, which exceeds in goodness all the others. The fruit of the Jerusalem gourd assumes, in ripening, a deep yellow tinge, like the colour of a brick; in form they might be compared to the zucca lagenaria (bottle gourd), if they were not bent; the pulp is thick, and slightly watery. When ripe, they may be easily preserved in a dry place, not colder than 2° Reaumur (36½° Fahr.), during the whole winter. Cut in pieces, and fried with butter, they have a very sweet and delicate flavour.

Size of the Fruit of some Kinds of Gourd in Italy.—The size to which the fruit of some of the Cucurbitaceæ arrive in our country, when they are well cultivated, is enormous. If you have read our 105th *Agronomo, il Tanara*, the following account must have astonished you:—“It is better to cultivate two plants of this species (speaking of the creeping melon, *popone rampichino*), than twenty of the others that are on the ground. First, because one plant produces more melons than ten of the ground species; and I have had one plant which had grown twenty-five to such a size that it was necessary to support them with sticks put under them, besides the boughs upon which they were trained; and on another plant, near to this, I had one which a large tub (*bigoncio*) could not contain! I sent it to the palace, carried on an ass,” &c. How astonished I have been at the immense mass dug up from the batata (*Convólulus Batatas* L., *Ipomœa Batatas* Poir.), about which Mr. Hall has written to you from the country of the Illinois (Vol. I. p. 329.); and which, when carried to the fire, was scorching at one end, while a man was seated on the other extremity, flourishing his legs about at his ease.* However, I can assure you that, even in Lombardy, when all the circumstances are favourable to the developement of the gourds, it is not unusual to see them so large as to weigh each 120 lbs. (207 lbs. avoirdupois). Fruit of this size is produced almost entirely from a variety of gourd called vulgarly *zucca marina*. The cultivation of gourds deserves to be more extensively and carefully practised than it is at present by us (for, to say the truth, it is very limited), on account of their abundant produce, especially of one variety with cylindrical fruit, and yellow pulp and skin. In fat and loamy soils, the fruit of this plant affords an excellent forage for cows in the winter. The seeds, which in every gourd of the above-mentioned variety generally exceed 500, yield a sweet oil, excellent for the uses of the kitchen; and the stems and overplus leaves make a manure which would much improve our soils. The soils desirable for the cultivation of gourds should be planted with Indian corn; because the gourds being cultivated with that plant in alternate rows, afford sufficient shade to defend it from the heat of summer, which, in dry grounds, often proves fatal to the Indian corn. All these advantages are overlooked by our stewards, even as they overlook, from ignorance, many others of the greatest moment.

Since I have mentioned the batata (*Ipomœa Batatas* Poir.), tell me, I beg of you, what success attends its cultivation in England. I tried to grow this plant on the banks of the Lake of Como: the produce was tolerably abundant, although, aiming to introduce it into the agriculture of that district (similarly to what has been doing in Portugal), I had treated it like the potato (*Solanum tuberosum* L.). I was very anxious to force it to flower and fruit, imagining that, from the seed, I should have obtained varieties which might be more easily naturalised to our climate than the parent plant; since, so long as its roots are so delicate as only to be kept in the winter, by being packed in cases, between layers of very dry sand, and placed on the *cappa* of the kitchen chimney, its cultivation in Lom-

* Dr. Maurelle also saw, in the Island Lattè, batatas as thick as a man's thigh, and 15 ft. long. (*Voyages of La Peyrouse*, vol. iv. p. 230. Italian transl.)

bardly will be always limited to the gardens of rich noblemen.* Unfortunately for the success of my experiment, I was appointed, exactly at that period, to the employment which I now fill; and I was therefore obliged to give up my trials, which I have never since been able to resume.

In my attempts to flower and fruit the batata, I intended, first, to prevent as much as possible, or at least to retard, the increase of the tubers; it being known that, in bulbous or tuberous rooted plants, the development of the flowers and fruits is in inverse proportion to the development of the roots: 2dly, to stimulate as much as possible the vegetation; placing the plants in calcareous and half-burned soil, and manuring them with sea-salt, the grounds of grapes pressed for wine (vinaceie), and dried blood; knowing, not to mention the effects of the sea-salt, which has been treated of in several Numbers of the Gardener's Magazine, that the sediment of wine, if used in the cultivation of vines, will excite them so much to fructification, that, if the dose be not moderate, in a short time they are weakened; and also that manuring of gillyflowers with it accelerates the flowering beyond measure (see Conte Filippo, *On Manure*, 2d edit. p. 90.); and not being ignorant, with respect to dried blood, that its fertilising property is superior to that of the urine, dung, or even the muscular flesh of dead animals: 3dly, to graft, after the manner of Tschudy, the buds or young shoots; remembering that Cabanis (*Essais sur les Principes de la Greffe*), by grafting peach trees $2\frac{1}{2}$ months old, obtained fruit from them only $24\frac{1}{2}$ months from the time of planting them: 4thly, to keep the plants from the ground, training them against a wall painted violet colour; the influence of the violet rays being remarkably favourable to vegetation (Vol. IV. p. 451.): 5thly, to bind them at different heights with bands of wool or other material, to stop the current of the descending sap: 6thly, to prune them till they were only about one half or two thirds of their natural length; for it is by such an operation that, with us, camellias are flowered, and that the *Phaseolus Caracalla* L. is made to produce copious flowers and legumes †: 7thly, to deprive the plants of water till the leaves fade, and are almost dry, and then to water them abundantly; this being the method we take to flower the *Alstrœmèria Ligtu*: and, 8thly, to take the cuttings in autumn, that is, when the shoots or stalks are full grown, since it is a remarkable fact, that plants raised from such cuttings sometimes flower sooner than the mother plant ‡; and to treat them, during the winter and the ensuing year, in the same manner as I had previously done the parent plants. By the last means alone it is said that M. Vallet has already obtained flowers from the batata, but not seeds. No doubt you have long since tasted the tubers of the batata; I have only tasted those of the white variety, which are reckoned inferior to the others; however, cut in pieces raw, and fried with butter, what a delightful dish it is!

Cultivation of the Mulberry Tree, and the Breeding of Silkworms in

* M. Vallet, nurseryman, of Rouen, preserves the roots of this plant in any substance, provided it be dry, and kept constantly at a temperature between 8° and 12° Reaum. (50° and 59° Fahr.).

† A serious objection to the efficacy of this process might be deduced from the censure of Bose on the practice of decimating the creeping French beans (see *Nouveau Cours complet d'Agriculture Théoretique et Pratique*, art. *Haricot*); but on this subject permit me to state my justification, when I shall speak of the cultivation of the *Phaseolus Caracalla* in the gardens of Lombardy.

‡ The first flower of the *Rhododéndron arboreum*, seen in Lombardy, was observed at Desio, on a plant grown from a cutting. Close by was the parent plant, which had never flowered, nor given any symptom of being likely soon to do so.

England.— I am also curious to know what progress the cultivation of mulberry trees and silkworms is making in England. In Lombardy there has been lately introduced a new species of mulberry, which is said to be originally from the Philippine Islands. The leaf is 9 in. long, and 6 in. broad; it is sometimes called *Morus cucullata*, from the leaf itself being formed like a *cartoccio* [papers used by grocers], and sometimes *Morus multicaulis*, from the number of stems which rise from one root. It increases more vigorously than any other species, the shoots of one year's growth attaining the height of 7 ft. As plants which increase very rapidly are scarcely ever injured in a damp and humid soil, I am of opinion that this would be the species of mulberry most suitable to England: the colds of England would not injure them; as, when at Turin, they stood in the winter of 1829-30, a cold of 16° Reaum. (7° Fahr.) This species of mulberry is especially adapted for forming hedges. It yields, in a very short time, a greater quantity of leaves than any other species; it scarcely ever fruits, but is pretty easily propagated by means of cuttings, of which, if you desire any, let me know, for I shall have much pleasure in serving you. [We thank our correspondent, but have seen them at Messrs. Loddiges.]

The silk harvest was very scanty this year in Lombardy, on account of the lasting rains which fell in the spring, and made the leaves of the mulberry trees wither. On the contrary, the olives yielded an extraordinarily abundant crop. While I am writing, I have received an account from Lario, that the gathering of the olives, which commenced in the beginning of December, is now scarcely finished. Well-cultivated olive grounds will produce, for every perch (one fifth of an acre), not less than fifteen bushels of olives, and these, at the mill, will yield 105 pounds avoirdupois of oil, which is worth no less than 30 soldi (about a shilling) per pound. The cause, in my opinion, of the unusual fertility of the olives this year was the same that occasioned so much havoc to the silkworms; I mean, the abundant and frequent rains which fell after June, that is, after the flowering of the olives.

Cobbett's Indian Corn, and a Kind grown in Lombardy.— I have read in your Magazine, and also in the *Political Register* of Mr. Cobbett, of a sort of Indian corn, named after the celebrated politician who introduced it first into England. Two years ago, a variety or species, originally from California, was introduced into Lombardy, which is very early, and produces two ears on each stalk, each containing 700 or 800 grains, small, but more transparent than I have ever seen in any other kind of maize. In the mill it makes very little bran, and yields a great deal of flour, which is said to have more flavour than the other sorts. Its distinctive characters were thus defined by Signor Bonafous of Turin:—"Zea, foliis hirtis et dependentibus; spiculis masculis sessilibus, diandris triandrisve: antheris subauricis." Can this variety or species be the same as Cobbett's corn? If it is not, I will send you the seeds of it, that you may distribute them to different cultivators in England, from whom I will receive, with gratitude, some seeds of Cobbett's corn.

Mr. Gauen's Mode of heating Air by Lenses, for promoting the Processes of Vegetation. (Vol. III. p. 10.)— I was much interested in Mr. Gauen's idea (Vol. III. p. 10.) of heating with lenses, mounted on a suitable frame, which should continually present to the sun immense masses of air, or, as you propose, water. The late professor of natural philosophy (fisica), in the Lyceum of S. Alessandro, in Milan, Signor Antonio Crivelli, had contrived a cone or trunk of brass, or I should rather say a cone terminated in a calotta [?], with which he so concentrated the rays of the sun, as to carbonise a diamond. By varying the relation between the height and the length of the cones, he varied also the distance of the focus? so that he could inflame an object at the distance of 40 or 50 ft. Buffon, having constructed a system of burning glasses, supposed that it was the same

contrivance as that adopted by Archimedes for setting fire to the Roman fleet; but Professor Crivelli, arguing that it would require half an hour to adjust a set of glasses like those described by Buffon, so as to carry fire to the spot where the Roman fleet was placed, showed that it was much more probable that Archimedes had rather made use of an instrument like that invented by himself, which he denominated a conio ustorio, by which the burning of the fleet might have been effected in a moment. Passing over these hypotheses, you will perceive that the cono ustorio of Professor Crivelli might be efficacious in attaining the object that you have proposed, in the remarks you have appended to Mr. Gauen's communications. Professor Crivelli, in dying, divulged to one of his friends the secret, or rather the rules, for constructing these cones; but I am sorry to state that the invention is still jealously concealed. — *Luigi Manetti. Monza, Feb. 26. 1832.*

Fingers and Toes. (p. 325.) — I observe, in your extracts from the *Memoirs of the Caledonian Horticultural Society*, a notice of this injury to which most of the cabbage tribe is subject. The insect that causes these malformations is called by entomologists Nédejus contráctor. Its attack can only be averted by making the plant offensive to the parent fly; and this, it has been lately discovered, can be done by incorporating with the soil soapboilers' waste, or any other substance of similar alkaline quality. Since this discovery has been made, the price of this waste has risen, in the neighbourhood of London, I am told, from 6d. to 5s. per cart-load. Besides partridges preying on the larvæ, I have often seen magpies, crows, and, if I mistake not, even rooks, doing this useful service. — *J. M.*

Leaves, which should be deciduous, remaining, although dead, through the Winter, on Fruit and other Trees. — At p. 358. it is stated that, in Normandy, children go about with lighted torches of rye straw, "for the purpose of burning the lichens, mosses, and dead leaves, on the apple trees." Without offering an opinion on the merits of any mode for removing the persisting dead leaves, it may be safely remarked, that to remove them is most judicious and desirable. Such dead leaves, on examination, will commonly be found to be but the envelopes of so many clusters of eggs or pupas of insects, which the sunshine of spring will excite to life and voracity, just at the time that the expanding leaves of the trees have become eligible food for their sustenance. — *J. D.*

The Power of the Honey Bee to produce a Queen. — Sir, Having seen, by Mr. Huish's remarks (p. 375.), that the Society for the Diffusion of Useful Knowledge has published an account of Huber's experiments on the power of the honey bee to produce a queen from the maggot of a working bee, I wish, for the sake of the memory of Huber, whom I hesitate not to designate the *prince of apiarians*, to set my humble seal to the truth of that wonderful experiment, having done it, more than once, in the presence of a young man, my then pupil, who was a witness, and assisted me in all my experiments, and who will corroborate all that I shall here advance. It was in the month of May, in the year 1828, that I rendered a stock of bees insensible (so that, for half an hour, I could do what I wished with them) with the puff-ball recommended by Keys, and took from the hive two pieces of comb, filled with the brood of the working bee only, in all its stages, from the egg to the young bee just ready to come forth. These pieces, with a third containing honey and bee-bread, I fixed in a small box with glass sides capable of holding about a quart; the brood combs being fixed outside next the glass, and the honey-comb in the middle. I then put about half a pint of working bees, only, into the box, and conveyed it to a distant garden for a few days, till the bees had forgotten their old hive. I visited them daily, and then brought them back to my own apiary. The bees had, in the mean while, begun to make a queen, by enlarging a cell till it hung down from the surface of the comb; and, at the usual time, they closed it up. I continued to watch them, I may say, almost hourly;

and at the end of a fortnight the queen came forth. The bees always did cluster thick over the cell where the queen was, to keep it warm, or, as Huber justly remarks, to hatch it: but I could at any time see what was going on, by tapping the box, which made the bees run about, and leave the royal cell clear for a time. The day after the queen was born, I fumigated the bees, and took her out to show my family. I have also seen the queen bee strike silence on the common bee by making a peculiar noise. I have also had the queen frequently in my hand, but never felt her attempt to sting. My method of keeping bees was after Mr. White's plan, as mentioned in the *Encyclopædia Britannica*. I sincerely regret that circumstances obliged me to give up the keeping of bees, as it was my intention to repeat all Huber's experiments. I am, Sir, yours, &c. — *Stephen Watts. Loughborough Road, North Brixton, July 3. 1832.*

ART. V. *Queries and Answers.*

TRAFFICKING in Gardener's Situations. — Sir, I hope you will excuse my encroaching upon your valuable pages with the present complaint; but I am desirous to know whether it is generally understood among gentlemen, horticultural architects, and gardeners, that the situations (in the capacity of gardener) of the former are to be purchased by the latter from the second party, when the gentleman has intrusted him with the charge of procuring him a servant in that capacity. I am sorry to say that the practice is becoming common in Yorkshire, an architect there having lately sold some situations to the best bidder; and, for one place that he now has to procure a gardener for, he is asking the sum of 20*l.*, having had 10*l.* bid, but that was refused. I hope gentlemen will look into this affair, and not allow themselves to be imposed upon in this manner, to the great detriment of their gardens and gardeners. But some of your readers will perhaps throw a little more light on the subject than I can do. I am, Sir, yours, &c. — *An Enemy to Bribery.*

The particulars of this case are given to us by our correspondent in a private letter. The architect alluded to is a Mr. B., of Y.; and the situation is that of C. S., of B., near South Cave. We are surprised that any man professing himself an architect, and, of course, having pretensions to education, and the character of a gentleman, should take such obvious means of bringing himself into contempt as a man. — *Cond.*

Uses of the Red Spider. (Vol. VII. p. 218.) — Has not Mr. Godsall, in his plea for the red spider, on the ground of its usefulness, confounded two very distinct insects? A "beautiful insect, of a rich crimson velvet appearance," is frequent in gardens, especially in spring, and is, I believe, the *Trombidium holosericeum* of entomologists; but this is quadruple the size of, and otherwise very distinct from, "the red spider" so prevalent on hot-house plants, and so troublesome to gardeners. — *J. D. October, 1831.*

The Wire-worm, E'later segetis. (Vol. VI. p. 500.) — I ask whether you are quite sure that the beetle figured comes from the chrysalis, fig. 93. c. If you have actually bred the insect, and reared up the E'later from the chrysalis, I have nothing more to say, and must submit; but if you have not, I cannot believe, and must remain of opinion that the chrysalis in question would produce a very different insect. — *W. T. Bree. Sept. 1830.*

We certainly did not rear it; the drawing was sent to us by a correspondent, who, when he sees this, will probably give some further explanation. — *Cond.*

Preparation of Tobacco. — What is the best mode of preparing tobacco grown in England? What is the best mode for gardeners to adopt respecting it? Is there not a liquid sometimes used in the preparation after fermenting? And are we not under some restrictions in growing

it? — *A. N.* March 3. 1832. [Answers, in part, to some of *A. N.*'s queries, will be found at p. 42. of the current volume. — *Cond.*]

Sterility of hybrid Plants. — On the 19th of May, M. Dutrochet addressed a letter to the Academy, in which he attributed the sterility of hybrid plants to the imperfection of their sexual organs. In the flowers of some hybrid cherry trees (derived from the union of the *Prunus Cerasus* and the *Prunus àvium*) the stamina have no pollen; and their anthers form a compact mass, which does not divide into pollenic or fertile dust, as is the case with fruitful cherry trees. (*Jour. R. Inst.*, Aug. 1831.)

Agency of Electricity in promoting the Rooting of Cuttings, and the other Processes of Vegetation. — In reply to the query of *J. R.* (Vol. VII. p. 379.), I would remark, that, in my opinion, it is undoubted that electricity promotes the development of plants; and I consider it certain that, if gardeners were to electrify their cuttings, they would find them grow much more easily than at present. One of our countrymen (the fact is registered, I think, in the interesting tracts of the Cavalier Amoretti) sowed turnips in two pots: when just through the ground, he electrified the plants in one pot, but not those in the other; in the course of fifteen days they were further electrified; and the effect was, that in three weeks, or thereabouts, the electrified plants were 4 in. higher than the others. Further, in an orchard were placed electrical conductors of iron among the branches of a fruit tree: the tree produced, in proportion, a much larger crop of fruit than the other trees in the neighbourhood. According to the experiments tried by Signor Brunodi Sazzi, a branch of *Gleditschia triacanthos*, 2 ft. long, furnished with a single thorn, attracted as much electricity as a brass point; from which it may be inferred, that the rapid growth of this plant is owing, in a great measure, to the electricity which it has the power of absorbing from the atmosphere. It is known that by electricity water is decomposed; and that its component parts, oxygen and hydrogen gas, are both highly nutritive to plants; also, that electricity increases the action of oxygen, and that it stimulates the irritability of living beings. The experiments of Sir Humphry Davy, who put grain to germinate in water absolutely charged from a voltaic battery, is well known. It is thus clear that electricity must act on cuttings in a very useful manner.

A Query in Electricity. — Having thus answered *J. R.*, let some one answer a question for me. It is known that a mixture of two parts of oxygen gas, and of one of hydrogen, (the initial temperature being communicated to it,) will inflame, and develop sufficient caloric to burn the diamond. It is also known, that, by means of a voltaic battery to each pole of which is united a thread of platina, the electric fluid, being forced to enter a glass tube full of water, produces a development of gas in both the ends of the tube; that connected with the negative pole being hydrogen gas, and double in quantity to that produced by the positive pole, which is oxygen. Now, my query is, may not an apparatus similar to that of the voltaic pile, or some other mechanism, be found, which, acting on a mass of water, may decompose it; and may not the oxygen and hydrogen gas, thus disengaged, be collected in immense receivers; some (those for the hydrogen gas) double the size of the others (for the oxygen gas); thus procuring for any one, economically and at will, in any part of the earth, volumes of combustible materials and (comburent) eminently calorific? — *Luigi Manetti. Monza, Feb. 26. 1832.*

Fountain Wells. — The facility in many, and the certainty in all, cases, with which fountain wells may be obtained, promises very great advantages. Besides the water of the clouds, rivers, and lakes, it is had from two other sources; viz. land springs and main spring. The first are liable to fail when most wanted; the second never. Land springs are often found upon, and always at no great distance below, the surface of the ground. They are collections from exhalations ever rising from the interior of the

earth, and from snow, rain, and other condensations of water from the atmosphere. On these last resources, land springs depend for their existence and supply. What is not quickly carried away by rivers, brooks, and drains, sinks into the earth; but, being intercepted in its downward course, by horizontally placed strata of rock or clay, reposes thereon, and from there gradually oozes away at the lowest point of the impervious bed which prevented its sinking perpendicularly. Any shaft or opening sunk into this bed readily admits a flow into it from the saturated soil around, which is then easily obtainable by the pump or bucket. Water, so procured, always partakes more or less of the predominating qualities of the soil through which it percolates. Hence the different mineral springs; and hence the various degrees of brackishness, commonly called hardness, of domestic wells.

Main springs are sometimes seen gushing out from the sides, but much more frequently from the bases of high hills. Sometimes they are reached by the common well-digger; but, in general they are located at a depth far beyond his reach by any ordinary means. The water of main springs is known by its high temperature; this being always more or less, according to the depth from which they flow: those nearest the surface are about 42° Fahr., increasing to 56° or more. They are also known by their quality; being, in almost all cases, freer from impregnation of salts, and are consequently called soft water.

Whether the main springs are supplied from the same sources as the land springs, and that they are less impregnated with salts or other qualities, in consequence of their receiving greater filtration in their passage to the depths at which they are found, is a question deserving consideration. But that they do possess the qualities of high temperature and purity is undeniable, and with these qualities water is invaluable. For the kitchen, sideboard, dairy, and still-room, how necessary; in the bath and dressing-room, how convenient; in the brew-house, how suitable; and, in the laundry, how profitable! To the gardener it is a useful auxiliary, and to the dyer, &c., most important. In short, the art of forming fountain wells, by which may be gained a constant supply of soft water, without labour or expensive machinery, presents extensive benefits, which are not yet even apprehended. At present, we are still ignorant how high such fountains may be carried above the surface of the earth; and how copious such jets may prove. The ascent of water from such considerable depths is, in itself, a mystery. When the auger is passed down into a subterranean current or reservoir in a valley, and the water flows up, it is accounted for by saying that the outlet is below the principal source. But when such perforations are made on the highest ground, and where there appears no inclination or fall of surface to the spot, it is difficult to account rationally for such a phenomenon. The natural law for water finding its own level does not, apparently, apply. Is it the pressure of the atmosphere? the subsidence of the superposed earth? Is it from the expansive power of subterranean heat, or from the temperature of water itself? or what? — *M. Chelsea, Jan. 1829.*

Lilium Mártagon. — This plant never produces petals with me, though three or four other species of *Lilium*, growing in the same soil (a strong loam) and situation, do. The stamens and anthers are large, fleshy, and green; and, instead of petals, I can see nothing but very minute green scales. Is this a common case, and is it to be cured? If so, how? — *John Trotter. Fulham, June, 1832.*

What are the best Means of preventing the Dry Rot in Oak Timber? — It appears from the newspapers that government has advertised for 10,000 loads of oak timber for ship-building, and that some gentleman (I believe, at Portsmouth) has written an essay to prove that the government ought always to stipulate for its being winter-felled, although they would in that

case sacrifice the bark, and thus be compelled to give as much more for the timber as would cover the price of the bark to the seller. The advantage he anticipates from this stipulation is, that it would put a stop to dry rot, which now makes such ravages in ship timber, and is the cause of such enormous expense in the king's dockyards. In consequence of the dry rot, instead of a ship's lasting forty or fifty years without needing much repair, it scarcely lasts more than four or five. I am afraid that the cost of the bark would prove so serious an addition to the expense, that it would deter government from adopting the advice offered. I know little or nothing of dry rot; it is perhaps presumptuous in me to say any thing on the subject; but as great wisacres seem somewhat puzzled to account for it, and still more at a loss to find a remedy, I may perhaps be excused if I offer a few suggestions on the subject, though they may be (like many which have been already offered) perfectly useless. The general opinion seems to be, that the dry rot is owing to a fermentation which is produced in the timber by the sap which it contains in consequence of being felled at an improper time of the year; and the desideratum is, how shall we get the bark for the tanner's use, and at the same time preserve the wood in a state fit for naval purposes?

It appears, from the experiments of Darwin, Mr. Knight, and several others, that the sap flows from the root through the sap-vessels in the alburnum into the leaves, where it is elaborated; and then, descending again between the bark and the wood of the previous year, it deposits another layer of new wood, which the year afterwards serves as a channel for the ascent of the sap. It is the practice of the peelers in this neighbourhood to lop off all the branches of the trees, that they may bark them more conveniently, as they peel boughs of less than 2 in. in diameter; and it appears to me that if, instead of this plan, they were to allow them all to stay on, and peel as far as they could go, without much endangering their safety, say until they came to where the branches are 4 or 5 in. in diameter, the value of the bark they would lose would be comparatively small, both from its lightness, and the extra-labour required to procure it. All the leaves of the tree being left on at the same time, the sap would rise through the alburnum, and be elaborated by the leaves: but as there would be no bark for it to descend by, it would be retained by the branches above where they kept on their bark. I am no physiologist, and therefore my theory may be as absurd and injurious in practice as another theory I have had on the same subject. I had once an idea, that if the sap-wood were sawed through all round the tree, early in the spring, this operation would effectually prevent the rising of the sap, and the tree would be fit to fell any time of the year. On mentioning, however, my plan to an intelligent friend of mine, he assured me that it was the very worst that could be adopted, as it was exactly what was done by the backwoodsmen of Canada and the United States, who, when the trees are just coming into leaf, saw through the sap, and decomposition takes place so rapidly, that in a very few weeks the branches drop off, and shortly after the tree falls to the ground quite rotten. Perhaps some correspondent versed in vegetable physiology will do me and others the favour to elucidate those points of the subject, which the vague notions I have expressed involve. I am, Sir, yours, &c. — *T. G. Clitheroe, Lancashire.*

American Sugar obtained from the Sap of Maple. — Sir, I send you a cake of American sugar, made from the sugar maple; it is what the settlers use. Why cannot we grow the tree, and make the like. Is the tree to be obtained from the English nurseries? — *B. Coventry, June 25. 1832.*

We have tasted the sugar, and think it, as far as we can judge, in no respect inferior to that sold in the shops as brown or moist sugar. Whether it is ever likely to become worth growing in this country, we are more than doubtful; but we shall give what information we can on the subject, for the use of those who may be disposed to try.

“ The American sugar maple will grow to the height of 40 ft. It has some resemblance to the Norway maple when the plants are young. The flowers are yellow, disposed in short compound corymbs, composed of imperfect hermaphrodite and perfect male flowers, the anthers being abortive in the first, and perfect in the last. From this tree the inhabitants of North America make a very good sort of sugar in large quantities. It is very probable that the Americans make sugar from many species of maple, particularly *A. rubrum* and *Negundo fraxinifolium*. The juice is obtained by tapping the trees in spring: warm days and frosty nights are most favourable to the plentiful discharge of the sap. A hole is made in the tree, in an ascending direction, with an auger, and a spout is introduced about half an inch, which projects from 3 to 12 in.; it is generally of sumach or elder. The sap will sometimes flow six weeks, according to the temperature of the weather. Troughs are placed under the spouts, to receive the sap, which is carried every day to a large receiver, from which it is conveyed, after being strained, to the boiler. Lime, eggs, or new milk, is added to the sap, in order to clarify it; but clear sugar may be made without any of these ingredients. The sugar, after being sufficiently boiled, is grained, clayed, and refined, in the same manner as the cane sugar in the West Indies. The sooner the sap is boiled the better. It should never be kept more than twenty-four hours. The quality of maple sugar is superior to that which is made in the West Indies from the cane, and it deposits less sediment when dissolved in water. It has more the appearance of sugarcandy. . . . The sugar prepared from the sap of this tree is one of the greatest conveniences to the inhabitants of the western countries, is equal to any other sugar, and procured with little trouble.” (*Pursh, as quoted by George Don, in his Miller's Dictionary, p. 650.*)

Of these three kinds of maple, we believe that *Acer saccharinum* can be obtained from Messrs. Loddiges, and *Acer rubrum* and *Negundo fraxinifolium* (*Acer Negundo* L.) can be procured from any nursery where shrubby trees are cultivated. — *Cond.*

The Spruce Fir does not seem to thrive in England. What can be the reason? You never see it growing well in a clump. The case is different on the Continent: the whole of the Hartz Mountains in Germany are covered with it, and it affords both fuel and timber for the mines and furnaces of that district. It is planted or sown, and cut down, in masses, like our coppice woods; and self-sown seedlings supply the vacancies created by every cutting. In some other parts of Germany, in Bavaria, and part of Prussia, lines of the spruce fir are used very extensively as hedges, producing at once shelter and abundance of very durable timber. In like manner, both in France and Germany, hedges, or rather lines of trees, serving as boundary fences, and at the same time as sources of shelter and shade, are used in the same way as thorn hedges are in England. They produce an enormous quantity of timber for fencing and fuel every twenty or thirty years; and, every year, the fall of their leaves supplies manure. They require no expense in weeding after planting, or in training, pruning, or clipping, as thorn hedges do; but remain untouched from the day they are planted till the day they are cut down. They are 10 ft. high or upwards when planted, and are put in about 1 ft. apart. — *A Traveller. London, June 5. 1832.*

Polygala with variously coloured Flowers.— This plant is as common in some places (for example, on Killiny Hill, near Dublin), as the self, or uncoloured, variety. Numberless analogous instances will occur to every person at all conversant with plants. To assist Mr. Bree in investigating some of the phytological arcana of nature, I would take the liberty respectfully to recommend to him the perusal of *Causal Botany*, by my friend, Mr. David Bishop, Curator of the Belfast Botanic Garden. — *E. Murphy. Dublin, Feb. 7. 1832.*

ART. VI. Covent Garden Market.

<i>The Cabbage Tribe.</i>		From	To			From	To
		£ s. d.	£ s. d.			£ s. d.	£ s. d.
Cabbages, White, per dozen		0 0 6	0 1 0	Rosemary, per doz. bunches		0 4 0	0 0 0
Cauliflowers, per dozen		0 2 0	0 3 0	Lavender, per dozen bunch		0 4 0	0 0 0
<i>Legumes.</i>				Tansy, per dozen bunches		0 1 6	0 0 0
Peas	per sieve	0 1 6	0 3 0	<i>Stalks and Fruits for Tarts,</i>			
	per sack	0 3 6	0 10 0	<i>Pickling, &c.</i>			
Windsor Beans, per dozen		0 4 0	0 6 0	Vegetable Marrow, per doz.		0 2 0	0 3 0
Kidneybeans, per $\frac{1}{2}$ sieve		0 2 6	0 7 0	<i>Edible Fungi and Fuci.</i>			
<i>Tubers and Roots.</i>				Mushrooms, per pottle		0 1 3	0 1 3
Potatoes, New	per ton	4 0 0	8 0 0	Morels, dry, per pound		0 12 0	0 0 0
	per cwt.	0 4 0	0 8 0	Truffles, English, per pound		0 12 0	0 0 0
	per bush.	0 2 0	0 4 0	<i>Fruits.</i>			
Cornish Kidneys, per bush.		0 10 0	1 10 0	Apples, Dessert, per $\frac{1}{2}$ sieve		0 3 6	0 5 0
New, per pound		0 0 1	0 0 2	Hawthornden		0 2 0	0 3 0
Carrots:				Juneating		0 0 0	0 3 0
Young, per bunch		0 0 6	0 0 8	Sack and Sugar		1 1 0	1 10 0
Horn, per bunch		0 0 8	0 1 0	Nectarines, per dozen		0 1 6	0 2 0
Red Beet, per dozen		0 1 0	0 0 0	Apricots, per dozen		0 7 0	0 0 0
Horseradish, per bundle		0 3 6	0 5 0	Almonds, per peck		0 1 6	0 2 0
Radishes, White Turnip, per bunch		0 0 1	0 0 0	Plums, Dessert, per punnet		0 0 3	0 0 6
<i>The Spinach Tribe.</i>				Cherries, per pound		0 4 0	0 6 0
Sorrel, per half sieve		0 0 6	0 0 9	Circassian, per pound			
<i>The Onion Tribe.</i>				Currants, per $\frac{1}{2}$ sieve:			
Onions, Green (Ciboules), per bunch		0 0 4	0 0 6	Black		0 3 6	0 4 0
Leeks, per dozen bunches		0 3 0	0 0 0	White		0 3 6	0 5 0
Garlic, per pound		0 0 8	0 0 0	Red, for wine		0 3 0	0 5 6
Shallots, per pound		0 0 6	0 1 0	for tarts		0 2 6	0 3 0
<i>Asparaginous Plants, Salads, &c.</i>				for dessert		0 5 0	0 7 0
Asparagus, per hundred		0 1 6	0 3 0	Raspberries, Red, per gallon (2 pottles)		0 0 6	0 0 8
Artichokes, per dozen		0 3 0	0 5 0	Strawberries, per gallon (2 pottles) about 3 pints		0 0 3	0 1 0
Lettuce, Cos, per score		0 0 6	0 3 6	Myatt's New Pine-apple, per gallon		0 1 6	0 3 0
Celery, per bundle (12 to 15)		0 2 0	0 0 0	Pickling Walnuts, per bush.		0 8 0	0 0 0
Small Salads, per punnet		0 0 2	0 0 0	Pine-apples, per pound		0 4 0	0 10 0
Watercress, per dozen small bunches		0 0 6	0 0 0	Hot-house Grapes, per lb.		0 3 6	0 8 0
Burnet, per bunch		0 0 1	0 0 0	Melons, each		0 2 6	0 7 0
<i>Pol and Sweet Herbs.</i>				Cucumbers:			
Parsley, per half sieve		0 1 6	0 2 0	Frame, per brace		0 0 6	0 1 0
Tarragon, per dozen bunches		0 5 0	0 0 0	Pickling, per hundred		0 2 0	0 0 0
Fennel, per dozen bunches		0 2 0	0 0 0	per dozen		0 0 8	0 1 0
Thyme, per dozen bunches		0 3 0	0 0 0	Oranges	per dozen	0 1 0	0 3 0
Sage, per dozen bunches		0 2 0	0 0 0	per hundred		0 10 0	1 4 0
Mint, per dozen bunches		0 1 6	0 0 0	Lemons	per dozen	0 1 0	0 2 0
Peppermint, per doz. bun.		0 2 6	0 0 0	per hundred		0 8 0	0 14 0
Marjoram, per dozen bunch.		0 3 6	0 0 0	Sweet Almonds, per pound		0 2 3	0 3 0
Savory, per dozen bunches		0 2 0	0 0 0	Nuts, per peck:			
Basil, per dozen bunches		0 4 0	0 0 0	Spanish		0 4 0	0 0 0
				Barcelona		0 6 0	0 0 0
				Brazil Nuts, per bushel		0 14 0	0 16 0

Observations. — Up to the present (since the last report), the supplies have been good and regular, but ten days or a fortnight later than last year. Prices have been moderate, and are at present very low, in consequence of the limited demand occasioned by the prevailing alarm that fruits and vegetables are conducive to derangement of the stomach, and, consequently, likely to lead to the present prevailing illness. The mischief arising from this impression is very serious, and should be fearlessly met, and refuted if possible. Strawberries have been very abundant, and in the early part of the season the growers obtained good prices for them; but the later sorts or varieties have not at all repaid the expenses of bringing them to market. While on this subject, I must introduce to your notice three new varieties of the season:— 1. Myatt's New Pine-apple Strawberry, possessing every requisite quality; size, colour, flavour, firm and fleshy, a prolific bearer, succeeding the seedlings, and carrying, with the old pine, the period of this delicious fruit full ten days longer in the season. 2. Knevett's New Seedling Pine, also a firm fine-flavoured fruit, and a good bearer. 3. Faulkner's New Seedling Pine, a large-fruited variety, erect in stalk, and of excellent flavour; very closely resembling the old Carolina. Raspberries, a good crop, and of excellent quality. Gooseberries, most

abundant, large, and fine. Currants, a fair crop, and excellent. Cherries have not been so abundant as expected; but the supply has been quite equal to the demand: in consequence of the prevailing dry weather, they have come to market in excellent condition. Apples are reported to be a partial crop, the earlier sorts being rather plentiful. Pears are generally an excellent crop in all the varieties. Plums are partial in crop, but, no doubt, as plentiful as may be required. Peaches and nectarines have been furnished in tolerable abundance, and excellent in size and flavour; with pine-apples, grapes, and melons: of the latter, we have already had several importations from Holland. Vegetables have been plentifully supplied, and, as usual, of excellent quality; except lettuces, which have been much injured in their early growth by the prevalence of cold nights. — *G. C. Covent Garden, July 19. 1832.*

ART. VII. *London Horticultural Society and Garden.*

JUNE 5. 1832. — *Exhibited.* Magnolias, yellow Chinese rose, and sweet-scented Chinese rose, from the Rev. Thomas Garnier. Yellow Banksian rose, sweet-scented Scotch rose, *Caprifolium flavum*, and *Magnolia obovata*, from Mr. Robert Donald, nurseryman, Woking. *Rhododendron Smithii*, from Messrs. Loddiges. *Calceolarias*, from Mr. J. D. Parks. Hybrid cactus, and hybrid *calceolaria*, from Mr. Henry Groom. Hybrid *calceolarias*, from the Rev. W. H. Roberts. *Azalea indica* white-flowered, and *Cotoneaster microphylla*, from W. Wells, Esq. *Combrètum comosum*, and two kinds of *Schizanthus*, raised from Mr. Cuming's Chilean seeds, from the Comte de Vandes. A species of *Alstrœmèria*, sent from America by Dr. Nuttall, from C. Barclay, Esq. A species, with its fruit, of *Tacsônia*, from Chile, from Mrs. Marryatt. *Fuchsia bacillaris*, and *Cercus Jenkinsonii*, from Mr. W. Dennis, Chelsea. [This lovely *Fuchsia bacillaris*, wand-branched fuchsia, is really a very charming species. Many will consider it more beautiful just before its blossoms are expanded than after they are expanded, as, previously to expansion, they form so many pendulous crimson globes; in expression of which characteristic, some, it appears, have applied to this species the epithet *globosa*, which, although very expressive, must, according to the laws of botanists, give place to that of *bacillaris*, as by this latter specific name the species has been published, with a figure of it, in the *Botanical Register*, t. 1480. The above plant, as exhibited by Mr. Dennis, well exemplified his extraordinary powers of cultivation. The plant exhibited occupied a pot of about the size No. 8, was a yard in height, its longest branches so spread as to form a circle 2 ft. or more in diameter, and the upper ones becoming successively shorter, so as to render the plant conical in figure; all the branches were bearing flowers; and the plant had been, by Mr. Dennis's skill and attention, rendered in this state in the short space of a few weeks, from that of a starved but healthy plant, growing, or rather living, in a sixty-sized pot, and being scarcely more than a foot in height, and almost destitute of a single branch. Besides thus altering the condition of this individual plant, which I saw in both states, Mr. Dennis has also struck numerous cuttings from it. — *J. D.*]

Also, from the Garden of the Society. Flowers: *Azaleas*, *rhododendrons*, *Scotch roses*, *Rosa Banksiæ lutea* and *alba*, *Bignonia capreolata*, *Cratægus oxyacantha rosea superba* [This is the most exquisite variety described in our last (p. 362.) under the denomination of "A new variety of hawthorn, with carmine crimson blossoms. — *J. D.*], *C. heterophylla*, *Wistaria Consequana*, *Tellima grandiflora*, *Collinsia grandiflora*; *Pentstemon procærus*, *Scouleri*; *Lupinus polyphyllus*, *polyphyllus albus*, and *nootkatensis*; *Mimulus moschatus*, *Quisqualis indica*; *Æsculus flava*, *humilis*, *Pavia*, *Pavia parviflora*, *neglecta*, and *rubicunda*; *Gloxinia caulêscens*.

Exhibition of Azaleas and Rhododendrons. The Council of the Society having announced that a large silver medal and Banksian medals would be awarded for the best exhibition of azaleas and rhododendrons at the Meeting of this day, collections were received from the following persons: — The Rev. Thomas Garnier, Messrs. Waterer, Mr. James Thompson, Messrs. Chandler and Sons, The Earl of Caernarvon, Mr. Robert Donald, Messrs. Loddiges, Mr. John Lee, Messrs. Rollisson, William Wells, Esq., and Mrs. Marryatt. The large silver medal was adjudged to Mr. Waterer; the first Banksian medal to Mr. Lee; the second Banksian medal to the Rev. Mr. Garnier; and a third Banksian medal was recommended to be given to Mr. James Thompson for his rhododendrons; and a fourth to William Wells, Esq., for his azaleas.

Distributed. Seeds from the Garden of the Brussels sprout to the Fellows of the Society.

June 19. — *Read.* A paper entitled Theory on Rockworks in Botanic Gardens (First Part); by the late Franz de Paula, Chevalier de Schrank.

Exhibited. Ranunculuses, Spanish irises, anemones, from Mr. Henry Groom. *Sarracenia purpurea*, from Mrs. Marryatt. Seedling *Pæonia albiflora* and seedling *Pæonia Richardsoni*, from Mr. Chandler. Thirty-two hybrid calceolarias, *Pelargonium Barclayanum* and a seedling, *Calceolaria Hopeana*, *Erica ventricosa superba*, two cauliflowers 6 lbs. 11 oz. and 5 lbs. 13 oz., from Sir Edmund Antrobus, Bart. *Kalmia latifolia* new var., seedling Scotch roses, from the Rev. F. Beadon. Azaleas, from the Earl of Caernarvon. *Calceolaria Fothergilli* and corymbosa, from Miss Martineau. *Calceolaria* species from Chile, *Péctis* species from Chile, and *Brassia maculata*, from the Comte de Vandes. *Magnolia Thompsoniana* and glauca, *Spartium virgatum*, azaleas, and rhododendrons, from Mr. James Thompson. *Erythrina laurifolia*, *Cereus Jenkinsoni*, a seedling cactus, *Gloxinia caulescens*, *Spigelia* sp. nova, hybrid calceolaria, and *Georgina Zelinda*, from Mr. W. Dennis. *Cattleya* species, *Pæonia* var. from *P. edulis* Whitley, from Messrs. Rollisson of Tooting.

Also, from the Garden of the Society. Flowers: *Bignonia capreolata*, *Wistaria frutescens*, *Calampelis scabra*, *Jasminum revolutum*, *Philadelphus hirsutus*; *Robinia macrophylla*, hispida 2 varieties of; Chinese roses, rose de Lisle, Drummond's thornless rose; Scotch roses, double; *Lupinus arboreus*, ornatus, and polyphyllus; *Pæonia albiflora* Whitley; Azaleas; *Calceolaria arachnoidea*; *Pentstemon speciosus*, pubescens, glandulosus, and ovatus; *Brodiaea grandiflora*, *Eschscholtzia californica*, *Mimulus moschatos*, *Iris Xiphium*, *Iris xiphioides*, *Malva purpurata*, *Clarkia pulchella*, *Collinsia grandiflora*, and *Iris lusitánica*.

July 3. — *Exhibited.* Pine-apple strawberries, from Mr. Myatt, Manor Farm, Deptford. Hybrid seedling cactuses, from W. Wells, Esq. Fruit-gatherers of a new construction, from Mr. John Dobson, 13. Newington Causeway. *Sempervivum* sp. from the Cape, from John Reeves, Esq. *Magnolia Thompsoniana*, from Mr. R. Donald. *Oncidium flexuosum*, from the Countess Amberst. Hybrid *Gladioli*, from Wm. Wells, Esq. Hybrid calceolarias, from Messrs. Young of Epsom. *Stuartia Malachodendron*, Yellow Chile strawberry, and *Andromeda cassiniifolia*, from the Rev. J. Beadon. Black Hamburgh grapes, Black Frontignac grapes, White Constantia grapes, Old pine strawberries, and Wilmot's superb strawberries, from Mr. G. Leslie, gardener to G. Fleming, Esq. *Wistaria frutescens*, and *Sophora velutina*, from Messrs. Whitley. A collection of Pinks, from Mr. T. Hogg of Paddington. *Rhododendron maximum*, *Magnolia glauca*, *M. Thompsoniana*, and late azaleas, from Mr. Thompson of Mile End. *Habenaria fimbriata*, from Messrs. Chandler. The Council having announced that a large silver medal, and Banksian medals, would be awarded for the best exhibitions of roses at the Meeting of this day, collections were received from Messrs. Wells, Lee, Donald, Burr, Wood, Young, Beadon, Smith, Thompson, Malcolm, and Mrs. Marryatt, Miss Martineau, and

Lord Grenville. The large silver medal was adjudged to Mr. John Lee; and Banksian medals to Lord Grenville and Mr. James Young. A Banksian medal was also recommended to be bestowed on Mr. Wm. Smith, gardener to the Earl of Liverpool, for his yellow Noisette rose.

From the Garden of the Society. Flowers: *Berberis aristata*, *Sutherlandia frutescens*, *Pæonia albiflora fragrans*, *Brodiaea congesta*, and the following Roses:—Drummond's thornless, Rose Clare, Perpétua Lindlèyi, Champneyana, Indica sanguinea, Seven sisters, Celestial China, Indica cernua, Countess of Leven, Perthshire, Ayrshire, Moschata nivalensis, Double velvet, Ornament de Parc, Pluto, Pourpre de Tyre, Feu amoureux, Prince, Flos ex flore, New mottled, Rose du roi, Blush monthly, Rose Sophia, Blond de Angleterre, Violette brillante, Grandesse royale, Manteau rouge, Majestouse, Hollyhock, Grandesse royale, Carmine officinal, Grand pivoine, Holländica major (fl. pl.), Pivoine, Rose bifera var., Old damask, A'lba carnea, Duchesse d'Angoulême, Spineless virgin, Red Belgic, Centifolia nova de Nancy, A'lba unica lûrida flavescens, Carnea, Coronation, Aimable rouge, Damascena rosa nova, Fraser's Noisette, Boursault, Watts's climbing China, Hybrid de la rose de Bengale, Hybrid de Bengale à fl. carnée, Bizarre de la Chine (fl. rouge), Rose de Lisle, Octavie Coerelle, Baron Fabert, Parny, Belle de Vernier, Agathe singulière, Gabrielle d'Estrées, Graciense, Duchesse de Montebello, Mordaunt de Launay, Délicatesse bizarre, Oberkampf, Mademoiselle de Bordeaux, Belle Hélène, Charles Auguste, Daphne, Hybride d'Ecosse, Belle Thérèse, Rien ne me surpasse, Hybride du Luxembourg, Rose Cramoisie grand feu, Proserpine, Constance, Félicité, Enchanteresse, Double burnet, Prince de Galles, Bifera grandiflora, Eliza Descemet, Rose carteen, Georgienne de Lafay, Belle Auguste, Belle Henriette, Ducis, Aréthuse, Grand cramoisie, Ninon de l'Enclos, Rouge admirable, Nouvelle favorite, Brown's superb, Mademoiselle Mars, White de Méaux, Ranoncule rouge, Grand Henriette, Rose Nannette, Beau regard, Cordon bleu, Fanny Bias, La Baronne de Staël, Cumberland, Poniatowski, Duc d'Orléans, Rose vandail, Stéphanie, Belle Fabert, Miaulis, Rose pirole, Umbellata, Lodoiska, Lucille Debours, Rouge de paradise, Andromaque, Caroline Michel, Palmyra, Davoust, and Italian evergreen. — Fruit: Early purple griotte cherry.

July 17. — *Read.* A paper on the cultivation of the Camellia, by John Allnutt, Esq. A paper on the Black Corinth grape, by Mr. Robt. Thompson.

Exhibited. Bigarreau cherries, Black Tartarian cherries, and Red masculine apricots, from Henry Pownall, Esq. Grosse mignonne peaches, Royal George peaches, and Black Hamburg grapes, from Mr. J. W. Thompson. A Cucumber, from Mr. T. Allen. *Fuchsia globosa*, from Mr. Bunney of Kingsland. Hybrid *Calceolaria*, from John Wells, Esq. Marigolds, from George Bangley, Esq.; and a model of an Orange-box, from John Allnutt, Esq.

Professor Lindley's Lectures. — In continuation of these, we give the notes taken of the second and third lectures; and shall give those of the remaining three in our next Number. In the meantime, as Mr. Lindley has published the essence of these lectures in a two-shilling tract, entitled *Outlines of the First Principles of Horticulture, &c.*, we strongly recommend that work to our readers, and more especially to every young gardener. There can be no doubt of this, that even the very best practical gardeners might be rendered still better, by receiving a fresh infusion of science, to neutralise the prejudices engendered by a long course of empirical practice. There is no man in Britain so able to effect this object as Mr. Lindley; and we sincerely hope he may persevere in this new line which he has chalked out for himself, confident that success and great public good will be the result.

LECTURE II. *Principle of Adhesion; Cuticle; Axis of the Seed; Stem; Nodes and Internodes; Axils of Leaves; Scales; Buds formed on Leaves;*

Endogenous and Exogenous Trees. — After briefly recapitulating the heads of his former lecture, Mr. Lindley observed that the principle of adhesion may be termed the hinge of vegetable structure, since, perhaps, no other science exhibits in a more striking manner its effects. Besides its regular operations, this principle often produces monstrosities; two gourds, two apples, or two peaches, growing close together, become united from pressing constantly against each other. The flowers of the cockscomb owe their singular shape to this principle, as, in cases where it has been prevented from acting, they have been found to spread out into branches. A similar monstrosity has been observed in the common asparagus; and in several other plants.

Every plant is covered, except at the extreme points of its roots and the upper surface of its stigma, with a membrane or cuticle, which, though so extremely thin and fine as to be generally invisible to the naked eye, is yet composed of parts adhering so firmly to each other as to admit of its being peeled off. When viewed through a powerful microscope, this membrane is found to consist of cellular tissue studded with stomata; and to appear streaked with a number of parallel lines, formed of rectangular or irregular network.

Every seed contains within itself a vital point, or axis, consisting of two cones, which, in the process of germination, elongate themselves in opposite directions; one producing the stem, and the other the root. These two parts being essential to all plants, Mr. Lindley proposed to consider them separately.

All stems, whether of herbaceous plants or timber trees, are subject to the same general laws, and are all provided with leaf buds, by which only varieties can be propagated. Buds are sometimes considered in the nature of seeds, as they also possess a vital point from which both a stem and a root will proceed; but there is this essential difference between them, that from the one is raised a new plant of the parent tree, and from the other a distinct individual. Leaf buds spring from nodes, or knots, of which there are always several on every branch, at regular intervals. Sometimes these nodes are placed exactly opposite to each other, and at others at various distances, but always on alternate sides of the stem. Whenever two leaves are found together on the same side, without one occurring on the opposite side, it may be safely concluded that the missing leaf has been removed by some accidental circumstance. The spaces between the nodes are called internodes, and these intervals are of irregular length; generally, however, becoming shorter towards the extremity of the branch. Buds are sometimes found on the internodes, but, when they are, the circumstance must be considered as a kind of *lusus naturæ*, and not as a general law.

Each leaf forms with the stem an axil, in which is found an axillary bud. Buds are covered with scales, generally dry and brown, which drop off as the leaves unfold themselves. There is sometimes a second, and even a third and fourth, set of scales, of various tinges of white, brown, and red, found enveloping the incipient leaves. All, however, no sooner expand, than they drop off.

Buds are sometimes found upon leaves. The fragments of a leaf of a species of *Ornithogalum*, laid upon moist ground, produced buds, not only on the edge of the leaf, but on its surface; and a few plants produce buds on their leaves naturally. Among these may be mentioned the *Malaxis paludosa*, and the *Bryophyllum calycinum*.

Plants are divided into two classes, with regard to the internal structure of the stem: viz., the endogenous, or such as increase inwardly; and the exogenous, or such as increase outwardly. The former do not enlarge their bark, or outer circumference, after a certain point, but gradually fill up their interior by successive depositions of fibrous matter, which, in the

centre, is so loose, that it may be pulled out in strings; but which, near the outer bark, becomes by compression a dense substance, nearly as hard as ebony. As the centre fills up, this dense substance gradually increases; till, at last, it will admit of no farther addition, and the whole trunk is changed into an almost impenetrable mass. After this period the tree begins to decay; and, consequently, endogenous trees rarely attain any great age. Nearly all the timber trees of this class are natives of tropical climates.

Exogenous plants are those which increase by concentric layers, deposited between the inner bark and the alburnum, or outer surface of the soft wood. The substance enclosed by the bark being thus enlarged, the outer bark frequently cracks, and flies off in flakes, its place being supplied by a new bark formed beneath it. The diameter of exogenous trees thus increases every year; and as, under favourable circumstances, this process may continue an indefinite length of time, no certain period can be fixed for their decay. When creepers twine round the trunk of an exogenous tree, they are frequently found, in the course of a few years, buried in the bark, and they thus often destroy the tree which supports them, by preventing the proper circulation of the sap. This, of course, is not the case with endogenous trees, which are never injured by the tropical climbers, though these frequently attain the thickness of a man's wrist, and are sometimes found with their folds growing together, from the principle of adhesion, so as to form a complete shell.

The centre of exogenous trees is called the heartwood, and is, in consequence of the solidification of its vessels, unfitted for the circulation of sap, like the other parts of the tree. It is always the first to decay; and instances are often seen, where the trunk of a tree is completely hollow, and yet the branches thrive, and bear leaves, flowers, and fruit.

It is generally supposed that the age of exogenous trees may be counted by the number of concentric layers which they contain; but this rule Mr. Lindley declared to have many exceptions. Sometimes two zones form in one year, and sometimes, from the situation of the trees, or other accidental circumstances, the zones are nearer together on one side than on the other. Thus, calculations made by comparing the diameter of the tree with the distance between the two outer zones, and thus endeavouring to estimate the number of zones in the interior, have been often found erroneous: and there is little doubt but that the enormous age attributed to some trees, especially the baobab and the deciduous cypress, may be explained in this manner.

Mr. Lindley concluded by saying that want of time obliged him to postpone the consideration of roots till his next lecture.

LECTURE III. *On the Roots of Plants, and on the Formation of Timber.* — In the present lecture, the professor observed, he should commence with that portion of his former lecture which he had been obliged to postpone for want of time, viz., some description of the structure and functions of the root. The distinction between roots and stems appeared at first sight so obvious as scarcely to need definition; and yet it was difficult to distinguish, by mere external appearance, between detached portions of the two. A piece of old root, sawed in two, and polished, strongly resembled a piece of stem timber; and a detached root of the screw pine might easily be taken for the trunk of some kind of cane. Potatoes and other tubers were also often called roots, when they were, in fact, as he should explain hereafter, only portions of buried stems. It was necessary, therefore, for the botanist, or rather the physiological horticulturist, to look beyond mere external appearances for the true difference between roots and stems. These might be found in the position, structure, growth, colour, mode of extension, power of propagation, and functions of the root, all of which were essentially different from those of the stem.

The Position. With regard to this, Mr. Lindley observed that he had already stated the fact, that both the root and stem of a bud or seed proceeded from one common centre; which elongated itself at the same time in opposite directions, the upper shoot producing the stem, and the lower one the root. This was when the seed or bud was placed in its natural position: if, however, it were reversed, and the part destined to produce the stem were placed downwards, the tendency of the stem would still be to ascend, and of the root to descend, in spite of the obstacles opposed to this natural inclination. There is an extraordinary power possessed by plants of accommodating themselves to circumstances; and this power was shown strongly in the case in question: the fibrils of the root might be compelled by heat and moisture to germinate, and, finding no opening in their natural direction, might be forced to expand upwards, but it was only unwillingly and by mere compulsion; and they would always be found trying to overcome the difficulties opposed to their resuming their original position. Many curious experiments have been tried with a view of ascertaining this fact, particularly by Du Hamel and several French physiologists. One of these experiments consisted in placing a bean, with the root uppermost, in a bottle of water; of which the bean exactly covered the whole bottom, leaving no room below it. The root germinated, and, being unable to insinuate itself between the bean and the glass, proceeded upwards, but in a spiral manner, and making various efforts to find an opening by which it could descend. Another experiment was, sowing buck wheat on a surface of quicksilver; and then, by means of heat and water, forcing it to germinate: when the roots, being unable to penetrate the quicksilver, ran along its surface, sometimes assuming a hooked appearance, and, when near the edge of the pot, extending themselves over it, and running down its sides. A third experiment was, filling a flower-pot with fine, rich, moist earth; and, having placed a seed close to the bottom, suspending it in the air: the seed would soon begin to germinate, but the root, instead of expanding itself in the nourishing soil prepared for its reception, would turn over, and contrive, if possible, to force its way out of the hole at the bottom of the pot into the open air, where, of course, it must soon perish for want of moisture. It is a vulgar error to suppose that the roots of a tree always extend as far as its branches. That they do extend a considerable distance from the centre is certain; and it is a wise provision of nature that they do so; as otherwise, from the dense foliage of some trees keeping the rain from wetting the ground for a considerable circle round their trunks, the roots, and consequently the tree, would soon perish for want of moisture.

The Structure of roots is essentially different from that of stems. Those portions nearest the trunk of timber trees are, in fact, only elongated portions of the stem, stretching into the ground for the purpose of giving stability to the trees. The roots necessary to vegetation are slender threads called radicles, or fibrils, composed of fibrous tissue, embedded in cellular substance; the centre of the fibres being abundantly provided with ducts, for the purpose of conveying the moisture extracted from the ground to the plant. At the extremity of these fibrils is a portion of spongy mucus, composed entirely of cellular tissue, and easily distinguishable to the eye by its yellow tinge, as the professor demonstrated by exhibiting the roots thrown out by the eye of a vine kept in water. The points of the fibrils, as far as they are composed of mucus, are called the spongioles; and it is found, that, if they become dry, and lose their spongy qualities, the tree must perish. They are, in fact, the mouths of the plant.

The Growth of roots is different from that of stems. Stems increase by the progressive development of their parts, every bud containing within itself the germ or embryo of the perfect plant: roots, on the contrary, possess no power of self-elongation, but increase by successive depositions

of mucus at their extremities, concentrated by the power of adhesion, and gradually acquiring the consistency of tissue.

The Colour of stems differs from that of roots. Stems, till darkened by exposure to the atmosphere, and other causes, are generally green; but roots, except those of two or three plants, never assume that hue.

The Mode of Extension is also different. Stems throw out their branches from nodes placed at certain intervals, and their position may always be ascertained by some fixed rule: roots are always irregular, their fibrils crossing and recrossing each other in every possible direction, and the intervals between them being referable to no kind of calculation.

The Power of Propagation possessed by stems is altogether deficient in roots properly so called. It is barely possible that a radicle might, under peculiar circumstances, produce an adventitious bud, in the same manner as a leaf has been already shown to possess the power of doing; but, when such cases happen, they must be considered as exceptions from the general rule, and must be regarded as a species of monstrosity.

The Functions of the root, the professor observed, he had already mentioned, and it would be foreign from his purpose to dilate on them at present, as it was his intention to recur to the subject in a future lecture.

After thus enumerating the points of difference between roots and stems, the professor proceeded to speak of the nature of the different kinds of substances called by the general name of roots. He first observed that though roots, properly speaking, are incapable of propagation by division, several substances commonly designated as roots have that property. Most of these substances may be classed under the names of tubers and bulbs. Tubers partake greatly of the nature of stems; and may be considered as prolongations of the stem under ground, containing accumulations of fecula, formed from some unknown causes, as in the potato and the Indian arrow-root; probably intended by nature for the nourishment of the young plant before the fibrils of its root have become sufficiently strong to imbibe food for themselves. In all cases, tubers are furnished with buds or eyes, which each possess a separate vital principle, and are each capable of throwing out roots and a stem; in short, of producing a perfect plant. The tubers of the arrow-root are oblong, and are attached to the base of the stem by a slender ligament, which, as they advance towards maturity, decays. The powder called Indian arrow-root is made from the fecula contained in these tubers. Elongations of the stem of other plants, partially thickened, often bury themselves in the earth, forming buds, and throwing out stems and roots, so as to form new plants, as in the case of the couch grass.

Bulbs are, properly speaking, buds; each containing in itself the embryo of a new plant, and having roots proceeding from its base. Bulbs consist of a number of laminae or scales, each scale being either the rudiment or the residuum of a leaf. As new leaf-buds are formed in the axils of leaves, so new bulbs or cloves (as in a root of garlic) are formed in the axils of scales; and though not always developed, they exist in an inert state, and are always capable of being called into action. Destroying the stem, and affording an excess of nourishment to the parent bulb, would assist in calling this dormant power forth; and it has been said that this method is sometimes employed in Holland, for propagating new or rare species of hyacinth. The propagation of a valuable species of *Zamia*, under peculiarly adverse circumstances, affords a striking proof of the practical use of a knowledge of the physiology of bulbs. The *Zamia* is a plant with a large bulbous stem, distinctly marked with dry hard scales, the bases of decayed leaves, and crowned at the apex with a circle of large fern-like leaves, without any other stem than the bulb from which they spring. A valuable plant of this genus was sent to the botanic garden at St. Petersburg; but, from want of care, or other incidental causes, it was found, when it arrived,

to be completely rotten at the core. Many persons, seeing it in this state, would have thrown it away as useless; but Dr. Fischer, who has the direction of the garden, being well acquainted with the laws of vegetable physiology, was determined to try to force the hard outer covering of the *Zamia* to develop its incipient buds. He had the core carefully scooped out, every particle that was in a state of decomposition being removed, and then filled the cavity with fine rich soil. The bulb was afterwards placed in a moist warm atmosphere; and he had soon the satisfaction of finding the theory above detailed beautifully illustrated, by the germination of a great number of young plants.

The manner of the formation of timber (though a subject of such importance in a national point of view) is yet involved in considerable difficulties. Many hypotheses have been started, and supported by different physiologists, but no one has yet been found to which all able men are willing to agree. Professor Lindley owned that he had formed his own opinion on the subject, but, as other opinions were still supported by very scientific botanists, he deemed it his duty to state the principal conflicting hypotheses as clearly and as impartially as he could. He said he had shown in a previous lecture that all trees are either endogenous or exogenous; that is, that they increase either internally or externally. The timber trees of England, and of most temperate climates, belong to the latter class; and they increase by concentric layers, formed, one every year, between the inner bark and the alburnum, or surface of the young wood. The manner in which this layer is deposited is the point respecting which botanists do not agree. Of the various opinions that have been broached on this subject, Mr. Lindley said, he should only state two, which he considered the principal: viz. 1. That the increase in diameter of timber trees is effected by the annual transformation of the inner bark into alburnum; the former alburnum hardening into wood, and a new inner bark being formed by the exuding juices of the tree: and, 2. That fibres are being constantly sent down by the leaves, which imbedding themselves in the cellular tissue, formed by the descending sap, make a new layer between the inner bark and the alburnum.

Various experiments have been tried by the supporters of the first of these opinions; one of which seemed almost conclusive. A portion of the outer bark having been removed, and a thin plate of silver having been bound on the outside of the inner bark, this plate of silver was, in a few years, found buried in the tree. On the other hand, the advocates of the second hypothesis, viz., that the layer of new wood is formed by depositions from the leaves, assert, that, if a tree be ringed to such a depth as to cut off the communication between the alburnum and the leaves, the stem below that ring will not increase in size, but that the part above the division will exhibit an extraordinary swell, as though the nourishment intended for the whole trunk were concentrated to that point. In further support of the same hypothesis, it had been observed that trees planted on the edge of a wood, in such a situation as to have only one side exposed to the full benefit of the sun and air, and which, of course, have partially developed their leaves and branches, are found invariably to have their concentric layers of wood broader on the vigorous than on the stunted side. After stating these opinions, Mr. Lindley observed that many objections had been raised to the second of them, because its first supporters had asserted that each individual leaf, or rather bud, sent down fibres through the whole body of the tree directly to the ground. This appeared to be carrying the doctrine rather too far.

THE
GARDENER'S MAGAZINE,
OCTOBER, 1832.

ORIGINAL COMMUNICATIONS.

ART. I. *General Results of a Gardening Tour, during July, August, and part of September, in the Year 1831, from Dumfries, by Kirkcudbright, Ayr, and Greenock, to Paisley.* By the CONDUCTOR.

(Continued from p. 391.)

IN this fragment of our tour, we shall introduce a few words on the agriculture of the west of Scotland; and take next in order field hedges, plantations, edgings of walks, lawns, kitchen-gardens, and the construction of hot-houses. In a succeeding fragment, which will appear in our Number for December, we shall criticise the palace, mansion, villa, and cottage residences, of this part of our route, and thus conclude our tour.

In the Agriculture of the West of Scotland, the cultivation of turnips in rows has been carried to a very high degree of perfection; insomuch, that thirty tons per statute acre of Swedish turnips are usually calculated on, when the soil and weather are tolerably favourable. Carrots and mangold wurtzel produce generally within one or two tons of the same quantity, and common turnips and potatoes from two to five tons more. One principal cause of this enormous produce is unquestionably the moisture of the climate; but, at the same time, much is owing to the culture, which is very perfect. The rotation, on most soils, is, 1st, turnips, potatoes, or other herbage or root, crop drilled, the dung being buried in the drill, or naked fallow; 2d, barley or wheat, with

clover and rye-grass; 3d, clover and rye-grass fed off, or the first crop mown for hay; 4th, pasture; 5th, pasture; and, 6th, oats. Round Kilmarnock, a great quantity of annual and perennial rye-grass seed is raised, and this crop is reckoned on a par with one of oats, in point of exhausting the soil. Iron ploughs have almost every where been substituted for wooden ones, and the saving is considered great, on account of their extreme durability. They were introduced about twenty-six years ago, and there is not a single instance of one of them being worn out. Finlayson's harrow, invented in the neighbourhood of Ayr, by a farmer of that name, a most ingenious and excellent man, who, unfortunately, did not live to see the effects, and reap the fruits, of his invention, is also very generally used; and we have been informed by several farmers, and particularly by our esteemed friend, Mr. Tenant of Shields, that, in consequence of employing this implement, they never plough their turnip, potato, or other fallows more than twice; viz., in preparing the ground, to break up the stubble; and, before sowing or planting, to form the drills. In naked fallows, the plough is only used at first breaking up, and in turning in the manure before sowing. Stall-feeding is general, both for fattening cattle and for milch cows; but the latter are always turned out to pasture a portion of every day. Under-draining with tiles, in what is called the Essex mode (that is, putting drains in every furrow, or in parallel lines from 12 to 20 ft. apart, in order to carry off the water from soils having retentive sub-strata), has been introduced, and most extensively employed, by the Duke of Portland, on his large estate, reaching from the sea-shore, at his harbour of Troon, to and beyond Kilmarnock. The same principle of draining has been practised by Mr. Buchanan at Catrine: but the drains there, instead of being laid with tiles, are filled with small stones within a foot of the surface; in our opinion, a much more effective and more durable mode. Mr. Buchanan has also turf-drained moss, or peat bog. The covering turf, or surface spit of the bog, is dried in the sun during one summer, previously to using it, till it has become charred, and insoluble in water; and this turf being broader than the bottom of the drain (*Ency. of Agr.*, 2d edit. fig. 651. p. 709.), is rammed into it, so as to form an arch. These drains are cheap, require no carting on the moss, are effectual for the end in view, and are found to last for a long time.

The Field and Roadside Hedges, in most places in the west of Scotland, particularly in Ayrshire, are exceedingly well managed, being trained so as to form a body of verdure from

3 to 4 ft. broad at the base, from 5 to 7 ft. high, and from 6 in. to one foot wide at the top. When pruned, they are always cut upwards with a knife or bill, and are never clipped or cut downwards. The estate of Mr. Oswald, at Auchincruive, is, in this respect, as in most others, a perfect model for landed proprietors. In Dumfriesshire and the stewartry of Kirkcudbright, the hedges by the roadsides are frequently planted in dwarf walls, which are backed up with earth (as the caper plant is about Marseilles and Toulon), so as to spring up from the face of them, and form hedges over their tops; a practice suitable for districts abounding in stones, because it saves all expense of cleaning the hedge when young, and insures a close-bottomed fence.

The Plantations, which have so much improved the general features of the west of Scotland, have three defects, more or less conspicuous. These are, too great a sameness in the mixture of trees, a want of variety of character in the outline of the masses, and a general neglect of thinning. The mixture consists almost every where of larch, firs, common pine, and round-headed trees: whereas, in low situations, with the exception of spruce firs, and some sorts of poplar and willow, round-headed trees only, or chiefly, should have been planted; and spiry-topped trees only, or chiefly, in very elevated situations. At all events, this may be considered as a sort of general rule, suitable for those who cannot apply a principle. We are quite aware that a great deal may be said in defence of the present practice: it may be alleged that the larches and pines are merely intended as nurses; that all of them will ultimately be removed; and that, whether the situation be high or low, no trees can be more beautiful. We shall not stop to enter into the details of both sides of these and similar arguments, but observe that the birch, the alder, the willow, and the poplar will be found of as rapid growth, and the latter, at least, fully as profitable, in many situation, as the larch and the pine. The spruce fir, also, in cold, low, and wet lands, forms one of the most rapid-growing and profitable of trees. In all situations, neither very high nor very low, trees may be safely and profitably planted in masses, almost entirely of the same sort, without any nurses. With a knowledge of these facts, and some taste for general effect, a variety in the aspect of the plantations, on any one estate, may be easily produced, without any loss of profit, in bulk or value of timber, being sustained. Every considerate gardener will allow this; and we remind gardeners of it, much less in the way of finding fault, than as affording hints for their future guidance.

The direction of the boundary lines of plantations made on the sides of hills is of great importance, in respect to the effect of these plantations when seen from below. There is a character of greatness as well as of littleness, even in lines, though it would be difficult, in a few words, to describe in what that character consists. Lines which express grandeur are always simple; graceful lines are always varied. In order to produce a harmonious whole, the lines of a plantation should, in general, bear some relation to the lines formed by the surface of the ground on which it is placed. We say in general; because there may be surfaces, the natural lines of which it may be desirable to counteract by those of plantations; for example, the outlines of lumpish forms of surface, or dead flats. Straight lines, or lines gently curved, are more suitable for a flat country, than for the sides of hills; an undulating country should obviously have more undulating lines than straight lines; and a rough abrupt country more angular lines than curvilinear ones. Every one must feel that on the undulating sides of a hill, curved lines are more in concord than straight lines; and that varied curves are more graceful than unvaried ones. In some of the most extensive plantations on the hills and mountains of Cumberland and Westmoreland, as well as on those of Dumfriesshire and Kirkeudbrightshire, an artist's eye will detect deviations from the above principle, which the planter of taste should mark, in order to avoid. However, we are too well satisfied to see plantations carried on extensively in any way in these districts, to be very fastidious about the details; and, therefore, having made the foregoing remarks, more with a view to the future than to the past, we shall pass on to our third defect, neglect of thinning and fencing.

Whether a man prepares the soil properly previously to planting, encloses sufficiently, and prunes and thins adequately afterwards, is of much less consequence to the public than it is to himself. A plantation may be admirably adapted to the situation in which it is placed; may be planted with the proper sorts of trees; and may, in its young state at least, be every thing that can be wished in regard to the improvement of the landscape, and yet afford little or no profit to the proprietor. With the profit, indeed, the public may be said to have very little to do: all that they are fairly entitled to criticise is the general effect; and for that, and for that alone, neglected plantations are (all other circumstances being equal) for the first fifteen or twenty years of their growth, as good as well-managed ones. So much ground has been planted in the west of Scotland within the last thirty years, that there is not the least danger of a scarcity of

native timber; there is equally little danger of a deficiency of surface for the culture of grass or corn; and therefore, if any landed proprietor chooses to ornament the country without benefiting himself, the country, so far from objecting, ought to be very much obliged to him. We can assert, without fear of contradiction, that there is not one proprietor in a hundred, in the west of Scotland, that prunes, thins, and otherwise manages his plantations as he ought to do, in order to make the most of them in point of profit during the first twenty years of their growth, and of both profit and beauty afterwards.* This fact, when considered in the abstract, seems almost incredible; nevertheless, it cannot be denied, though in many cases it would seem difficult to assign a reason. An opinion that plantations cannot afford profit for many years after planting; ignorance of what is required; indifference on the subject; and a general dislike to cutting down trees, whether young or old, are reasons which very generally prevail. The last is carried to an extent which may be considered a diseased feeling; and is, in our opinion, most ridiculous. In Ayrshire, we found very extensive plantations, of from five to thirty years' growth, on one nobleman's estate, from which not a tree has been thinned since they were planted at the rate of five thousand plants to the acre. The mass has become impervious to either man or cattle; and, as timber or fuel, it would not, if now cut down, as the very intelligent gardener on the estate informed us, pay the cost of the trees, nearly four times the price, thirty years ago, that they are now, before they were removed from the nursery. On another nobleman's estate, in the same country, we found oaks in more than double the above number per acre, which, we were informed, it was never intended to thin, but to leave to grow up together, and choke and kill one another, in imitation of nature. We have no objection to this plan, provided it be not recommended as good, with a view to profit. A plantation composed of trees all planted or sown at the same time, can never be said to be a just imitation of a state of nature. In natural woods we find trees of all ages; and hence, the ease with which the stronger overcome the weaker, and acquire a timber size; but where all are sown or planted at once, and at equal distances, all are

* We say profit and beauty afterwards; because, after trees have attained a timber height, much of their beauty, when collected in masses, depends on each tree having room sufficient to show the character of its head. Hence a wood, consisting of trees singly and in small groups, with underwood beneath, is almost always more beautiful than a grove consisting of trees only; because, in the latter case, the trees generally, even in the best-managed groves, stand too thick.

generally contending for what none can attain without the assistance of art, and the whole grow up together in a mass of etiolated rods, with only here and there a tree to be found which has attained a timber-like size. The only case in which this result does not take place, in an extreme degree, is when different genera of trees have been planted in mixture: in which case those of the most vigorous habits and rapid growth will overcome the others.

As contrasts to the plantations on the two estates mentioned, we may refer to those of Monkwood, near Ayr, in which the trees (each judiciously pruned so as to form a handsome stem, more or less clothed from the ground upwards) stand at proper distances; and the thinnings, as Mr. Smith of the Monkwood Nursery informed us, have more than paid a corn rent, reckoning from the time the plantation was made. We may also refer to one or two others in Dumfries and Kirkcudbright shires, and especially to those at Closeburn and Ter-ragles, as being profitably managed; though, in the latter case, and as, indeed, in most others that we saw, the trees are too closely pruned.

The publication of Sir Henry Steuart's *Planter's Guide* has given a considerable stimulus to the transplanting of large trees; viz., trees of from fifteen to thirty years' growth, and from 20 to 40 ft. high. We could not help noticing the practice of some proprietors, who, while they neglected their young plantations, or managed them improperly, could yet afford to expend time and money in transplanting large trees; which is about in as good taste and judgment, as if a man were to commence ornamenting the walls of his house before he had roofed it in. We have seen some parks in Dumfries and Kirkcudbright shires, and we could mention one in Ayrshire, recently sprinkled over with trees, in imitation of Sir Henry Steuart's manner, in superlatively bad taste. We recollect only one instance in which an attempt was made to group the trees, and to add shrubs to them; but the individuals composing these groups were placed too far apart, and the effect, in consequence, was in a great measure lost.

Edgings of Walks. — The faults which we have been obliged to find with the edgings of walks, in former articles (Vol. VII. p. 404. 546.), are less frequent in that part of Scotland which we passed through, than they are in England; partly, we believe, from there being less labour to spare for the walks; but partly also from gardeners being fully aware that the harsh edgings, which we complain of, are deformities. Hoeing and raking, which among growing crops may certainly be considered beauties, because they are presumptive evidences of good culture; we found by some gardeners considered beau-

tiful when applied to gravel walks ; but on this subject we need only refer to what we have said before. (Vol. VII. p. 544.)

Grass Lawns.— We observed very few lawns in Scotland that were mown often enough to produce a very fine velvet turf; a circumstance easily accounted for, from the absence of the proprietors, and the slender means left to keep their seats in order. More or less of lawn with smooth turf, and of walks covered with a fine, compact, and bright-coloured gravel, are, with us, essential to the luxury of every country house. When the recently invented mowing machine, which we are happy to find is coming generally into use throughout England (p. 34.), becomes general in Scotland, we may, however, hope that lawns will be kept as we could wish them. The gravel in the west of Scotland is generally rough, loose, and very unpleasant to walk on. In some places rotten rock is used as a substitute for gravel, which makes, when powerfully rolled, a very agreeable surface to walk on, though not one very pleasant to the eye. Where no gravel abounds naturally, there is always in Scotland a very good substitute to be found in finely broken stone; for example, in granite, basalt, sandstone, or some variety of bright coloured-schistus; and this broken stone, when firmly rolled, forms an elegant and durable as well as agreeable walk. The use of a heavy roller for compression, and of salt or handweeding for destroying the weeds, instead of loosening the surface by the hoe, as well as of dried clay in powder to mix with and bind river gravel, seemed to us to be generally wanting. Indeed, the use of a roller, which will give five or six times the pressure which by any possibility can come on a walk or road, is not even generally understood by engineers in England. Our attention was first directed to it by a friend (Mr. Tomalin), who is of opinion, that by the use of very heavy rollers, after making or mending roads, they might every where be rendered as smooth as gravel walks, and as durable as pavement. Burnt clay which contains iron often assumes a beautiful reddish yellow colour, and might form a very good substitute for Kensington gravel.

The Kitchen-gardens in Scotland are generally formed at greater expense, and kept afterwards with more care and neatness, than they are in England. The reason may be, that the climate requires a greater variety of fruits to be cultivated against walls; and that the kitchen-garden, being usually well sheltered, and also ornamented with flowers, is, contrary to the English practice, as much used as a place to walk in, by the female part of the family, as the pleasure-ground. We found some Scotch kitchen-gardens kept with remarkable

neatness, and without a single weed ; the defective part being the gravel walks, which, as before observed, being hoed and raked, are generally loose, and disagreeable to walk upon. As may be supposed, from the number of hands being almost every where diminished, we recognised a falling off in the keeping of kitchen-gardens since the time we were last in this part of Scotland ; but what struck us as the greatest defect in almost all the Scottish gardens, as well as in most of the English ones which we have seen during our tour, was the barrenness of the wall fruit trees. We do not recollect a single garden in Scotland, where there was a fair crop over every part of the walls, unless it were at Kilkerran. The cause is clearly owing to the practice of digging and cropping the borders. Most gardeners are as well aware of this as we are ; but they say they cannot do without the crops produced by the borders ; and that, if they were not to crop them, their masters would think they were not doing their duty. What we would say in answer is, that it is very absurd to be at so great an expense in building walls and training trees on them, and at the same time to take the most effectual means to prevent these wall trees from producing fruit. We shall not repeat what we have already advanced (Vol. VII. p. 542.) ; but it may be useful to mention, that, in the excellent new garden at Kilkerran, not a peach or a nectarine was produced, till the very intelligent gardener, Mr. Cullen, took up the trees, formed a substratum of lime rubbish, firmly beaten down, and covered it with soil not deeper than 1 ft., then replanted the trees, and never since cropped or even dug the ground about their roots. Mr. Cullen has now short well-ripened wood, and good crops of fruit every year. In the garden at St. Mary's Isle there is a vinery which never fails bearing an abundant crop ; and here the border has not been dug for thirty years, but only covered with rotten leaves and rotten dung, underneath which Mr. Nisbet showed us a web of fibres rising to the surface, and feeding on it. Planting standard fruit trees in kitchen-gardens is a bad practice, and generally prevalent : the vegetables or small fruits grown below them can never attain a proper size and flavour ; and the culture of the soil, required to produce these vegetables and small fruits, is as injurious to the standard trees as cropping borders is to the wall trees. Dwarfs and espaliers along the walks are less objectionable than standards in the compartments : but how seldom do we find such trees bearing good crops ! The cause is in the digging and cropping. Standard fruit trees are generally best planted in an orchard by themselves ; the ground very slightly cropped, till the trees

have attained a considerable size, and the ground afterwards sown with grass; or, what is preferable, merely kept free of weeds, by hoeing, forking, or slight digging.

The Construction of Hot-houses of every description is by no means so far advanced in the west of Scotland as it is in England, and still less the mode of heating them by hot water. By far too much labour is bestowed on the woodwork, in forming mouldings, panels, and other ornamental surfaces, which serve little purpose but that of harbouring dirt and moisture and vermin, rotting the materials, and darkening the house.

(To be concluded in our next.)

ART. II. *Horticultural Jottanda of a recent Continental Tour.*
By ROBERT MALLET, Jun. Esq.

EVERY young gardener of the present day ought to travel abroad; and if two or three join company, so much the better. There are useful hints as to the *how* a young gardener of small means is to manage this, in the *Encyclopædia of Gardening*; but pecuniary difficulties are not so great as may be imagined. An attentive and careful young man could and ought to have saved 80*l.* by the time he is 24 years of age; and with that sum he may remain three months on the Continent; and in that time have been a week in Paris (long enough to see carefully all that is useful to a gardener there), have seen some of the South of France, the best of the Alps, most of Italy, and returned through Germany, Belgium, and Holland.

From nearly such a tour I have just arrived; and although it was not made with any particular view to horticulture or natural history, I beg to offer a few scattered observations, made at the time, on those subjects; conceiving, that, although not very valuable, they may elicit better from others, or excite a desire to travel in those who have never before felt it.

To premise from my own experience, I think the following hints of equipment may not be unserviceable:—

A traveller on the Continent should be as expeditious as possible: he should have no trunks or portmanteaus at all; as, by these means, he will escape almost all the troublesome examination of the *douaniers*, or customhouse officers, and be enabled to go to places that he never could, if loaded with a huge baggage. Instead of all this, he should have one large carpet bag, much larger than usual; consisting of carpet outside, varnished linen next, and lined with strong ticken or

canvass. The varnished linen is absolutely necessary to protect from rain; linen, clothes, &c., may be tied up in a rectangular piece of grey canvass, prepared with short straps for the purpose, which will preserve them clean and unruffled; a strong dressing-case should include all small articles: a large sponge, for washing, is a great luxury in a southern climate. A person of good general health will find much advantage, in the south of Europe, from taking with him abundance of Seidlitz powders; magnesia, which the acid wines render necessary; and a box of aloetic pills, which will be efficaciously purgative.

For the preservation of specimens of natural history, he should carry a strongly made box of wood, about 12 in. by 8 in., and 4 in. deep, with boards of soft pine to drop in, one on another, leaving spaces, from $1\frac{1}{2}$ in. to half an inch, for sticking insects on, or laying by any small miscellaneous fragile articles. Some loosely bound books of blotting paper, that will fit into a leather writing-case, will answer for a temporary hortus siccus. A stout leathern bag, with plenty of lapping paper, will preserve mineral specimens; none of which, however, on account of their weight, should be collected, but such as are really worth preservation.

Many plants, especially succulent ones, may be brought home alive, by being included in a cylindrical tin canister with small holes in the top, and a piece of soft wet sponge in the bottom, to envelope the roots. I brought home alive, from Florence, specimens of the *Agave lùrida*, *Euphòrbia triangularis*, *Cactus monánthos* [? *Opúntia monacántha*], &c., simply by wrapping their roots in a bit of sponge, wetting it from time to time, and including the whole in brown paper, and that in an old boot.

I would recommend a solitary or pedestrian traveller, in Italy, to carry a strong pair of detonating pistols. A showy military uniform, though singularly inappropriate for a gardener, is probably the best travelling dress.

I shall not attempt a regular tourist's journal; of such too many exist; and I have neither time nor inclination to add to the number. Perhaps of all the guide-books of the Continent published, not one is to be wholly depended on. Good maps are the best guides; the German published ones are the most accurate and full.

Every traveller to Paris, by the way of Havre, should go by the steamer up the Seine, which I think rivals, if it does not exceed, the Rhine in beauty. The banks of the Seine are in most places lofty, in some abrupt, but nowhere flat; always either verdant, or clothed with a golden crop, and wooded

with magnificent poplars, which cast their long reflections in the still deep stream. Its whole course is a succession of beauties: villages are thickly set upon its brink; here an ancient decaying château faces its long straightly planted chase to the water, and, far beyond, some lofty minster raises its airy pinnacles amidst umbrageous woods. The nurseries at Rouen are said to be worth visiting, particularly for their standard roses; an article so artificial, costly, and speedily dying, even in the nursery, that I imagine they will soon cease to engage the attention of our gardeners, especially as, with proper management, engrafted roses may be grown as strong, and, I think, to look as well.

The best mode of management for standard roses I have seen is that of Mr. M'Cabe, gardener to Mr. Lefroy, near Dublin. A long semicircular hedge of sweet and dog briar, partly surrounding a parterre, is cherished into strong upright shoots, a succession of which is constantly maintained; these are budded, and those that die are immediately replaced by budding on the vacant stocks. When in bloom, it is quite a kaleidoscope of roses, of all hues and sizes. But to return: I am sorry to say the French nurserymen are not the most liberal: good carnations they have, therefore good seed; but good seed they will not give to an Englishman, if they know him to be such. I myself got some seed only last year, from Rouen, which professed to be wonders: it produced a fine crop of single clove pinks.

The road between Rouen and Paris is not very remarkable. The hedges are clothed luxuriantly with the *Clématis Viti-célla* and *Bryonia álba*, plants which grow freely on similar calcareous soils in Britain; but many others, unusual in England, grow by the wayside. Flax is not an uncommon crop in Normandy, but the Indian corn is seldom seen, and never in perfection more northerly than sixty miles south of Paris.

Four years ago, the entire road from Rouen to Paris was a *chaussée*, always a bad though a lasting kind of road; now nearly half of it is macadamised, and well too; a welcome symptom of improvement.

How much finer, in some respects, the entrance to Paris, by any of the boulevards, is, than even the finest of the entrances to London! How much finer the long rows of stately elms, and luxuriant robinias, with quiet pathways,

“ A pillar'd shade, with echoing walks between,”

and the houses retired behind them, than our rows of lath and plaster boxes, with little courts before them, just large

enough to hold a few barrowfuls of gravel, and contain two or three fantastic and unmeaning beds of common flowers; every one laid out somehow different from its neighbour; almost all ugly, and, viewed *en masse*, producing no effect whatever of harmony or grandeur.

This taste probably arises from our national churlishness. We are unwilling to yield the smallest private or exclusive right, for the common gratification of ourselves and others. It will probably be said, the damp of our climate is such, that rows of trees would keep the road in bad order and the pathways constantly wet: the noble lines of lofty elms that dignify the quays of Amsterdam and Rotterdam, where there is much traffic, and in a damper climate than ours, are a proof to the contrary.

Why not, at least, make the trial in some of the new streets laying out about London? Even if the trees should have to be cut down, their timber would pay the expense of the experiment.

It is strange the common robinia [*R. Pseud-Acacia L.*] is not as much used in England, as a forest tree, as it is in France. None can be more easily propagated. It could be obtained from the Continent yearly, is abundantly hardy, and singularly beautiful. When arrived at twenty or twenty-five years of age, it flowers freely, even in Ireland.*

It is true, it is brittle while young, but when old enough for the wood to have hardened in the heart of the tree, it will stand the worst storms; and while young it can be supported, as it always is on the Continent.

Jardin des Plantes. — There is nothing particularly new at the *Jardin des Plantes*, and it has been often described, but the discovery by, I think, M. Turpin, of a large quantity of pure oxalate of lime in botryoidal [bunch-of-grapes-shaped] masses, in the centre of an old "*Cereus peruvianus*," which had been many years in the garden.

There is a sad want of verdure and leafiness on all the inside plants in the Continental gardens, arising from the dark houses they are nurtured in, their being indiscriminately put out under a burning sun in summer, and but sparingly and irregularly watered, and fire heat applied the whole winter.

It will be long ere the gardens of the Continent can vie with those of England in horticultural preservative structures, chiefly owing to their inferiority in the manufacture of iron; but I should think a clever English artisan in this branch

* The use of this tree for timber has been sedulously recommended by Mr. Cobbett, under the name of "locust tree," its name in America, where the tree is native. See *Gard. Mag.*, vol. iii. p. 363. — *J. D.*

would get full work in Paris and the departments. There have been considerable additions of Australian plants to the Jardin des Plantes since I visited it, four years ago, but not many of other kinds.

Much might be said of the publicity of such institutions as this in France, and their exclusiveness in England; but much has been said, and the evil is the same: so that I fear it is connected with our national character; and, until that is changed, the exclusiveness will remain.

The last expedition to Algiers has enriched the garden with a large number of lions and tigers, noble specimens.

I was fortunate enough to see the waterworks play at Versailles the day after the commemoration of the "Trois Journées" [three days] of July, 1830.

Unless the gardens at Versailles are filled with an immense crowd, and the waterworks playing, they are the very abode of dreary splendour. Nothing can be conceived more melancholy and monotonous: this, I think, chiefly arises from the great space seen over at once, and the perfectly symmetrical arrangement. In fine, every thing, individually, at Versailles is costly and fine; and, viewed as a national production, is worthy the "grand monarque;" but, with few exceptions, it presents more lavish expense than good taste. Amongst those few exceptions are the orangery, and the back façade of the palacé. There are some orange trees of great size, and of remarkably fine form, in the orangery, said to be above four hundred years old: their trunks are about 9 in. in diameter.

Although the public gardens of Paris so abound in orange trees, the Parisians have but little advantage of their delicious odour when in flower, as all their blossoms are sold annually to the perfumers. The new suspension bridge over the Seine, the "Pont d'Arcole," although not strictly a gardener's concern, is worthy of notice. Instead of the chains passing over two piers, one on each side of the river, and the bridge thus consisting of one catenary and two semi-catenaries, there is one pier built in the centre of the river, and the whole bridge consists only of two semi-catenaries: thus, when this construction is practicable, about one half the cost of the bridge is saved.

In passing through the interior of France, on the road to Geneva, the small and narrow strips of land into which the law of inheritance divides territorial property are very remarkable. Whether this is advantageous or not is, I think, to be questioned. The want of a rural population and of a resident gentry is too obvious: the whole country is, as it were, a waste of agriculture and forest, scarcely any pasture, and almost no country houses. A striking difference between the

scenery of the Continent, and that of Britain, is, the total want of those frequent crystalline brooks, which beautify and fertilise our land, and the want of which will ever prevent Continental scenery from wholly pleasing an English eye. Either there are large rivers, or there is no water at all. As the distance from Normandy increases, the rich and florid Gothic architecture of the ecclesiastical edifices gradually disappears, and gives way to a disagreeable mongrel between it and the marble-faced classical Italian fanes.

I know not if it be merely fancy, but I imagine there is a constant increase of hilliness from the northern coast of France to the foot of the Alps. At Poligny these Alps first rear their fronts against the traveller, and over the tops of Jura the road leads on to Geneva. Perhaps the panorama that in an instant bursts upon the astonished eye, at the commencement of the descent of Jura, is not equalled by any in Europe. At once, as if by the drawing up of the curtain of a theatre, Lake Lemman, blue as the sapphire, with its dark foreground of pines; the whole High Alps, with their stormy summits; Geneva, Lausanne, Vevay; countless villages and villas, in luxuriant vine-clad valleys, appear. The road, as it winds down Jura, has been constructed with admirable skill, showing the view in all points, and never letting it be lost sight of for a moment, although in a thick pine forest.

The Rhone, at Geneva, is some 70 ft. deep, but so exquisitely clear, that a pebble may be seen in the bottom at that depth; but, seen with its surface at a small angle, to the eye it appears of the most beautiful transparent blue: this, some assert, arises from the lake's waters being actually coloured; but the transparency of the waters *en masse* disproves this. The fact is, it arises from the colour of the bottom, which, being of the same substance as the neighbouring side of Jura, a calcareous tufa, is nearly white; and the blue of the sky is thus reflected with such singular beauty. There is a great number of English residents near Geneva, and every thing bears the appearance of wealth and comfort. The climate is delicious, the oppressive heat of the Swiss valleys being attempered by the lake; and the highest cultivation prevails.

On the smooth bosom of the lake, on each side the everlasting Alps, the quiet sail wafts us on our way to Villeneuve, "as with a noiseless wing."

"Lake Lemman woos me with its crystal face,
The mirror where the stars and mountains view
The stillness of their aspect in each trace
Its clear depth yields of their far height and hue."

Martigny shall be our head-quarters in my next.

(*To be continued.*)

ART. III. *Remarks on certain Gardens in the Lake District, and on cultivating a Taste for Gardening among Cottagers generally.*
By JOSHUA MAJOR, Esq., Landscape-Gardener.

Sir,

I WAS glad to observe, in the Gardener's Magazine (Vol. VII. p. 525.), your particular notice of the gardens of Mrs. Starkey, and of the village of Bowness, while on your tour in the Lake district. It may appear superfluous to touch on this subject, after your remarks upon it, but too much cannot be said in favour of examples like that of Mrs. Starkey; and I am tempted to persuade myself that the ladies generally will pardon me, when I appeal to them to suffer a portion of their benevolence to be similarly devoted. Might not many important objects be accomplished, by ladies, in conjunction with their pastors, frequently visiting poor villagers, to ascertain their general wants; to assist them in times of need; to see that the rising families have moral and religious instruction; to provide small libraries of useful books; and, at proper periods, to establish horticultural meetings, either confined to one village, or belonging to two or three collected together, for the exhibition of horticultural produce, and for rewarding the best productions? These meetings to be conducted by the upper gardeners, together with any other suitable persons, who might provide the villagers with plants, seeds, &c., for their gardens. Attention paid to the poor in this way could not fail to produce in their minds a proper respect towards their benefactors; and its success would constitute a triumph of knowledge over ignorance, of virtue over vice, and of happiness over misery. Instead of the cottager indulging himself in sloth and drunkenness, we should see his leisure hours spent in his garden; his pleasure would be in the company of his wife and children; and his anxiety, that they should share with him in all the domestic comforts that could be afforded.

Having been called to the Lake district on professional business, a few weeks after your call at Bowness, I had the pleasure of waiting upon Mrs. Starkey, whom I found in the village streets, with her pruning-knife in her hand, divesting the laurels of their useless leaves and branches, while her gardener was training them against the village walls. Mrs. Starkey kindly left her employment, and showed me over her grounds, which are not extensive, but which reflect much credit both upon their liberal proprietress and on her gardener, for their superior keeping. They exhibited a splendid show of border flowers, green-house plants, and valuable

shrubs and creepers; from any of which, cuttings, offsets, or seeds, were politely offered me. Observing to the innkeeper of Bowness how pretty the Chinese roses, laurels, &c., looked against the street walls, and what a neat village Bowness was; "Yes," he replied, "we are indebted to Mrs. Starkey for that: since her residence here, she has produced a general taste for gardening amongst the villagers."

I should have been glad had you called upon J. A. Beck, Esq., Esthwaite Lodge, more particularly as Mr. Beck is a gentleman of general good taste, and a subscriber to most of your publications; though, as the distance was far from your line of route, a call could not be anticipated. Esthwaite Lodge is a neat Grecian structure, situated on the border of Esthwaite Lake, a pretty water, about two miles long, and one broad in the widest part, at the distance of about five miles from Bowness, and on the opposite side of Windermere, near to Hawkshead, a small market town. The grounds about the house are naturally much varied, and are capable of being made picturesque and pretty. I have given plans for nearly an entire alteration of them. It is intended to introduce as much variety as the compass of the ground will allow; viz., a green-house, a heath-house, aviaries, aquariums, fountains, rockeries, rural and ornamental seats, various pleasure gardens, forcing-houses, vegetable gardens, &c.; and a peach-house, vinery, and green-house are already built. The grounds, in their present state, are furnished with a valuable assortment of shrubs and border flowers. Mr. Beck's principal enjoyments are in his library, and in horticultural pursuits, sketching, and architecture.

That head of Esthwaite Lake which lies near Hawkshead is, to a considerable extent, marshy; forming various-sized sheets of water. In one of these spaces, about forty or fifty yards in diameter, is seen a small floating island, which, as nearly as I was able to judge, from the difficulty of approaching it, is from ten to fifteen yards long and six or eight yards in width; it is furnished with three or four alders from ten to fifteen feet high, and with bushes, grass, and reeds, the roots of which, I should conjecture, are all interwoven. The curiosity to the beholder is to see this group of trees (all in a growing state, and of the largest magnitude of any in the vicinity), at one time on the south side of the pool, at another on the opposite side; and at other times on its voyage to the west, or on its return to the east, as the wind may direct.

I may just observe, that in the marshy grounds in this neighbourhood the common sweet gale and the *Parnassia palustris* abound; and that the common and other ferns

present themselves abundantly, growing upon living trees and bushes. On the road from the ferry of Windermere to Hawkshead, the yew exhibits itself singularly upon the mountains. The mountain ash, the juniper, the common stone crop, and others of the same species, are all natives of the Lake district; and that humble but beautiful plant, *Saxifraga oppositifolia*, is said to inhabit the mountains.

I have lately been employed to lay out the grounds of a clergyman of the name of Hewgill, in Nottinghamshire, who is pursuing similar steps to Mrs. Starkey. He keeps in his garden a stock of the best sorts of apples and other fruit trees, selected from the London nurseries, to distribute among his poor parishioners, as they may be wanted. This, together with friendly attention in numerous instances, appears to have gained him much respect amongst them. Mr. Hewgill says, so comfortable are the working class of his parishioners, that their situations are enviable: the whole of them keep cows, besides being regularly employed. In this neighbourhood, near to Gainsborough, caraway seeds grow naturally in the pastures, and are gathered by children, and sold at one shilling per pound. The churchyard is planted in several parts, amongst the graves, with thriving evergreens, such as cedar of Lebanon, red cedars, arbor-vitæ, ilexes, &c.; and the porch of the church is covered over with the China rose, Greville rose, and the blotched-leaved *Alatérnus*.

I am, dear Sir, yours, &c.

Knowstrop, near Leeds, March 6. 1832. JOSHUA MAJOR.

ART. IV. *On Gardens for the labouring Poor.* By SELIM.

Sir,

OF all the plans recently suggested for improving the condition of the labouring classes, that of supplying them with land at a moderate rent is perhaps the one most likely to accomplish the object in view; though, to insure success, it requires judgment in the application; for, if a labourer has more land than he can cultivate profitably, that is, more than he can manure and cultivate at leisure hours, it will prove a disadvantage to him rather than a benefit; and this disadvantage will increase, the longer he continues to occupy and exhaust the land. In supplying the poor with land, therefore, two things should be specially considered; viz., how much a working man can cultivate without interfering with his ordinary labour; and how much he can manure. As to the

quantity, I am persuaded that a labouring man in full employment cannot cultivate land with any profit to himself, if it obliges him to "lose time," as they term it; and this is the opinion of all the sensible persons among the working classes whom I have spoken with upon the subject. A man, therefore, who is in constant work, should have a less portion of garden ground than one whose time is not fully occupied; and, in most parishes, there are generally many persons of the latter description, who stand most in need of the assistance of a piece of land. In the county of Wilts the labourers may be divided into three classes. In the first place, there are men employed the whole year by one master; such as carters, shepherds, and threshers, or day labourers. Of these, the carters and shepherds have very little spare time, especially in the spring. A large garden would, therefore, be an inconvenience to such men, and moreover unprofitable, inasmuch as they must hire assistance, or else cultivate their ground very imperfectly. Again, there is a class of men employed as thatchers and hedgers, or general workers in wood, who are not always engaged by one master; consequently they have, occasionally, much unemployed time, which would enable them to cultivate more land than the carters and shepherds. And, lastly, there is a class of labourers who generally work by the piece at turnip-hoeing and bean-setting, and other jobs of that kind; these men, from the nature of their employment, must be frequently out of work, and consequently would have leisure to cultivate, and would indeed require, a larger garden than the two former classes. In apportioning land, therefore, to a labourer, the first thing to be considered is, how much leisure time he has over his regular employment; always bearing in mind that regular employment with a master is the most profitable occupation to a working man. The next thing to be considered is, how much can he manure; for the land would very soon become unprofitable to him, if cropped yearly with potatoes for instance, unless it has the assistance of manure. Now, a clever managing person, who is enabled to grow as many potatoes as would assist in feeding a couple of pigs, and who collects carefully all the refuse of his garden, the produce of his sinkhole and ditches, and what he can pick up on the roads, would, with his wood ashes, raise a considerable compost heap in the course of twelve months. The question is, would he raise nearly enough to cover half his land every year? If he did not, he has more land than he can profitably cultivate, and therefore more than he ought to occupy. In judging, then, as to the quantity of land that a

labourer can cultivate with advantage to himself, regard should be had to the leisure time he has, and to the quantity of manure he can collect; for there can be no profit from his land, unless there be a due proportion observed in these particulars. The quantity being thus determined, there is a third thing to be considered, viz., the situation of the land. Here it should be remembered, that the labourer is to cultivate his land at his leisure time, after he has done an honest day's work for the master who employs him. It is important, therefore, that his land be near home; for if it be at a distance, he will waste much time and strength in journeys to and from it; whereas, if it adjoined, or were near, his house, no time would be lost, and, in fact, he would spend many a half hour in his garden, which he would be obliged to waste if the garden were at a distance. Now, where a parish belongs chiefly to one proprietor, it might generally be contrived that the cottage allotments should be contiguous to the houses, and in all cases they might be chosen at a convenient distance. I often cast a longing look upon a little strip of land in the rear of our village, which seems to be placed on purpose for cottage allotments, within a few minutes' walk of the most distant houses; and I frequently wonder why the owner does not let this land to his labourers, instead of some which is a mile from home, for which they pay at the rate of four pounds an acre: indeed, I have known men give to the small farmers of the neighbourhood at the rate of eight pounds an acre, for land still more distant; which proves, I think, that under proper regulations the cottagers might become the most profitable tenants on an estate, and at least that it would answer them to rent land at the same rate as the farmers pay for it, or even a trifle more.

I have been led to offer these few observations on a subject in which I take an interest, because I fear that the plan of cottage allotments may fail in many instances, from being overdone. I believe it will be found, on trial, that no man in constant work can properly cultivate an acre of land at his leisure hours. There are few, I think, who could manage even half an acre, but a great deal must depend upon the character of the man; and, in many cases, a quarter of an acre would be found sufficient. The system followed by your benevolent correspondent H., Wales, p. 376., is one of the best, I think, that can be generally adopted, both for the master and labourer; and, where this is impracticable, I should prefer the plan of letting, to the superior class of labourers, a sufficient quantity of grass land to keep one cow, instead of supplying all with a large allotment of arable. A carter or

shepherd, who has high wages and little leisure time, might easily manage a cow and two or three acres of grass land, though he might not be able to cultivate properly a quarter of an acre of garden ground; and, after all, I may observe that the success of the plan of letting land to labourers, whether grass or arable, will chiefly depend on adapting the grant to the character of the person to be benefited. A cow, for instance, which is a little fortune to a steady industrious family, would be quite useless to the idle and unthrifty. The allotments of land, therefore, and every thing connected with them, should be managed by the resident landlord, or his agent, who may be supposed to be well acquainted with the character and circumstances of the labourers in the parish.

I remain, Sir, yours, &c.

Near Salisbury, July 12. 1832.

SELIM.

ART. V. *On the Means of inspiring a Taste for Gardening among the labouring Classes of Scotland.* By JAMES STUART MENTEATH, Jun., Esq. of Closeburn, Dumfriesshire.

“Between the upper and lower classes in Scotland, cordiality, mutual confidence, and support prevail, to which many other nations are strangers. It behoves the higher classes to endeavour, by protection, by kindness, and by example, to preserve those principles and relations which have been so honourable to Scotland, which form the basis of good education, and without which education is unavailing.”

“And round about he taught sweet flowers to grow.” *Spenser.*

No country abounds more with seminaries for the education of youth than Scotland; and much of the successful enterprise of her inhabitants may be attributed to the education obtained in these seminaries, of which parochial schools may justly be reckoned the principal. But the education, how good soever it may be, acquired at these schools, might be rendered more perfect, by incorporating with them somewhat of a practical nature, to train the hand as well as the mind. Many employments suited to this purpose might be suggested; but scarcely any could be at once more agreeable and beneficial, than instructing the children in the operations of common kitchen-gardening. The proposal of such a new scheme may startle some, who are not aware that nearly every parochial schoolmaster in Scotland already possesses a garden, of a smaller or larger extent, which might be employed for this purpose; the extent of every schoolmaster's garden being fixed by an act of parliament to be a rood, or quarter of an acre, of ground. Others, again, may suppose that the other business

of the school would be interfered with, and interrupted, were a method of school gardening teaching introduced: but it will not be difficult to show the contrary.

To introduce into our Scottish parish schools the teaching of gardening to children, we should require, in the future appointment of all schoolmasters, a knowledge of the culture and uses of all the common culinary vegetables and fruits, together with a slight acquaintance with flowers; and, to assist those masters already appointed, but who may be ignorant of horticulture, the gardener of some landed proprietor in the parish, or, if none in it, the gardener of some neighbouring heritor, might be called in, to supply the want of information in these respects. A knowledge of horticulture might easily be acquired by all young men qualifying themselves to be parochial schoolmasters, in a similar manner; since scarcely a parish in the southern parts of Scotland is without one or more resident landed proprietors. These all possess gardens, and nearly all keep a gardener. None of these proprietors would deny the schoolmaster access to their gardens; where he might learn, under the direction of the gardener, all the practical useful parts of common kitchen-gardening: and, where towns are near, a more extensive acquaintance with the subject might be obtained by frequenting the gardens of intelligent nurserymen, who would, no doubt, do every thing in their power to facilitate so useful a design.

Supposing, then, the schoolmaster possessed of the requisite knowledge of common kitchen-garden cultivation; his garden, being increased to not less than half an acre of ground, should be divided into portions. These divisions should be of such a size as to admit, in each, of a regular rotation of the several vegetable crops to be raised. Over each plot or division of ground a certain number of children, not too numerous, but so arranged that each individual might be able to put his little hand to the work himself, should be placed. Rows of gooseberry, currant, and raspberry bushes might separate the divisions; and a few apple, pear, and cherry trees might have place, as standards, espaliers, and wall trees. On these, the processes of budding and grafting could be exemplified. In order that no interruption should be thrown in the way of the regular business within the school, the cultivation of the schoolmaster's garden by the children should be only carried on in their play hours, and an hour on Saturdays, when all the other business of the school had been got through, or whenever time could be spared.

In order to secure complete success to this new branch of parish school education, it will be necessary to interest all the

parties; the schoolmaster, the children, their parents, and the landed proprietors of the parish.

In the first place, the schoolmaster receiving all the benefit of the largely increased produce of his garden, as improved and cultivated by the children, may be supposed not unwilling to give every attention to instruct his pupils in gardening, were only sufficient ground afforded for the purpose.

Next, to stimulate the children to exertion and industry, there should be several examinations of the garden at stated periods of the year. To these examinations should be invited all in the parish who take an interest in such improvements. Various rewards, of the following kinds, should be distributed among the young cultivators; such as packets of seeds, containing all the useful vegetables, and a few flowers; these packets to be so numerous, that nearly every child should be able to carry home one with him. Besides these papers of seeds, garden tools of different kinds, books connected with gardening and rural subjects, and even small sums of money, might be distributed, as means to encourage the children to diligence and attention.

The parents, likewise, receiving through their children packets of seeds to be sown in their gardens by their little hands, possessing the skill and knowledge of raising them, will warmly cooperate in introducing this system of school gardening into Scotland.

The proprietor even, although not immediately benefited, cannot fail ultimately of deriving advantage from improvements, in the taste for gardening, which the children, acquiring at the parish school, would spread over all the country. That their property would be more safe, and that the people around them would be more independent, deriving more food from their gardens being well cultivated, must be obvious to all; also, that the moral habits of the people would be greatly improved, as there would be no necessity for breaking into gardens, and stealing their produce.

Thus it will be apparent that this scheme of parochial school gardening, interesting the schoolmaster, the children, the parents, and the landed proprietors, will not fail of being generally beneficial to every one.

The youth of the country will, so instructed, grow up with a love of rural affairs; and, instead of throwing away their time and money in low dissipation, both will be devoted in their leisure hours to useful pursuits. Thus Scotland, from being a country famed for its good agriculture, will become equally so for its cottage gardening; and every cottage will have its garden, stored with all the useful potherbs and vege-

tables, for the food of its inmates; with fruit, so desirable to all; and will be ornamented also with a choice small collection of flowers. In addition to which, a love of plants and flowers being universally diffused, every parish may in time have its little garden society, and its meetings for the distribution of prizes for the best vegetables, and fruits, and flowers, among its members.

April 26. 1832.

JAMES STUART MENTEATH.

In England, the Society of Friends, or Quakers, have excellent free schools; one near Wigton, in Cumberland, another near Leeds, a third at Croydon, and a fourth near Bristol. To each of these, I understand, a garden and farm are attached, on which the children work. In Ireland, the place I cannot recollect, a school to teach agriculture on the best principles has, within these few years, been instituted for the labouring people's children. The effects, I hear, are very striking; and plots of turnips, and other symptoms of improved management, are observed near it. In Switzerland, Fellenberg's school, divided into two departments, one for the rich, the other for the labouring people's children, is well known. There, the cultivation of the farm, and the instruction of the children in agriculture, under the care of an intelligent master, combine in spreading much valuable agricultural knowledge throughout that country; and I cannot see why gardening might not, by means of our Scottish parochial schools, be spread in a similar way among all the labouring people of Scotland. — *J. S. M.*

ART. VI. *On the Construction of double-roofed Hot-houses at Vienna.* By M. CHARLES RAUCH, Court-Gardener at Laxenburg.

THE advantage of double lights for plant-houses is well known in those parts of the Continent where the severity of the winter renders some kind of external covering indispensable; and in several places, particularly in Russia, they are much in use. These structures have, however, lately been improved by M. Seidel, nurseryman at Vienna; and a conservatory (*fig. 84.* section), belonging to M. Meyer, has been erected at Penzing, on the following principle: —

The front and side walls are double, or rather hollow; and the space between is filled with warmed air, which is supplied by a furnace or oven, constructed behind the house for that purpose. Thence the heated air is introduced between

84

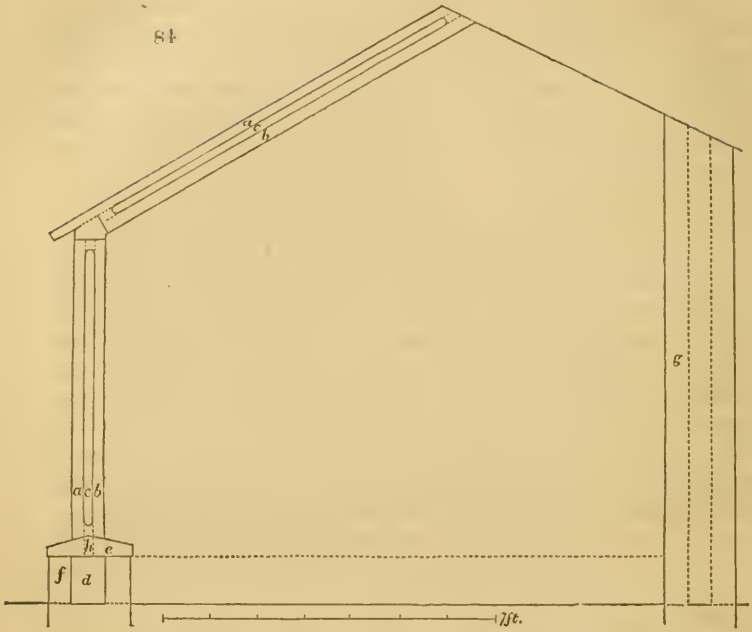

a, Outer sashes. *b*, Inner sashes. *c*, Space between the sashes, cut through the rafters.
d, Space in the wall for warmed air, or hot-water pipes, &c. *e*, Wall plate.
f, Front wall, hollow. *g*, Back wall, also hollow. *h*, Hole through the wall-plate.

the sashes, through perforations in the wall-plate on which they stand; the rafters have also open spaces through their sides, to facilitate the equable diffusion of the warmth, which is thus spread as a covering over the whole house. The advantage which this method of keeping out the cold affords for the cultivation of plants which only require protection in winter, such as ericas, camellias, and New Holland plants, for which the above-mentioned conservatory is designed, is very great.

For stoves, where a higher temperature is required, a flue in the inside of the house would be necessary; and this, if placed in contact with the inner side of the double wall, would be sufficient to heat both the air of the house and that contained between the sashes. It is, however, of no consequence whether the source of heat be hot-water pipes, steam, or fire flues; and, provided the principal object (the warming between the sashes) is attended to, many advantageous variations may be adopted, according to the purpose for which the house is intended; as hot-water pipes between the hollow walls, and flues in the interior of the house, both heated by

the same fire; or the back wall may be flued, and pipes introduced both into the house and between the front and side walls, &c. &c.

Air may be admitted either through ventilators in the walls or in the sashes; and, by forming ventilators alternately in the upper and lower sashes, the coldness of the external air will, in some measure, be taken off, by passing through the warmed stratum contained between the lights. In spring, when a more abundant supply is necessary, the doors may be partially opened, or some of the inner sashes may be entirely removed, and the outer ones opened.

The expense of double glazing, and the consequent loss of light, may be urged as objections to these structures; but when the immense labour of covering every evening with straw mats and shutters, the breakage of glass, and the enormous consumption of fuel, are taken into consideration, the advantage will in a short time be found to be on the side of double sashes. In respect to the light, when the rafters are neatly made, very little will be lost, and the deprivation, at a season when the plants are not in a growing state, is far less injurious than the scorching heat, which, when the house is formed only of single lights, is requisite to resist an intensity of cold sufficient to lower the thermometer 20° , or even 25° , below zero of Reaumur.

Since the above-described house was erected, there has been a double-roofed camellia house built for the Archduke John, near the Carolinen Thor, at Vienna, of which *fig. 85.* is the ground plan.

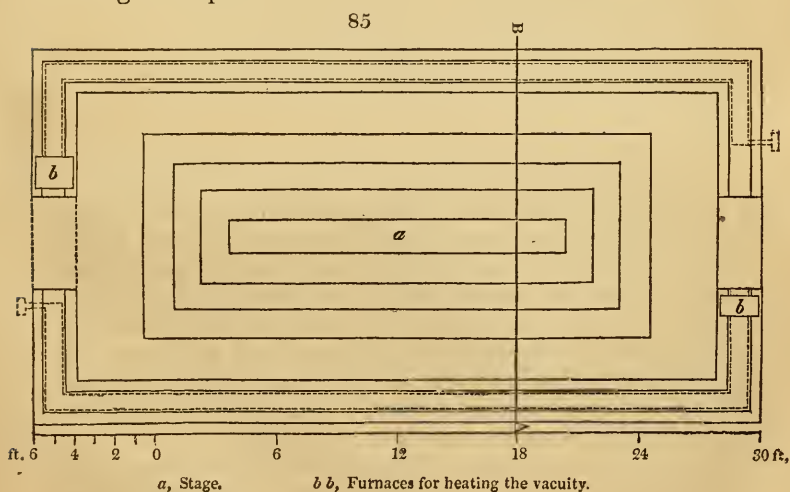
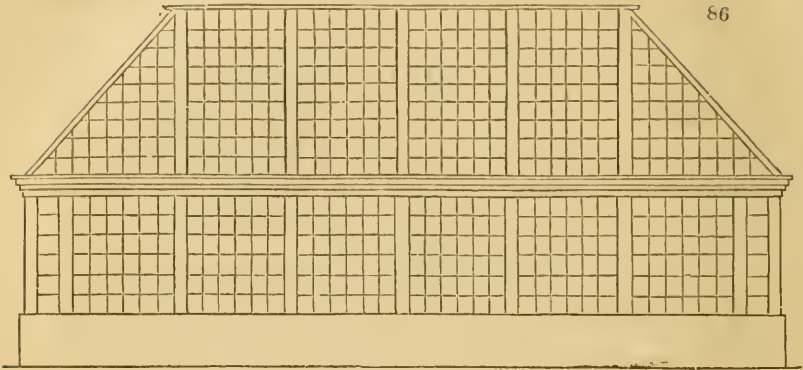
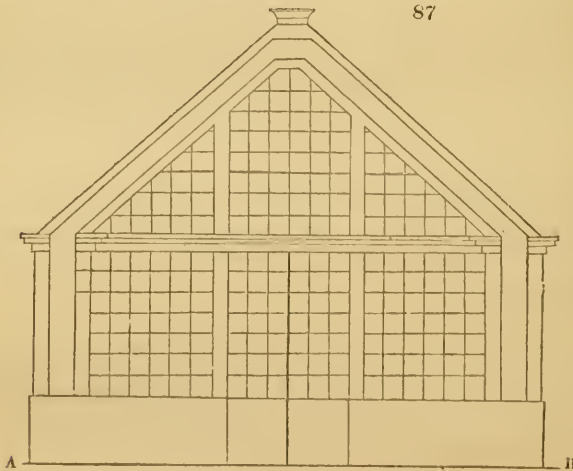

Fig. 86. Side view of the same.*Fig. 87.* Section on the line A B.

In England, and in the southern parts of the Continent, it is probable that this method could not be employed with so much advantage as in Germany or Russia; but in more northern climates it deserves some attention; and there is no doubt that, as it becomes more general, other improvements will suggest themselves. As I do not find this plan mentioned in any work on gardening, I have transmitted the present description of it, accompanied by a sketch for your inspection.

I am, Sir, yours, &c.

CHARLES RAUCH.

May, 1832.

ART. VII. *A new Mode of training Fruit Trees ; a new Mode of grafting and inarching ; and an improved Mode of making Gooseberry Wine and Cider, &c.* By Mr. W. GREEN, JUN.

Sir,

HAVING seen in the Gardener's Magazine descriptions of various methods of training wall trees, I take the liberty of sending the description of what I call my method, as I have never seen or heard of its having been employed by any other person but myself, and I have used it for several years with success, particularly on long low walls.

Pear Trees.—Every one who has paid any attention to training pear trees horizontally, must be aware of the length of time required to fill a wall with shoots at equal distances ; and that this can only be accomplished, according to the usual method, by heading down the leader every year. This operation does not always produce two lateral shoots, and it is not only tedious, but it has also a tendency to make the shoots already produced grow more rank than is desirable. By my method this is avoided, and the wall is much sooner filled in height with shoots : it is as follows :—

If the wall is under 20 ft. long, and it is intended to train a pear tree against it, plant the tree at one end of the wall, and then proceed as follows :— Let the situation of the tree be at *a*, in *fig.* 88. : stick a nail in the wall at *b*, and another nail at

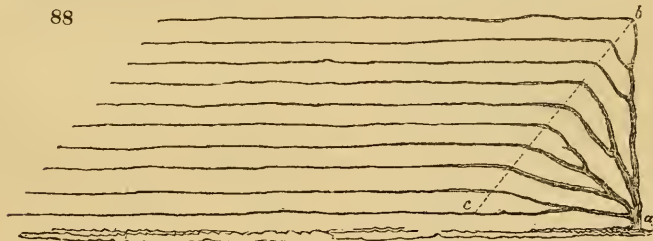

c, and strike a line on the wall from *b* to *c* ; then train all the shoots to one side after the fan manner, and bend the whole of the shoots into a horizontal position, as soon as they reach the line that is drawn from *b* to *c* ; after which continue to train them horizontally.

If the wall is from 30 to 40 ft. in length, plant the tree in the middle of it, at *d* in *fig.* 89, and proceed as follows :— Stick a nail in the wall in the centre, near the top, at *e* ; stick another nail at *f*, and another at *g* : then strike a line from *e* to *f*, another line from *e* to *g* ; train the tree in the fan manner, until the shoots reach the lines drawn upon the wall, and then bend them horizontally.

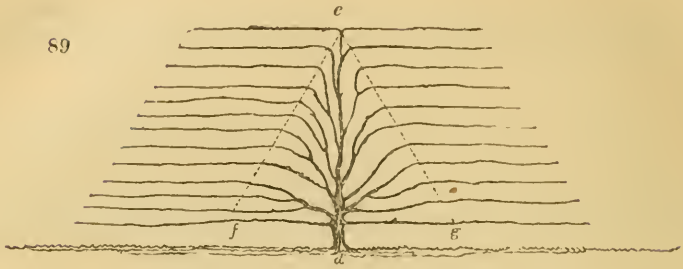

If the wall is higher than it is wide, proceed as follows: — Plant the tree in the middle of the wall at *h*, in *fig. 90.*; stick one nail at *i*, one at *k*, and one at *l*: strike the lines as before; but, instead of spreading out the shoots horizontally, train them perpendicularly. This process answers well also for vines, or any other rank-growing tree.

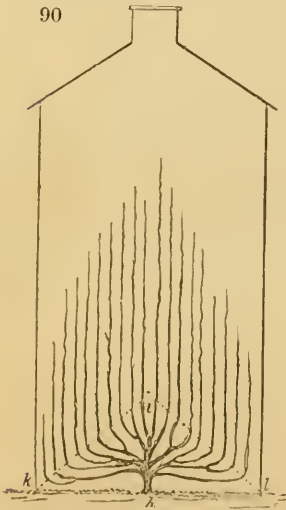

New Method of grafting by Approach. — Cut off the stock in the form of a wedge, as in *fig. 91.*, and cut the graft upwards, half way through, for a sufficient length, as in *fig. 92.*; then place the graft upon the stock, as in *fig. 93.*, and bind it on with bass and clay as usual, taking off a circle of bark between the graft and the root, as in *fig. 93. m*, which will cause the sap to flow

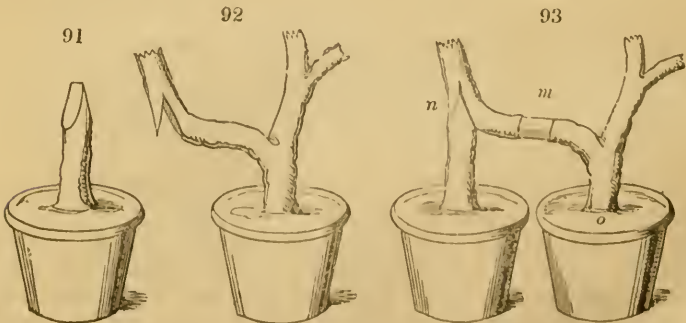

through the graft into the stock *n*, instead of into its own root *o*. I recommend this method for grafting, whenever the stock and the graft are of the same size, or very nearly so; but I recommend the following modification to be employed, when the stock is twice the size of the graft:—

Cut off the top of the stock slanting from one side only, so as to form about a right angle, *fig. 94*. Then make a long

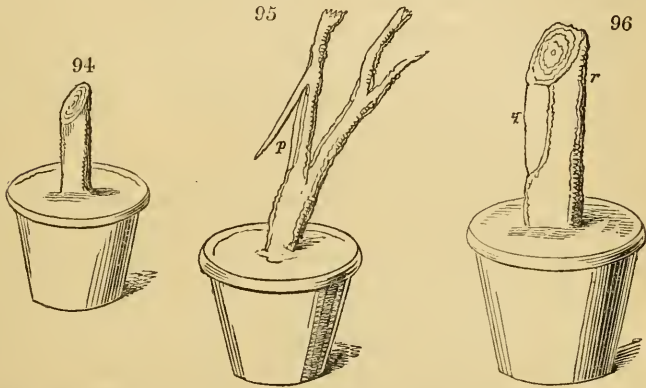

tongue to the graft, about one third of its thickness, *fig. 95*. *p*, and cut as much of the bark and wood from the back and front of the stock as will correspond with the width of the tongue on the graft; when the stock is ready to receive the graft, it will appear like *fig. 96*. *q*: there must be also a piece cut off the back of the stock at *r*, *fig. 96*.; but it is not seen in the drawing. Then place the graft across the middle of the stock, as in *fig. 97*., and bind it with bass and clay as usual;

after which take off a ring of bark at *s*, in *fig. 97*., in the same manner as was directed for *fig. 93*.

English Champagne Wine. — I send you a receipt for this wine, which, though perhaps not new, certainly produces the best imitation of foreign wine we have, and, when properly made and properly managed, it has deceived some of the knowing ones

To every pound of gooseberries (full grown, but not changed colour for ripening) well crushed, add one pint of cold soft water; let them stand till they begin to ferment; then press out the liquor, and to every quart of it add one pound of loaf sugar: fill the cask quite full, and keep it full up to the bung-hole, so that the scum and yeast which are formed on the wine may work out. When the strong fermentation is over, but before it has done hissing, add to every nine gallons half an ounce of the best isinglass, dissolved in cold cider, and let it be well stirred about for a quarter of an hour: after this, the wine must not be stirred or disturbed, but, as soon as it is fine, it must be bottled in strong champagne bottles, and wired down.

I am well aware that scientific chemists will say that the finings ought not to be added until the wine has ceased to ferment; and in all other cases of wine-making I admit this to be correct: but in the present case I find that it is best to add the finings at the period I have named, as it is most desirable to get the champagne fine as soon as possible; for, upon this, and its being bottled, corked, and wired, the moment it is fine, depends the success of the process. If you wish to colour it pink, pour some boiling water on some cochineal, bruised, and put in a basin; let it stand all night, and then strain it through a piece of cloth, and add as much as will give it the colour desired.

It will be found a very difficult task to crush the gooseberries sufficiently, unless a proper crushing mill is employed. I here subjoin a plan of one I always use for crushing both gooseberries and currants. The apparatus consists of a box with four sides, but without either top or bottom. *Fig. 98.* shows the ends

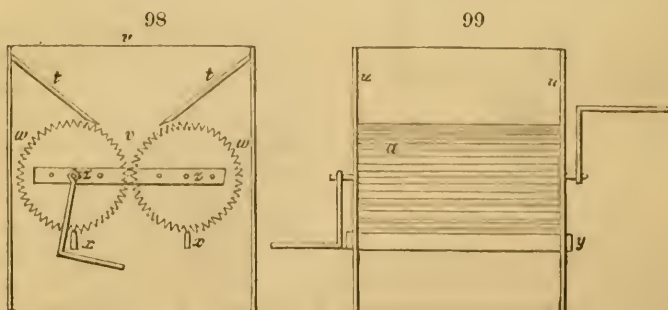

of two rollers, 9 in. in diameter, and 12 in. long, each; and *fig. 99.* shows the whole length of the same rollers, which ought to be made of good clean ash; for, if they be made of beech,

the worm gets into them, and they soon become like a honey-comb, which renders them unfit for service. The rollers must be grooved the whole length of the surface; the grooves ought to be half an inch wide, and three eighths of an inch deep; an iron spindle passes through each roller, and upon these spindles there is, at each side of the box, a crank handle fixed by a nut, which screws on one end of each spindle. In *fig. 98. t t* show the ends of two boards, which go the whole length across the box from *u* to *u*, *fig. 99.*, and from a hopper (*v*, *fig. 98.*) which guides the fruit between the rollers, and keeps it from getting behind them at *w w*. In *fig. 98. x x* show the ends of two pieces of board, which pass through mortises in the sides of the box, and act as scrapers to the rollers: *y*, *fig. 99.* shows the whole length of the same pieces of wood. The dimensions of the case or box are, 4 ft. high, 19 in. by 12 in. inside. The spindles for the rollers are seven eighths of an inch thick, and work through two plates (*z z*), which are let into the sides of the box, and are 2 in. wide by half an inch thick, and 16 in. long each. These plates are not only necessary for the spindles to work in, but they prevent the contraction and expansion of the sides of the box; which, without this precaution, would sometimes contract, and jamb the rollers so close together that they would not turn; and at other times would expand, and keep the rollers too far apart. I also send you the plan of the press I use, though I am afraid few persons will be found who will go to the expense of one of such power; however, presses of a similar construction may be made of any size or power required.

In *fig. 100. a* is a screw, 3 ft. 9 in. long, and 2 in. in diameter, which works in the brass nut *b*, let into the head-piece of the press on the under side: *c* is a piece of cast iron, 4 in. by 2 in., which goes across the top of the fall-board, for the screw to work upon: *d* is a square iron clip that is fastened across the iron *c*, and under which is placed an iron collar, that is put upon the lower end of the press pin, and enables the pin to raise the fall-board, when the press pin or screw is turned back. The head of this pin is 4 in. in diameter, and it has two holes through it, at right angles, through which the end of the lever is put when the press is worked. The lever is made of iron, and is 4 ft. 6 in. long, by $1\frac{3}{8}$ in. in diameter, and has a collar 6 in. long from one end, to prevent the lever from slipping too far through the head of the pin. A hole (*f*) which is three fourths of an inch in diameter, is bored through the bed, to let the juice run down into a pail, or any other fit vessel, placed underneath the bed: *g* is a groove 1 in. wide, and forms an inclined plane, which commences at

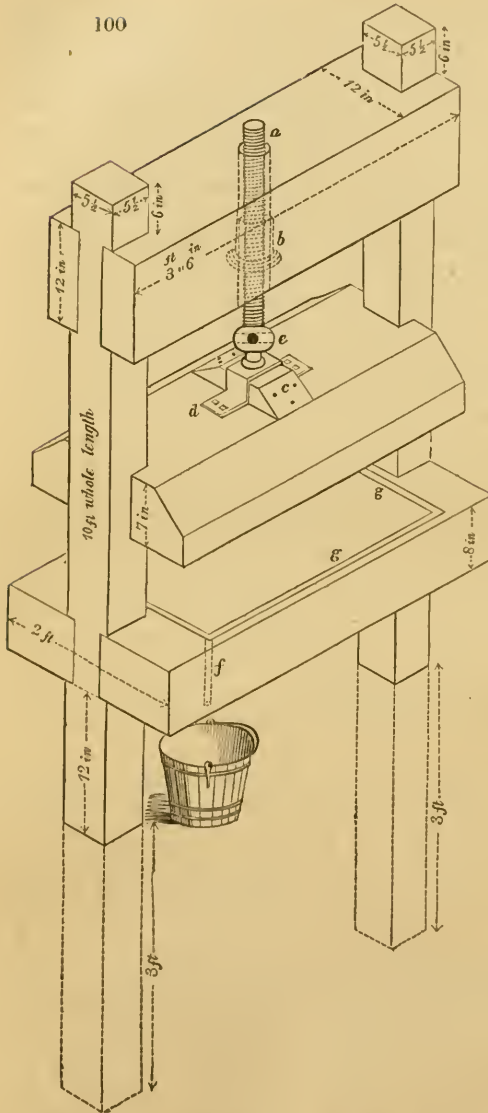

h, *fig.* 101., where it is only half an inch deep, but it increases in depth, till it arrives at the hole *f* in *figs.* 100. and 101., where it is an inch deep. *Fig.* 101. represents the bed detached from the press, to show the form and course of the groove by which the juice runs off.

When the fruit has been crushed, and has lain a proper time, it must be put into a large hair sieve, and when it has drained sufficiently, it must be laid upon haircloths (made of horse hair); each cloth must be about a yard and a half long, by a yard wide, and must be carefully hemmed at the ends, to keep them from ravelling. Lay a cloth on a wide board or table, and lay as much of the crushed fruit in the centre

of it as you conveniently can; then double first one side of the cloth over the fruit, and afterwards the opposite side of the cloth over the first; then double one end over that, and, lastly, the other end over all. When this is done, place the cloth containing the fruit on the middle of the bed of the

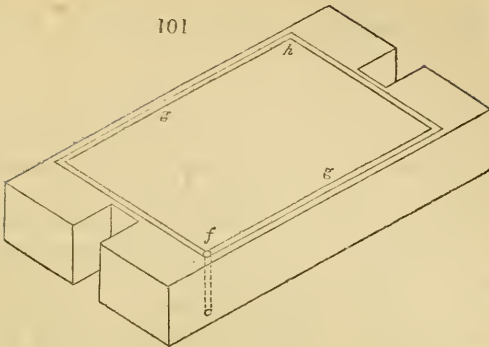

press, and lay two or more upon the first (three in all, or as many as the press will hold), and then with the lever work the screw down as tight as you can. It will be necessary to watch the action of the press, to see that the fall-board descends perpendicularly; for, if it does not, the patches must be shifted, or the fall-board will jam crosswise, which will increase the labour greatly, and also assist in wearing out the press. When the cloths are cleared of the fruit after they come out of the press, they must be hung across a line or rail: for, if they are allowed to lie together, they will heat in a very short time, like a fresh dunghill; and, in a much shorter time than will be credited, will rot. After they are done with for the season, they must be carefully and thoroughly washed in different waters, and dried before they are put away. Every precaution must be taken to preserve them from moths, or they will, in a very short time, be entirely unfit for use, as the moth appears to be very fond of them.

Haircloth may be purchased at almost any sack and tilt warehouse.

It may be observed, that the cloths, when folded with the fruit in them, are called patches; and that these patches, when placed in the press, must be laid with the ends of the cloths undermost.

The uprights or standards of the press must be made of heart of oak, or they will soon rot in the ground; and the other wooden parts of the press must be made of dry elm.

I am, Sir, yours, &c.

W. GREEN, jun.

Stepney, May, 1831.

ART. VIII. *Observations on several Gardens in England.*
By Mr. W. SANDERS.

(Continued from Vol. VII. p. 139.)

EVERLY HOUSE, the seat of Sir John Ashley, Bart. — June 28.
1830. This place is much improved in appearance since I last saw it (in the summer of 1825); arising, in a great measure, from the rapid growth of the plantations which enclose the park, while the interior presents a more finished and orderly aspect, and evidently shows that it is under the care of an able manager. The kitchen-garden is a neat and well-arranged model, well worthy of imitation; the walls have been in part rebuilt, and have had 2 ft. added to their height. They are well stocked with fine healthy fruit trees. In the framing department, neat and compact pits have been erected for melons and cucumbers; the melons were growing luxuriantly in turf loam procured from Salisbury Plain, which appeared of an excellent quality. It may be here remarked what a wide field for improvement this extensive waste presents, and how many thousands of the almost starving population might be employed in the cultivation of this now comparatively useless tract of land. A great proportion of it is little inferior in quality to that alluded to above. It would afford a fair field for the introduction of the excellent system of cottage husbandry, which in a very short space of time would go far to ameliorate the condition of the industrious peasant, and to ease the shoulders of the farmers from that burden which now presses so heavily upon them, in the shape of poor's rates. In a neighbouring parish, a similar plan has been pursued for some years by a noble marquis, who has allotted a large garden to each of his cottages; and the result has been, that the rates have not risen in any thing like the proportion they have done in other parishes around; while the farmers, though at first much opposed to the plan, are now delighted with the good effects it has produced. Much in this way might be done by private gentlemen in their respective neighbourhoods; and it would surely be worth the attention of the legislature, to devise some means to stem the tide of emigration, while so much remains to be done at home. But to return to the garden at Everly, Mr. Ross has, by considerable perseverance, collected a very respectable assortment of herbacons plants, so arranged in the beds they occupy as to present a succession of flowers during the season; while, as particular attention has been paid to their various heights, they meet the eye with a

very pleasing effect. On leaving a well-kept lawn adjoining the house, I found some of the finest balsams in flower I have ever seen. Most of the flowers measured $2\frac{1}{2}$ in. in diameter, perfectly double, and with the petals laid out with all the regularity of a well-blown camellia. Mr. Ross's coxcombs were also very fine.

Amesbury House, Sir Edward Antrobus, Bart., near Amesbury.—*June 29.* A small place; the house standing in the centre of a tastefully laid out lawn, interspersed with beds of shrubs and flowers in high keeping. It seems a march behind its fellows with respect to the choicer productions of Flora; probably because, from its secluded situation, the gardener is prevented from having a ready notice of the more lately introduced ornamental flowers. The kitchen-garden is surrounded by mud-built walls, about 7 ft. high, thatched on the top with straw, which projects about 6 or 8 in. The peach and plum trees were looking extremely well, and there was an excellent crop, with hardly the least speck of blight or mildew to be seen. Mr. Bike said they seldom failed of having a good crop; and he attributed that, and their very healthy appearance on such an otherwise exposed situation, to the thatch and warmth of the walls. The natural soil is chalk; but the borders had received a little assistance by the addition of a portion of fresh soil and manure. The projecting thatch may in a great degree accelerate the ripening of the young wood, by preventing the ready escape of the heated air, which, in ordinary cases, has no barrier. These walls, while kept dry, are very durable, but of course do not stand nailing well; pegs were driven in at intervals, to which the trees were fastened. The manner of erecting such walls is very simple. Two strong boards are bolted together to any desired width, according to what may be the intended thickness of the walls; and having prepared a firm foundation, the frame formed by them is filled with loam or clay, mixed with a slight portion of gravel, which is beaten down firmly with an iron rammer; taking care, however, that the quantity put in at one time is not too great, as, in that case, the mass will not be properly consolidated, and afterwards may become liable to crack on becoming dry. The loam or clay must not be more than just moist, or in that state in which it is dug. When dry, the whole may be plastered, and afterwards blackened, which would be an additional attracter of heat. Instead of thatch, projecting tiles might be used, and a wire or wood trellis to train the trees to. The whole might thus be rendered any thing but an unsightly object; and, where bricks or stones are difficult to be obtained

in the immediate neighbourhood, this description of wall will form an excellent substitute.

Longford Castle, the family residence of the Earl of Radnor.—*July 1.* A richly wooded park, presenting little variation of surface, and chiefly lying very flat. The castle and gardens are situated on the banks of the river Avon, and part of the castle was begun to be rebuilt during the latter part of the late earl's time, but the completion of it is for the present suspended. The kitchen-garden contains nearly four acres, with excellent walls, and is in high keeping. On being ushered into it, an almost unparalleled scene presents itself. Nothing can exceed the superior arrangement, and the neatness and order observed in the forcing departments; the borders are covered with the gayest flowers, while on the walks there is not a single patch of weeds, or a bit of straw, to be seen. All is so well arranged, that little or no extra-care is requisite for keeping it in this state. The linings which surround the pits are covered with oak boards, lying on a gentle slope, supported by brickwork, which are of such lengths as to admit of two men placing them on the walk immediately around the pit, when the linings require renovation; and over these boards the dung is wheeled, so that the walk receives no injury. Drains conduct the water collected from the roofs of the pits and houses to a tank, from which water is taken for the use of the garden. The pits are built with double walls, the outer one pigeon-holed as high as the covers of the lining. In the interior wall are a number of holes for the admission of steam at pleasure, by withdrawing the plugs; and the vacuity between the walls is about $2\frac{1}{2}$ in. In these pits, pines, melons, and cucumbers were growing luxuriantly. The arrangement of the whole garden was so superior, that it induced me to take a plan of it (which, through the kindness of Mr. Christie, I was enabled to do), thinking that such a model might be worthy the attention of gentlemen about to lay out or renovate their gardens. (See *fig. 102.* and its references.) The wall trees had suffered severely these last two seasons by blight.

The pleasure-grounds are intersected with romantic walks along the banks of the river, here and there having a delightful peep of the water and its opposite shore, until you are led to a small flower-garden, laid out some sixty or seventy years ago, which occupies the point between the Avon and a rivulet where they meet, as shown in the plan, *fig. 103.* This spot is delightfully retired, being shut in by wood on each side, and seems as if reserved as a last retreat from the busy scenes of life. Here is quietness only interrupted by the

102

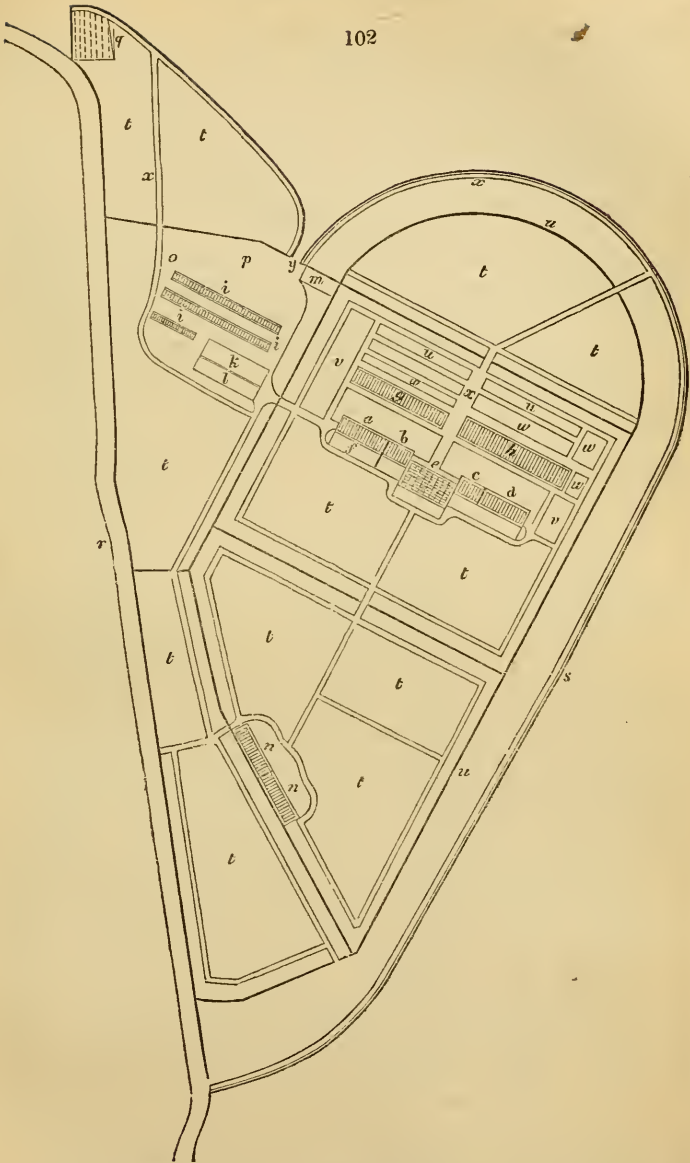

- a*, Pine stove, heated by hot-water pipes: the flue from it heating a mushroom-house (*f*) on Oldacre's plan. *b*, A plant stove. *c* and *d*, Vineries. *e*, A green-house. *f*, Mushroom-house. *g*, Cucumber and melon pits. *h*, Pine pit. *i i i*, Common dung frames. *k*, Potting shed. *l*, Pot-shed. *m*, Coal and cinder shed. *n n*, Peach-houses. *o*, Compost ground. *p*, Pump. *q*, American cranberry patch. *r*, A brook, which runs along under the east wall. *s s*, Walls which form the boundary. *t t t t*, Quarters under culinary vegetables. *u u*, Garden walls. *v v*, Beds of standard and dwarf roses intermixed. *w w*, Beds appropriated for choice herbaceous plants, new annuals, pelargoniums, &c. *x x*, Walks. *y*, Gateway for carts, &c.

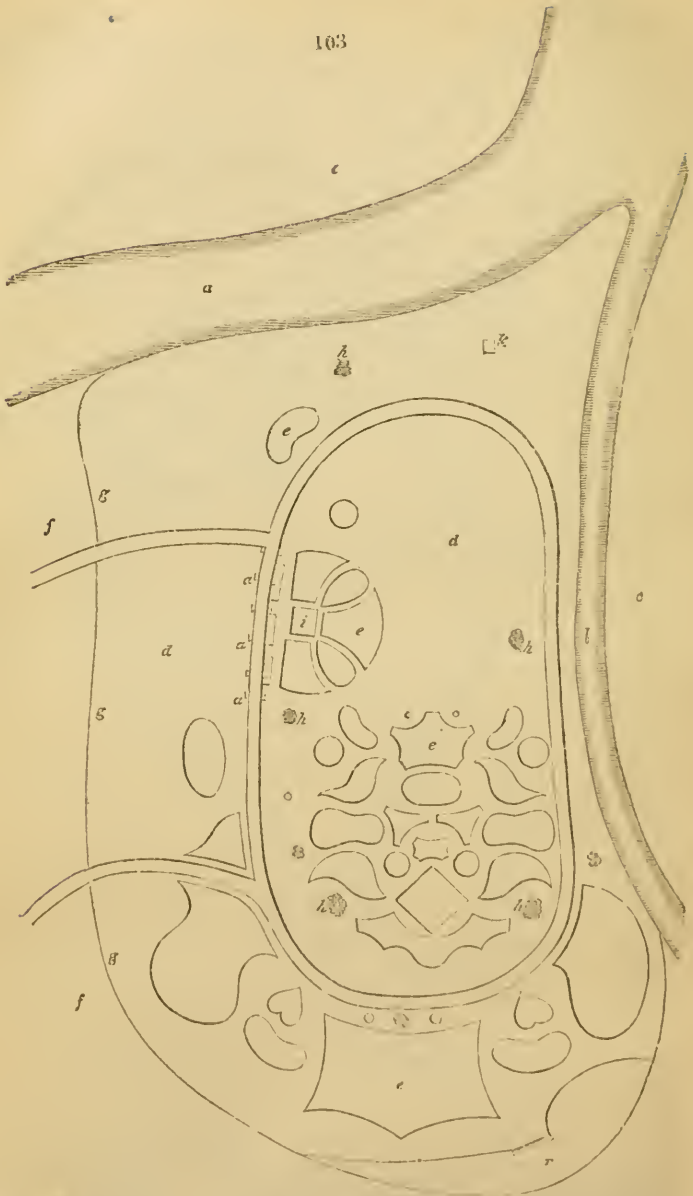

a, The river Avon. *b*, The brook represented in *fig.* 102. by the letter *r*.
cc, Plantations. *dd*, Lawn. *ee*, Flower-beds.
ff, Woods, which connect the flower-garden with the park and castle.
ggg, A margin of rhododendrons and other American shrubs, which connect the woods with the lawn.
hh, &c., Roots and stumps of trees, ornamented with elegant creepers.
i, A templo, or covered seat, dedicated to Flora. *k*, A sundial.

gentle breeze, or murmuring of the waters, or an occasional splash of the finny tribe; and these are hardly sufficient to break the spell which such a situation casts over the mind. Such an appendage to the mansions of the great (wherever attainable) is, in my opinion, truly desirable. This garden contains an exceedingly good collection of herbaceous and other flowers, and is in equally high keeping with the other portions of the grounds. Several stumps of large old trees, covered with creepers, such as *Verbena chamædrifolia*, &c., are introduced in it with very good effect; but the beds appeared too crowded to show themselves properly. Lady Radnor, who is a warm encourager of horticulture, sent her gardener to Paris, in the summer of 1829, to see the principal gardens, &c., there, and to collect what he possibly could that was new and rare.

I am, Sir, yours, &c.

London, April 13. 1831.

WM. SANDERS.

ART. IX. *Design for a Gardener's House, containing Five Rooms and an Office; adapted for being connected with the Wall of a Kitchen-garden.*

A VALUED friend, an architect and an enthusiastic amateur of horticulture, now travelling in Scotland, has elsewhere, in this Magazine, suggested to us the propriety of giving plans of gardeners' houses, connected with the walls of the kitchen-garden. Country gentlemen, he says, cannot so readily conceive how the detached plans of dwellings, which we have given in our *Encyclopædia of Cottage, Farm, and Villa Architecture*, can be applied to the sort of lodges which they generally erect as lean-tos to the walls of their kitchen-gardens. We intend to comply with his suggestion; and, with the assistance of our architectural draughtsman, to give eight designs in this Magazine, totally different from any in the work just mentioned, and especially calculated for the four sides and the four corners of kitchen-garden walls. Like true freemasons, we shall commence with a design for the east wall of a garden.

This design contains a cellar floor (*fig.* 104. *c*), in which are an under-kitchen or wash-house (*a*), and a beer-cellar (*b*). In the former is an oven, the flue of which is conducted under the kitchen floor, and that of the passage (*c*), gardener's office (*d*) adjoining, and parlour (*f*), for the purpose of heating them in the manner described in Vol. VI. p. 157, to which we beg

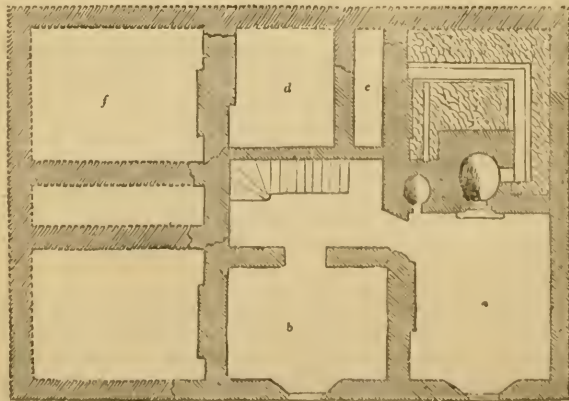
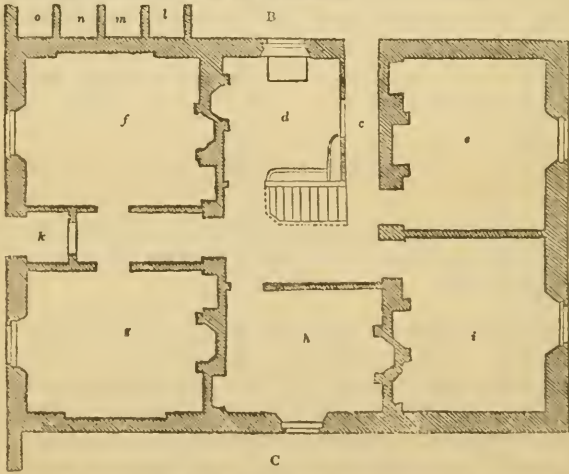
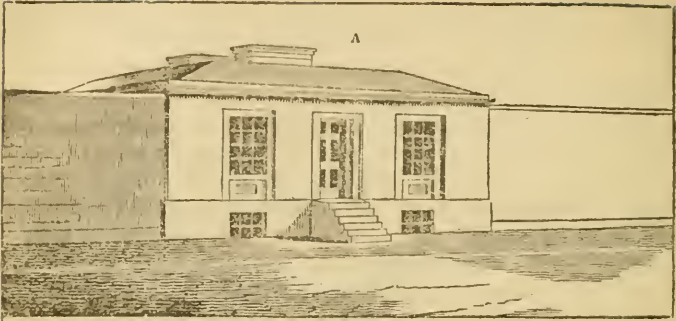

Fig. 10 5 10 20

to refer our readers for the more complete understanding of this plan. There is also a boiler, the flue of which is likewise conducted under these floors.

All the rooms of this dwelling are on one floor (*fig.* 104. B), which will be rendered perfectly dry by the cellarage below, as well as by being raised six steps (3 ft.) above the surface of the garden. This floor shows the back entrance (*c*), gardener's office (*d*), fitted up with book shelves, and a large desk, with drawers for seeds under; and having two doors, so that the men may come in and receive payment by the door which opens into the back entrance. There are a kitchen (*e*), parlour (*f*), master's bed-room (*g*), two other bed-rooms (*h* and *i*), and an entrance porch from the garden (*k*). It will be observed that the window of the parlour, and that of the master's bed-room, look into the garden, which ought always to be the case in such houses, for the convenience of inspection both by night and by day.

At the back of the house there should be a lean-to, in which may be placed the coal-bin (*l*), wood-bin (*m*), dusthole (*n*), and privy (*o*). A pigsty might easily be added, and also a cow-house; but the latter appendage is generally better in the yard of the demesne farm.

In some cases it may be desirable to have the fruit-cellar under the gardener's house, and in this plan it might very easily be formed under *g* or *d*; in the latter case, limiting the course of the flues to the floors of *e* and *c*.

The construction of this dwelling, and the materials to be

105

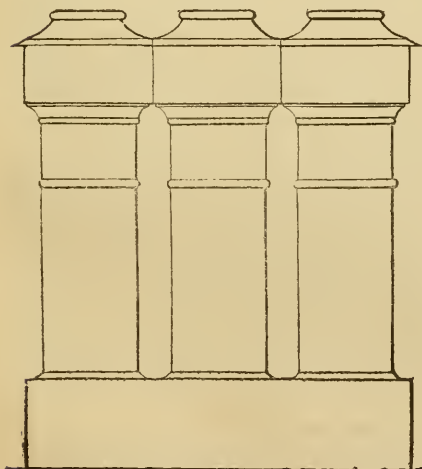

106

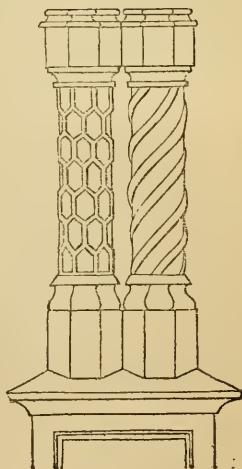

107



employed in it, we leave to be determined by local circumstances. We have shown the roof and the chimney-tops low, because it is seldom desirable to render houses in such situations conspicuous objects; but should this be not the case, handsome chimney-pots of artificial or natural stone, such as *figs.* 105, 106, or 107., may be added, with or without basement plinths. These, and numerous other handsome forms of chimney-pots, are manufactured in London by Austin, at very moderate prices; and they might be imitated, either in real stone, or in earthenware, at any good pottery.

ART. X. *Notice of some new Cast-Iron Flower Stakes, and some small Wrought-Iron Stakes for Peas or Annuals, invented by Robert Mallet, Jun. Esq. Communicated by Mr. MALLET.*

Sir,

SOME days since, I sent you some patterns of flower stakes, which I have lately got made, and of which, I believe, I am the first inventor. The cast-iron ones (*fig.* 110.) are, I think, an improvement upon Cottam and Hallen's (which were figured in Vol. VII. p. 284.), as they can be cast much longer than is possible with theirs (the weights of both being equal), and they combine great strength with lightness. They take also a good grip or hold of the earth, from their extended wings at bottom.

I sent also a small wrought-iron pea or annual stake chiefly intended for culinary or sweet peas, either in hedges or clumps. *Figs.* 108. and 109. will fully explain their application with the addition of wires.

108

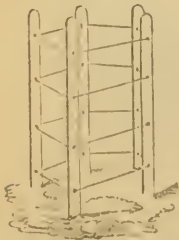
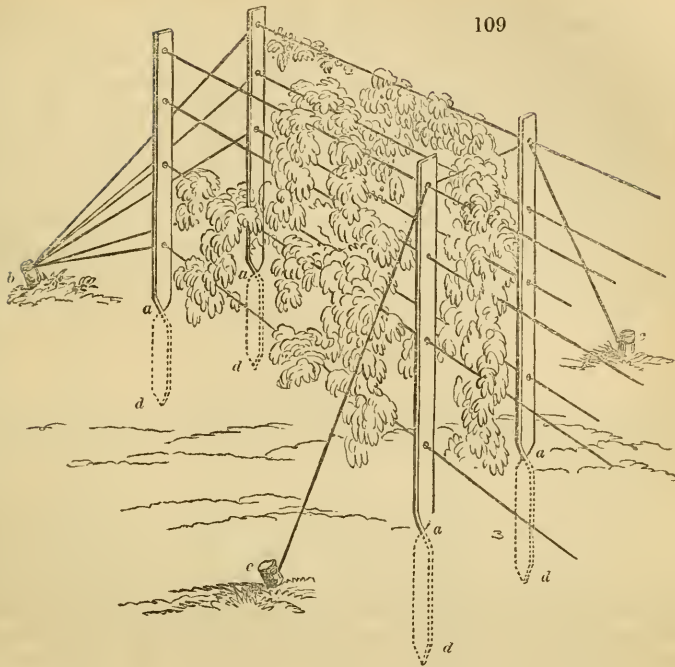

Fig. 109. is intended to represent part of a sweet-pea hedge. Each stake is twisted cold at *a*, 90° ; by which means, it opposes its flat face to the earth in which it is stuck (*a d*), and in the proper position to resist any motion of the hedge sidewise. The connecting cords may be either of wire or twine; when they are for sweet peas to be sown every season, they may be permanent, and of wire; but when they are to be moved

they should be of twine, boiled, previously to being strained, in a solution of Indian rubber in pyroligneous ether (a



product of the pyroligneous acid makers, and known on the Continent by the name of pyroxylic spirit). The expense of this is trifling: $1\frac{1}{2}$ oz. of Indian rubber and $1\frac{1}{2}$ pint of the ether will saturate 10 lbs. of twine. The twine need never be varnished again, and will last many seasons; is perfectly impervious to wet, and is not affected by hygrometric changes in the atmosphere; so that, when once strained tight by the stakes at *b*, it will remain so.

I have these stakes in use, and they answer admirably, and look exceedingly neat. I should think, about London, where pea stakes are so dear, this would be the cheapest plan market-gardeners, &c., could adopt. Occasionally, in very long ranges, a stay or two in the length may be placed as shown at *c c*. It is obvious that these stakes are applicable also to clumps or baskets, but the cord should then be arranged spirally through the holes. They are much stronger than the wire things generally used, and may be varied to any size or shape.

I am, Sir, yours, &c.

ROBERT MALLET.

94. Capel Street, Dublin, July 4. 1832.

THE stake *fig. 110.* is 7 ft. long, and weighs 1 cwt. 8 lbs. per dozen. *Fig. 111.* is 5 ft. 2 in. in length, and weighs 2 qrs. 13 lbs. per dozen. *Fig. 112.* is 3 ft. 8 in. in height, and weighs 3 qrs. 9 lbs. per dozen. It will be observed, by comparing the above weights and heights with those of Messrs. Cottam and Hallen's cast-iron flower stakes, as given in the succeeding article, that Mr. Mallet's are somewhat lighter. Mr. Mallet has subsequently made the improvement in the form of the foot of round stakes (such as those of Mr. Cottam), indicated by the sketch, marked *a*, on the opposite page. Stakes thus formed will weigh less, and take a firmer hold of the ground. — *Cond*

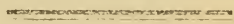

ART. XI. *Notice of the Cast-Iron and Wrought-Iron Flower Stakes manufactured by Messrs. Cottam and Hallen, London.* By the CONDUCTOR.

KNOWING the introduction of iron stakes in flower-gardens to be a very great improvement, in point both of economy and neatness; in order that our readers may know the sizes and prices, and also compare the appearance of those of Mr. Mallet with those of Messrs. Cottam and Hallen, we have given figures of the different sorts manufactured by the latter firm.

Fig. 113. shows the four sizes of cast-iron stakes, manufactured by Messrs. Cottam and Hallen. The height of the first (*a*) is 7 ft., its weight per dozen 2 cwt. 1 qr., and the price per dozen, 25s.; *b* is 6 ft. high, weighs 1 cwt. 2 qrs. 22 lbs. per dozen, and costs 18s. 6d.; *c* is 5 ft. high, weighs 1 cwt. 1 qr. 16 lbs. per dozen, and costs 16s. 6d.; and *d* is 4 ft. high, weighs 40 lbs. per dozen, and costs 10s. 6d.

Fig. 114. shows the different sizes of wrought-iron rods let into cast-iron sockets at bottom. The height of the first (*e*) is 6 ft. 6 in., and the price is 10s. 6d. per dozen; of the second (*f*) 5 ft. 6 in., the price is 9s. 6d. per dozen; of the third (*g*) 5 ft., the price is 8s. 6d.; of the fourth (*h*) 4 ft. 6 in., the price is 8s.; of the fifth (*i*) the height is 4 ft., and the price 7s.; of the sixth (*k*) the height is 3 ft. 6 in., and the price per dozen 6s. 6d.; of the seventh (*l*) the height is 3 ft., and the price 6s.; of the eighth (*m*) the height is 2 ft. 6 in., and the price 5s. 6d.; and the ninth (*n*) is 2 ft. in height, and the price per dozen is 5s.

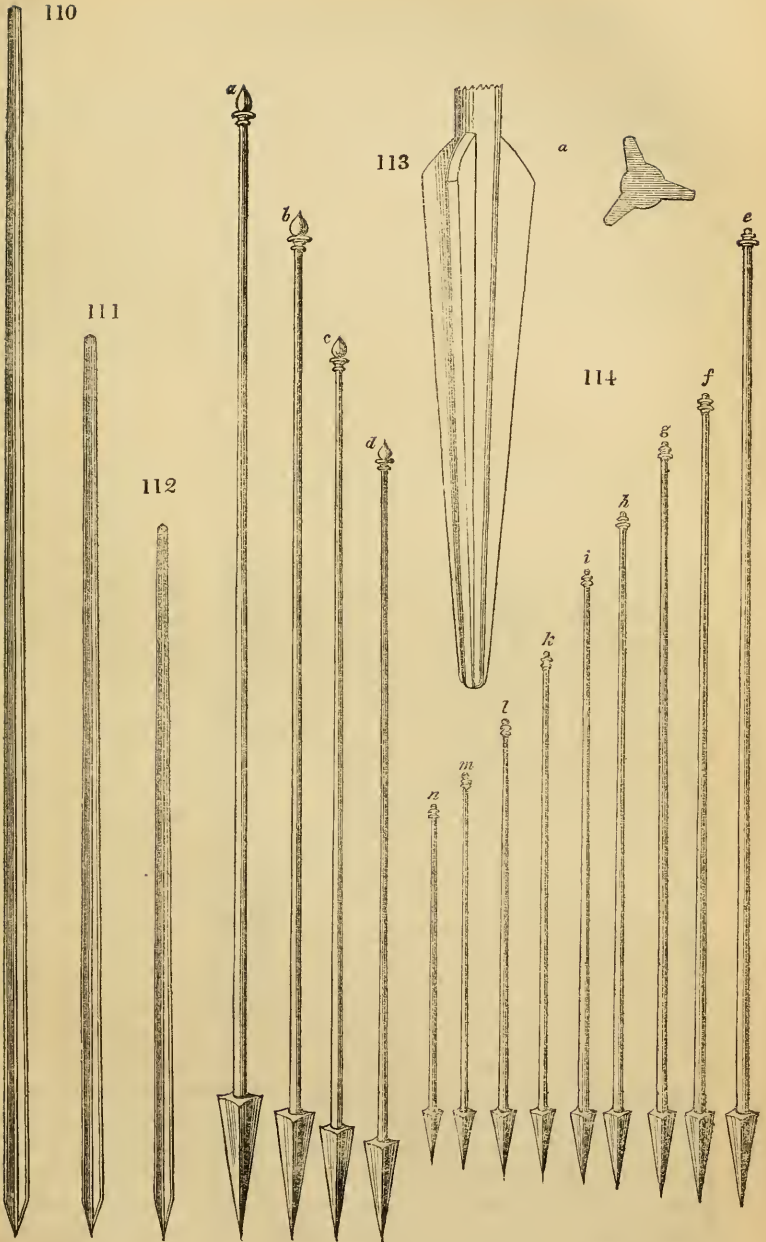

ART. XII. *Notice of a newly invented Hoe.*
By JOHN BOOKER, Esq.

Sir,

I BEG leave to send you a sketch of a hoe (*fig. 115.*) which I invented for my own use, and which I do not recollect to have

115

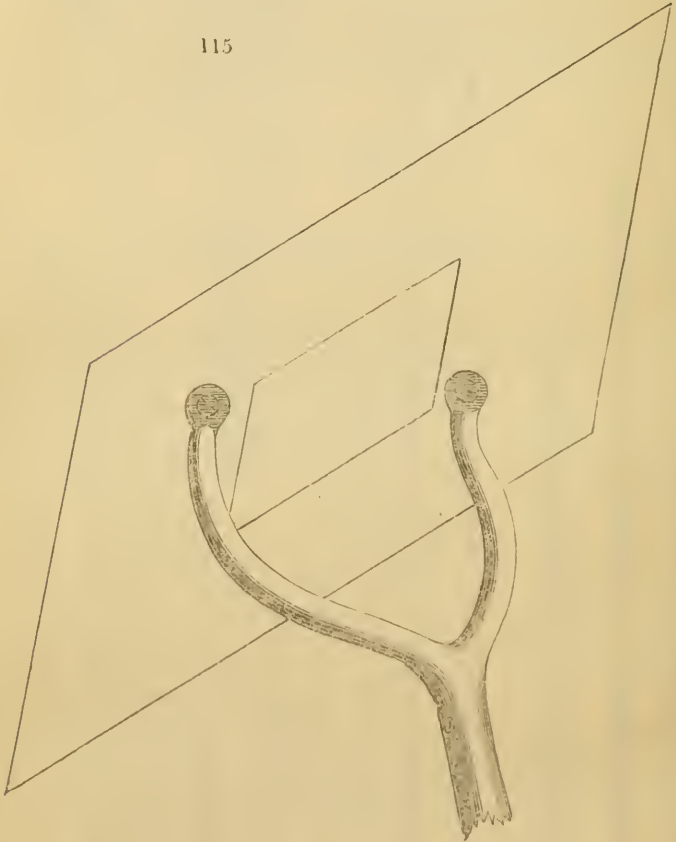

seen among the implements figured and described in your *Encyclopædia*. This hoe cuts every way; backwards, forwards, and on both sides. It does not remove much earth; it cuts best as it moves diagonally, backwards or forwards; but cuts well moved in any direction. I find it particularly useful among things planted in rows. My gardener, a Russian, who has a great dread of novelty, after he had got over his first hor-

rors at the sight of this new implement, reluctantly consented to try it in the garden; and, at last, liked it so well, as to order several for general use. Should you wish to have one, I shall have great pleasure in sending it to you.

I am, Sir, yours, &c.

Cronstadt, Russia, June 4. 1832.

JOHN BOOKER.

WE shall be happy to receive a hoe, which we will send to Messrs. Cottam and Hallen's, to be manufactured for general use. We shall be still more obliged by the various articles mentioned by our liberal and benevolent correspondent, as suitable for our *Encyclopædia of Cottage, Farm, and Villa Architecture*. — *Cond.*

ART. XIII. *On Transplanting large Trees, Pruning, &c.*
By Mr. HOWDEN.

Sir,

I AM sorry to see, in a late Number of the Gardener's Magazine, that the art of gardening is falling into decay; that many respectable nursery and seedsmen have become, or are becoming, insolvent; and that more head-gardeners are out of employ than the nurserymen can find work for. This, I should think, will have a good effect in making all upstart gardeners humble and submissive. I also find, by the review of Mr. Ellis, that there has been a Sir Henry Steuart, who has written a book, wherein he stigmatises the generality of gardeners as a set of self-sufficient ignoramuses. This is indeed "the unkindest cut of all." The gardener, who has all his life studied the nature of the vegetable kingdom, who can call ten thousand plants by their proper names, and who knows their nature, can no more be an ignorant man than the officer in an army of soldiers who can call on every one of his army by name to do his duty. But up starts a Sir Henry Steuart, who, like a Sir Hew Dalrymple, snatches the victory out of the hands of the poor operative. Allow me to lend a helping hand to retrieve the falling fortunes of the poor defenceless gardeners, and to show that we are not so very ignorant as he supposes us to be. Sir Henry Steuart has written a book in a fair legible hand; for this reason, he has had a better, or rather a more expensive, education than most gardeners: but, as to his *inventing* the machine he talks of, the thought is quite laughable; the machine was invented before I was born, and any practical gardener could invent a

better in five minutes, after seeing the size of the trees to be removed. The miller or warehouseman's truck, or trolley, on a large scale, is a better machine than that of Sir Henry Stuart. Such a truck, when brought down to the balance, rests on another pair of wheels, and may be transported any where. The origin of the idea is as simple as seeing a boy carrying a young shrub on his spade to transplant it; but when the shrub or tree is large, a pair of wheels, or even two pair, must be fixed to the spade, and the spade must be large and strong in proportion; four ropes fastened near the top of the tree, and to four staples at the corners of the spade bit, will hold the tree as upright as the mainmast of a ship. The spade handle need not be fixed permanently to the blade or bit, but may be taken out or put in at pleasure, like a handspike for weighing a ship's anchor. Sir Henry Stuart has been very fortunate in having so many fine old trees left him by his ancestors, who, it seems, were so "ignorant and self-sufficient" as to plant them all in the wrong places. It will be well if his successors be not so ignorant and self-sufficient as to think they are all in their wrong places now; and if they do not invent a machine to remove them all back to their old stations. As poor Richard says —

"I never saw an oft-removed tree,
Nor yet an oft-removed family,
That throve so well as those who settled be."

While a tree, or a man, is young, and full of sap and life, they may and ought to be transplanted into various nurseries; but it is impossible to transplant an old man or old tree without giving them such a shock, or check, as they seldom or never get the better of. It is impossible to transplant a tree of any age, without damaging some of the roots; and they require a similar deprivation of branches to the loss of roots. This leads me on to that queer word *physiology*, I think they call it. Some people are of opinion that the branches, twigs, and leaves assist the growth of timber; and a certain author, Mr. Withers, compares the leaves of the tree to its mouth. I would advise such authors to shut their mouths till they can open them to better purpose. I could have excused him if he had called them nostrils; but mouths—oh, shocking! I should rather call them the mere excrements of the tree, else why does the tree discharge them annually. If the leaves of a tree are its mouths, what shall we call the flowers and fruits? Answer, they are all alike the offspring of the tree. As the blessed St. Paul says, "they bear not the root, but the root them." A tree in full vigour often kills its own offspring, the

weak underling branches ; and this is called natural pruning : but the skilful pruner assists nature ; he does not wait till the branches are dead, any more than the skilful vine-grower waits till the berries are dead before he thins the bunches of grapes, &c. If fine clear timber is as desirable as fine flowers and fruits are, then pruning and thinning are necessary operations. It is natural that a tree should have leaves ; and it is natural that a sheep should have wool : the former protects its parent from the scorching summer sun, and the latter from the winter storms ; they both assist in carrying off superabundant sap, and yet may you deprive the sheep of its fleece in the middle of winter, or a tree of all its leaves in the middle of summer, if artificial means are used to protect the sheep from catching cold, and the tree from being blistered by the sun.

I have said that the branches are merely the offspring of the tree, and I add that they draw up sap only to enrich themselves. This can be proved by looking at an apple tree grafted upon a crab, or the weeping ash grafted on the common ash : they are complete bloodsuckers. I have seen a weeping ash, not quite so large as an Egyptian pyramid, but getting on that way like ; while its foster-mother was not fit for a ladder-pole : and I have seen a common ash, planted at the same time, with a top that barely makes room for three rooks' nests, yet with a trunk fit for sawing into eleven-inch planks. When a less succulent graft is introduced into a more succulent stock, the case is reversed, the stock overgrows the graft, and kills it in a few years ; on the same principle that trees kill their own offspring, in the way called natural pruning : witness the cytusus budded on the laburnum, and a thousand other examples.

I believe this system of physiology will be new to most of your readers ; but it is the true system for all that. It is a reform in the old system ; and, like the brave Earl Grey, " I will either stand or fall by the bill." I shall not, however, go the length of some, to cry " the whole bill, and nothing but the bill : " it must be mended in a committee of practical men, who know at what time to shear a sheep, and when to prune a tree ; and not by " ignorant and self-sufficient baronets," who read books, and write books, and yet do not know how to prune a currant bush. *Malheur à vous, conducteurs aveugles !* My sheet is filled up, and, of course, my article, as you call it, is long enough ; but I shall come to the *scratch* again, if I receive another call, and now remain,

Yours, in good troth,

Heath House, April, 1832.

JOHN HOWDEN.

ART. XIV. *Remarks on laying out and managing Flower-Gardens.*
By Mr. ROBERT ERRINGTON.

Sir,

I FEEL pleasure in complying with your request as to sending you some remarks on flower-gardens, and shall be glad if there should be any thing in the following observations worthy a place in your useful work. I am, however, afraid that I am not competent to do justice to the subject; and thinking it very probable that I may fall into errors in the course of what I am about to write, I can only say, that I shall feel much obliged to any of your readers who will kindly point them out.

As to situation, distance from the mansion, &c., I can say little; these matters being, of course, regulated, in a considerable degree, by the direction of the principal walk, and some other affairs, frequently of a merely local character. I would, however, if possible, place the flower-garden a little on one side of the principal walk, not far from the mansion, and yet have it so contrived as to be almost entirely concealed from both mansion and walk; for partial concealment (it will be admitted, I think) gives a zest to beauties of this kind. In such a situation, I would have it so managed as to present to the eye from the main walk, externally, a series of boldly irregular masses, having considerable breadth, and united in some degree to the scenery around by a few single trees, bushes, or smaller groups, which require, as you well observe, considerable taste in their disposal, and are frequently carried to an unpleasant extreme. They are, however, indispensable in some situations, according to Price, and other authors of acknowledged repute, as doing away with extreme distinctness, and blending the scenery.

A walk, of somewhat less width than the principal one, should embrace the parterre; and this walk, as before observed, should be well screened with handsome plantations. The masses on the outside, especially if next the park, I would plant chiefly with timber trees, having a base or undergrowth of holly, thorn, laurel, privet, &c., to be eventually insulated, or grouped on grass here and there, as taste might suggest, and forming a gradual transition to the park scenery.

The masses on the other side, or margin, of the parterre, I would have composed, for the most part, of American plants, roses, and choice flowering shrubs; and interspersed, here and there, with ornamental trees of middle height, tree roses, &c.: and here, I think, might find a place such of the herbaceous tribes as are found too high for the beds; such as

tall phloxes, asters, georginas, hollyhocks, &c., not as principals, but thinly to tower, at intervals, over the shrubs. The masses may have an undergrowth of Portugal laurel, yew, rhododendron, and other sombre-tinted evergreens, to heighten the contrast, and render the parterre somewhat striking, as well as gay. These masses should not, I think, be formed in a continuous line, but be broken at intervals, on the park side to give glimpses occasionally of picturesque views, and on the parterre side to exhibit a tempting peep or two from different positions; which breaks may serve as points of ingress and egress, and, as it were, steal in among the trees. The margin of grass between the parterre and the main walk might be so managed by planting, that the two points of junction between the main walk and the parterre walk should not be seen at the same time from any situation.

As to the interior arrangements, the margin of grass between the parterre and the side masses should, in my opinion, have considerable breadth; say, average from 10 ft. to 15 ft.; and the terminating beds should project rather irregularly on this breadth. The points of the surrounding masses, also, should be made to jut inwards occasionally, to establish a kind of connection with the parterre; allowing sufficient distinctness to the parterre as a whole, and yet doing away, as much as possible, with form for form's sake, and with detached meagreness. It appears to me that, in the style here recommended, much of the gracefulness of a parterre depends on a certain irregular breadth of grass being preserved in disposing the beds. The idea of breadth in a parterre may seem ridiculous; but when the ground appropriated to this purpose is frittered away in projecting angles, with tree roses and other plants on the grass filling up every situation where an opportunity offers, though forms may be accurate, and the ground may be well furnished, there will be little gracefulness.

For beds on gravel, I must confess, I have but very little inclination; and as to those on grass, I may here remark that the general effect does not so much depend on the precise figure of each individual bed, as on the outline and character given to the grass in the disposition of those beds. A great deal of the insipidity which is so often the subject of complaint in flower-gardens arises, I have no doubt, from that lumpishness and want of figure which the surface of the plants presents. And here I may observe, that I concur in the remarks to that effect made some time ago by Mr. Spence (Vol. VI. p. 408.), and am convinced that considerable attention must be paid to figure as well as colour. I may also add that the observations here made have reference chiefly to changeable

flower-gardens; and that a regular plan should be adopted, which would guarantee to the possessor a continual and complete succession of flowers, both in the mingled beds and in the masses, all through the season. But this, of course, cannot be effected, in the manner here represented, by a gardener who has forcing, kitchen-gardening, and shrubberies to look after, but must form a province by itself; and the man who will undertake to do justice to a flower-garden, and make it what it ought to be, will find his head and hands fully employed all the year round. Something might be here said about the division of labour in our profession; but, as old Richard says, "Folks don't preach sermons at a fair."

In the kind of garden here described, a person of good taste (except the merely scientific man) would not stop to enquire whether the number of species consisted of fifty or five hundred, provided he met with well-balanced and har-

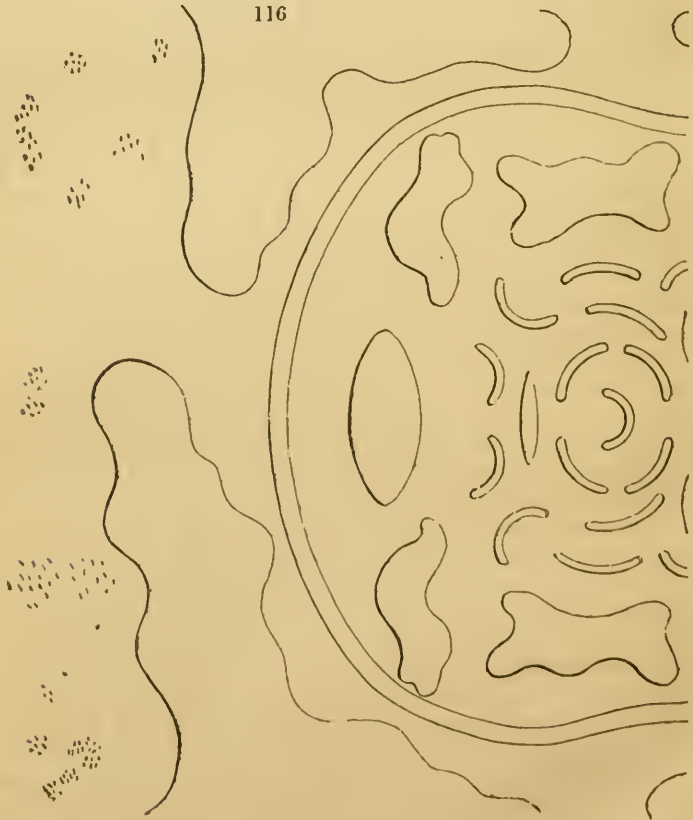

monious colours, and a beautifully playful variety of figure: to effect this, it appears to me that though, as to figure, each bed should be complete in itself; yet, both as to figure and to colour, each should bear a proper relation and subserviency to the whole. Botanical arrangements, rosaries, &c., I admire as much as any one, in their place; that is, provided we are not compelled to look upon them, and pass through them, at all times of the year: but when masses of flowers of fleeting character are made to form outlines and principal features in the scenery, I think a gaudy mass for a few weeks a sorry compensation for lumpish forms and months of barrenness.

It will be seen that the garden here described is fitted to a seat of considerable pretensions. The parterre style is, however, applicable to a place of almost any size, and, perhaps, to any circumstances, except where a connection with the buildings would impose a peculiar character on the parterre.

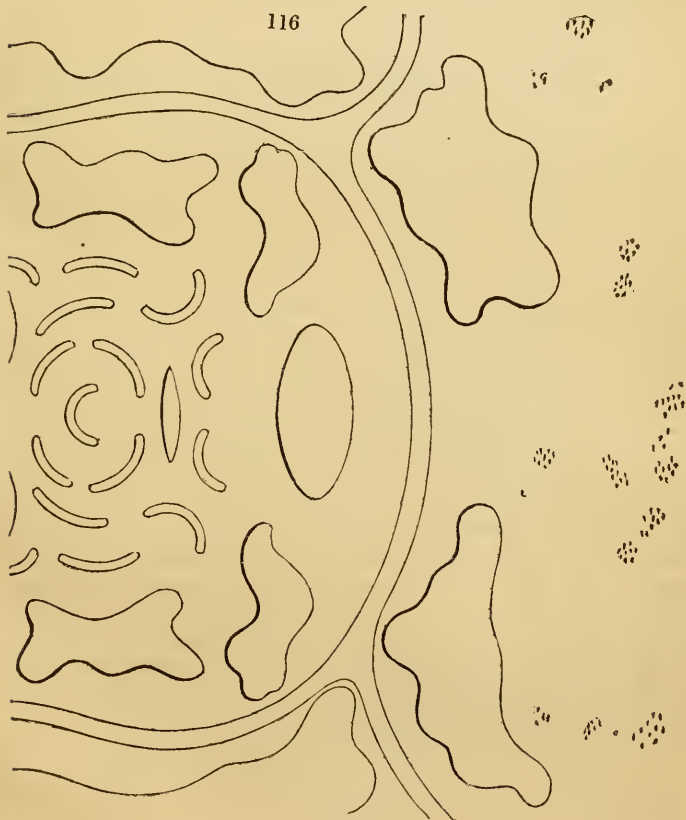

A sketch (*fig.* 116.) of the style recommended accompanies this paper. I am not aware that it has any particular title, but I suppose that it may be called the geometric wavy style. I am aware that it has no pretensions to novelty; but I think that it is not in very general use.

At some early opportunity I will add further remarks on the disposition of the colours, and the modes of accelerating and retarding certain flowers so to prolong the gaiety of the parterre.

I remain, Sir, yours, &c.

Oulton Park, Jan. 16. 1832.

ROBERT ERRINGTON.

ART. XV. *List of Exotics which are now living in the Gardens of Charles Hoare, Esq., at Luscombe, near Dawlish, in Devonshire.* Communicated by Mr. RICHARD SAUNDERS, Gardener and Planter there.

Sir,

YOUR invitation, Vol. VII. p. 722., has induced me to do what I have long contemplated doing, that is, to send you a list of exotics which are here living in the open air. It is now many years since I turned some of them out (which, you will be pleased to observe, is indicated by one of the columns in the list); consequently, they have endured several severe winters. During the severe frost of January, 1820, the thermometer here was as low as 15°; and also during the frost of January, 1830, it was as low as 12°; but notwithstanding this, and several other severe winters which these plants have endured, the greater part of them have grown most luxuriantly, and flowered abundantly. A single plant of the double white camellia had 600 flowers open on it at one time (March, 1831); and, on the 25th of March last, another plant of the double white camellia had open on it upwards of 200 flowers.

The most requisite and essential thing to be done in protecting exotics during severe frost is, to prevent any frost penetrating to their roots, by keeping them warm. Their stems and main branches should also be well protected with fine hay or dry moss, to prevent the least possibility of their juices being frozen. I very often experience the mortification of having some of the tops of their branches killed by severe frost, though this does but little injury to the health of the plants, and they very soon recover their former vigour and beauty when the fine spring weather sets in.

I am, Sir, yours, &c.

RICHARD SAUNDERS.

Luscombe, Devon, April 23. 1832.

When planted in the open Air.	Whether planted against Walls, or in the open Border.	Protection during severe Frost.	Height the Plants have attained.	Time of Flowering.
<i>Aster argophyllus</i> (Gard. Mag. vol. ii, p. 378.)	Wall, and 12 ft. from it	Coal ashes*, hay†, and mats†	12 ft.	April and June.
<i>Aloysia citrodora</i>	Borders	None. Killed to the ground in severe winters	5 to 8 ft. ann.	June to Nov.
<i>Amaryllis formosissima</i>	Near the walls	None.	-	June.
undulata	Borders	-	-	Oct. and Nov.
<i>Agapanthus umbellatus</i>	-	-	6 ft.	July and Aug.
double white	Wall and borders	Coal ashes, hay, and mats	8 ft.	-
double red	-	-	-	Dec. to June.
Middlemist's	-	-	-	March to June.
<i>Thaia viridis</i>	Border	Mat.	4 ft.	Not yet flowered.
<i>Gineraria maritima</i>	-	None.	-	Sept. to Dec.
<i>Ginnabnum Camphora</i> (Camphor tree)	Wall	Coal ashes, hay, and mats	3 ft.	May and June.
<i>Coronilla valentina</i>	Wall and border	None	16 ft.	Not yet flowered.
glauca.	-	-	8 ft.	January to Dec.
<i>Calceolaria rugosa</i>	Wall	Coal ashes and mats	3 ft.	May to Dec.
<i>Callistemon speciosus</i>	-	None	12 ft.	May to July.
<i>Bélis jaculifolia</i>	Border	Coal ashes, hay, and mats	18 in.	Not yet flowered.
<i>Daphne odorata</i>	Right angle of two walls, not trained	None	2 ft.	March and April.
<i>Eriobotrya japonica</i>	Wall	Coal ashes. Killed to the ground	16 ft.	Not yet flowered.
<i>Calamellis scabra</i>	-	None	20 to 30 ft. ann.	July to Dec.
<i>Edwardia grandiflora</i>	-	None	18 ft.	April and May.
microphylla	Border	None. Killed to the ground	7 ft.	-
<i>Fuchsia coccinea</i>	-	-	2 to 3 ft. ann.	June to Dec.
<i>gracilis</i>	-	-	4 to 7 ft. ann.	-
<i>tenella</i>	-	-	-	-
<i>Illicium floridanum</i>	Wall	Coal ashes and mats	4 ft.	May and June.
<i>parviflorum</i>	-	-	5 ft.	Not yet flowered.
<i>Zinnia trigynum</i>	Wall and border	Coal ashes and mats; but killed to ground	18 in. annually	July to Dec.
<i>Magnolia fuscata</i>	Wall	Hay and mats	10 ft.	January to Dec.
<i>Maurandya Barclayana</i>	-	Coal ashes, hay, and mats	30 to 30 ft. ann.	June to Dec.
<i>Nerium splendens</i>	-	Ditto; but killed to ground in severe winters	5 ft.	July to Nov.
<i>Olea europæa</i>	-	Coal ashes and mats	4 ft.	Not yet flowered.
americana	-	-	10 ft.	-
fragrans	-	-	11 ft.	-
<i>Pittosporum Tobira</i>	-	-	-	April to Dec.
<i>Richardia (Cállea) æthiópica</i>	Border	Coal ashes; but killed to the ground	4 ft. annually	July and Aug.
				July to Dec.

* The coal ashes are laid 6 in. thick on the surface of the ground, as far as the roots of the plant extend.

† The hay is placed about the stem and main branches, to prevent the juices from freezing.

‡ The mats are fixed over the plants, and, in severe frost, a double matting is given. When the plants are large and bushy, pieces of wood are first placed in a sloping direction against the wall, to which the mats are nailed.

ART. XVI. *List of certain Green-house and Hot-house Plants which have stood out during one or more Winters, in the open Air, in the Garden of Robert Mallet, Esq., at Drumcondra, near Dublin.* Communicated by Mr. MALLET, Jun.

Sir,

I SEND you a list of some plants which stand out with me, at Drumcondra, near Dublin. Those marked with an asterisk have been out for two years or more, the others only one.

Aquatics.

- **Richardia* (Cálla) *æthiópica*. In water, 2 ft. deep; out three years; flowers every year. *Aponogëton distàchyon*. In a vase. *monostàchyon*. In a vase.
 **Jussiaëna speciôsa*. A hot-house perennial, in an open pond; has not shown flower. **Sagittària lanceolàta*. In an open pond; flowers every year.

Plants not on the Wall; that is, Standards or Herbaceous.

- Yucca serrulàta*. *Bambusa arundinàcea*. Growing in *aloifolia*. peat and pond mud, 7 ft. high.
 **Melia Azedarách*. **Pæonia Moútan*, var. *papaveràcea*.
 **Fúchsia*. All the species, except *Acàcia lophántha*.
arboréscens, which I have tried several times, and have never been able to get to stand: I had one large specimen killed by even the last mild winter. *Lycopòdium dènsum*. On rock-work.
Mesembryánthemum. 97 species, on rockwork, with some species of *Crássula*, *Agàve*, *Cotylèdon*, &c. **Tradescántia crassifolia*.
Sempervívum arbòreum. On rock-work. **Agapánthus umbellàtus*.
 **Solànum bonariéscens*. **Echium cándicans*.
 **Opúntia Ficus indica*. On rock-work. *formòsum*.
Brigmánsia suavèolens. Vigorous; watered with dung water occasionally.
Justícia Adhátoda.
 **Verónica decussàta*.
Davállia canariéscens. On rock-work; the soil peat; grows vigorously.

On a Southern Aspect.

- **Corræa álba*. **Dáplne odòra*.
Canéllia japónica var. *myrtifolia*. *Rúseus andrógynus*.
 Sickly; the situation damp. **Púnica Granàtum*, &c.
 **Schinus Mòlle*. **Eriobótريا japónica*.
Polýgala latifolia. *Maurándya Barcelayàna*.
Meliánthus cocéneus. A new species from the Cape. *antirrhiniflòra*.
Asclépias [*Gomphocárpus*] *arboréscens*. *semperflòrens*. These maurandyas require a dry situation, and to be covered with sand, or turf mould, in winter.
Acàcia salicifolia. *Lophospérmum erubéscens*.
 **decúrrens* (var. *gláuca*.) **Mýrtus romàna*, and most of the common varieties.
lophántha. **Passiflòra cærúlea*. Covers above
 **Lagerstræmia indica*. 1200 sq. ft.
Táxus elongàta. **cærúlea racemòsa*.
Sophòra tomentòsa. **cærúlea alàta*.
 **Olea europæa*. With *Cúscuta nivaléscis* on it, which flowered abundantly last July and August. **Colvilli*.

**Passiflora chinensis*. All these species flower well out, and need but little protection during winter.

P. edulis. Now in flower, with fruit set; grown from a layer of last year. Layers of the *Passiflora edulis*, planted early in spring, on a south wall, will afford a nearly constant supply of its grateful fruit during the year; and will save the very great room which a single fruiting plant of it takes up in a house.

**Melaleuca linearis*.

**hypericifolia*.

lanceolata.

Dolichos lignosus.

**Lonicera chinensis*.

**Lonicera flava*.

americana.

**Pelargonium peltatum*, 6 ft. high.

I have sixty species and varieties of pelargoniums; large plants planted out, which I intend to remain to take their chance for next winter, as many such stood out uninjured in Livingston's nursery, at the south of Dublin, and also at the Trinity College garden, last year.

Citrus Aurantium. From seed; sickly.

Wistaria Consequana.

**Cissus antarctica*. A most desirable climber, in a fine aspect.

On an Eastern Aspect.

**Aster argophyllus*, 12 ft. high.

**Clématis calycina*.

**aristata*.

**Artemisia ramosa*.

Málva capensis.

**Euphòrbia mellifera*.

**Leonòtis Leonurus*.

**Ceanòthus africanus*.

Globulària longifolia.

Colùtea frutescens.

Royèna hirsuta.

**Cnpréssus péndula*.

**Sálvia africana*.

**Céstrum Párqui*.

**Pittósporum Tobira*.

Thèa Bohèa.

**viridis*.

**Rùbus rosæfolius*.

Pistàcia atlántica.

**Calámpelis scabra*.

**Lavándula dentata*.

**Tarchonánthus camphoratus*.

Convólulus linearis.

Péntzia flabellifórmis.

Cluýtia pulchélla.

**Jasminum revolútum*.

**Aloýsia citriodora*.

The garden in which these plants are growing is one mile north of Dublin; its surface is about twenty-five feet above the level of the sea, and it slopes gradually to the south, with an inclination of about one in twenty. All the above plants, with the exceptions of the *Caméllia* and *Citrus*, are in good health. The roots of all are covered about six inches in depth with light dry turf mould in winter; which, after very wet weather, is removed, and dry substituted. Some of the more tender are protected by mats, but most are left exposed the whole winter. The mesembryanthemums are on a rockwork, with the interstices filled with pebbles and a little earth, and are growing luxuriantly. Most of them were in full flower about a month since.

I am, Sir, yours, &c.

Dublin, August 6. 1832.

ROBERT MALLET.

ART. XVII. *On sowing annual Flower Seeds in the Autumn, in order to have them flower early in the Spring.* By R. T.

Sir,

PERMIT me, through the medium of your pages, to call the attention of gardeners to the sowing of annual flower seeds in the autumn, in order to have them flower early in the spring. The superiority of autumn-sown lettuces and cauliflowers is already well known, but not so (generally speaking) that of annual flowers. Notwithstanding, the latter is equally as worthy of attention as the former. I have followed the practice for several years, and have since read of it; but I never saw it till I began it myself, though I do not presume to think but that some others had done it before, though they did not give it the publicity it deserved. My method is this:—About the middle of September I sow such sorts as I desire, for instance, *Schizánthus pinnátus* and *pórrigens*, *Coreópsis tinctoria*, China aster, *Málope trífida*, *Gília capitata*, *Commelina cœléstis*, *Delphínium sinéense*, Spanish pink, *Clárkia pulchella*, *Hibíscus africànus*, *Verbèna Aublètia*, with many others, in pots in the open ground, or in a cold frame, and, when large enough, I prick them into other pots. If only to plant out in spring, a few in a 32-pot of each sort is sufficient. On the appearance of damp weather, I put them into a frame, and give all the air I can, without exposing them to the fogs or rains. If I am afraid of severe weather, such as I cannot keep out of the frame without too much covering, I remove them to an airy part of the green-house, where they remain till the beginning of March, at which time (if they have become too thick in the pots) I shift them singly into 60s, ready to plant out as soon as the weather is mild enough. When this is the case, I plant one in each place. I find that they will flower in far greater perfection than any sown afterwards in the ground, and in some sorts full two months sooner. If I have more plants than I want for the flower-garden, I shift a few into 48s, and put them into some of the forcing-houses, where they soon flower, and make a very pretty appearance at so early a period as to allow me to have some plants of *Schizánthus pinnátus* and *pórrigens* in bloom for the last month, and others are just coming into flower to succeed them.

May 3. 1832.

I am, Sir, yours, &c. R. T.

ART. XVIII. *On the Culture of the Ranunculus.* By A VILLAGE SCHOOLMASTER.

Sir,

I AM a lover of floriculture, and have read the communications of Messrs. Tyso and Thompson on the culture of the

Turkish ranunculus, in your Magazine, with great pleasure. The former writer's plan is an excellent one for procuring seed, as the experience of the last growing season enables me to testify; having pursued it, and having now fine healthy pericarps from varieties from which I never before succeeded in obtaining a single seed. What sort of flowers these seeds will produce, I hope to be able to tell you by this time next year. You will think that very soon; but I mean to treat them in the same way I procured flowers this June, from seed sown last October. Some time early in October, 1831, a head of seed, from a tolerably thickly petaled light semi-double ranunculus, was sown in a square pan of twelve-inch sides by four deep; at each corner was a pipe luted to the sides, open at top and bottom, for the purpose of watering the earth, without disturbing the seeds, or allowing a crust to form on the surface, through frequent watering from a water-pot rose in the usual way. In the middle was a hole for allowing the superfluous water to drain away. About a fortnight or so after sowing, the seeds came up (here I should state the pan was put into a cucumber frame, with a couple of seed cucumbers only on the vines, and no heat but that afforded by the solar rays): as soon as they had vegetated, the glasses were kept close, in order to take the advantage of the heat of the sun, to force them as much as possible. By the end of November they were an inch high, and I removed them into a room facing the south, in which a fire and warm air stove were kept for about six hours each day. There they drew towards the light, and began to get of a sickly yellow by the beginning of February. On Valentine's day I made my cucumber hill, and a week afterwards, when the heat was well up, I put my pan into it. The seedlings recovered immediately, grew away vigorously, and threw up strong flower stems at the end of April. I then removed them, and placed them against a south-east wall in the open air, in which situation they have flowered, and are at this moment loaded with strong healthy heads of seed. The plan is nothing more than an extension of Mr. Sweet's plan of flowering tulips unusually quickly, extended to another tribe of florist's flowers. I have been equally successful with pinks, although not precisely in the same mode.

A VILLAGE SCHOOLMASTER.

*London (being now in town),
July 30. 1832.*

ART. XIX. *On the Cultivation of Ranunculus parnassifolius and Oxalis floribunda.* By Mr. JOHN MENZIES, Gardener to Christopher Rawson, Esq., Hope House, near Halifax.

Sir,

RANUNCULUS parnassifolius of your *Hortus Britannicus*, p. 230., was introduced in 1769, and is now very rarely met with, on account of the difficulty of preserving it from the attacks of snails and slugs in the spring months. I have for the last four years used (for the preservation of this rare and beautiful plant) a pot or snail trap (*fig. 117.*), of the same composition as a common garden pot, all in one piece. The trap is 14 in. in diameter, and 6 in. deep; the plant is planted inside, at *a*, which is without bottom, and allows the roots to penetrate through. The division *b* is joined at the bottom without any holes, merely for holding water. The trap is then sunk nearly on a level with the surface of the ground, in a situation where it is shaded from the midday sun: the water effectually prevents either snails or slugs reaching the plant. The soil used is equal parts of hazelly loam, vegetable mould, and bog earth, in which the plant grows luxuriantly, throwing up flower stems from 10 to 12 in. high. It is propagated by seeds. The trap should be covered in winter with leaves,

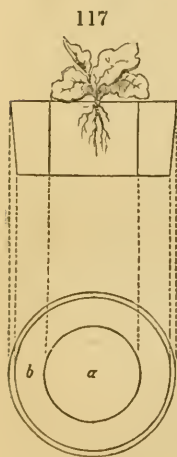

to prevent its being broken by the frost. In the bed with the *Ranunculus* I have grown *pyrolas*, *cypripediums*, *trilliums*, *Panax trifolia*, *Trientalis europæa* and *americana*, *Rubus pistillatus*, *arcticus*, and *Chamaemorus*; *Soldanella alpina*, *Clusii*, *minima*, and *montana*; *Anemone alpina*, *pätens*, *acutipétala*, *Halleri*, *vernalis*, and *narcissiflora*: and I have planted, in a little frame near it, *Epigæa repens*, *Polygala paucifolia*, *Rhododendron Chamæcistus* and *lapponicum*, *Andróméda tetragona*, *Anthyllis erinacea*, *Parnassia caroliniana* and *asarifolia*, *Thalictrum anemonoides*, *Thalictrum anemonoides flore pleno*, *Gentiana verna*, *alpina*, and *Saponaria alba*; *Jeffersonia diphylla*, and *Soldanella minima alba*.

Oxalis floribunda *Hort. Brit.*, p. 185. [*rösea* *Add. Sup.* p. 595.] was introduced in 1826 from South America. This plant has a singular fleshy root, quite different from the other species of the same genus; and, as it possesses extraordinary beauty when in flower, perhaps the following mode of culture may be worthy the attention of some of your readers:—On an

examination of the root of a good plant, many growing buds will be perceived: in the month of February I take off two or three of these buds, with part of the fleshy root, according to the size of the plant; I then insert them in the common way, in sand, under a bell glass, give them a little water, and place them in the front of the stove, where they can have as much light as possible. As there is no occasion to shade them, in ten days they are ready to pot. I water the cutting pot, and turn them out; putting only one plant in a pot, in a mixture of vegetable mould and peat earth. After potting I give them water, and place them in a shady part of the house till I perceive the heart leaves growing; afterwards I expose them in the light. In March they are removed to the greenhouse, where they can have plenty of air; in May they are turned out on a border where I grow the Ghent azalea, *Azàlea ledifòlia*, rhododendrons, kalmias, ledums, andromedas, *Gaulthèria Shàllon*, and North American azaleas, and where the *Oxalis* flourishes, showing a profusion of red flowers till October, when I pot the plants, and place them in the greenhouse until the following year. I remain, Sir, yours, &c.

Hope House, near Halifax,

JOHN MENZIES.

January 24. 1832.

De Candolle states (*Regn. Veg. Syst. Nat.* i. p. 244.) that *Ranúnculus parnássifòlius* L. inhabits the rocks of the Alps and Pyrenees at the point contiguous to eternal snow, and that there it flowers in summer: these facts may further hint the plant's requirements under artificial culture. — J. D.

ART. XX. *On the Culture of the Heartsease Violet.* By Mr. ARCHIBALD GORRIE, F.H.S. and C.H.S., &c.

Sir,

SOME seven or eight years since, I was presented with two violets by a respected friend* (on his leaving this part of the country), with an injunction that I should pay attention to their culture. From respect to my friend, attention to my beautiful charge became a pleasant duty; and any little care I bestowed has been amply repaid by a profuse and beautiful variety of that lowly and charming tribe of plants. Having obtained what were reckoned some good varieties, I distributed them among several of my professional brethren, which answered two purposes I had in view: the first, to

* Mr. Brown, late of the Kinnoul nurseries.

oblige my friends; and the second, to promote a taste for my favourite flower. I also used my influence with the Perthshire Horticultural Society to get it introduced into their schedule as a prize article; and the consequence is, that this spring and autumn flower is, in this quarter, now meeting with merited attention.

One of my original breeders, which is called Brown's Violet, is a fine improved variety of *Viola tricolor*; upper and side petals deep purple tinged with carmine; lower petal brown, with a slight yellow laced border; eye yellow, permanent, and well marked; average length of flower, an inch and three tenths; breadth, an inch and one tenth. This favourite is difficult to preserve, it being a sort of biennial; but its existence may be prolonged by cuttings or layers. Its seedlings maintain a near family likeness. The flowers have generally a sweet smell.

My other original breeder was the *Viola grandiflora*, of which I still retain the original plant by cuttings. It does not seed very freely, and its seedlings are liable to sport. An improved variety has been obtained with the parental colours, but a more regular flower, and rather larger than its parent: it forms almost a circle of nearly two inches diameter. Its upper petals are purple; side and lower petals light blue tinged with purple; eye small, yellow, and permanently distinct. From this I very early obtained a beautiful large flower, which a friend, to whom I gave the first plant I had to spare, out of compliment named Gorrie's Superb. From this many beautiful seedling varieties have been produced. The upper petals are a fine dark velvety purple; side and lower petals deep ultramarine blue; the two side petals deeply shaded above the eye, which is light orange, in the centre radiate, and the rays light yellow at the extremities. The flower measures, at an average, two inches and two tenths every way. The original plant is still preserved, and very extensively distributed; from it has been produced here, last season, Queen Adelaide, named (without asking permission) as an expression of loyalty. It is something like the former in its upper petals; the others have the blue brighter, the shades deeper, the eye more compact, and altogether it is reckoned a finer flower than my Superb. Another, raised at the same time, and from the same original, is called Miss Drummond: it has a strong resemblance to the Superb, but all its petals are of a deeper velvet purple, the eye is yellow, radiate, surrounded by a marked light blue halo: it is longer-shaped, and rather less, than Queen Adelaide. One named Lady Murray Threipland, is a beautiful

mazarine blue, tinged with purple, approaching to a self; the eye something like the Superb in form, but the side and lower petals are in better proportion with those above; the colour of the eye is light yellow. Of the selfs, or one-coloured, these have been named:—Robina, with all the petals light blue, something waved, eye yellow or gold colour, finely radiate, and flower large; Miss Neil, petals bright purple, eye small, orange-coloured, finely radiate, flower much longer than broad; Miss Paul, petal similarly coloured with the above, eye larger, bright yellow, radiate. Of several fine white flowers, the only one yet named here, besides the old *altàica*, the parent, is the "*Belle Blanche*:" it was raised by Robert Bell, a shoemaker in Rait village. The flower measures in length two inches, and in breadth one inch and three fourths. The eye is yellow, marked above with two deeply coloured blue spots. A beautifully shaped cream-coloured flower has appeared this season; it has the honour of being named, by request, Jesse. The eye is a gold colour, radiate, with black pencilled lines in every direction. A very large and beautiful purple self, with a bright eye, is named Catherine of Gowrie; it is larger than the old *grandiflora*; another, with dark waved petals, is named Eliza. These three should stand together in a collection. The *Duffiana* is a fine black dingy violet, raised by the village dominie, Mr. Duff. Pemie's Highland Mountain is a large, pale, yellow hybrid, between the *altàica* and *lùtea*. Gorrie's Incomparable is one of the finest yellows yet seen in this country. Such are a few of those already reckoned worthy of being named: new and beautiful varieties are daily being produced, which repay the cultivator in a very short space from the time of sowing. Violets flower here from the middle of April till the middle of June, when the sun's heat becomes too strong for them; they commence again about the middle of August, and continue to display their brilliant hues till prevented by the frost. They delight in a rich and highly manured soil. The properties of a good violet are reckoned to be, large and round petals, the flower forming nearly a circle, not much undulated; colours distinct and permanent; eye rather small, and not deeply pencilled; flower-stalk strong and straight; and the stigma filling the open part of the eye.

I am, Sir, yours, &c.

ARCHIBALD GORRIE.

Annat Gardens, June 11. 1832.

ART. XXI. *On the Culture of the Pine-apple without Pots.* By Mr. JAMES MITCHINSON, Gardener at Pendarves.

Sir,

HAVING seen an account of the culture of the pine-apple without pots in the Royal Kitchen-gardens at Nymphenburg, by Mr. Joseph Lang, in the Gardener's Magazine, Vol. V., p. 427., I felt determined to make a similar trial; and, about fourteen months since, having three lights of our pine-pit at liberty, I had it filled with oak leaves to a sufficient height. These having been well trodden down, and made perfectly level, I had a little earth put along the back of the pit where the first row of plants was to stand; I then turned some succession plants out of their pots, and, placing them in a row behind, filled the spaces between them with earth, keeping it as light as possible; I also put it in rather rough, that the roots of the plants might run more freely through it. When one row was planted, I proceeded as before, till three rows were in, which filled the pit, it being only 6 ft. wide inside. I then gave a gentle sprinkling with water, to wash off the dirt from the plants, and settle the earth a little. In about a fortnight I found the plants begin to grow rather strong, which they continued to do, and in the course of the summer most of them showed fruit; and, although I had some plants in pots much larger than they were, the fruit from these was finer and much higher flavoured. One plant, a Jamaica pine, which did not show fruit till late in the summer, ripened this spring a fruit $4\frac{1}{4}$ lbs.; and, although ripe about a fortnight, it obtained an extra-prize at the first exhibition of the Royal Cornwall Horticultural Society at Truro, June 29. 1832. I have now three Montserrats and a queen in fruit in the same pit, that were put out as above, fourteen months since, which are now looking extremely well, and seem likely to be both large and handsome: in fact, so great was the satisfaction I experienced from the experiment, that this spring I planted, in the same manner, the whole length of our pit, being 70 ft. long and 6 ft. wide; and, as before stated, containing three rows of plants. I am extremely glad to be able to say that these newly planted pines are doing equally well, and that many gardeners, as well as gentlemen, who have seen them, say they never saw finer plants or finer fruit; for my own part, I can only say I am not ashamed to show them.

In winter, autumn, and spring, we use hot water to obtain the requisite degree of heat for keeping the plants in a healthy state. I also use a lining of hot dung in front of the pit (it

being placed on arches), when occasion requires it. I find the hot-water system to answer extremely well, better than any other method I have ever seen in use.

I grow our succession and nursery plants in a pit built of bricks, pigeon-holed; and I use linings of dung, leaves, grass, &c., when the heat of the bed in the inside requires renewing. The plants are kept in pots till wanted for plunging out for fruiting.

The saving of trouble and expense occasioned by the above treatment of the pine-apple will, I trust, be evident to all your readers; and I hope many of them will not only take my word for its being attended with complete success, but that they will give it a fair and similar trial to that I have endeavoured to state above: if they do, I fancy the result will be, that some will find that pine-apples will grow, and that freely, with scarcely any bottom heat, particularly when out of pots.

If you should consider this worthy of insertion in your Magazine, it is at your service; and, I assure you, no one will be more anxious to hear of similar experiments being made, and found to answer, than myself; and also that, through your Magazine, a fruit so desirable may, ere long, become more generally cultivated than at present.

I am, Sir, yours, &c.

Pendarves, July 31. 1832.

JAMES MITCHINSON.

ART. XXII. *On a rapid Mode of raising excellent Vine Plants.*
By Mr. T. RUTGER, Gardener at Short Grove, Essex.

Sir,

THE following is a mode by which I raised a sufficient number of fine young vines to stock a vinery:—

At the pruning season, leave a shoot of strong young wood, over and above what may be wanted for training, of a sufficient length to bend down to any convenient place where a pot can be placed to receive it as a layer; and also for training it during its growth. When the vine begins to push, displace all the buds from the shoot intended for laying, except the leading one. When this is grown to about 8 in. or 1 ft. in length, bend it down to the pot, and lay it so that the top joint, whence the young wood has sprung, may be fixed with a strong crook at about 1 in. under the surface of the mould. As soon as it begins to take root, which may be known by removing a little of the earth, begin to weaken its resources

from the mother plant, by making an incision in the wood behind the pot; which enlarge by degrees, as fast as the young plant will bear it, until it be quite separated from the old one.

The advantage of the above method is, that the vine may be grown to 10 ft. or 20 ft. and upwards in length the first season, with a pot full of roots; so that it may be planted in any situation where it may be wanted, without being checked in its growth, as is generally the case when grown in the usual way from a layer.

The pot ought not to be less than a 24: it must be filled with rich compost; and, if the layer be watered occasionally with liquid manure, it will considerably promote its growth.

I am, Sir, yours, &c.

Short Grove, Essex, July, 1832.

T. RUTGER.

ART. XXIII. *On substituting good Vines, either as to Kind or State of Health, for bad ones, with the least possible Loss of Time.*

By Mr. ALEXANDER GORDON, late Gardener to Sir F. G. Fowke, Bart., Lowesby Hall, Leicestershire.

Sir,

THERE are various causes which have a very injurious tendency, with respect to the growth of the vine in this country; but the most general is some defect in the formation of the border in which the vines are planted, which often goes a great way towards annihilating their existence. Partial remedies are frequently attempted, but they are merely competent to prolong a sickly existence; seldom, if ever, effecting a radical cure. When vines become sickly, I would most strongly recommend a complete renovation of the border, extirpating the old vines *in toto*, and planting young ones. That this may be done with the least possible injury to the dessert, and that it may receive a speedy supply from a newly built house, I have adopted the system of which I send you an account below.

If an old house and the vines in it do not give satisfaction, they may be forced early, and the crops cut in April and May; by which time good plants can have been raised from eyes propagated in the month of February. A sufficient quantity of proper compost must also be in readiness. Then destroy the old vines as soon as all the fruit is cut; prepare the border in a proper manner, giving due attention to a proper drainage; and in a few days after all is completed, if the weather is favourable, the vines may be planted: they will

each produce an excellent shoot the same season. Instead of cutting this shoot back the following spring, as generally done, it is to be left 15 ft. or 20 ft. long, and trained as exhibited in the accompanying sketch (*fig. 118.*), which is a section

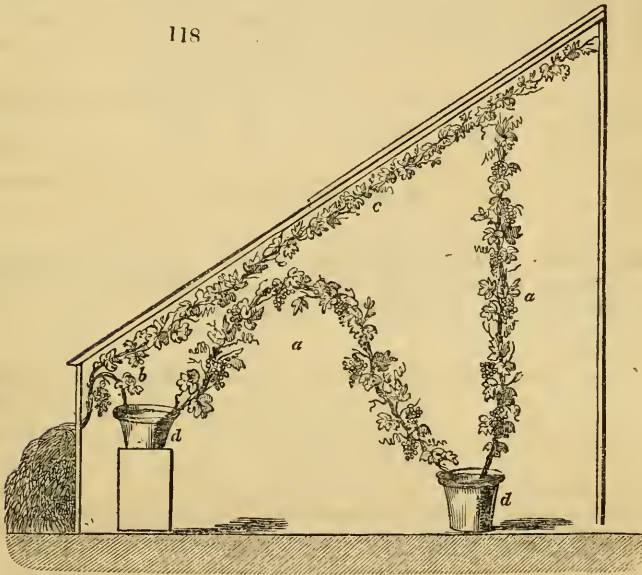

of a house now under my charge, with the present and future bearing wood as it now exists. *aa* represents the shoot of the first season trained into its present form in the month of February last; having been first twisted at *b*, and again when introduced into the pots *dd*. The twist at *b* produces the emission of the shoot *c*, from the eye immediately under the twist at *b*. The pots (*dd*) ought to be filled with rich compost, as it is from this source that the shoot *aa* will receive its principal support, by an abundant supply of liquid manure while the vines are in a growing state. The vine *c* is intended as the principal or permanent shoot; *aa* being completely separated from the plant when the fruit is cut. By these means we do not lose a single crop. The house is replenished with young healthy vines, and the border is in a good condition to produce abundant crops. As a proof of this, I may mention that the vine *aa* is a Black Hamburgh, propagated from an eye, in February, 1828; planted in May of the same year, in a newly built house; and now bearing thirty-five excellent bunches of grapes.

In conclusion, I beg leave to state that the vines were

reared, planted, and managed by my predecessor, Mr. Cadness (whom I would be sorry to deprive of the merits due to his good management), until eight weeks ago; consequently, my only motive in this communication is a sincere desire to disseminate any useful information which comes under my observation, being perfectly indifferent whether the credit be due to myself or others as it respects its origin.

I am, Sir, yours, &c.

ALEXANDER GORDON.

Lowesby Hall, Leicestershire, Aug. 28. 1829.

ART. XXIV. *On the Destruction of the Aphis on Peach and Nectarine Trees.* By Mr. G. JAMIESON, late Gardener to Mrs. Bulwer Lytton, of Knebworth Park, Herts.

Sir,

THE peach and nectarine trees, when planted against walls having a south or south-east aspect, come into flower in the end of March, or the beginning of April; and in ten or twelve days afterwards they come into leaf. About this season we have generally cold dry winds from the north or north-east; and after these have prevailed a few days, the aphis commonly makes its appearance.

As I have been very successful in the destruction of this pest of gardeners, it may, perhaps, be of some use to state my practice.

In the first place, water the tree over-head with a syringe or garden-engine; then put a quantity of gas tar into a flower-pot or any open-mouthed vessel; place it as near the tree as you can, without incurring the risk of the heat of the process to be described injuring the leaves. Then put into the vessel as many burning coals as will set the gas tar on fire; and in a few minutes a dense cloud of black fetid smoke will rise up, and, in a mild day, completely envelope the leaves of the trees. If the day be not mild, you must carry on the operation either under a temporary covering of mats, or wait till the wind blows either against the wall, or in the direction of it. The evening or the morning is the best season for this process; a very few minutes will suffice for each tree; and, as soon as the fumigation is over, the trees should be syringed, to wash off the soot and the dead insects.

I am, Sir, yours, &c.

G. JAMIESON.

6. Sale Street, Edgware Road, London, Aug. 1. 1832.

MR. JAMIESON, we understand, practised this method at Knebworth with the greatest success; and he has no doubt that it might be employed in orchards on a large scale, instead of the present practice of burning straw. In North America there are, in some seasons, immense flights of locusts, of some miles in length, and a mile or more in breadth. Might not a whole country unite in burning gas tar at the same moment, so as to destroy these insects *en masse*? There would be no danger to human beings who were content to keep close to the earth; because, all smoke being lighter than pure air, the latter would naturally gravitate to the surface. Considerable annoyance to an army entering a town, or to ships at sea, the wind being in a favourable direction, might, no doubt, be effected by the skilful management of so powerful a smoke; produced in such immense quantities, and so rapidly, from such a small quantity of materials. In the cities of Russia, it is the custom to disperse mobs, and quiet drunken people, by playing water on them with a fire-engine: in desperate cases, perhaps, smoke would be preferable. For garden purposes, it would be very desirable to know the neatest, cheapest, and most commodious mode of generating and applying this smoke. Probably dry leaves of trees, or coarse paper, or tanners' bark, impregnated with gas tar, might be burned in a fumigator such as we have figured in p. 354.; and thus this seemingly clumsy process might be rendered as easy of use, and neat in application, as the process of fumigating with tobacco. We recommend the subject to the attention of our readers, and especially such of our young friends as have studied a little chemistry. — *Cond.*

ART. XXV. *Account of a Method of gathering Apples from the most lofty and slender Trees, without breaking any Twigs, and without Danger to the Operator.* By Mr. E. M. MATHER.

PROCURE a ladder of the requisite length, and two cords, about twice as long as the ladder, with a noose at each end; also two iron pins, 3 ft. long, pointed at one end, and furnished with a round flat head at the other. Place the end of one of the lines under the top stave of the ladder, and slip it over the end or top of the ladder side. The same being done with the other line, spread both of them out to the right and left, and fasten them to the ground by means of the two

119

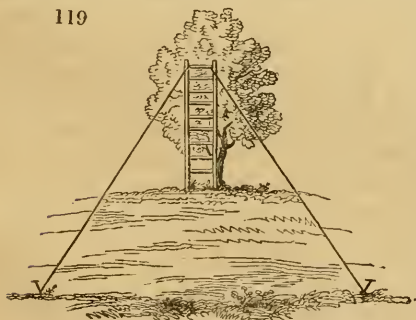

pins before mentioned; taking care to push the pins so firmly into the ground as to support a man and ladder, without its leaning against the tree. I will endeavour, by the following rough sketch (*fig. 119.*), to illustrate my meaning. Care must be taken, in setting the ladder, that

each rope has an equal bearing, so as that the ladder may stand secure; and the more perpendicularly the ladder is placed the better. The ropes need not be thicker than common sash cord; and the reason why I place them under the top stave of the ladder, and slip them over the top end, is, that they may not pull out the sides of the ladder, which they otherwise would do. -

I remain, Sir, yours, &c.

Old Baseford, Feb. 24. 1830.

E. M. MATHER.

[See Mr. Saul's device for effecting the same object, Vol. VII. p. 26. — J. D.]

ART. XXVI. *On the Fruits used in the Manufacture of Perry and Cider.* By J. C. K.

Sir,

ALLOW me to be the means of correcting an error, which, having originated with Mr. Knight, has now been transferred by Mr. Lindley to his work on *The Orchard and Kitchen-Garden*; and which, emanating, in the first instance, from so great an authority, has obtained a credence to which it appears it is in nowise entitled. In the article on the Barland pear (*Lindley's Guide*, &c., p. 414.), there occurs the following passage: — "It (i. e. the perry) may be mixed in considerable quantity with new port, without its taste becoming perceptible. It sells well whilst new to the merchants; and, as it is comparatively cheap, it probably forms one of the ingredients employed in the adulteration of this wine." Now, it is possible that it would not be easy to detect, by the taste, the admixture of a portion of the juice of this pear; but it would infallibly excite fermentation in the wine, and very speedily convert it into vinegar. The Barland perry is even more likely to do this than any other: for it is a notorious fact, that the cider merchants rarely, if ever, purchase it; because, though early in the season it is a very good perry, or even afterwards if not moved, yet it is so liable to the acetous fermentation as to entirely unfit it for transmission to long distances. The passage above quoted does not specify whether wine or cider merchants are intended: but it cannot mean the former; for how are wine merchants, living at a distance, to obtain, while new, a liquor which immediately on its expression from the fruit requires the greatest attention; and which, if sent only a few miles, would inevitably, from its active fermentation, burst the vessels that contained it, if they were closed? It is only fit, after being duly fer-

mented and clarified, for removal in the following spring; at which time, and at which time alone, the cider merchants send off large quantities to all parts of the kingdom; nor is any quantity sent to a distance, which does not pass through their hands. The Oldfield perry is almost the only sort purchased by the cider merchants to any extent, to the exclusion of all others, except the Teinton squash, and meadow pear, of which but small quantities can be obtained. In scarce seasons the cider merchants are occasionally induced to take a few hogsheads of Longland, Bache's white, and Huffcap, which are usually designated indiscriminately as perry, and not, as is the case with the others, specifically named, and which do not bear comparatively so high a price. The meadow pear is a sort only within these ten years brought into cultivation to any extent, and the squash is nearly worn out.

This observation brings me to another remark of Mr. Lindley's, wherein he combats the idea that the golden pippin is incapable of being longer continued in cultivation. He adduces facts in support of his position, and on facts alone shall my arguments against it be founded. Know, then, that, notwithstanding the continual efforts, varied in every conceivable manner, exerted by many from their desire to retain this valuable fruit, the quantity thereof yearly diminishes. On one estate (Sir J. Cotterell's, in Herefordshire), where formerly eight or ten hogsheads of this cider were made in an average season, there are not now gathered sufficient to supply the dessert table; and the same is universally true. I can only learn of one house in the trade, which has been able to purchase any golden pippin cider within these twenty years, and that quantity was only sixty gallons, and at four times the former current price. Within the memory of some individuals, golden pippins were so plentiful that they were ground up promiscuously with the other fruit, while now they are all carefully gathered to supply Covent Garden and the other markets of which Mr. Lindley makes mention. Then, the golden pippin tree needed no "warm or sheltered situation," and no protection from the "cold blasts." The old trees, in some instances, yield good crops; but they are continually dying off, and great difficulty is encountered in rearing young trees, which canker and dwindle after a few years' growth. One gentleman (the former rector of Kemerton), on a favourable soil, after trying every other means, was only partially successful in obtaining fruit on a wall. Mr. Lindley states that the golden pippins will keep two months; I have eaten them in high perfection in the May of the year following that in which they ripened.

I perfectly coincide in your opinion of the want of more numerous synonymes when well established. I can find no mention either of the Chaseley Harvey, which I consider the most delicious apple we possess, or of the Flanders pippin, or Moll Flanders, which, as a culinary and useful apple, even for the table, stands here the first on the list, though unfortunately there is reason to fear that it too is fast following the golden pippin.

Mr. Lindley recommends, for the preservation of apples, the packing of them in sand. As far as appearance goes, this method is unexceptionable; but between fruit preserved in this fashion, and that which has merely been laid singly on and under dry straw, and covered during frost with old carpets, &c., there can be no comparison; the latter, though not either quite so plump or so sleek, being infinitely superior to the other, both in flavour and firmness.

Yours, &c.

J. C. K.

Levant Lodge, near Worcester, Feb. 20. 1832.

ART. XXVII. *On Bishop's Dwarf Pea, as compared with other early Peas.* By Mr. ANTHONY ADAMSON, in a Letter to Mr. John Gibson. Communicated by Mr. GIBSON.

Sir,

I RETURN you, with this, one quart and three quarters of Bishop's early dwarf peas. They have been saved from the sowings of those I received from you upon experiment, and for which I feel much obliged. I think it due to you, to send you the result of the experience which I have had in comparing Bishop's pea with other varieties mentioned below, all of which were sown on the same day, viz., the 5th of April, 1831. Bishop's pea came into full pod on the 2d of July, i. e., in 88 days; the early frame in 140 days; Knight's dwarf marrow in 146 days; and the Spanish dwarf in 150 days. Thus there was a space of 53 days in favour of Bishop's pea over every other variety, even the early frame. The produce of Bishop's pea is fully double that of the frame, and quite equal in flavour when taken early: the pods are short, but abundantly numerous; and, being dwarfs, their blossoms form a most elegant border. The seed from them is most easily saved, even from sowings made on the 4th of June. They require only short sticks, about one foot from the ground; as an early variety, they are of first-rate excellence. This pea was raised originally from an impregnated blossom of the Spanish dwarf. By the way, the Spanish dwarf is an excellent pea, but not early; and, if compared with

Knight's dwarf marrow, sinks into insignificance. There was never such a pea for the marrow flavour known before, as Knight's marrow. Its faults are, its not being early, and the great difficulty of saving its seed in this climate; besides, it cannot be prudently sown early, because of its tenderness of stalks. It is, however, of inestimable value, and might do well if raised in a moderate hot-bed, and transplanted as soon as the frosts were over; or if it were protected with straw ropes, or thick spray pea sticks. Knight's marrow pea is entitled to stand highly prized, from its great delicacy and flavour, and from the difficulty of saving its seed; and Bishop's pea has the same claim, as one of the most productive and early varieties; but I must observe that Bishop's pea, of all others, is most benefited by a liberal manuring of old hot-bed dung. But though Bishop's pea is so well deserving of praise as an early pea, it has little merit as a late pea, except as to producing plenty of seed. Knight's marrow deserves a high price, for flavour, produce, and difficulty of saving the seed.

I am, Sir, yours, &c.

Mill Grove, near Whitehaven,
October 3. 1831.

ANTHONY ADAMSON.

ART. XXVIII. *An Account of the Otaheitean Method of preparing the Arrow-root.* By ANDREW MATHEWS, Esq., of Lima.

Sir,

By this I trust you have received my letter of August last, which will inform you of my having crossed the Cordillera of the Andes. Since then, I have learned from Dr. Hooker, that he has published a description of the route by Mr. Cruikshanks; I shall therefore reserve what I intended to send you on that subject, till I receive Dr. Hooker's publication. In the mean time, I send you an account of the Otaheitean method of preparing the arrow-root of commerce, as I witnessed it performed in that island; hoping that it may be the means of attracting the attention of some persons in Great Britain connected with those islands, and be a means of establishing a more direct intercourse with the inhabitants.

The root (*Tacca pinnatifida* Lin., *Ency. of Plants*, p. 256. fig. 4321., the *Pea* of the natives) grows in the greatest abundance in all the islands which we visited; viz., in Otaheite, Eimeo, Huahine, Raiatea, and Otaha. Its favourite situation is on the sides and ridges of the hills which rise directly from the sea, and which are generally covered with a coarse grass, on a red sandy loam. The root is round, white, smooth,

full of eyes like a potato, and from 2 to 3 in. in diameter. The flower-stem rises directly from the root, simple; from 2 to 4 ft. in height, as thick as a man's finger, bearing its flowers in a loose simple umbel on the summit; and, when large and full blown, it presents a beautiful and delicate appearance. The leaf is large, tri-pinnatifid, segments acute, of a rich shining green: it is subject to great variation in the size of the segments, some leaves being much more cut, and having the segments narrower, than others. When a sufficient quantity of the roots is collected, they are taken to a running stream, or to the sea-beach, and washed; the outer skin is carefully scraped off at the same time with a shell; and those who are particular in the preparation scrape out even the eyes. The root is then reduced to a pulp, by rubbing it up and down a kind of rasp, made as follows:—A piece of board, about 3 in. wide, and 12 ft. long, is procured, upon which some coarse twine, made of the fibres of the cocoa nut husk, is tightly and regularly wound, and which affords an admirable substitute for a coarse rasp. The pulp, when prepared, is washed first with salt or sea water, through a sieve made of the fibrous web which protects the young frond of the cocoa-nut palm; and the starch, or arrow-root, being carried through with the water, is received in a wooden trough made like the small canoes used by the natives. The starch is allowed to settle for a few days; the water is then strained, or, more properly, poured off, and the sediment rewashed with fresh (or river) water. This washing is repeated three times with spring water; after which the deposit is made into balls of about 7 or 8 in. in diameter, and in this state dried in the sun for twelve or twenty-four hours. The balls are then broken, and the powder spread for some days in the sun to dry; after which it is carefully wrapped in *tapa* (the native cloth), and put into baskets, and hung up in the houses. The natural indolence of the people is so great, and their avarice such, that but few of them will give the arrow-root sufficient time to dry, if they have an opportunity of parting with it, which I suspect was the case with that sent to England some few years back by the missionaries. So abundant is the root, that several tons might be prepared annually by proper management: as it is, there is a considerable quantity prepared; it being not only eaten by the natives and strangers on the island, but also by the crews of the vessels that touch there.

At present, when the roots are taken up, the only precaution used to secure a crop the following year is to throw the smaller roots back into the holes from which they were taken, and to leave them to chance. I have no doubt that, with proper

care and cultivation, any quantity might be produced. When we visited the island, we purchased the prepared arrow-root at 2*d.* per lb., and a missionary there informed us, that he would engage to procure any given quantity at 1½*d.* per lb., which is, I believe, much less than it can be purchased at either in the East or the West Indies. Its quality is excellent; I should say equal to that of the East Indies, and far superior to that of Chile, with which I have, since my return, had an opportunity of comparing it. Though there are, at present, many English and North Americans upon the island, I am sorry to say that but few of them have set the natives the example of industry that might have been expected; even the missionaries themselves are still backward in that respect.

As I am likely to remain some years longer in Peru, I have deferred sending you any remarks on the state of agriculture and horticulture in that country, till I become better acquainted with the manners and customs of the inhabitants; but as I am now in possession of a property of about fifty acres, which I am working, and in which I have all the fruits common to the country, I hope to be able shortly to furnish you with something novel and interesting respecting it.

I remain, Sir, yours, &c.

Lima, Dec. 23. 1832.

ANDREW MATHEWS.

ART. XXIX. *Description of the Petre Pear, a fine Seedling Butter Pear, cultivated in the Bartram Botanic Garden, near Philadelphia.* By Colonel ROBERT CARR, Proprietor of that Garden.

PETRE Pear (*fig.* 120., full size). — A middle-sized tree; branches smooth and brown; leaves on long slender petioles. Narrow leaves, oblong lanceolate, base acute, end acuminate, hardly crenate, entire at the base, about 2 in. long, very smooth, midrib yellow. Fruit clustered two or three; peduncle curved, brown, half an inch. Pear oboval, truncate at both ends, 3 or 4 in. long, swelled at top. Skin thin, greenish yellow, with small pale spots. Inside white, soft, juicy, melting, like a butter pear; delicious flavour, peculiar, very slightly musky, and vinous.

The tree which produces the above exquisite fruit was raised from a seed, received in a letter from Lord Petre of England, about the year 1735, and planted by Mr. Bartram near one end of the dwelling-house, at the edge of a gravel walk, where it has never received any manure or rich earth. The roots extend to the walls of the house. The tree has

120

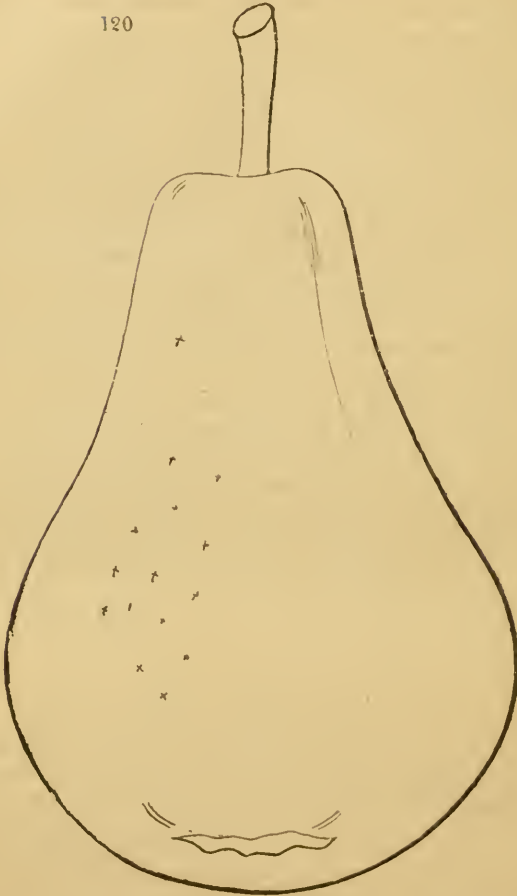

never been subject to blight, and has not once failed to bear in the last thirty years; some seasons producing 10 or 12 bushels of fine handsome fruit, which is in good eating from the middle of September to Christmas. The fruit is always worth from three dollars to five dollars a bushel. The stem of the tree is about 14 in. in diameter, and 25 ft. high. It is in the most perfect health, although near a century old, and has probably borne near 500 bushels of pears. Mr. Bartram informed me that the tree was about twenty years old before it produced fruit, and narrowly escaped being cut down as barren.

I am, Sir, yours, &c.

Bartram's Botanic Garden, Nov. 1831.

ROBERT CARR.

ART. XXX. *Minor Communications.*

SUTTON WASH Embankment.—Sir, I saw in your Magazine for December last (Vol. VII. p. 674.) a notice respecting Sutton Wash embankment, &c., wherein you wish for additional information to the marvellous accounts found in the newspapers respecting it. I waited the publication of two succeeding Numbers, in the hope of seeing some response to your wishes; and, as that hope has been in vain, I beg leave to offer this general outline of the matter.

Sutton Wash forms one of the outlets of the basin of the Wash, as Dupin terms it, through which near 7000 square miles are drained to the sea, and it may also be said to be the identical Red Sea of the ill-fated King John. From the time of the Romans to the present, various works have been attempted to rid this basin of the tidal and land floods. The success attending these works was according to the ingenuity of the artist employed, and the coincident energy of the proprietors; and the benefits obtained from them were generally partial, the projectors profiting at the expense of their more negligent neighbours. These works, depending chiefly upon individuals, were often neglected, and the benefits they produced were often lost for want of timely precaution and attention; so that I think I am warranted in stating, that it was not until the commencement of the present century that the subject was taken up as a whole; and it was reserved for the capacious mind of the late Mr. Rennie, to give the outline of this magnificent undertaking. It has been partly carried into execution by improving the outfalls of the three rivers whose embouchures united form the Wash, locally so called; viz., the Welland at Fosdyke Wash, the Nene at Sutton Wash, and the Ouse at Lynn. The system pursued was, to confine the channel by excavation and embanking, so that sufficient power might be gained to wear down the soil, and prevent the accumulation of shoals, which, in their original state, were continually shifting and reforming, as the irrun of the North Sea or power of the land floods predominated, and destroyed that continuous inclined plane which is so necessary for a perfect drainage. Fosdyke was the first acted upon; but, from some cause that I am unable to explain, the outfall was not carried far enough to seaward to reach deep water, or a drifting set of the tide. The consequence is, that the channel shifts considerably, and the benefit is only partial; but in the course of a few years it may be easily remedied. The next in the order of time was Lynn Wash, locally known as the Eau Brink Cut, completed in 1821; and this extensive and

well conducted public work has produced very beneficial effects in point of drainage. The bed of the river for 9 miles upwards is lowered 5 ft., which has caused many other internal improvements, particularly the lowering of the great sluice at Denver, now in hand. It is worthy of remark, that, as soon as the freshes were diverted from the old channel, the warping action of the tides commenced; and in six years' time the mail coach passed over without a bridge, where any frigate in His Majesty's service might once have floated. We now come to the Sutton Wash; being the last, and most difficult to execute, on account of its great width: but the experience gained in the two former cases has brought it to a perfect completion. In this case, likewise, the plan embraced every thing possible; and, whether considered as a drainage, embankment, navigable outfall, system of warping, or means of communication by its road and bridge, I venture to say that there are few cases where they are all combined, with so little injury to local interests. The line of communication is continued over Fosdyke, and over the Eau Brink Cut, and Old Channel, near Lynn; instead of the old mode of crossing by fording and ferries. By these means, the distance by road has been shortened near thirty miles between Lynn and Boston, and thereby a new direction has been given to the traffic between the north of England and the county of Norfolk. I may here remark, there are yet a few additions wanted to make this line perfect; for instance, between Fosdyke and Boston four miles of the road are at this moment ungravelled; after leaving Boston, between three and four miles are lost in crossing the south 40 ft. drain twice, though, by passing through Swineshead, a road might be easily formed on the north bank of the south 40 ft. A tremendous hill occurs near Leadenham, about ten miles from Newark, which might be easily avoided, at a reasonable expense; I do not know whether it is a turnpike: if not, I should conceive it would answer to be made one. Although I have introduced several subjects, I trust you consider them as bearing upon, and elucidating, the Sutton Wash. I am, Sir, yours, &c. — *W. Thorold. Norwich, April 19. 1832.*

Our correspondent has obligingly sent us a map, showing the situation of the banks, roads, and waters, described or referred to in his paper, but we regret that, from the space they would require to render them at all intelligible, we cannot find room for them. — *Cond.*

An Apparatus for enabling Well-Sinkers to explode their Blasts, when sinking Wells in Rocks. — Sir, I send you an idea of mine for enabling well-sinkers to explode their blasts (in

121

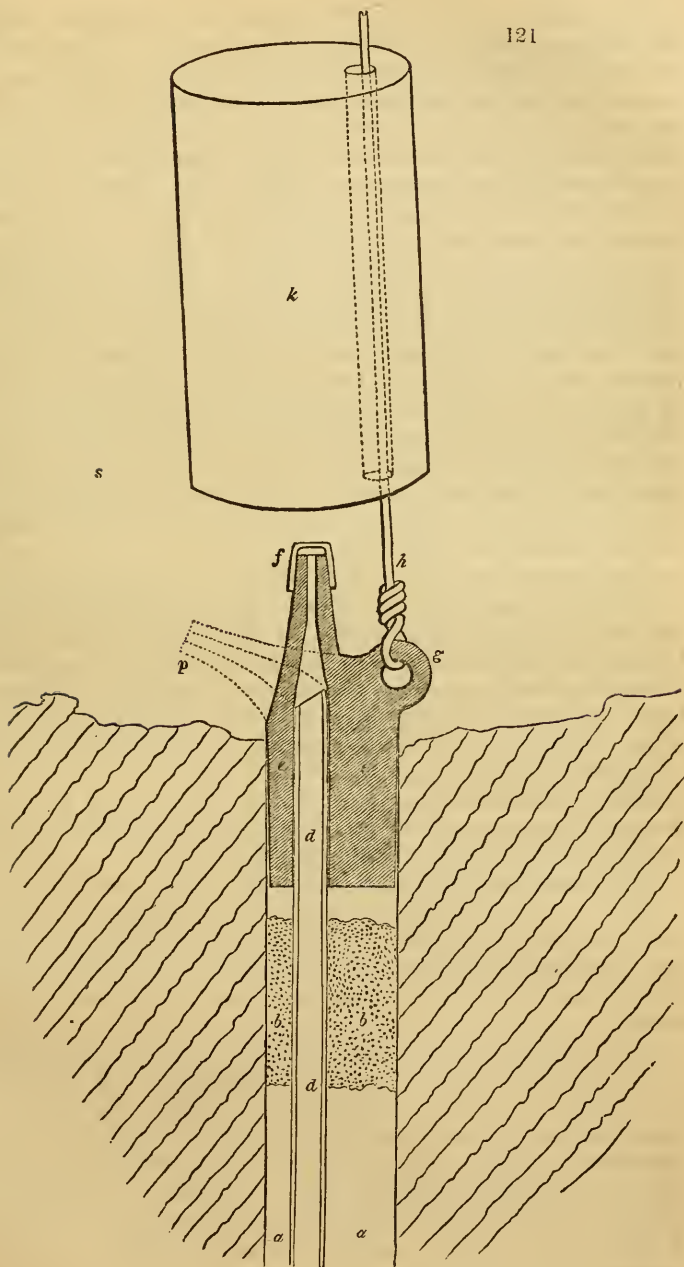

sinking wells in rocks) from the top of the well; thus avoiding the great danger to which they are exposed if they set fire to a train at the bottom, and are then drawn up in the bucket, as usual at present, by which many lives are lost. *Fig. 121.* represents a section of a jumper hole in the rock, at the bottom of a well: *a* is part of the charge of gunpowder; *b* is the sand usually placed above the charge; *d* is a tube, generally a straw (filled in this case with common dry powder), which is inserted into the hollow of the steel plug (*e*), which is turned, and just fits the jumper hole, in which it is steadied by a single blow of a hammer. The upper part of this plug is formed to receive a common detonating cap (*f*), such as is used for firing fowling-pieces. There is an eye at *g*, to which an iron wire (*h*) is fastened, and on which a cylindrical weight of cast iron (of from one to five pounds' weight, according to the depth or shallowness of the well) slides. The hole for the wire is bored in this, at such a distance from the centre of the cylinder end, as to allow it, when the wire is stretched from the top of the well, to fall fairly over the cap, a little inclining to the side marked *s*.

The mode of using this is pretty obvious: all being prepared below, the well-sinker goes to the top of the shaft, slips the weight on the wire, fastens the wire to some appropriate part of the windlass, and then lets go the weight, and retires. If fixed properly, it falls with its centre of gravity directly over the caps; and, exploding, it fires the blast. The steel plug, weight, &c., will not be injured by the explosion, and, of course, may be used many times.

The dotted lines at *p* show that the situation of the cap, &c., may be changed, so as to suit either a horizontal or a vertical blast, or any thing between the two.

The whole apparatus costs but a few shillings, and, I think, would be far more certain, safe, and expeditious than the mode at present adopted. If objections be made to the danger of the plug being of steel, it may be all of copper, except the part on which the cap fits, and which never touches the stone.

It is obvious that this mode of firing blasts is not confined to well-sinking only, but that a little tripod stand of 4 or 5 ft. in height, will form a support, from which any common quarry blast may be fired from a distance with greater safety and certainty, and less loss of time, than by any mode now in use, so far as my knowledge goes. Horizontal or inclined blasts, in a quarry, may be fired the same way as in a well. — Yours, &c. — *Robert Mallet.* 94. *Capel-Street, Dublin,* August 6. 1832.

MISCELLANEOUS INTELLIGENCE.

ART. I. *Domestic Notices.*

ENGLAND.

THE *Botanical Collection of the late Comtesse de Vandes, at Bayswater*, was sold by auction, August 13. The plants, as might be expected, brought very little, though many of them were large and beautifully grown, and others rare. A fine specimen of *Acacia armata*, for which a nurseryman a few years ago offered 15 guineas, was now bought by the same nurseryman for 13 shillings! Some of the finest hot-house plants averaged less per pot than is obtained for pots of mignonette in Covent Garden Market; but two magnificent specimens of rare and beautiful epiphytes, *Stanhopea insignis* and *Cattleya labiata*, brought six pounds, about a third of their worth. A grotesque specimen of *Aloe plicatilis* was bought by an amateur for two guineas. On the whole, the collection being more centrally situated, both for the trade and amateurs, than that at Bury Hill (sold about this time last year), brought rather better prices.

We know of no private collection of hot-house plants that could compete with either of these, now no longer in existence; nor do we expect soon, if ever, to see their like again. The times are changed, and changing, in all that relates to private wealth and monopoly; and we must now look to associations for those displays of riches, and even of taste and connoisseurship, which have heretofore been confined to individuals. This change will, no doubt, be lamented by some, as indicating a state of degeneracy and decay; but we look upon it in a very different point of view. The greatest happiness of the greatest number is our standard for testing all changes; and, consequently, while we regret the dispersion of this private and secluded collection (so completely secluded, that strangers were seldom permitted to see it) chiefly because it was in our own neighbourhood, we rejoice at the prospect of another botanic garden being formed (that on Primrose Hill), to which all the world may have access. We hope, also, that the unequalled collection of Messrs. Loddiges will be long easily accessible to amateurs. We trust something good is awaiting Mr. Campbell, the skilful and successful curator of the late Comtesse's establishment, than whom there is not a more amiable and worthy man, or a better gardener. — *Cond.*

Cereus speciosissimus has lately bloomed magnificently at Dropmore. It has frequently had from forty to fifty flowers expanded at one time, and altogether the number of flowers which it has produced in the course of the season exceeded 200. The whole of the grounds at Dropmore have been greatly improved since you and I last saw them together, and the pines and firs are some of them twice the height that they were in 1826. — *J. The Inn at Maidenhead, July 16. 1832.*

A new *Strawberry*, which attains a large size, has been raised from seed by Mr. Darke, at Bordesley, near Birmingham. The seed was produced by a flower of Wilmot's Superb, which had been impregnated by the pollen of the Downton. It sends up its scapes very high, and seems very prolific. Some of the fruit was sent us by Mr. Darke, but it did not arrive in such a state as to enable us to judge of its flavour.

Mr. Hogg's Show of Carnations, at Paddington, has been this year more than usually splendid. Nothing could exceed the beauty of his yellow

picotees. Various new seedlings have bloomed for the first time. Mr. Hogg has got an ingenious instrument for stamping out the cards for dressing his flowers, which we shall figure and describe in an early Number.

The Conservatories at the Colosseum may be said to be now completed, by the addition of the marine grotto, so admirably got up under the direction of Mr. Gray, whose merits, we are happy to find, are beginning to be appreciated by those who have grounds to lay out, and rustic buildings to execute, in the country. The marine grotto is certainly one of the most extraordinary imitations of nature which we have ever seen, and we could wish that it might lead to a new taste in laying out the gardens of suburban coffee-houses. We expect a great deal, at no distant period, from the gardens of all public establishments, from the common public-house upwards; and we expect, also, that in time most villages and country towns will have their public parks, their conservatories as magnificent as that of the Duke of Northumberland or of the Earl of Shrewsbury, their museums, colleges, libraries, &c. In short, whatever is now enjoyed, or rather possessed, by a few, will soon be enjoyed by the many; but this is not the place to enlarge on coming changes, though, as society is always progressing, if we did not occasionally look forward, we should very soon find ourselves left behind.

The Gardens of the Zoological Society, Regent's Park, are every season improving. We only wish we could persuade the liberal and enlightened secretary to have the more conspicuous plants handsomely named, as well as the animals. What might not have been done for public taste, and the ornament and intellectual improvement of the metropolis, if the whole of the Regent's Park had been one Arboretum and Botanic Garden! We do not mean a dug garden; but merely that all sorts of hardy trees, shrubs, and plants should have been introduced, and named, instead of the common sorts that are now planted, or have sprung up naturally. Why not have broad irregular patches of all the different sorts of grasses in the open park, all the herbaceous plants which will grow under the partial shade of trees, and all the other herbaceous plants among low shrubs, artificial rocks, or in the waters? Why not, indeed?

The Surrey Zoological Gardens are in a prosperous state, and reflect the highest credit upon all concerned. Many of the botanical articles are there named, as well as the zoological ones; and a very elegant publication, entitled *Illustrations of the Surrey Zoological Gardens*, with beautiful drawings of their finest animals, is now publishing in monthly parts.

Mr. Groom's Garden, in the neighbourhood of the Surrey Zoological Gardens, will be visited by every florist of taste; and they will there see, at this time, a new pea, which is expected to turn out a valuable addition to our culinary legumes.

The Gardens of the Beulah Spa have been kept up with great care and taste, during the summer, under the direction of our intelligent and industrious correspondent, Mr. Pringle, who has just left the situation, and who merits something a great deal better. We shall never consider Mr. Pringle in a place suited to his abilities, till he is at the head of some public botanic establishment, or a general manager of a gentleman's estate.

The Primrose Hill Botanic Garden, mentioned in our last, p. 470., is meeting with numerous supporters, and, we trust, will eventually be carried into execution. A correspondent suggests that the circle in the centre of the Regent's Park would be a much better situation. This was proposed by us in the *Mag. Nat. Hist.* in 1828; and subsequently, by our ingenious correspondent, C. M. Willich, Esq., in his plan for a metropolitan garden.—*Cont.*

A new Apparatus for heating by hot Water.—Sir, In the *Gardener's Magazine* you have given descriptions of various methods of heating horti-

cultural houses by hot water, and, amongst the number, a plan (Vol. VI. p. 374.) of which I had formerly a good opinion. Since that plan was executed I have been tempted to adopt others in my establishment, with every one of which, in its turn, I have felt satisfied; but such is the march of intellect, that we are now daily surprised by new inventions, and with none of these, as far as respects heating with hot water, have I been more pleased than with a very simple, cheap, and powerful apparatus, just invented by Mr. Weeks, of the King's Road, Chelsea. I was induced to make trial of this, by having one put up in my office, and its erection and completion did not occupy quite four days; in fact, I had a fire in it on the third day, to prove its power, &c., and, in twenty minutes (including the time of lighting), every part of the apparatus was heated to excess, and the water was boiling with great violence, the office in a very short time becoming excessively hot. It is right to say that the fuel consisted of shavings and wood. I consider this apparatus well adapted, not only to horticultural houses, but also to all kinds of buildings requiring either quick and powerful or moderate heat; the water appears to descend and ascend as occasion may require. The consumption of fuel, I have good reason to think, will be much less than in any other apparatus with which I am acquainted. I hope you will soon be furnished with the means of making this very important invention known to all your friends. I am, Sir, yours, &c. — *Joseph Knight. Exotic Nursery, King's Road, Chelsea, Sept. 15. 1832.*

We have seen this apparatus, and it may be shortly characterised as a mode of heating and circulating water in small tubes in Mr. Perkins's manner, without a boiler; but differing from it, in not having the tubes hermetically sealed. The chief advantage which we can see in this new apparatus, over those in common use, is, that it has the power, to a certain extent, of circulating the water below the level of the fire. This is unquestionably a most valuable improvement, and though it has been before obtained through mechanical means by Mr. Busby (see *Repertory of Arts*, vol. xiv. p. 137.), and by Mr. Perkins with his hermetically sealed tubes, it has never, till now, been effected by an open apparatus alone; we shall give detailed accounts of both Mr. Busby's method and that of Mr. Weeks in an early Number. — *Cond.*

SCOTLAND.

Glasgow, August 18. — Since I last wrote to you, I have been at Ayr, and visited that delightful place, Auchincruive. I could not help being much struck with the open-hearted and kind manner of Mr. Skinner, the gardener there, and I could almost have fancied him an Englishman, if I had not found that he was rather more particular in his religious opinions than my countrymen generally are. What numbers of people pass their lives, in England, travelling from one watering-place to another, without having the least idea that there is such magnificent scenery in Great Britain as that seen from the lawn at Auchincruive! I looked down on the roaring waters, and followed them with my eye, till they were lost in a chasm clothed with wood on one side, and displaying nothing but naked rock on the other. I then raised my eyes to the hill which is on the other side of the river, and, after admiring its varied woods and lawns, I turned to the left, and looked down on terraced garden scenery which might vie with that of Italy. What a place to retire to from the bustle of a great city! I think I still hear the sound of the waters, and see Skinner so anxious to show every thing off to the best advantage, and talking of his master with such veneration and respect. Mr. Oswald must be a good man, to inspire such ardent feelings in his dependants. I went to see Colesfield,

and was charmed with the situation of the Grecian villa on the romantic bank of the same river. I could not, however, forget Auchincruive; and am afraid the beauties of Colesfield were in a great measure lost upon me. I was obliged to return rapidly to Paisley, and had not time to visit the many other beautiful seats with which I was told this neighbourhood abounds; but, as Glasgow will be my head-quarters for some time, I hope to make another excursion to Ayrshire.

From Paisley I went with Mr. B. and another gentleman to Castle Semple; "a pretty melancholy place," as Evelyn would have called it. Whether I am right or wrong I cannot say; but the impression produced on me by this place was that of profound melancholy. The whole park, which is extensive, and the farm, gardens, and pleasure-grounds, occupy the face of a bank of 300 or 400 acres, at the south base of which is a natural lake, upwards of a mile in length. The park abounds in fine trees, and both it and the pleasure-grounds are kept in excellent order. What I disliked most about this place was the kitchen-garden, which seems to me to have been completely overdone. The walls are much too high, and are ponderously constructed; and the carpentry of the hot-houses is of the last age. I was surprised to find rather poor crops in the vineries, which I was told was owing to the defective manner in which the borders are constructed; I was told in what the error consisted, but have forgotten. I would recommend you to ascertain it from the gardener, Mr. Lauder, a very intelligent young man, who, I believe, reads your Magazine, through the favour of his very excellent master and mistress. As every thing in the building way appears to have been conducted here on a most magnificent scale, and as you know I take a great interest in the homes of the working classes all over the world, I was curious to know what sort of a house Lauder had got. Judge of my surprise, when he took me to a low-ceilinged damp cell, as I may call it, in which one room serves both as bedroom and parlour. He endeavoured to apologise for the dampness, by showing me that on one side of the house the earth was as high as the windows. I must do him the justice to say that he made no complaints, though I do not believe that there is a gardener's house in all England so unfit for a human dwelling. I asked to see the lodging-rooms of the journeymen, but, bad as Lauder's house was, it was a palace compared with theirs. There were only two rooms, each about 12 ft. by 9 ft., for the eating and sleeping of six men; and the sleeping-room was filled up so entirely with the beds, that it was difficult to get into it. I am afraid your *Cottage Architecture* will not meet cases of this kind. The lodge of these men, as well as Lauder's house, forms a lean-to to the garden wall; and it would never occur to a country gentleman that plans for detached dwellings surrounded by terraces or platforms, such as your designs, would suit such situations. You should give plans for gardener's houses, connected with the kitchen-garden walls, and I think you would do most good by giving them in your Magazine, which is read by many who will never see what is to me by far the more interesting work. You shall hear again soon from yours, &c. — *An Englishman.*

ART. II. *Floricultural and Botanical Notices of new Plants, and of old Plants of Interest, supplementary to the latest Editions of the "Encyclopædia of Plants," and of the "Hortus Britannicus."*

Curtis's Botanical Magazine; each monthly Number containing eight plates, 3s. 6d. coloured, 3s. plain. Edited by Dr. Hooker, King's Professor of Botany in the University of Glasgow.

Edwards's Botanical Register; each monthly Number containing eight plates; 4s. coloured, 3s. plain. Edited by John Lindley, F.R.S., Professor of Botany in the London University.

Sweet's British Flower-Garden; each monthly Number containing four plates; 3s. coloured, 2s. 3d. plain. Edited by Robert Sweet, F.L.S., author of several botanical works.

Loddiges's Botanical Cabinet; each monthly Number containing ten plates; 5s. coloured, 2s. 6d. partly coloured. Edited by Messrs. Loddiges.

Maund's Botanic Garden; each monthly Number containing one plate, bearing pictures of four plants; 1s. 6d. coloured and large paper, 1s. small paper. Edited by Benjamin Maund.

The reader will find the few abbreviations used in the following extracts explained in p. 12.

DICOTYLEDONOUS POLYPETALOUS PLANTS.

III. *Ranunculaceæ* § *spuriæ*.

1596. *PÆONIA* 14098 officinalis

7 *anemoniflora* Hook. *Anemone-flwd.* ✱ 2 or 3 my.jn R ... 1830? D s.l Bot. mag. 3175

"This richly and very deeply coloured pæony is figured from the garden of the Rev. J. T. Huntley, of Kimbolton, Huntingdonshire, who received it from the Prince de Salm-Dyck. Its stamens are converted into narrow, acuminate, and spirally-twisted petals, bearing the same relation to *P. officinalis* as the anemone-flowered or Waratah camellia does to the true *Camellia japonica*, and it is scarcely less beautiful in its appearance." (*Bot. Mag.*, Aug.)

XVI. *Dilleniacæ*.

1597. *HIBBERTIA*.

14115a *Cunninghamii* Ait. Cunningham's 2 or 2 jn Y Kg.G.'s Sd. 1823? C s.p Bot. mag. 3183

A somewhat twining shrub, with slender branching stems, and glabrous linear entire leaves two or three inches long: on a warm sunny day it is almost covered with its bright yellow, but fugacious, blossoms, and is, consequently, a very pretty plant. The specific name is in compliment to its introducer, Mr. Allan Cunningham: "a name," Dr. Hooker observes, "likely to be still more intimately connected with the botany of New Holland, than it has even yet been, now that Mr. Richard Cunningham is appointed to be the successor of Mr. Fraser, the late colonial botanist at Sydney, for which country he is very shortly to embark." (*Bot. Mag.*, Sept. 1832.) [Mr. Richard Cunningham sailed on the 18th of August.]

XXIV. *Malvaceæ*.

2023. *SIDA* § iii. Heart-leaved.

14115a *aurea* B.C. golden-flwd. ✱ □ or ... my.jl O.R India 1830? C l.p Bot. cab. 1842

Messrs. Loddiges received this from their valued friend, Mr. Charles Stokes. It was raised from Indian seeds, and requires the stove, where its flowers continue long in succession. (*Bot. Cab.*, Sept.)

XXXII. *Ternstroemiaceæ*.

2038. *CAMELLIA* 18166 japonica

var. *compacta* B.C. compact-flwd. ✱ □ or 4 n.f W England seedling I l.p Bot. cab. 1836

"This," say Messrs. Loddiges, "is a neat small-flowering variety, distinct from every other white, having a good deal of the character of the *C. Sasangua* in the flower, but the leaves of *C. japonica*." Each flower seems to consist of many petals, but still shows several stamens. (*Bot. Cab.*, Aug.)

XLVI. *Cactæ* § *Opuntiacæ*.

1471. *MAMMILLA*'RIA.

tenuis Dec. slender ✱ ⊞ gr ½ my Pa.Y ... 1830. O ru Bot. reg. 1523

A very interesting species, exhibiting a "curious intricacy of structure." It propagates readily by means of the little round hedgehog-like bulbs

which it produces in abundance. These planted in a compost of lime rubbish and a little vegetable soil, kept just damp, will speedily emit roots, and establish themselves, and then nothing but frost or overwatering will destroy them." (*Bot. Reg.*, Sept.)

XLVII. *Onagrariæ* § *Fuchsiae*. *Fuchsia globosa Hort.*, and *Fuchsia bacillaris Lindley*. In p. 505. we have attempted to describe the admirableness of a plant of *Fuchsia globosa Hort.*, as grown by Mr. Dennis, nurseryman, Chelsea, but have grossly erred in stating it to be identical with *Fuchsia bacillaris* of *Lindley* in the *Botanical Register*, t. 1480. The two kinds are as distinct as any two kinds of one genus need to be. On comparing the two, although the specimens we inspected were unequal in size and age, the following differences were perceptible:—*F. bacillaris* has ascending branches; elliptical leaves, which are acuminate tapered to both ends, and perfectly smooth in every part; its flowers resemble those of *F. thymifolia*, and somewhat those of *F. microphylla*; and they have not their stamens projected beyond the free tubular part of the calyx. The branches of *F. globosa* are decurved, from which depend, on slender pedicels 1 in. in length, very numerous flowers; thus forming pleasing crimson wreaths. The leaves are somewhat heart-shaped at the base, acuminate, serrate, and fringed with short, and probably deciduous, pubescence. The flower, before expansion (see p. 505.), is globose; but, when expanded, much resembles that of *F. conica*, and has its stamens projected beyond the extent of both the crimson sepals and purple petals. Until some botanist publishes a more perfect history of it, we shall here provisionally register it. *F. bacillaris* is noticed in p. 225., and registered in the *Additional Supplement*, p. 589.

1188. FUCHSIA. § 2. (Macrostemææ) Stamens projecting beyond the sepals and petals. 1
10075a *globosa Hort.* globose-flwd.  or 5 jns. C.P. Eng. hybrid? 1830. C p.1

F. globosa is said to have been originated by some gentleman's gardener, from seeds cross-impregnated between *F. conica* and *F. microphylla*.

1185 CLARKIA 10047 pulchella

2 flore albo Swt. white-flowered O or 1½ ju W N.Amer. 1826. S co Sw.fl.gar.2.s.157.

"The flowers of *Clarkia pulchella* are found of various shades of purple in the cultivated plant; but the white variety represented in our plate is more particularly deserving of notice." (*British Flower-Garden*, Sept.)



LX. *Proteaceæ*.

316. GREVILLEA.

†28900a *robusta Cun.* robust or silk oak  or 80 ... O Moreton B. 1830. C 1 p Bot.mag.3184

This species is figured from native specimens; the only plant in Britain, in the Kew Gardens, not having yet flowered in this country. "This noble species of *Grevillea*," Mr. Cunningham, its introducer, remarks, "in the thick moist woods on the banks of the Brisbane River, vies in size and stature with the *Flindersia*, *Oxleya*, and other large forest trees; but by none is it surpassed in height in its native woods, except by the *Aracaria* of those regions, whose level-topped branching head is seen rising far above all the rest. Some aged trunks of *Grevillea robusta* I have found to measure nine feet in circumference; so that it is probably the largest tree of the order [*Proteaceæ*] that has yet been discovered, surpassing both the *Knightia* of New Zealand, and the *Orites* [*oreitēs*, an inhabitant of mountains] *excelsa Br.* of Port Macquarie. From its deeply dissected foliage, and the silkiness of the under side, it has obtained the name of "Silk oak" among the pine-cutters of Moreton Bay: but its timber, which is of a toughish fibre, has not been appropriated to any use." (*Bot. Mag.*, September.)

We have presented the tabular details of this species above, because in our published *Additional Supplement*, p. 590., by a shifting of the type, the details of this species, and of *Calèyi*, have been mutually transposed; the tabular description of *Grevillea Calèyi* is therefore this:—

- †28899 Calèyi R.Br. Caley's  or 5 jn.s R PortJack. 1829. C p.l Bot.mag.3133
Blechnifolia Cun. MSS. Blechnum-leaved.
 2626a canèscens R.Br. hoary-ld.  cu 5 ... G.Taw. PortJack. 1824. C s.p Bot.mag.3185

Closely related to *G. cinèrea*, but *G. canèscens* has the segment of its perianth much more acuminate than has *G. arenària*, whose flowers, too, are of a dingy purple colour. *G. canèscens* has this interesting feature, its perianth is curved like a horseshoe, swollen towards the apex, and then suddenly much acuminate, so as to resemble the head and beak of a bird. (*Bot. Mag.*, September.)

LXXIII. *Rosàcèæ*.

1522. RO'SA 13470 *indica*
 var. *Smithii* Swt. Sm.'s *yel. Noisette*  or 5 sp.su Y Eng. hybrid 1829 C r.l Sw.fl.gar.2.s.158

"A hybrid production from the Noisette rose, fertilised by the pollen of the yellow China rose, raised by Mr. W. Smith of Coombe Wood. It resembles the double yellow China rose in many respects, but is of much more vigorous growth. Its flowers are about the size of those of the double yellow China rose, but of a deeper yellow, and, like those of the Noisette rose, are disposed in clustered corymbs of from ten to twenty-two; they are highly fragrant. This new kind of rose is perfectly hardy, is readily increased by cuttings, and may be regarded as a most valuable addition to our already numerous list of China roses. (*British Flower-Garden*, Sept.)

LXXVII. *Leguminòsæ* § *Sophòrèæ*.

1246. CHORO'ZEMA.
 10500a ovàtum Lindl. ovate-leaved  el 1 my S N.Holl. 1830 C s.p Bot. reg. 1528

An elegant plant, and highly decorative in its largish blossoms, whose vexillum is scarlet with a yellow spot at its base: the wings are purplish. "Its characters are more those of *C. rhómbeum* than of any other species; but it is decidedly distinct." Raised in the nursery of Mr. Knight, from seeds gathered in the south-west of New Holland, by Mr. William Baxter. (*Bot. Reg.*, Sept.)

1257. DILLWY'NIA?
glycinifolia Sm. Glycine-ld.  el 1½ ap O.Ro S.W.N.Holl. 1830 S s.p Bot. reg. 1514

An exquisitely beautiful green-house plant, raised by Mr. Knight of the Exotic Nursery, Chelsea, out of the collection of seeds purchased by him of Mr. Baxter, who collected them in New Holland. Botanists doubt if this plant be a species of *Dillwýnia*; and Professor Lindley regrets that the doubt "seems little likely to be cleared up; although," he remarks, "it is now nearly thirty years since materials for the completion of the Flora of New Holland were furnished by the liberality of the British Government. It is time that this were looked to; and much to be wished that some enterprising naturalist would convert to a useful purpose the rich stores of information regarding Australian vegetation procured at the national expense, and now open to all enquirers, which are lying unemployed at the British Museum. When we see the fate of the plants collected in Flinders's expedition, and in the fatal journey up the Congo, by the lamented Christian Smith, we can scarcely wonder that a wise and careful government should object to pay the expenses of scientific expeditions."

Leguminòsæ § *Phaseòlæ*. *Kennèdya dilatàta* Cun. is figured in the *Botanical Register* for September, t. 1526., from Mr. Knight's nursery, where it flowered in April last. It is a prostrate or climbing plant, beautiful in its headlike racemes of blossoms, which are scarlet in their standard, yellow in their centre, and purplish in their wings. In its affinity it is stated to be intermediate between *K. prostràta* and *K. inophýlla*. Raised from seeds collected by Mr. William Baxter, on the south-west coast of New Holland. (*Bot Reg.*, Sept.)

Lupinus mexicanus is figured in Maund's *Botanic Garden* for August,

t. 366., where this remark is offered:—“Its habit being at first unknown, it was soon lost; but in these days of research in every quarter of the globe, such losses in general meet speedy reparation. To the personal exertions, and also the pecuniary liberality, of men of science and fortune, these advantages are principally owing. Many botanists, however, in foreign countries are now wholly or partly employed by English nurserymen to send new and rare plants to England; therefore every customer of the nurseryman is an individual subscriber to the great object of exploring remote corners of the globe.”

Leguminosæ § *Mimosææ*. *Acacia cinerascens* Sieber, an arborescent species, with glaucous longish leaves, and cylindrical pendent spikes of yellow flowers, is figured in the *Bot. Mag.* for August; where are presented, from the pen of that zealous and intelligent naturalist and traveller, Mr. Allan Cunningham, the following notices on the distribution of the genus *Acacia* over the continent of Australia. The genus *Acacia* “inhabits not only the southern coasts, but all parts of the interior that have hitherto been explored. Wherever I landed, during my four and a half years’ voyage with Captain King, an *Acacia* was sure to welcome me on my landing, and the last plant on which the eye rested, on those inhospitable steppes to which Mr. Oxley traced the Lachlan River, in 1827 (five hundred miles inland from Sydney), was my *Acacia stenophylla*, a curious slender tree, 20 ft. in height, with leaves [phyllocladia] from 12 to 15 in. in length.”

2837 *ACA'CIA* § *Julibrissinæ*.

pentadènia Lindl. 5-glanded-*lvd.* ■ □] or 5 sp Y N.Holl.s.w.c. 1830 C p Bot. reg. 1521

Raised by Mr. Knight. If not equal to such species as *A. pubescens* in the beauty of its blossoms, it is perhaps superior to them in the graceful character of its foliage. Professor Lindley names it, in English, the Fern-leaved *Acacia*. “The little glands that are seated upon the petiole, between each pair of pinnae, are of a highly curious character; they have the form of a minute cup, and seem as if they were destined to expose some portion of the inner substance of the petiole to the action of air or light; but for what purpose we are ignorant. One could almost fancy an analogy between the origin of these and of the shields of lichens.” (*Bot. Reg.*, Aug.)

CXV. *Diosmeæ*.

Eriostemon buxifolius is figured in the *Bot. Cab.* for August, t. 1831., and thus excellently described:—“It is an exceedingly pretty plant, growing upright, with many short rigid branches, and producing its elegant flowers in April and May. It is necessary to keep it constantly in the green-house. It will increase by cuttings slowly, and should be potted in sandy peat earth.” *Eriostemon myoporoides* is figured in the *Botanical Magazine* for September, whence we are able to present corrections to the details in *Hort. Brit.* p. 169.

†10930 *myoporoides* Dec. *Myoporun*-like ■ □] or 3 sp W N.Holl. 1823 C s.p.1 Bot. mag. 3180

CXXXI. *Passiflorææ*.

1925. *TACSONIA*.

†28452 *pinnatistipula* J. pinnate-stip. ♀ □ or 30 sp Pa.Ro Chile 1828 C p.1 Sw.fl.gar.2.s.156

This plant is already in Loudon’s *Hort. Brit.* (p. 485.), but with imperfect details. From *Passiflora*, *Tacsonia* is, according to Mr. Sweet, principally distinguished by the long tube of its perianthium. Mr. Sweet’s figure of this elegant plant is derived from the choice collection of Mrs. Maryat, at Wimbledon, where the plant has blossomed two years successively, and this year has nearly filled the conservatory. “Its showy blossoms, which it produces in abundance, claim for it a place in every collection. It is a native of Talehuano and Valparaiso in Chile; and” Mr. Sweet is “inclined to think, that, in favourable situations, it will prove quite as hardy as the common passion flower, *Passiflora cærulea*.” The plant abounds in downiness. (*Flower-Garden*, August.)

DICOTYLEDONOUS MONOPETALOUS PLANTS.

CLXX. *Ericæ* § *vêræ*.

1173. ERICA. § vi. Ovateffdræ.

9800a? villosúscula B.C. slightly villose $\text{■} \square$ or $1\frac{1}{2}$ my Li C.G.H. 1829? C s.p Bot.cab. 1844

“Lately introduced by Mr. Lee. It is a pretty little plant, growing very bushy, and flowering abundantly in May. The flowers are covered with a kind of silky down.” (*Bot. Cab.*, Sept.)

Menziësia empetrifórmis is figured in the *Botanical Magazine* for Aug., t. 3176., and is an elegant botanica gem. “Its leaves in the recent state are decidedly tumid both above and below, being depressed only along the middle rib on either side.”

1345 ARBUTUS.

11079b pilósa *Grah.* hairy-branched $\text{■} \text{■} \text{■}$ cu $\frac{1}{2}$ my W Mexico 1829? L 1.p Bot. mag. 3177

Stated in the *Bot. Mag.* for August to be perfectly hardy in the Cannon-mills and Edinburgh botanic gardens. Its hairy prostrate branches are furnished with numerous toothed evergreen leaves, nine lines long, and four and a half broad; the flowers are not large. Dr. Graham has not yet seen the fruit, so that the plant, it is just possible, may prove a species of *Gaulthéria*, or of *Arctostáphylus*.

Ericæ § *Rhodoræccæ*.

RHODOÐENDRON indicum *Swt.* (521 Azálea 4341 indica *L.*)

var. *Smithii* *Swt.* Smith's $\text{■} \square$ or 1 inr.my Ro.Sal Eng.hyb. 1828 C p.1 Sw.fl.gar.2.s.154

Flowers of a rosy salmon colour, large, and spreading from $2\frac{1}{2}$ in. to 3 in. in expansion, the upper petals spotted with spots of a darker colour than the petals themselves. “This splendid hybrid production is the offspring of *Rhododéndron phœniceum*, that had been fertilised by *R. indicum*, and was raised by Mr. Smith, at Coombe Wood, in the spring of 1828. It partakes of the characters of both parents, and, like them, is rather tender, but appears to be a more desirable plant than either; is of free growth, and produces its flowers in great abundance. Mr. Smith's success in this department of horticulture is well known, his collection surpassing any thing of the kind we have ever seen.” (*Flower-Garden*, August.)

CLXXI. *Epacrideæ*.

3294 SPHENOTOMA.

capitátum *R.Br.* head-spiked $\text{■} \square$ or 1 ap.my W S.W.N.Holl. 1830. C turf.p Bot. reg. 1515

A green-house shrub, that was very pleasingly blooming at Mr. Knight's nursery in April and May last. It produces ornamental heads of snow-white, semitransparent, salver-shaped flowers; it requires “the same treatment as the epacris, styphelias, and other families in the order *Epacrideæ*.” Professor Lindley supposes *Sphenótoma* to be derived from *sphēn*, a wedge; and *temnō*, to cut; in allusion to the wedge-shaped segments of the corolla. (*Bot. Reg.*, Aug.) This etymon differs from that supplied in the *Hortus Britannicus*. Which is the right one?

CLXXIV. *Campanulæcæ*.

605. ADENOPHORA.

†1925 verticilláta *Fis.* whorled-*Ind.* $\text{■} \Delta$ or $2\frac{3}{4}$ jl L.B Siberia 1783. D s.1 Sw.fl.gar.2.s.160
Campanula verticilláta *W.* C. *tetraphylla* *Thun.*

A singular and rare species; figured from the Chelsea Botanic Garden (*British Flower-Garden*, Sept.)

CCXI. *Scrophularinæ*.

65. CALCEOLARIA.

27995a péndula *Swt.* pendulous-*flwd.* $\text{■} \Delta$ or $1\frac{1}{2}$ su Y.Spot Chiloe 1831. S p.1 Sw.fl.gar.2.s.155

Resembles, but is distinct from, *C. crenatiflora*. It is figured from Mr. Low's Clapton Nursery, where, Mr. Sweet believes, but one plant has been raised, which, it is hoped, will produce seeds. From its blossoms being large, and from their hanging down in a graceful manner, it is one of the most showy species of the genus. Mr. Sweet considers that this and

all other kinds of Calceolària may be grown in the open air the year round, if planted in a warm border, and covered with a flower-pot in severe weather. (*Flower-Garden*, August.)

CCXIII. *Solànea*. *Solanum crispum* R. & P. is figured in the *Botanical Register* for August, t. 1516., where this remark is presented respecting it:—"It appears likely to be a hardy plant, in which case it will be very ornamental. If tied to a stake, and thus forced to grow erect, it will throw out a great number of lateral branchlets, at the end of every one of which is a bunch of flowers. In this state it was exhibited by Mr. Low (of the Clapton Nursery), at a meeting of the London Horticultural Society in April last, and was greatly admired. No doubt it will strike root very freely in the state of cuttings. It will grow readily in any common soil." It is a native of Chiloe, and, if not quite hardy, will, doubtless, prove very eligible for the decoration of the hardy garden in summer. It considerably resembles the English bitter-sweet (*Solanum Dulcamàra* L.), but has larger and paler corollas. The specific term *crispum* "has reference to a very slight degree of undulation at the margin of the leaves."

Salpiglóssis atropurpurea is figured in the *Botanical Register* for August, t. 1518., where this physiological speculation is offered, which merits from our brother gardeners their attention at least. When plants of this species are "grown in the open border, they are very apt to die suddenly, so that only a few will sometimes remain out of a whole bed. This is probably owing to the soil, in such instances, being too light, and therefore subject to sudden dryness; a condition which their tender roots are not formed by nature to endure. In Chiloe, where all the species of *Salpiglóssis* grow, they are found springing from the sides of dry clay banks baked hard by the scorching sun of that climate; a situation in which the moisture that the earth contains is parted with with great difficulty, and very slowly." The *salpiglossises* are not the only plants of free and rapid growth prone to die suddenly off, while to all appearance in the fullness of vigour; and the above theory deserves to be compared with every case which may transpire, until its sufficiency or insufficiency is proved.

CCXXI. *Labiàta* § *Ocymóideæ*.

3383. COLEUS.

aromàticus *Benth.* aromatic n. □ fra 1½ mr. my Pa.V India 1826. C p.l Bot. reg. 1520
Còleus amboinicus *Lou.*

Cultivated generally in Indian gardens, chiefly on account of its great fragrance of herbage. Its leaves are frequently eaten with bread and butter, or bruised, and mixed with various articles of food, drink, or medicine. The plant, though pretty in its spike of whorls of smallish pale violet flowers, is not showy: in British gardens it is often called *Gesnèria odoràta*. It is readily increased by cuttings. (*Bot. Reg.*, Aug.)

MONOCOTYLEDONOUS PLANTS.

CCXXXVIII. *Amaryllidèæ*.

979. ALSTREMERIA.

6014a *hamántha* R. & P. blood-col.-flwd. ✱ □ or 2½ j. 1p. O.R. Chile 1830. O 1s.p Sw.fl.gar 2.s.159

Introduced by seeds by Lady Oakes, in whose interesting collection at Mitcham, the plant flowered for the first time in July last. It is an elegant and hitherto little known plant, which appears to require the same treatment as *Alstræmeria Simsii*, to which it is very nearly related. (*British Flower-Garden*, Sept.)

CCXXXIX. *Iridèæ*.

142 IRIS. § *The spreading segments of the perianth beardless.*

nertchinskia *Fis.* Nertchinsk 3 Δ or 4 my B Siberia 1831. D r Bot. cab. 1843

Messrs. Loddiges received this pretty plant from their kind friend Dr. Fischer. They state that it "grows pretty well in any good soil, and increases without difficulty by division at the root." (*Bot. Cab.*, Sept.)

CCXL. *Orchideæ. Collecting and Importing Orchideous Epiphytes.* — “It is very much to be regretted that some more efficient means are not taken to procure the plants of this description which abound in all the tropical parts of the East. They are very tenacious of life, and require no care in collecting, it being only necessary to strip them off the trees on which they grow, and to suspend them in the cabin, never watering them, but moistening them occasionally with a wet sponge. Captains of ships might succeed in importing them without difficulty. The only caution which requires to be taken is, that they should not be overwatered; if this is done, they are sure to die: it would be much better to give them no water whatever. They should also, if possible, be collected in the dry season, at which period they are naturally in a state of torpor.” Professor Lindley, in the *Botanical Register* for September, t. 1522., under *Angræcum ebúrneum*.

The Woodlouse is exceedingly destructive to all Stove Orchideous Plants. — Messrs. Loddiges state to this effect in their description of *Maxillaria Barringtoniæ*, in their *Bot. Cab.* for July, t. 1824. Modes of destroying this insect are prescribed in our Vol. VII. p. 280. and 486.

Orchideæ § *Arethuseæ.*

2518. PTEROSTYLIS. { *Stems leafy, appendix of labellum pencilled at top.*
Banksii R. Br. Banks's ✨ Δ| cu 1½ d Y.W New Zeal. 1826. D p.1 Bot. mag. 3172

Found on the banks of a stream which is received into the Bay of Islands, in New Zealand, by Mr. Allan Cunningham, in 1826, who soon after sent off plants to Kew. Mr. Bauer has found that its grains of pollen, magnified by Ploessel's grand microscope 570 times lineally, or 324,900 times superficially, exhibit a total deviation from those of all the hundreds of specimens of orchideous plants he had before investigated. The species has large leaves, and Mr. Cunningham had named the species *P. macrophýlla*: but Mr. Brown has identified it with a specimen found by Sir Joseph Banks in New Zealand, when he accompanied Captain Cook round the world, and of which a specimen or drawing still exists in the Banksian museum. (*Bot. Mag.*, Aug.)

Orchideæ § *Ophrydeæ.*

2487. A'CERAS.
22515a secundiflora Lindl. one-sided spiked ✨ Δ| cu ¾ ap D| V S. Europe 1829? D 1p Bot. reg. 1523

“It is a neat little plant, requiring the same kind of treatment as *ixias* and other Cape bulbs: that is to say, to be kept quite dry and quiescent during summer. Under such management, Mr. Henderson, at Lord Milton's, succeeds in making it flower freely every spring.” (*Bot. Reg.*, Sept.)

Orchideæ § *Vándeæ.*

2537 MAXILLA'RIA.
placanthèra Hook. flat-anthered ✨ ⊠| cu ½ ... G.Y.Pk Brazil 1831? D p.r.w Bot. mag. 3173

A newly introduced and well marked species, from the rich collection of Mrs. Arnold Harrison, who received it from her brother in Brazil; and cultivates it, and the *Orchideæ* generally, very successfully. (*Bot. Mag.*, Aug.) The time of its introduction to, and period of its blooming in, England, are not stated: definiteness in these little matters seems unwelcome to the editors of the botanical periodicals.

gráccilis B.C. slender ✨ ⊠| pr ½ au R.Y Brazil ... D p.r.w Bot. cab. 1837

This curious little plant is very slender in habit, and must be constantly kept in the stove. It may sometimes be separated for increase, and should be potted in moss, vegetable earth, and small pieces of broken pots. (*Bot. Cab.*, Aug.)

2569. ANGRÆ' CUM. (An alteration of *angurek*, the Malayan name of such plants.)
†22793a ebúrneum Thous. ivory-tipped ✨ ⊠| or 1½ n.ja G.W Madagas. 1826. D p.r.w Bot. reg. 1522

This species is in our *Additional Supplement*, but, with its descriptive particulars, less perfect than as here exhibited. But one plant is known to

exist in Europe; and this is in the Horticultural Society's collection, where it flowered for the first time in November last, and continued in beauty for nearly two months. It grows slowly, and has not yet afforded the means of being propagated. Professor Lindley appends to this article the characters of five new genera; and one of these (*Ceœclades*) is to receive certain species hitherto referred to *Augræacum*, among which are the *A. maculatum* and *A. falcatum* of our *Hortus Britannicus*, p. 373. *Ceœclades* is probably from *οἰκὸς* to inhabit, and *kladus*, a branch; from its habit.

Oncidium bifolium is figured in the *Botanical Cabinet* for September, t. 1845.; and of it Messrs. Loddiges remark:—"We scarcely know a plant, even in this favoured class, more elegant in form, or more brilliant in colour, than this; its dazzling brightness is absolutely inimitable."

CCLI. *Liliæcæ.*

1017. *TULIPÆ.*

8426a *malœolens Bert.* ill-smelling ♂ Δ or 1 my R.Y Italy? 1827? O co Sw.fl.gar.2.s.153.
2 *variegata Swt.* variegated *ftwd.* ♂ Δ or 1 my R.Va Italy? 1827? O co Sw.fl.gar.2.s.153

These kinds are not unornamental, and require the same treatment as other tulips: they are figured from the Chelsea botanic garden. (*Flower-Garden*, Aug.)

A second edition of Loudon's *Hortus Britannicus* having been published since our last Number was issued, the present will be a fit time and place to register this fact; and to state that the *second edition* differs from the *first*, in being freed from the principal of the errors which had been observed in the first; in having the just published *Additional Supplement* appended to it, in relation to which new asterisks have been inserted into the body of the book; and in having the price of the *Additional Supplement*, namely, 2s. 6d., added to the price of the first edition; making the price of the *second edition* 1l. 3s. 6d. The *Additional Supplement*, consisting of 24 pages, is also purchasable separately for 2s. 6d. The genera in the *Additional Supplement* are arranged alphabetically, to avoid the necessity of an index to it.

As observed in the preface to our second edition, "whoever wishes to ascertain the additions and improvements made subsequently to the last *Additional Supplement* may consult the *Gardener's Magazine*; in which, under the article which will be henceforth contained in every Number, entitled 'Floricultural and Botanical Notices of New Plants, and of Old Plants of interest, supplementary to the latest Editions of the *Encyclopædia of Plants*, and of the *Hortus Britannicus*,' will be found the name of every plant newly introduced or [striking hybrid or variety] originated, and of every recent improvement in botanical nomenclature."

Obediently to this appointment, we have deemed it pardonable to occupy in the present article a little additional space, for the sake of gathering together, and here exhibiting, all the additions which have accumulated since the putting of the *Additional Supplement* to press, so that the possessors of the *Additional Supplement* will not have to turn farther back in the *Gardener's Magazine* than to the following list, which includes all the newly introduced or originated plants published in the botanical periodicals up to September 1. 1832, and, consequently, includes the names of those noticed in detail in the foregoing pages of the present Number.

An asterisk (*) prefixed to a generic name indicates that name to have never yet been admitted into either the *Hortus Britannicus* or the *Additional Supplement*.

A dagger (†) prefixed to a few specific names signifies that these names are already in the *Hortus Britannicus* or the *Additional Supplement*,

but with the descriptive details of the species these names represent less accurately given than as here presented.

A section (§) indicates a new name devised for a plant already in the *Hortus Britannicus* or *Additional Supplement* by some other name.

2837. *ACA'CIA*. § *Julibrissine*.
 pentadènia *Lindl.* 5-glanded $\text{☉} \square$ or 5 ap Y N.Holl.s.w.c1830. C p Bot. reg. 1521
2487. *A'CERAS*.
 22515a *secundiflora Lindl.* one-sidedspiked $\text{☉} \triangle$ cu $\frac{3}{4}$ ap D.I.V.S Europe 1829? D l.p Bot. reg. 1525
605. *ADENO'PHORA*.
 14925 *verticillata Fis.* whorled-*lvd* $\text{☉} \triangle$ or $2\frac{1}{2}$ jl L.B Siberia 1783. D s.l Sw.fl.gar.2. s.160
Campánula verticillata W. C. tetraphylla Thun.
- *933a *A'JAX* Sal. (*Narcissus L.*)
 álbiancs *Haw.* whitish $\text{☉} \triangle$ or 1 ap W Spain ... O s.l Sw.fl.gar.2.s.145
979. *ALSTRÖME'RIA*.
 8044a *hamántha R. & P.* blood-col.-fld. $\text{☉} \square$ or $2\frac{1}{2}$ jl Dp.O.R Chile 1830. O l.s p Sw.fl.gar.2.s.159
2569. *ANGRÆ'CUM*.
 128612a *ebúrneum Thou.* ivory-tipped $\text{☉} \square$ or $1\frac{1}{2}$ n.ja G.W Madagas. 1826. D p.r.w Bot. reg. 1522
1345. *A'RBUS*.
 11079b *pihsa Grah.* hairy-branched $\text{☉} \text{II}$ cu $\frac{1}{2}$ my W Mexico 1829? L l.p Bot. mag. 3177
1061. *ASPHO'DELUS* 8869 *luteus*
 2 *sibiricus Lindl.* Siberian $\text{☉} \triangle$ or 2 ap.myPa.Y Siberia 1829? D co Bot. reg. 1507
957. *BILLBE'RGIA*
 7752a *bicolor B. C.* two-coloured $\text{☉} \square$ or $\frac{3}{4}$... Ro.B RioJan. 1829? Sk s.p Bot. cab. 1819
65. *CALCEOLA'RIA*.
 27995a *péndula Swt.* pendulous-*flwd.* $\text{☉} \triangle$ or $1\frac{1}{2}$ su Y.spot Chiloe 1831. S p.l Sw.fl.gar.2.s.155
- +3436a *CAMA'SSIA* *Lindl.* (*Quamash* or *Cumas*, native name in N.W.America) 6.l. *Asphodélea*. 1—
 128707 *esculenta Lindl.* esculent $\text{☉} \triangle$ or $1\frac{1}{2}$ jl D.P Columbia 1827. O p Bot. reg. 1486
 M. Rafinesque, as early as 1817, had named this plant *Quamássa* *esculenta*. See his *Medical Flora*, vol. ii. p. 255.
2038. *CAME'LLIA* 18166 *japónica*
Reevesiana Lindl. Reeves's $\text{☉} \square$ epl 10 sp C.Wsh China 1829? 1 l.p Bot. reg. 1501
 var. *compacta B. C.* compact-*flwd.* $\text{☉} \square$ or 4 n.f W Eng.sdlg. ... I l.p Bot. cab. 1836
1246. *CHORO ZEMA*. (*Choros*, dance, and *zema*, drink; circumstances of its discovery.)
 10499a *triangulæ Lindl.* 3-angledprickled $\text{☉} \square$ or $\frac{3}{4}$ ap S N.Holl 1830. C s.p Bot. reg. 1513
 10500a *ovátum Lindl.* ovate-*lvd.* $\text{☉} \square$ el 1 my S N.Holl. 1830. C s.p Bot. reg. 1528
1185. *CLA'RKIA* 10047 *puleiella*
 2 *fibre-álbo Swt.* white-*flwd.* \circ or $1\frac{1}{2}$ jn W N.Amer. 1826. S co Sw.fl.gar.2.s.157
- 3333 *COBU'RGIA*.
 28152a *fálva Herb.* tawny-*flwd.* $\text{☉} \triangle$ or 1 f. Taw S.Amer. 1829? O l.r.m Bot. reg. 1497
3383. *CO'LEUS*.
aromáticus Benth. aromatic $\text{☉} \square$ fra $1\frac{1}{2}$ mr.myPa.V India 1826. C p.l Bot. reg. 1520
Côleus amboínicus Lour., Gesnèria odorata Hort.
563. *CO'RDIA*.
 1 grandiflora *Lindl.* large-*flwd.* $\text{☉} \square$ or ... au W S.Amer.? 1827. C l.p Bot. reg. 1491
1257. *DILLWY'NIA?*
glycinifolia Sm. Glycine-*lvd.* $\text{☉} \square$ el $1\frac{1}{2}$ a O.Ro S.W.N.Holl.1830. S s.p Bot. reg. 1514
504. *E'PACRIS*.
variabilis B. C. variable $\text{☉} \square$ or 2 ja.f Pk N.S.W. 1829. C s.p Bot. cab. 1816
nivális B. C. snowy-*flwd.* $\text{☉} \square$ or 3 mr W N.Holl. 1829. C s.p Bot. cab. 1829
2554. *EPIDENDRUM*.
variegátum Hook. vari. *lvd. & flwd.* $\text{☉} \square$ or 1 ja Ysh.g.spotP RioJan.1830. D p.r.w Bot. mag. 3151
61. *ERA'NTHENUM*.
fecúndum Lindl. ever-blowing $\text{☉} \square$ or $1\frac{1}{2}$ all sea Li Brazil 1829? C p.l Bot. reg. 1494
4173. *ERI'CA*.
 § 1. *Tubiflora*.
dichrómata B. C. two-coloured $\text{☉} \square$ or 3 aut.wY.Pk C.G.H. 1800. C s.p Bot. cab. 1813
verecúnda B. C. ruddy-*flwd.* $\text{☉} \square$ or 3 su.aut Ro C.G.H. 1820. C s.p Bot. cab. 1827
 § VI. *Ovatiflora*.
 9800a? *villosúscula B. C.* slightly villose $\text{☉} \square$ or $1\frac{1}{2}$ my Li C.G.H. 1829? C s.p Bot. cab. 1844
1311. *ERIOSTE'MON*.
 10930 *myoporóides Dec.* Myoporum-like $\text{☉} \square$ or 3 sp W N.Holl. 1823. C s.p.l Bot. mag. 3180
2268. *EUPATO'RIMUM*.
 120524a *Ayapána Ven.?* Ayapana $\text{☉} \square$ m 3? au.o Li.R Brazil 1821. C It.l Ven. mal. 3.3
937. *EU'RYCLES*.
 128863 *Cunninghãmi Lindl.* Cunningham's $\text{☉} \triangle$ el 1 mr.ap W N.Holl. 1830. O p.l Bot. reg. 1506
3450. *FRANCO'A*.
 128869. *appendiculata Cav.* appendicled $\text{☉} \triangle$ or 3 my jn Ro.C Chiloe 1831. S p.l Sw.fl.gar.2.s.151
1188. *FU'CHSIA*.
 10075a *globosa Hort.* globose-*flwd.* $\text{☉} \square$ or 5 jn.s C.P Eng.hyb.? 1830. C pl. G.M.viii. p. 598

316. GREVILLEA.
 2626a canescens R.Br. hoary-lvd. $\text{■} \square$ cu 5 ... G.TawPortJack.1824. C s p Bot. mag. 3185
 †28900 robusta Cunn. robust or silk oak $\text{■} \square$ or 80 ... O MoretonB.1830. C l p Bot. mag. 3184
 †28899 Calcey R.Br. Calcey's $\text{■} \square$ or 5 jn.s R PortJack.1829. C p l Bot. mag. 3133
blechnifolia Cunn. MSS. Blechnum-leaved.
2490. HERMNIUM. [3164
cordatum Lindl. heart-lvd. $\text{y} \triangle$ fra $\frac{2}{3}$ mr.n Ysh.G N.W.Af.S.W.Eu.1830. D p.l Bot mag.
Habenaria cordata Hooker Bot. mag. 3164, and of the *Additional Supplement*, No. 28904.
1597. HIBBERTIA.
 14115a Cunninghamii Ait. Cunningham's $\text{■} \square$ or 2 jn Y Kg.G.'s.Sd.1823? C s p Bot. mag. 3183
 It is possible, but we know not if probable, that this is the No. 28922. of the *Additional Supplement*.
2014. HIBISCUS.
 17292a Genèvei Boj. Genève's $\text{■} \square$ spl. 15 jn.jl Ro Mauritius ... C l p Bot. mag. 3144
1940. HOVEA.
 17284a villosa Lindl. shaggy $\text{■} \square$ el 3 ap Li N.Holl. 1829? C s p Bot. reg. 1512
142. IRIS. $\frac{1}{2}$ The spreading segments of the perianth beardless.
nerchinskia Fis. Nerchinsk $\text{y} \triangle$ or $\frac{2}{3}$ my B Siberia 1831. D r Bot. cab. 1843
 1305a longifolia Swt. long-leaved $\text{y} \triangle$ or $\frac{2}{3}$ ap P.Gsh Naples 1829. D lt Sw.fl.gar.2.s.146
1471. MAMMILLARIA.
tenuis Dec. slender $\text{■} \square$ gr $\frac{1}{2}$ my Pa.Y ... 1830. O ru Bot. reg. 1523
 Mentioned in the *Additional Supplement* under Mammillaria, p. 593.
2537. MAXILLARIA.
picta Hook. painted-flwd. $\text{f} \square$ or $\frac{1}{2}$ d O spot OrganMtns.1830?D p.r.wBot. mag. 3154
viridis Lindl. green-scaped $\text{f} \square$ cu $\frac{1}{2}$ my G.P.Li RioJan. 1829? D p.r.wBot. reg. 1510
placanthera Hook. flat-anthered $\text{f} \square$ cu $\frac{1}{2}$... G.Y.Pk Brazil 1831? D p.r.wBot. mag. 3173
gracilis B.C. slender $\text{f} \square$ pr $\frac{1}{2}$ au R.Y. Brazil ... D p.r.wBot. cab. 1837
1177. MICHAUZIA.
 †9951. lavigata Ven. smooth $\text{f} \triangle$ or 11 au.o W N.Persia 1820. S r.l Bot. mag. 3123
- *2569a CECEOCLADES Lindl. (Probably *aikco*, to inhabit, *kladus*, a branch.) 21.1. *Orchidæ*, Sp. 10—
 †2791 maculata Lindl. spotted $\text{f} \square$ pr 1 o.n Pk Africa 1819. D p.r.wLindl. col. 15
Angræcum maculatum Lindl. Bot. reg. 618, Hort. Brit. No. 22791.
 †22792 falcata Lindl. falcate $\text{f} \square$ pr $\frac{1}{2}$ n.d W China 1815. D p.r.wBot. mag. 2097
Angræcum falcatum Lindl., Hort. Brit. No. 22792.
1053. ORNITHOGALUM.
bifolium B.C. two-leaved $\text{y} \triangle$ cu $\frac{1}{2}$ au W Chile 1831. O s.l Bot. cab. 1802
alliaceum B.C. Allium-like $\text{y} \triangle$ or $\frac{1}{2}$ au W Chile 1821. O s.l Bot. cab. 1818
1596. PÆONIA 14098 officinalis
 7 anemoniflora Hook. Anemone-flwd. $\text{y} \square$ or 3 my.jn R ... 1830? D s.l Bot. mag. 3175
- *2558a PIIAJUS.
 †2760 maculatus B.C. spotted-lvd. $\text{f} \square$ or 2 ja.jn Y Nepal 1823. D p.r.wBot. cab. 1803
Bletia Woodfordia Hort. Brit. No. 22760.
679. PITTOSPORUM.
 †29128. cornifolium Cunn. Dogwood-lvd. $\text{■} \square$ cu 3 mr Br N.Zeal 1827. C p Bot. mag. 3161
1210. POLYGONUM.
 †10274 adpressum R.B. appressed-styled $\text{■} \square$ cu 60 my.au W N.Holl. 1822. L l p Bot. mag. 3145
2518. PTEROSTYLIS. $\frac{1}{2}$ Stems leafy, appendix of labellum pencilled at top.
Banksii R. Br. Banks's $\text{y} \triangle$ cu 1 $\frac{1}{2}$ d Y.W N.Zeal. 1826. D p.l Bot. mag. 3172
719. RIBES.
 5928a speciosum Ph. showy $\text{■} \square$ or 5 my.jn C California1829. C co Sw.fl.gar.2.s.149
stamineum Smith in Rees's *Cyclop.* and Dec. in *Prod.* 3. 477., and also *speciosum* Dec. in *Prod.* 3. 478.
1339. RHODODENDRON.
 11069a Smithii Swt. Smith's hybrid $\text{■} \square$ spl. 8 sp C Arboreo.pont 1826. L l p. Sw.fl.gar.2.s.50
 (Obtained from seeds of *R. ponticum*, imbued with the pollen of *R. arboreum*.
pulechrum Swt. Smith's beautiful $\text{■} \square$ or 3 ap.jl Ro. Eng hybrid1827. C s p Sw.fl.gar.2.s.117
R. indicum γ Smithii Sweet's *Hort. Brit.* ed. 2. p. 343., and *Azalea indica* γ Smithii of some others;
 and is from seeds of *A. ledifolia* Hook. impregnated with the pollen of the original *A. indica*.
 This last remark is, in the *Additional Supplement*, wrongly placed under *R. Smithii* and not under *R. pulechrum*, to which it relates: *R. Smithii* Swt. is a modification of *R. ponticum* L., and *R. pulechrum* Swt. a modification of *Azalea indica*, as is the following:—
indicum Swt.
 2 *Smithii* Swt. Smith's hybrid $\text{■} \square$ or 3 ap.jl. Ro.Sal Phœn.ind.1828. C. s.p. Sw.fl.gar.2.s.154
 This and *R. pulechrum* are, according to the figures, quite distinct objects, but under *R. pulechrum*, in the *Flow. Gard.*, is cited as a synonyme *R. indicum* γ Smithii Sw. *Hort. Brit.* ed. 2. p. 343.; consequently, if this synonyme is wrongly cited, or the *R. indicum* γ Smithii of Sw. *Hort. Brit.*, and the *R. indicum* var. *Smithii* of the *Flow. Gard.* 154., relate to two distinct plants.
1522. ROSA 13470 indica
 var. *Smithii* Swt. Smith's *yel.* Noisette $\text{■} \square$ or 5 sp.su Y Eng.hyb. 1829. C r.l Sw.fl.gar.2.s.158
2023. STIDA. $\frac{1}{2}$ 111. Heart-leaved.
aurea B.C. golden-flwd. $\text{■} \square$ or ... my.jl O.R India 1830? C l p Bot. cab. 1842
3311. SOULANGIA.
 5365a rubra Lindl. red-flwd. $\text{■} \square$ or 3 d R C.G.H. 1827? C p.l Bot. reg. 1498
3294. SIPHONOTOMA. (Prof. Lindley supposes in expression of the wedge-shaped segments of the corolla.)
 capitatum R.Br. head-spiked $\text{■} \square$ or 1 ap.my W N.H.s.w. 1830. C turf.pBot. reg. 1515
 † *Dracopisium capitatum*, *Additional Supplement*, No. 28818., and *Loddiges's Bot. Cab.*, Sept. 1832.

1925. <i>TACSONIA</i> .																			
+28452	<i>pinnatistipula J.</i>	pinnate-stip.	▲ □	or 30	sp	Pa.Ro	Chile	1828.	C	p.l	Sw.fl.gar.2.s.156								
2037.	<i>THEA</i> 18160	<i>viridis</i>																	
	2 <i>latifolia B. C.</i>	broad-leaved	▲ □	or 4	f.n	W	China	1825?	C	p.l	Bot. cab. 1828								
1000.	<i>TRADESCANTIA</i> .																		
+29296	<i>congata Penny</i>	crowded	▲ △	or 2	jl.o	B	N.Amer.	1826.	D	co	Maund's bot.								
123.	<i>TRITONIA</i> .																		
	<i>odorata B. C.</i>	fragrant	♂ ▲	or ½	su	Y	C.G.H.	1829?	O	s p	Bot. cab. 1820								
1148.	<i>TROPÆOLUM</i> .																		
+28188a	<i>brachyceras Hook.</i>	short-horned	▲ ♀ ▲	or 2	Chile	1828.	C	l.p	Hook. bot.								
1017.	<i>TU'LIPA</i> .																		
8426a	<i>malæolens Bert.</i>	ill-smelling	♂ ▲	or 1	my	R.Y	Italy?	1827?	O	co	Sw.fl.gar.2.s.153								
	2 <i>variegata Swt.</i>	variegated-fl.	♂ ▲	or 1	my	R.Va	Italy?	1827?	O	co	Sw.fl.gar.2.s.153								

In the *Additional Supplement*, Nos. 28650. and 28796. are superfluous, being applied to synonymes, and not to species.

. Besides looking forward to a future Supplement to our *Hortus Britannicus*, we are about to commence *A Supplement to the Encyclopædia of Plants*; and, as we are desirous of the accuracy and completeness of both the *Hortus* and the *Encyclopædia*, we shall thankfully receive and acknowledge all corrections and all additions to them with which any one may please to favour us.

ART. III. *Retrospective Criticism.*

CORRECTIONS to the June Number, p. 257—384. In Mr. Main's article "On pruning Forest Trees," fig. 51. p. 310. is exhibited bottom upwards. In p. 325. line 10. for "Rev. George Jennings" read "Rev. L. Jenyns." In p. 351. line 3. from the bottom, for "Phægus" read "Phæjus." In p. 381. line 7. from the bottom, for "albumen" read "alburnum."

In Mr. Rivers's Tour, p. 393. line 5. for "edges" read "hedges." *Fuchsia bacillaris* Lindl. and *Fuchsia globosa* Hort. are not identical, as they are stated to be, p. 505., but widely distinct: see p. 598. — *J. D.*

Cratægus Oxyacantha rosea superba is (see p. 505.) the name, in the Horticultural Society's garden, for the splendid variety of hawthorn described p. 362. Is it distinct from the *Cratægus Oxyacantha punicea* of Loddiges' *Botanical Cabinet*, t. 1363.? — *J. D.*

Bretton Hall. — Sir, In looking over the June Number of your Magazine, I perceive, under the head of "Domestic Notices: — England," p. 361., you have informed your readers that "the hot-houses at Bretton Hall, including the magnificent dome figured in Vol. V. p. 681., and all the plants, with the museum, and many other articles, the property of the late munificent patroness of gardening and botany, Mrs. Beaumont, have lately been brought to the hammer, and sold for a mere trifle." A statement so general and unqualified, at the present moment, together with the numerous advertisements and flaming descriptions by the eloquent Mr. Robins, which appeared in the public prints previously to the sale, are all highly calculated to confirm an impression which is already very prevalent in the country, viz., that the whole of the hot-houses and plants have been sold, without reserve. So far from that being the case, I beg to inform you that there are hot-houses left, and others now building, equal to supply the wants of even an extravagant family, should that be required. And when I tell you that, in addition to the "massy stone-built conservatory" noticed in another part of your Magazine, there are, a splendid orangery, a heath-house, and a plant-stove, now building, it can hardly be believed that "all the plants" have been sold. The two latter will be equal in extent to the green-house and plant-stove of the Count de Vandes, at Bayswater. I also beg to say, that I have authority for stating that the gardens will still continue to be supported in the most creditable manner.

In the statement above alluded to, you have referred to Vol. V. p. 681.

to a description which you have given there of this place. I am not, at present, at liberty to give any detailed account of the extensive and sweeping alterations now going on; and must therefore confine myself to the notice of one or two mistakes into which you have fallen; mistakes which, but for reasons not now worthy of notice, would long since have been corrected. In the first place, it is perhaps only fair to state that the time you devoted to the inspection of the garden and grounds was exceedingly limited; and some considerable misrepresentations have been the consequence. In describing the situation on which the house has been built, you say, "The grand misfortune is, that there is no natural marked situation for the house." Without mentioning that the situation on which the house stands is the most appropriate that could have been chosen, I am still very doubtful whether a more eligible site could have been selected, at least within some miles of the present; and I do think, had time permitted you to walk round the south and east fronts, the impressions produced upon your mind would have been somewhat different. With regard to your prediction, that at some future time the house would be built at the top of the valley, I can only say, that, had you ever seen the ground, or were you at all acquainted with the geography of the place, you would not for a moment have entertained such an idea.

In allusion to the bank on which the house is placed, you also say, "as this bank is confronted by another of similar character rising from the narrow bottom of the same streamless valley," &c. Now the fact is, that this valley has at least 70 acres of its surface continually covered with water; and the stream, which is at all times passing through it, is found sufficient, even during the driest seasons, to work several flour mills a little beyond the boundary of the park, which are never at a loss for water, although entirely dependent upon this stream for their supply. Again, a little farther on, you have said, "As this valley, and consequently its banks, lie in a direction more or less south and north, the hot-houses are, in order that they may front the sun, obliged to be built across the slope." Instead of the valley and banks lying north and south, they lie due east and west; the one bank sloping from the south, and the other from the north. On this latter bank are situated the gardens and hot-houses; but why you should designate them "inharmonious," because built across the slope, I am at a loss to know. The meaning which I thought the words "slope" and "across" were generally intended to convey, when used with reference to a sloping bank, or an inclined plane, was, to suppose a line drawn from the bottom to the summit of a sloping bank, and, at any given point between the higher and lower ends, to suppose another drawn at right angles with the first. This would exactly correspond with the idea which I had entertained of an object of greater length than breadth, when placed across a slope; and would also represent the relative position of our forcing-houses, which, it is needless to add, are all built across the slope, with their fronts due south. As it will, to a certain extent, account for some of the mistakes into which you have fallen, it may be also proper to state, that, at the time you visited the place, three large span-roofed pine-stoves were standing in a line with the slope; their ends pointing north and south, the effect of which, it cannot be denied, was very inharmonious: but at the time you called, a part of them was being demolished, in order to give place to others then building; and, from the arrangements at that time in progress, it was evident that their entire removal was shortly intended. The coach road, which you have justly termed pitiable, is now transformed into quite a new line. — *Robert Marnock. Britton Hall Gardens, July 14 1832.*

Cow Cabbage, as described by a Fricul of Mr. Murray, Vol. V. p. 65. — Sir, Having seen, some time ago, in your Magazine, an account of the

extraordinary produce of the cow or tree cabbage; and being very desirous to get rich in a little time, I set about calculating how many cows I could keep upon it, on my farm, which contains near 100 acres; and I found I could keep from 10,000 to 12,000. I also calculated that these cows would give sufficient milk to supply Manchester and Liverpool with this fluid, and perhaps a few other towns in the neighbourhood; at least, if it fell short, I could adopt the Scotch and also the London plan of mixing a little water with it. Having made these calculations, and finding the great profits arising from the cultivation of this vegetable, I determined to give up my old jog-trot habits, and to dash into money-getting at once. Fearing some other farmer would take the hint before me, I, without further delay, set off to Liverpool, and contracted with all the milkmen in the town to supply them with all the milk they could sell, at a farthing a quart less than they could get it from the farmer at present. I then did the same at Manchester. Now, I calculated that in two years my cabbages would get too tall to get the produce of them without the help of ladders: I therefore determined to adopt the following plan:—to renew one half of my farm every year with fresh plants; consequently, I should have about 160,000 cabbage stumps to take up every year. Now, your Magazine said that the stumps of these cabbages would make excellent rafters for buildings; I therefore contracted with the house-carpenters in Manchester and Liverpool to supply them with 160,000 rafters every year, at 1s. each, and found that I should thus make 8000*l.* each year of my cabbage stumps. I then contracted with these carpenters to build me cow-houses for 12,000 cows; one half to be paid in ready money, and the other half in cabbage stumps at the above price. Last year I got my cow-houses built, and my land fallowed, manured, and planted, ready to overflow the land with milk. But alas! alas! how must I describe my disappointment, when I find, by experience, that these cabbages will produce no more food, from an acre, than red clover; a plant which I had a little time before despised and driven from my farm! I am now a ruined man, beset with duns on every side; while the milksellers and carpenters declare that they are determined to make me fulfil my contracts with them, of supplying the former with milk, and the latter with cabbage stumps.

Now, Sir, I wish to know whether I cannot recover damages, either of you or the author of those articles on this ruin-creating plant. But whether I can do this or not, I hope you will publish this in your Magazine, as a warning to all such simple fools as myself, who believe all which is written on farming and gardening. I forgot to tell you, in its proper place, that I at last sold my cow-houses, for one fourth of their cost, to a gentleman who has converted them into cottages, and who has given the place the name of Cabbage Town. I am, Sir, your's, &c. — *A disappointed Lancashire Farmer. Cabbage Town, May 1. 1832.*

ART. IV. *Queries and Answers.*

HEATING Water by the Sun's Rays.— I have tried the experiment you alluded to (Vol. III. p. 101.), of heating water by the sun's rays, through a circulation produced by a siphon. My siphon (*fig.* 122.) was blackened at the ball side, and white at the other. The ball was six times the diameter of the tube, which was about 1 in. in diameter. It was applied to heat a tub, containing a plant of *Nelumbium speciosum*, in a dry stove. The tub contained, exclusive of the earth, about 10 gallons of water; and during the hottest days of last month it never increased the temperature of the water more than 7° above that of a similar vessel placed in the same part of the stove, but without a siphon. The siphon had the full sun on

122

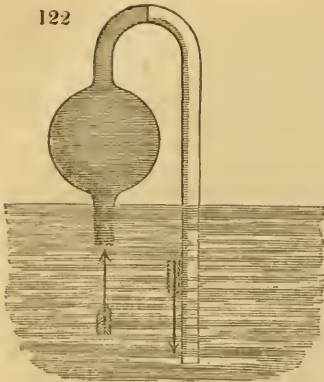

it, and was within 2 ft. of the glass. There was considerable circulation in the tube, as was evidenced by observing the animalcules drawn into the tube at one end and expelled at the other. This experiment was on a small scale; but I fear it is sufficient to show that by this method no material increase of heat can be obtained from the sun's rays. — *R. Mallet. Dublin, July, 1832.*

The White-flowered Everlasting Pea. — Sir, G. C.'s remarks on *Láthyris grandiflorus* (p. 50.) remind me of a circumstance, which I have observed several seasons, with respect to the everlasting white pea. I have some plants which grow most luxuriantly, and

produce a profusion of fine bloom, with apparently perfect pods: but I have always found the seed small and withered, and it has never vegetated; although I have had from the *Láthyris latifolius*, which is growing close to it, a quantity of good seed. Perhaps some of your readers will be able to state whether they have succeeded in raising any seedlings, and also if the plants so raised have always produced the white flower? Is this pea a seminal variety of the common everlasting pea? It has, within these few years, been considered scarce; yet, I have been told, it was known many years ago. If this is really the fact, it would be curious to trace its origin; and as it is a plant not easily killed, or likely to be despised or neglected, how was it lost for so many years to our gardens, and to whom, or to what chance, are we indebted for its resuscitation? It is, doubtless, a most delicate and lovely flower, being of the purest white, and deserves to have a place in every flower-garden. Has it been figured in any botanical work, or noticed in any catalogue? I am, Sir; yours, &c. — *E. London. Feb. 13. 1832.* [In Sweet's *Hort. Brit.* and the *Sup.* to our own.]

The Chelsea Apple-powder. — Do you happen to know a little work called *The Fruit-Grower's Instructor*, by G. Bliss? I procured it when last in town; and my reason for asking the question is this; it professes to recommend, in very high terms, "the Chelsea apple-powder," the invention, as it is stated, of the said Bliss. Is the book authentic, and is the powder worth trying? Perhaps you can ask this question in the *Gardener's Magazine*, where some kind Christian in the apple line may take compassion on it. I am unfortunately plagued with this tree cholera (the canker), and therefore lay my case before you, as president of the Pomological Board of Health. My trees are all of the dwarf sorts; the soil a gravelly loam upon a chalk bottom; not a very congenial one for an orchard, but there it is, and I must make the best of it. My gardener tells me this Chelsea powder is a hum, which is as bad as a bug (I am not sure if he did not use the compound word; the compound certainly, *per se*, he has used), and, though inclined to the Roman, turns up his nose thereat. He, of course, does not give his countenance to Bliss, being, moreover, a very plain [dealing] man. — *S. T. Stokeferry, June, 1832.*

Shustoke Pippin Apples. — I send specimens of a kind of apple, which, I believe, is the Shustoke pippin. (Shustoke is a village in Warwickshire, rather famous for its apples.) It does not pretend to be any thing more than a kitchen apple; but is worth growing for its size and keeping: it will make, as you may see, a very decent tart or roasted apple now in June, or later. Is it known about London? — *W. T. Bree. Allesley Rectory, June 6. 1832.*

We took one of the apples to Mr. Ronalds of Brentford, who had not before heard the name, and who did not know the apple, though he thought it an excellent one. The other apple we have kept, and it is still (July 7.) in excellent preservation. — *Cond.*

Can a Vinery be forced from the 1st of January, with the certainty of a good crop, under the following disadvantages? The length of the house is 27 ft., breadth 18 ft., with one fire, the flue of which is in front, and passes close by the stems and roots of the vines once round the house. The vines are planted partly inside partly outside, in very light soil, and, I believe, are through to the subsoil, which is little better than sand. From the intervention of a large dwelling-house, and a wall 14 ft. high, close in front of the vinery, I may say the sun does not shine on it for the first month in the year: in the second (Feb.), it receives between three and four hours' sunshine in the middle of the day; but the border in front receives it only as the season advances: the house receives very little more sun, as the wall in front, even in summer, has always some shadow. Yours, &c. — *A Correspondent. St. Andrew's, March 3. 1832.*

Some delicious Wild White and Red Berries, not unlike small grapes, and ripe about the middle of August, are mentioned in Jones's Travels in Norway, Sweden, &c., as growing on the banks of the river Langen, in Norway. What are they? — *A. X. Feb. 8. 1832.*

Insects infesting Cucumbers. — I herewith enclose you a few insects which have dropped, as it were, like rain upon my forcing ground, and which seem inclined to claim all in and all out of the frames as their own, bidding defiance to every expedient I can think of to get rid of them. If you or any your readers can give me any information respecting these insects, I shall feel very greatly obliged. As far as I can describe them, they are a kind of caterpillars, concealed under a fine web, on both the upper and under sides of the leaves. They are green at first, afterwards changing to black; and the cucumber plants attacked by them seem at once to stop in their growth, producing fruit scarcely fit to be seen. On other plants these insects appear to act like those caterpillars which eat through rosebuds; they have attacked some georgina cuttings in my frames, beginning at the top of the cutting, and making separate holes, or rather tubes, down to the root. Though these insects generally conceal themselves under a web, they are sometimes found on small leaves, the edges of which they have caused to curl over them. They are very destructive, and scarcely any thing in my garden has entirely escaped their ravages. — *R. T. May 3. 1832.*

We saw nothing in the letter but a few green and yellowish stains, and conclude that the insects must either have escaped, or been crushed into fluid. — *Cond.*

Mr. Oliver's Cross of the Cucumber with the Maltese Melon (Vol. IV. p. 514., Vol. VI. p. 502. and 727., and Vol. VII. p. 87. 622. and 718.). — Sir, I beg to inform your correspondent J. C. K. of Levant Lodge (Vol. VII. p. 720.), that my cross of the cucumber with the Maltese melon was obtained in the following manner: — I have for many years been in the habit of making a late melon-bed, on which I put three plants, under a hand-light, the hand-lights being placed 4 ft. apart. As soon as the hand-lights are full, I take the cucumber-frames which were first put to work in January and February, and place them over the melons; and, by so doing, seldom fail of getting a good crop in September and October. In performing this operation in the year in which I obtained the hybrid, it so happened that I had not plants enough by one pot to fill up my bed; but had plenty of a long sort of cucumber that I had previously grown, but more to look at than for use, except for mangoes, &c. &c. Soon after the fruit began to swell, I observed several of them very unlike the others; they got very

large at the end, and by no means long like the other fruit in the same light. I immediately thought they had been impregnated with the Maltese melon growing in the same frame, and marked one of them for seed. I made choice of one that was largest at the end, and had most of the appearance of the melon: this was, I think, either in 1824 or 1825. As I never sow new cucumber or melon seed, if I can help it, the seeds of the hybrid were put by with the other seeds of the cucurbitaceous tribe. In the spring of 1828, the pot containing the seeds of the hybrid came in its turn with the others that were sown for the hand-light ridge, and two pots were put out for a two-light frame. Not one of the fruits or the leaves partook of the cucumber in length or in smell (when ripe), but very much so in flavour; consequently, no one that tasted them liked them: and as I found them as much trouble as a frame of melons, and much inclined to sport, I did not trouble myself to grow any more. I cut up many of the fruits, but not one seed did I find that was likely to grow; and this, most likely, was also the case with those that I sent (three) to the Horticultural Society of London, as Mr. Sabine wrote to me to send him a few seeds. Two of the fruit I sent to Lady Craven, Hamstead Lodge, near Newbury; and I believe there was no seed in them also. Should, however, J. C. K. like to try some of the old seed of the first cross, I think I can find a few, to which he shall be welcome; but I think it not unlikely that they are too old to grow. In exchange, I shall be thankful for a seed or two of the Regent and Wellington melon, if J. C. K. has them to spare.

I have to inform J. C. K. that mine was not the first cross of the cucumber and melon I had seen; for, some years back, I think near thirty, calling on J. Harrison, Esq., at Brompton, while I was with him, a gardener of his acquaintance called on him with a very handsome fruit (a cross) for his inspection; and I well remember it was very much like the one I first saved for seed.

I have my doubts of the hybrid fruit of any sort ever producing seeds that will grow. The cross with the pink and sweetwilliam will not seed; but the sweetwilliam will sport with the pink in colours, and bring a single flower that will seed like itself, but will not sport again, so far as I can find. In the bird family, I have tried, for three years, to effect a cross with the Muscovy drake and the English duck. Their produce was very fine and good, but the eggs of the mules never brought a bird, either under ducks or hens; and although one sat well for seven weeks, it was all to no purpose. The mules resulting from crossing the horse and the ass do not breed, &c. &c. I am, Sir, yours, &c. — *J. Oliver, C.M.H.S. Combe, Feb. 27. 1832.*

In Vol. VII. p. 696., some facts are recorded which tend to establish a conclusion that hybrid plants are more hardy than the kinds out of which they originated; and J. C. K., at p. 52. of the current volume, assents to the truth of this opinion in application to hybrid melons; but imputes it rather to greater vigour infused into the embryo of the first hybrid than as a constitutional characteristic, which will become hereditary through the successive generations of the hybrid, should the hybrid persist through successive generations (see p. 52.). — *J. D.*

Raising Cucumbers by Steam. — Whose is the best plan, so as to supply the table through the winter? And what is the cost of the apparatus? — *A. X. Feb. 9. 1832.*

We are not aware whose plan is the best: but sufficiently good apparatus have been erected by Neeve, Cottam, Walker, and others mentioned in this Magazine, who will tell the cost on application. — *Cond.*

Portsmouth Broccoli. — Is the superiority of this variety attributable to the soil and situation in the neighbourhood of Portsmouth? It certainly is not owing to any thing very distinct in the sort; for I have grown broccoli several times, both from plants and seeds sent from Portsmouth,

without having ever succeeded in getting it above the ordinary size and quality. Perhaps some of your readers in the neighbourhood of Portsmouth will favour us with some information respecting this kind of broccoli. — *A. N. March 3. 1832.*

Prussian Asparagus. — Seeing in this market abundance of Prussian asparagus, I send you threepence worth, and shall be glad if you will let me know how you like it. I have had some boiled, and placed upon a toast with melted butter; but none of my family admired it, nor do I like it myself. — *W. W. C. Bath, June 5. 1832.*

We had long been curious to know what this Prussian asparagus was, and we now find it to be the flower-spikes, when about 9 in. long, of the *Ornithógalum pyrenàicum L.* This plant is found wild in pastures between Bath and Bradford; between Bath and Warminster; three miles from Bristol, on the way to Bath; near Charleton, in Somersetshire; and half a mile from Chichester, Southgate, in a meadow. It appears to be gathered in the fields, and brought to the market at Bath. There were about a hundred spikes in the bundle sent us by our correspondent: we cannot say that we liked them, though others of our family did; and, indeed, as they appear to be perfectly wholesome, the liking or disliking is a matter of no consequence; for there can be no doubt that habit would render them as agreeable as the cultivated asparagus. Were this the case, there would be a great advantage in cultivating the *Ornithógalum*; because depriving it of the part to be eaten would strengthen the plant, instead of weakening it, as in the case of the common asparagus. As *O. pyrenàicum* is by no means scarce, we hope some of our readers will try what can be done with it. We have no doubt the whole plant may be increased in size by proper cultivation. We are equally clear that the flower-stalks of other species of *Ornithógalum*, such as *O. pyramidàle* and *nùtans*, might be eaten; and the bulbs of *umbellàtum*, it will be recollected, formed the “doves’ dung” of scripture, and have been eaten from time immemorial by the Persians. Probably many of the hexandrous plants, both stalks and roots, might form edible vegetables as agreeable as those which we are now in the practice of cultivating. — *Cond.*

The Culture of the Sweet Potato. — Sir, I beg to second the enquiries of Signor Manetti regarding the culture of the *Convòlvulus Batàtus* in England, and to urge on your correspondents who may be competent thereto, that they will communicate speedily their knowledge on the subject; also that you, on your part, will afford an early insertion to their answers in your Magazine. I have for some time past purposed experimenting on the culture of this plant, but shall be glad to know what has been already done, and where tubers of desirable varieties may be obtained.

Certain Melons grown in Italy. — I have, at the same time, a favour to ask of the Signor Manetti himself; and, should this meet his eye, he will, perhaps, when he is sending to England, gratify a wish I entertain to procure seeds of the undermentioned melons, by forwarding for me, to your care, a few of each. I trust he will continue his highly interesting communications. The melons I am in want of are: the Malamocesini melon, stem 2 or 3 in. thick, and very knobby: the Rampaghini, or climbing melon; and the Bacharian melon. They are all described in p. 448., as grown at Venice. — I am, Sir, yours, &c. *J. C. K. Levant Lodge, Aug. 11. 1832.*

Agricultural Horses fed on Barley. — I have heard, and believe, that there is a practice in Norfolk of feeding agricultural horses on barley which is wetted, and allowed to sprout in heaps. I remember that, some time since, the exchequer attempted to put a stop to this practice, it being deemed dangerous to the malt duty; and that the Norfolk people, at the head of whom was that most venerable agriculturist, Mr. Coke, resisted, and effectually, the exchequer’s attempt. Can you give any detailment of this

practice, and of the regulations under which it is now carried on? A knowledge of it would be very valuable all over the kingdom. If Mr. Coke would condescend to write to you, he could tell you all about it, and so can any of his tenants. — *X. Y.* Sept. 5. 1831.

ART. V. *London Horticultural Society and Garden.*

JULY 17. 1832. — *Exhibited.* Specimens of corn [common wheat], from Mr. Lance of Lewisham, author of *The Golden Farmer*.

From the Garden of the Society. A new species of *Gaura*, from California, and a new species of *Aster*, also from California. *Spiræa arifolia*, and various other flowers. Fruits of three sorts of cherry, red masculine apricot, Elton scarlet strawberry, a collection of gooseberries, and specimens of three fine varieties of Silesian lettuce.

August 7. — *Read.* A paper on the drying of plants for a *Hortus Siccus*, by Dr. Knight, of the Marischal College, Aberdeen. A paper on the advantages of irrigating garden grounds by means of tanks and ponds, by T. A. Knight, Esq.

Exhibited. Noblesse peaches, from William Lindsay. Cucumber and cockscomb, from Mr. Elphinstone, gardener to T. Broadwood, Esq. Garden seat and flower stand, from Mr. Gibson, 2. Little Camera Street, Camera Square, Chelsea. Twenty-four varieties of carnations and picotees, from Mr. T. Hogg, florist, Paddington, of which the following are the names: — Bijou de Clermont, Mademoiselle d'Orléans, Marshal Turenne, Roi des violettes, Princesse Marie, Voltaire, Firth's Virginus, Leighton's Bellerophon, Hodge's Bright Phæbus, Clarke's Magnificent, Hogg's Lord Hill, Wakefield's Paul Pry, Hogg's William the Fourth, Hogg's Penelope, Prince George of Cambridge, Annesley's Lord Hill, Paganini, Douglas's Lady Selkirk, Amour, Prinz von Oranien, Rosalie de Rohan, Louis Philippe, Prince de Condé, and Golden eagle. Red juncating apple, and white juncating apple, from Mr. Joseph Kirke. Specimen of a monstrous grape, from Robert Ferguson, Esq. Striped Hoosaince melons, from T. A. Knight, Esq. Cucumber from Mr. P. Allan. Georginas and marigolds, from Mr. Richard Chandler.

Also, from the Garden of the Society. — Flowers. *Lupinus ornatus*, *Fuchsia virgata*; *Salvia cardinalis*, *Grahami*, and *chamaedryoides*; *Mãdia elegans*; *Pentstemon Richardsoni*, pubescens, atropurpureus, and campanulatus; *Calceolaria bicolor*; *Verbena pulchella*, *Aublétia*, and *chamaedrifolia*; *Callampelis scabra*, *Trachymene cærulea*, *Tournefortia heliotropioides*; American runner, from G. W. Ward, Esq., 1830; georginas, hollyhocks. — Fruit. Apricots: the best blossoms of apricots were starved in the spring; Large early, royal, orange; black, a great bearer, singular, different from that introduced by Sir Joseph Banks, this received from M. Audibert, Tarascon. Plums: Morocco, Wilnot's new early Orleans; Cherry plum, a variety obtained through the French, which bears most abundantly. [A dish of plums, of a kind named "the cherry plum," very interesting in appearance, was, about five years ago, sent for exhibition to a show of the Bury St. Edmunds Horticultural Society. The plums excited much attention at the show, were thought very peculiar, and were brought by a gentleman who attended the show, out of his own garden, if I rightly remember, at Diss. — *J. D.*] Late duke cherry, a few to show its lateness: it would require another week to ripen it perfectly, and it may be kept for the dessert till the end of August; Carnation cherry. Gooseberries: Pitmaston green gage (this sort has the property of hanging long on the bush without turning sour, as is the case with the generality of gooseberries, it shrivels like a raisin, and is good for matting up, to keep late in the season); Red Cham-

pagne, Yellow champagne, Saunders's Cheshire lass, Red Turkey, Rumbullion, Cleworth's white lion, Denny's Shakspeare, Eckersley's jolly printer, Ironmonger, Hebburn yellow Aston, Rival's Emperor Napoleon.

Part iii. vol. i. of the new series of the *Transactions* was announced to be ready for delivery to the Fellows of the Society; and it was announced from the chair that, in consequence of the Society's meeting room being about to undergo repair, the meetings will be suspended, by order of the Council, until the 3d of October.

Conclusion of Mr. Lindley's Lectures on Botany as connected with Horticulture.

LECTURE IV. *Leaves, Flowers, and Fruit.*—The professor commenced by stating, that, as in his previous lectures he had confined himself to those parts of a plant necessary to its stability, he should now proceed to the organs which the stem and root were destined to support. These, though under different modifications, were, in fact, the same, and he should endeavour to prove that leaves, flowers, and fruit were only separate developements of the same organ, applied by nature to various purposes, and under various forms. He would first consider leaves.

He had already explained the manner in which leaves are contained in buds, and the intervals at which they spring; also, that every leaf has in its axil a young bud imperfectly developed. This it was important to remember, as he should afterwards have occasion to show that the presence of this axillary bud was one of the distinct characteristics of leaves. Of the functions of leaves, he had also already spoken; they are employed to elaborate the sap forced up into them from the roots, and to return it in its altered state to the tree. Without leaves, the process of vegetation could not go on. Their intimate connection with the bark might be easily discovered by tearing the petiole of a growing leaf from its point of union with the branch, when it would be found that a portion of the bark, and even of the alburnum, would usually be stripped off with it. Leaves are of various kinds, but nearly all are comprised under two great divisions, the difference between which it is of great importance to be aware of, as they afford distinct marks of the formation of the trees to which they belong. A reticulated leaf, like that of the common rhubarb, always serves to indicate an exogenous plant or tree; and a parallel-ribbed leaf, like that of the *Yucca gloriosa*, an endogenous plant or tree. The professor observed that other differences were indicated by these leaves, to some of which he should presently have occasion to refer. He now directed the attention of his auditors to the different construction of these leaves. The rhubarb leaf has large thick veins, called ribs, spreading out like a fan, or the foot of a fowl, with smaller veins springing from the larger ones, and crossing and recrossing each other angularly, in every possible direction, like network; while the *Yucca* has only a number of strong parallel ribs, with short, slender, transverse lines between them: and this difference in the construction is found to exist almost invariably between the leaves of exogenous and endogenous trees. In some particular points all leaves agree. They are all formed of cellular substance, intersected with air-passages, and are covered, except at the extreme point, both above and below, with a cuticle composed entirely of cellular tissue. The veins are protected by a coating of fibrous tissue, and are filled with spiral vessels. The arrangement and shape of the cellular tissue and air-passages which compose the main substance of the leaf vary in different plants; but the cuticle and the spiral vessels are present in all. Previously to their developement, leaves are enfolded in the bud, and their disposition (while in this state, which is called their prefoliation) differs in different plants. All leaves have numerous pores, for the purpose of absorbing

those portions of the atmospheric air which are necessary for elaborating the sap, and for exhaling the gases of which it requires to be deprived. Parts of a plant are often called leaves, which are, in fact, stems. The professor exhibited a large branch of *Ruscus andrógynus* (a kind of butcher's broom), apparently covered with handsome dark green leaves, on the surface of which were numerous flowers. These, the professor stated, were not really leaves, though nothing could, in shape, texture, and colour, more strongly resemble what we are accustomed to call by that name; but expanded branches, being all deficient in that essential characteristic of true leaves, buds in the axils, and being, of course, incapable of propagation. No portion of the branch of the *Ruscus*, which he held in his hand, could, the professor observed, be made to grow. Whether cut between the nodes, or being a part only of the internodes, the effect would be exactly the same. The real leaves of this plant are brown dry-looking scales, similar to those before described as enclosing buds, and as being the abortive leaves of the preceding year. To demonstrate this more clearly, Mr. Lindley exhibited a stalk of *Ruscus andrógynus* (strongly resembling a large head of asparagus), the branches of which were not expanded, and on which the brown leaves were distinctly visible: in the axils of these leaves buds form in the usual way. Flowers, and real leaves, also form on the surface of the leaf-like branches.

These are not the only instances in which other parts of a plant may be mistaken for leaves. Sometimes the petiole or footstalk of the leaf expands till it becomes scarcely distinguishable from the leaf itself. This is the case with the *Dionæa Muscipula* (or fly-trap), the leaves of which, properly so called, are those parts armed with spines, which collapse, and enclose flies, or other insects, that may happen to touch them. The fleshy parts, below these irritable leaves, are, in fact, only enlarged footstalks. The *Sarracènia* (or side-saddle flower) is remarkable for the singular form of its leaf stalks, which are tubular, and hold water; while the *Nepénthes* (or pitcher plant) has a very singular dilation of the petiole, which forms a tendril, occasionally enlarging into the semblance of a leaf, and ending in a complete pitcher, furnished with a lid, which is the leaf itself.

Flowers are only modifications of leaves; or rather, more correctly speaking, they are, in fact, metamorphosed branches; there being no essential difference, in the eye of a botanist, between flower-buds and leaf-buds, and the expansion of both being in effect the same. Every flower bud proceeds from the axil of a leaf, called a bractea, or floral leaf. On examining a flower perfect in all its parts (the professor exhibited a pæony), it will be found that these bracteas divide the peduncle or footstalk of the flower, from the branch or stem; and that they sometimes form a single whorl, joined together at their margins, and having the appearance of an outer calyx. The flower, with its peduncle springing from these bracteas, is exactly analogous to a branch springing from the axil of a leaf; the peduncle answering to the branch, and the calyx, corolla, stamens, and pistil being metamorphosed leaves. The flower buds being thus in effect the same as leaf buds, are, like them, produced at regular distances, and from alternate sides of the stem. The transformation of leaves into petals is clearly shown in the formation of the common tulip. This flower has no calyx, or, at least, none that can be distinguished from the corolla. It has six leaves round its parts of fructification, which may be either called petals or sepals; or supposed to be three of each, but there is no clear mark of distinction, unless that of the three inner growing from a separate whorl be deemed a sufficient one. The leaves on the stalk of the tulip, or bracteas, are often partially coloured like the corolla, as though they

were incipient petals; and the professor exhibited a tulip in which this monstrosity might be distinctly traced. The pistil, stamens, and anthers, Mr. Lindley said, he had described in a previous lecture, and he should now only advert to them to prove that they are metamorphosed leaves. Immediately within the petals of single flowers is found a whorl of stamens, terminating in anthers laden with pollen. These stamens are nothing but metamorphosed leaves, and in double flowers assume the shape of petals. The pistil is in the centre of the flower, and consists generally of three parts; the style, the stigma, and the seed vessel; the latter being composed of one or more modified leaves, which are called carpella. The midribs of the folded leaves which have become carpella are sometimes elongated into a style, their apexes forming the stigma. Other flowers, the tulip for example, are without this member, and the stigma joins the carpella. In all cases, however, it is the apexes of the leaves which form the stigma, and this portion of the plant (as before observed) is the only one uncovered by a membrane.

The pollen consists of granules of cellular tissue, each containing a mucous substance, composed of a number of molecules or minute bodies always in motion. These are perceptible by means of a powerful microscope, when a granule of pollen has burst, from having been some time immersed in water. The granules of pollen, when fully ripe, fall on the naked stigma, the moisture of which makes them swell, and burst, emitting their mucus, which descends to the seeds contained in the carpella.

Fruit is another stage in the modification of leaves. The lobes of an orange are only carpella, thickened and enlarged, apparently by a provision of nature, to form a source of nourishment for the young plant destined to proceed from the seed. This fleshy substance (including its accompanying parts) is called the pericarpium, or shell of the fruit, which exists in all plants, though in some it is so dry and thin as to be apparently wanting. The formation of the lobes of an orange from the carpella of the pistil, Mr. Lindley illustrated by a preserved specimen of a species of citron, called vulgarly fingers and thumbs, the points of which did not adhere at the apex, but curved out like the stigma of some kinds of plants. He also showed a pine-apple, every flower of which had produced a little pine, and a branch of larch which had thrown out a small plant from its cone. As an example of the occasional thickening of other parts of a flower, besides the carpella, Mr. Lindley showed a curious specimen of a pear, or rather chain of pears, grown in Scotland, proceeding one out of the other.

Seed is always found in perfectly matured fruit, though its position is various. It contains the embryo of the young plant, and is, in point of fact, a detached bud. As soon as germination begins to take place, the integument which envelopes the seed bursts, and the plumula (or stem) and the radicle (or root) protrude themselves in opposite directions. The solid part of the seed which is formed of one or more cotyledons, or thick fleshy leaves, sometimes pushes through the ground (as in the case of the annual lupine, &c.), and forms the base of the stem. In this case, an elongation of the collet or neck, which separates the cotyledons from the radicle, takes place. In other cases, the cotyledons remain under ground, and form a reservoir of nourishment for the young plant till the radicles have acquired sufficient strength to absorb moisture for its support. The cotyledons form another mark of distinction between the two great classes into which nearly all plants are divided. Those with reticulated leaves, and exogenous stems, having two cotyledons, and being called dicotyledons; while those with parallel-ribbed leaves and endogenous stems have only one cotyledon, and are called monocotyledons.

LECTURE V. *Cause of the Circulation of the Sap; Analogy between*

Vegetables and Animals ; Deterioration of Soil in which Plants of the same Kind have grown for a long Period ; Poisons ; Excretions ; Nature of the Sap ; Organs of Respiration ; Cause of Circulation ; Antediluvian Plants. — The professor first observed that every one who had at all considered the subject must be struck with the remarkable analogy which exists between the blood of animals and the sap of plants. Both supply nourishment, and are indeed essentially necessary to the development and support of the vital principle; but both require to be elaborated by circulation before they become fully imbued with their nutritious qualities. Sap, when first absorbed by the roots, is simply water, impregnated with various extraneous substances, derived either from the soil or from accidental circumstances. These substances, some of which are useful and some injurious to vegetation, are absorbed by the plant indiscriminately; the spongioles having no power of selection, but being naturally inclined to take up whatever moisture they can find. The vulgar notion that plants deteriorate if grown too long on the same soil, because they have exhausted all the juices wholesome for them which it contains, is, therefore, manifestly erroneous. That they do deteriorate is true, but the cause is different. The fact that plants will absorb any moisture presented to them has been proved by various experiments; in the course of which they have been forced to take up coloured fluids, and even poisons, which have produced derangement of the ordinary functions, and frequently death. The circumstance that the same poisons act nearly in the same manner on vegetables and animals is another curious proof of analogy between them. All poisons are either corrosive or narcotic; or, in other words, act either by over-stimulating or by relaxing the system; and these different effects have been shown clearly, by various experiments, to be producible on plants. One branch of the common berberry was steeped in a solution of corrosive sublimate, and another in a decoction of opium; when, in a short time, the vessels of the one were found to have become turgid, and of the other relaxed, the natural irritability of the plant being, in both cases, destroyed. The fact that plants absorb aqueous particles indiscriminately, being thus proved, it is clear that they cannot exhaust any soil by abstracting its nutritious qualities, and that the deterioration which takes place in the soil, where the same kind of plant has been grown for any length of time, must arise from some other cause. This cause is the excretions thrown off by the plant, which, in progress of time, literally poison the soil.

The moisture absorbed by the spongioles having ascended to the leaves, and been elaborated there into sap, returns, depositing, by the way, all the nutritious particles it has acquired; and at last throws off the residuum, in the shape of a spongy excrescence, at the root. These excretions, consisting only of what the plant has rejected, are of course unfit for the support of other plants of a similar nature, and may be said to poison the soil. The extraordinary power possessed by plants, of getting rid of injurious substances, has been shown by placing one half of the roots of a plant in a vessel containing pure water, and the other half in a solution of acetate of lead; when, in a few days, the water was found strongly impregnated with the poison. Many other experiments have been tried, but they have always been attended with a similar result. Botanists, observing these facts, have sometimes applied them practically; and, instead of transplanting trees with a ball of earth adhering to their roots, or repotting plants by merely putting fresh earth round the mass of fibrils formed in the former pot, have carefully washed the roots from every particle of their former soil, before placing them in their new situations. Among the remarkable circumstances attending the effects of poisons on plants, it may be observed that a decoction of a poisonous plant will kill a plant of a

similar nature. Thus, a decoction of *A'tropa Belladonna* L. was found to kill a plant of *Belladonna*, &c. The substances thrown off by the root are not the only secretions trees have the power of making. Some trees secrete gum, &c., from the sap in its progress downwards, which they discharge from the bark. Mineral poisons do not operate upon plants, any more than upon animals, in a crude state. Mercury requires to be oxidised, &c.

Notwithstanding the bad effects produced upon plants by injurious substances being mingled with the aqueous particles they imbibe, they will not thrive well in pure water; and the experiments which have appeared to prove that they can exist on water alone have always, on examination, been found to be fallacious. Sap is composed chiefly of water, mucilage, and sugar; but it does not attain its proper qualities till it has been exposed to the action of the atmospheric air in the leaves: it rises through the alburnum, in that part nearest the extremity of the medullary rays; but it is never seen in the heart wood, the vessels once destined for its transmission being found choked up in the centre of the tree when it has attained that state. The sap, having reached the leaves, is there exposed to the action of the atmospheric air, much in the same way as the blood is in the lungs, with, however, this important difference, that, while animal blood principally absorbs oxygen and gives out carbonic acid gas, &c., sap appears to have the greatest affinity for carbonic acid, and to be compelled to give out a portion of its oxygen before it is fit to afford proper nourishment to the plant. The sap first spreads itself along the upper surface of the leaves, immediately under the membrane of the cuticle, and flows back along the lower stratum of veins, in the under side of the leaves. As soon as its elaboration is complete, it descends by the bark, radiating, in its progress, towards the centre of the tree, by means of the silver grain or medullary rays, which consist of masses of cellular tissue, exquisitely though invisibly permeable to fluids. As the sap, during the process of its elaboration in the leaves, has not only to imbibe certain qualities, but to throw off others, plants, like animals, are provided with the necessary organs for a double kind of respiration: these functions, however, are never perfectly performed without the assistance of light. When a plant is exposed to the full action of the sun's rays, it gives out pure oxygen, and absorbs carbonic acid, which is afterwards decomposed in the plant, the carbon only being retained. This operation cannot go on in constant darkness, the plant then only giving out carbonic acid and nitrogen gases, without oxygen, and becoming sickly and languishing. Hence arise the efforts which plants placed in obscure situations are continually making to reach the light. The evaporation of plants is seventeen times greater than that of animals; they consequently require a constant supply of aqueous particles at their roots, to support this copious evaporation, and when deprived of this they perish. In warm dry weather the evaporation is of course greater than in cold and moist weather; and it is always greatest when the leaves are expanded. In winter the evaporation is very trifling; and the reason that transplanting is less injurious in that season than in summer is, that the spongioles, being injured by transplanting, are, in hot dry weather, unable to imbibe sufficient moisture to support the excessive evaporation which takes place through the leaves. As an illustration of this remark, it may be observed that plants in pots, not being liable to have their spongioles injured, will bear removal at any season with perfect ease.

Many hypotheses have been started with regard to the cause of the circulation of the sap. Some have supposed the sap to rise, from its alternate rarefaction and condensation by the changes of temperature; others that the sap-vessels are furnished with valves; others attribute it to

capillary attraction; others to the alternate expansion and contraction of the medullary rays, from hygrometrical changes; others to fermentation; and others to the action of the leaf buds. This last appears the most probable; the expanding leaves, by constantly consuming the sap nearest to them, create a vacuum, which is as constantly supplied by the fresh sap ascending from below; and this theory accounts for the motion of the sap being always most apparent at the extremity of the branches, when they first begin to expand themselves into leaves. The only difficulty is, to know how this action is primarily produced. It has been observed that the fluid contained in the leaf buds is much denser than that in the body of the tree; and Dutrochet, a French physiologist, having discovered, by a series of experiments (Vol. III. p. 78.), that dense fluids possess an attraction for lighter ones, supposed that in this manner he could account for the circulation of the sap. This principle he called the endosmose, or inward impulse; its application, however, to the circulation of the sap, has, it appears, been since abandoned by himself as untenable (Vol. VII. p. 59.); and we are driven back to the supposition that it depends upon vital irritability, and is independent of mechanical causes.

Carbon has been proved to be essential to the existence of plants; and it appears probable that their vigour depends upon the quantity of carbonic acid which they are enabled to absorb. In the earlier ages of the world, carbonic acid is supposed to have existed to such an extent in the atmosphere, as to render it unfit for the respiration of animals. At this period, as we may judge from fossil organic remains, plants acquired extraordinary size and strength; but, from the extreme rarity of floral specimens in the remains alluded to, they do not seem to have produced either flowers or fruits, except in some few instances. It has been already shown that flowers and fruit are only stunted branches, produced by accumulations of sap, or, in fact, by partial disease, or imperfection in the circulation; the abundant supply of carbonic acid, which occasioned the sap to flow freely and copiously, was therefore inimical to their formation. The carbonic acid absorbed by plants during this early period being decomposed, and the oxygen which it contained being again given out into the atmosphere, the portion of oxygen in the air became greater, and the plants being deprived of their too luxuriant food began to produce flowers and fruit; and then appeared cold-blooded animals, which are able to breathe air much more impure than warm-blooded ones. A further purification of the air took place, and finally it was rendered fit for the respiration of man and other warm-blooded animals possessing hearts: plants thus, by the bountiful provision of nature, making the air more fit for man. The fact that preternatural accumulations of sap dispose plants to bear flowers and fruit, is proved by the well-known practice of ringing a sterile tree: this produces an accumulation of sap above the wound; and the free circulation of the sap being thus impeded, it is forced to expand itself in fruit. The extreme heat of last summer caused extraordinary evaporation, and the density of the sap being thus increased, it has flowed this spring with less freedom than usual, and a greater abundance of flowers has been the result. An expedient used to make the jujube tree (*Zizyphus Jujuba* Lamarek) at Malta produce more abundantly, may be accounted for on the same principle. A large piece of limestone is put between the forked branches of the tree, which by its weight bends and contracts the sap-vessels, and prevents the free circulation of the sap. When speaking of the descending sap, Professor Lindley alluded to some experiments tried by Mr. Joseph Thompson of Welbeck (detailed Vol. V. p. 253. 257.). He observed, also, that plants imbibed oxygen during the night, and gave it out again during the day; and he showed a diagram,

illustrating an experiment to prove the different proportions of oxygen given out by plants under different circumstances. When the roots of a plant were immersed in water strongly impregnated with carbonic acid gas, pure oxygen was given out by the leaves; but when the roots were in distilled water, and the leaves were surrounded by oxygen, no oxygen was given out.

The extreme importance of air to leaves having been proved, it is necessary to say a few words on its usefulness to roots; and this is proved by trees always flourishing most when some portion of their roots is near the surface. Even those plants which send down a tap root have always some fibrils to spread out near the surface, so as to enjoy the influence of the air. In pots, plants show the same propensity, the fibrils always extending themselves as closely as possible to the porous sides of the pot.

LECTURE VI. *Functions of the Leaves; Importance of Light and Air to Plants; Colour; Succulent Plants; Wood and Iron Hot-houses; Cuttings; Layers; Grafting; Uprighting; Pruning; Bulbous Plants; Management of Plants in Rooms, in Green-houses and Hot-houses, in Pits; Latitude not always a Criterion for Climate; Bottom Heat; Conclusion.*—The professor began by stating that he had, in a former lecture, left unfinished one of the most interesting and most important subjects in the whole range of vegetable physiology: he alluded to the functions of the leaves. He had before stated that leaves absorb carbonic acid during the day, and oxygen during the night, forming carbonic acid in proportion to the oxygen they have absorbed; that they decompose their carbonic acid during the day, setting free the greater part of the oxygen it contains, and retaining the carbon, which appears to afford them food; and that this process is necessary to their vegetation, though the exact manner in which it acts is at present unknown to botanists. The importance of light and air to plants is well known. When unassisted by these agents, plants lose their colour, and are deprived of many of their properties. Colour is thus evidently produced by the absorption of carbonic acid gas; and the colouring matter may be detected by a powerful microscope, lodged in the cellular substance of the leaf. How this colour is formed, and why it assumes different tints in different plants, are, however, questions which it is at present impossible to decide. The secretions of plants depend upon light, and their flavour and nutritious qualities are materially altered by their exclusion from it. The importance of this knowledge to a practical horticulturist is proved by the fact, that sea-kale, so well known as a wholesome and palatable vegetable, is not eatable in its original state; and that any part of the cultivated plant, if accidentally left exposed to the action of the air and light, becomes tough, and so strong in flavour as to be extremely unpleasant to the taste. Celery, also, in its native state, is poisonous; and it is only the parts that are blanched that are perfectly fitted for the table. Though colour is generally supposed to depend principally on the plant's being exposed to the light, some portion of colouring matter appears to be occasionally absorbed by the root. This colouring substance is, however, never a deep green. Red and yellow, as may be seen in forced rhubarb, &c., are the most common hues. Succulent plants are less susceptible of the influence of light than any others. As they are always natives of hot countries, nature, to prevent the danger they would be exposed to from excessive evaporation, has provided them with leaves almost destitute of pores; and the moisture they absorb by their roots thus remains for the nourishment of the plant. [See p. 234.] It is for this reason that cactuses, mesembryanthemums, and other plants of a similar description, require very little water when kept in pots. Scarcely any carbon is found in plants grown in the dark. Many experiments have been tried to show the stimulus afforded to vegetation by light; trees of the

same species and variety have been planted in the same garden and the same soil, but against walls with different aspects, and differently situated with regard to shade. The effect has been, not only a difference in the growth and appearance of the tree, but also in the size, colour, and flavour of the fruit which it produced. The contrast between plants grown in hot-houses with wooden sash frames, and those grown in hot-houses with iron sash frames, has been found equally striking; the difference of light between the two kinds of houses being as seven to twenty-seven, or, sometimes, as three to twenty-three. Light is required at an early period of vegetation; but, as its properties are to give strength and flavour, it must be admitted with caution, as it is sometimes injurious. Too much light renders the skin of fruits tough, and will make cucumbers bitter. Bérard of Montpellier found that the ripening of fruits is merely the turning the acid which they contain into sugar, by exposure to the light; and that too much light and heat, before they have attained their proper size, will bring on premature ripening, and make them insipid.

The next subject upon which the professor proposed to treat, was the multiplying of plants by cuttings. He had already, he observed, explained the nature of a cutting. It is, in fact, a bud, containing within itself a vital principle capable of developing in opposite directions, from a common point, two cones, viz. the stem and the root. In making cuttings, gardeners take care that each shall contain two or more nodes, or incipient leaf-buds; but they generally take off any expanded leaves that may be on the stem, lest the evaporation from their surface should be too great for the plant to sustain, before fibrils to absorb moisture are formed from its roots; for this reason, also, it is usual to cover cuttings with a glass, and to set them in the shade. Layers are portions of a plant induced to throw out roots without being separated from the parent stem, by burying a leaf-bud in the ground, and affording it an ample supply of warmth and moisture. The branch thus treated is generally split, so as to prevent the return of the sap, and thus to force the bud to throw out radicles. Grafting may be called planting a bud in a tree, instead of in the ground; and inarching bears the same resemblance to grafting, as layers do to cuttings. Neither grafting nor inarching can be performed with any prospect of success, unless the trees to be united have an affinity to each other; and, even when they have, some plants unite more readily than others. It is very difficult to make a pear grow on an apple, but it will graft freely on a hawthorn or a quince. Care must be taken, however, in all cases, that the parts are properly joined, so that the edges of the corresponding tissue may come in contact, or no union will take place.

Pruning is a branch of horticulture that requires great skill. Different parts of a tree produce fruit; and it is necessary to know these, to be able to prune with advantage, as an ignorant pruner might make the most fertile trees sterile, by cutting off the only parts likely to produce fruit. In some trees, fruit grows only on the extremity of the branches, and on others on the spurs. The use of pruning fruit trees is to prevent their running too much to wood. Fruit and forest trees, of course, require quite different management in this respect; as the object, in one case, is to make wood, and, in the other, to check it. Too much pruning is, however, bad for both. The professor here observed that he had intended to give some directions respecting the best methods of saving seed, but he found that time would not permit.

The scales of bulbous plants contain not only undeveloped leaves, but nourishment for the stem. It is extremely difficult to propagate bulbs in this country; and hyacinths, &c., imported, rarely retain their beauty after the first season. This the professor attributed to the injury sustained by their leaves, either from frosts or want of care. In Holland, the leaves

are carefully guarded from any kind of injury. Mr. Lindley urged growers of bulbs to try to multiply them in England; and, to encourage them, mentioned the fact, that Mr. Knight had contrived to make the Guernsey lily flower luxuriantly with him for several successive years, though that plant generally deteriorated in this country as much as the hyacinth. Cape bulbs are particularly difficult to manage in this country, from the difficulty of keeping their leaves in health. Succulent plants will not bear moisture, from their want of evaporating pores.

It is very difficult to make plants grow in rooms. They must necessarily be deficient in the three important auxiliaries to vegetable life, light, air, and moisture; the latter of which cannot be maintained in apartments that are daily occupied. In large towns, plants cannot thrive even in the open air, as the minute particles of soot, which are constantly floating about, settle upon their leaves, and choke up their pores. The gases produced by the combustion of coal, &c., are also injurious to plants. Sulphurous acid, which abounds in the atmosphere of London, turns the leaves yellow; and the want of evaporation and absorption by the leaves prevents the proper elaboration of the sap, and makes the trees stunted and unproductive.

Green-houses and hot-houses require great care in their management; but it is not easy to lay down rules for that purpose. The principal object is, of course, to imitate the native climates of the plants kept in them; and to do this effectually, by artificial means, requires not only science, but practice. The first point to be ascertained is, the kind of climate natural to the plant; and, to do this, it is not merely necessary to know the longitude and latitude of the place where it grew. Many circumstances combine to produce a variation in climate. Islands are generally warmer than continents; and the vicinity of mountains, or rivers, or being in an exposed or sheltered situation, will often occasion most remarkable differences. Climate always varies according to the elevation of any given spot above the level of the sea; 200 yards of vertical elevation being considered equivalent to a degree of latitude. Isothermal lines drawn across one of Mercator's charts, according to the degrees of latitude, and marked with the plants flourishing in different countries, would show strongly this fact. Whatever warmth may be given, or care bestowed, no plants will grow well without change of air and abundance of light. For this reason, peaches seldom, if ever, thrive below vines; as, even if they are so contrived as to be placed at the back of the house, while the grapes hang in front, the stone pavement of the path prevents the air from getting to their roots.

Pits are small hot-houses; and there appears no sufficient reason why they should not be managed exactly in the same manner. The professor observed, however, that gardeners generally appear to think otherwise; as they are in the habit of giving their pits a lining of dung, &c., to produce what they call bottom heat, which they never think of applying to hot-houses. This practice the professor strongly reprobated. He maintained that there is no such thing as bottom heat in nature; and that it is contrary to all established theories, to produce excessive heat and fermentation round the roots of cucumbers, and such plants as are generally grown in hot-beds. As a proof that this practice is not a good imitation of nature, he mentioned that the best melons in Persia are grown on ridges of earth having water in the channels between them.

In conclusion, the professor apologised for having only imperfectly developed his subject. He had found it impossible, he said, to compress into six lectures what might have afforded ample material for fifty; and he threw himself upon the consideration of his auditors, to excuse any omissions or errors which he might have made.

ART. VI. Covent Garden Market.

		From		To				From		To			
		£	s.	d.	£	s.	d.	£	s.	d.	£	s.	d.
<i>The Cabbage Tribe.</i>													
Cabbages, per dozen:		0	0	8	0	1	0	0	0	5	0	0	0
White	-	0	1	6	0	2	6	0	0	0	0	0	6
Red	-	0	2	6	0	3	0	0	0	9	0	1	6
Plants, or Coleworts	-	0	3	0	0	6	0	0	1	0	0	1	6
Cauliflowers, per dozen	-	0	0	8	0	1	0	0	0	0	0	2	6
Broccoli, Cape, per bunch	-												
<i>Legumes.</i>													
Peas, per sieve	-	0	3	0	0	3	6	0	1	0	0	1	6
Windsor Beans, per $\frac{1}{2}$ sieve	-	0	1	0	0	0	0	0	3	0	0	0	0
Kidneybeans, per $\frac{1}{2}$ sieve	-	0	1	0	0	0	0						
<i>Tubers and Roots.</i>													
Potatoes	-	2	0	0	3	0	0	0	1	0	0	1	6
	{ per ton	0	2	3	0	3	0						
	{ per cwt.	0	1	3	0	1	9						
	{ per bush.												
Jerusalem Artichokes, per half sieve	-	0	1	0	0	1	6						
Turnips, White, per bunch	-	0	0	3	0	0	5						
Carrots, per bunch	-	0	0	4	0	0	6						
Horn, per bunch	-	0	0	6	0	0	0						
Red Beet, per dozen	-	0	0	9	0	1	6						
Horseradish, per bundle	-	0	1	6	0	4	0						
Radishes:													
Red	{ per dozen hands (24 to 30 each)	0	0	9	0	1	0						
White Turnip, per bunch	-	0	0	1	0	0	1 $\frac{1}{2}$						
<i>The Spinach Tribe.</i>													
Spinach	{ per sieve	0	1	6	0	2	0						
	{ per half sieve	0	1	0	0	1	3						
New Zealand, per $\frac{1}{2}$ sieve	-	0	2	0	0	0	0						
Sorrel, per half sieve	-	0	1	0	0	0	0						
<i>The Onion Tribe.</i>													
Onions, per bushel	-	0	2	6	0	3	6						
For pickling, per $\frac{1}{2}$ sieve	-	0	1	6	0	2	6						
Leeks, per dozen bunches	-	0	0	0	0	1	6						
Garlic, per pound	-	0	0	6	0	0	8						
<i>Asparaginous Plants, Salads, &c.</i>													
Artichokes, per dozen	-	0	2	0	0	4	0						
Lettuce, per score:													
Cos	-	0	0	9	0	1	6						
Cabbage	-	0	0	6	0	1	0						
Celery, per bundle (12 to 15)	-	0	1	6	0	2	0						
Small Salads, per punnet	-	0	0	2	0	0	3						
Burnet, per bunch	-	0	0	1	0	0	1 $\frac{1}{2}$						
<i>Pot and Sweet Herbs.</i>													
Parsley, per half sieve	-	0	1	0	0	1	6						
Tarragon, per dozen bunches	-	0	5	0	0	0	0						
Fennel, per dozen bunches	-	0	2	0	0	0	0						
Thyme, per dozen bunches	-	0	2	0	0	0	0						
Sage, per dozen bunches	-	0	2	0	0	0	0						
Mint, per dozen bunches	-	0	1	6	0	2	0						
Peppermint, per doz. bun.	-	0	1	0	0	0	0						
Marjoram, per dozen bunch	-	0	1	6	0	2	0						
Savory, per dozen bunches	-	0	1	6	0	2	0						
Basil, per dozen bunches	-	0	2	0	0	0	0						
Rosemary, per doz. bunches	-	0	4	0	0	0	0						
Lavender, per dozen bunch.	-	0	3	0	0	4	0						
Tansy, per dozen bunches	-	0	1	0	0	0	0						
<i>Stalks and Fruits for Tarts, Pickling, &c.</i>													
Angelica Stalks, per pound	-	0	0	5	0	0	0						
Sea Samphire, per punnet	-	0	0	0	0	0	6						
Vegetable Marrow, per doz.	-	0	0	9	0	1	6						
Gourds, per dozen	-	0	1	0	0	1	6						
Tomatoes, per half sieve	-	0	0	0	0	2	6						
Capsicums, per hundred:													
Green	-	0	1	0	0	1	6						
Ripe	-	0	3	0	0	0	0						
<i>Edible Fungi and Fuci.</i>													
Mushrooms, per pottle	-	0	1	0	0	1	6						
Morels, per pound	-	0	12	0	0	0	0						
Truffles, per pound:													
English, fresh	-	0	3	0	0	0	0						
Foreign, dried	-	0	12	0	0	0	0						
<i>Fruits.</i>													
Apples, Dessert, per $\frac{1}{2}$ sieve:													
Kerry Pippin	-	0	2	0	0	0	0						
Downton	-	0	3	0	0	0	0						
Hawthornden	-	0	1	0	0	1	6						
Nonsuch	-	0	1	6	0	2	0						
Baking, per bushel	-	0	2	0	0	4	0						
Pears, Dessert, per $\frac{1}{2}$ sieve:													
Jargonelle	-	0	3	0	0	4	0						
Summer Bon Chrétien	-	0	2	0	0	3	0						
Lammas	-	0	1	0	0	1	6						
Bergamot	-	0	2	0	0	3	0						
Peaches, per dozen	-	0	0	6	0	2	0						
Nectarines, per dozen	-	0	0	6	0	1	6						
Apricots, per dozen	-	0	1	0	0	1	6						
Plums, Dessert { per $\frac{1}{2}$ sieve													
	{ per punnet	0	1	0	0	0	0						
Green Gages	-	0	5	0	0	7	0						
Baking, per half sieve	-	0	2	0	0	3	0						
Cherries, per pound	-	0	0	6	0	1	6						
Mulberries, per gal. (2 pots.)	-	0	0	4	0	0	8						
Berberries, per half sieve	-	0	2	6	0	3	6						
Elderberries, picked, per bushel	-	0	7	0	0	0	0						
Currants, Red, for tarts, per half sieve	-	0	3	6	0	0	0						
Raspberries, Red, per gallon (2 pottles)	-	0	0	6	0	0	0						
Walnuts, per bushel	-	0	7	0	0	10	0						
Filberts, English, per 100lbs.	-	1	10	0	2	0	0						
Hazel Nuts, per peck	-	0	1	0	0	1	6						
Pine-apples, per pound	-	0	2	6	0	5	0						
Grapes, per pound:													
Hot-house	-	0	1	0	0	2	0						
From the open wall	-	0	0	6	0	0	9						
Figs, per dozen	-	0	0	9	0	1	6						
Melons, each	-	0	0	6	0	2	0						
Cucumbers:													
Frame, per brace	-	0	0	6	0	0	0						
Pickling, { per hundred													
	{ per thousand	0	7	0	0	10	0						
Large, per dozen	-	0	0	2	0	0	3						
Lemons { per dozen													
	{ per hundred	0	6	0	0	16	0						
Sweet Almonds, per pound	-	0	2	6	0	3	0						
Nuts, per peck:													
Spanish	-	0	3	0	0	4	0						
Barcelona	-	0	6	0	0	0	0						

Observations.—Our market has been, with few exceptions, abundantly and regularly supplied with every description of produce usual at this season. The prices of many of them, hitherto considered leading articles at this period, have been ruinously low, to the great injury of the horticultural interest, and all others immediately connected with it, which will, conjoined with the general state of depression existing in the trade, and arising from various causes, be productive of serious consequences, if not immediately relieved by a favourable change in the demand for vegetable productions. During the last few years, these have not been disposed of at a labour price; consequently the growers have now come pretty generally

to a determination not to attempt that high, but necessarily expensive, state of culture hitherto pursued by them. The discharge of half their usual labourers will probably be the first step, as being one of immediate effect; throwing up a portion of their land will be the next; and turning a portion of their uncovered land to agricultural purposes, for their own immediate consumption will be the next. The consequences of such proceedings may be readily anticipated by any one conversant with the many very important interests that will be sensibly affected. I do not hesitate to offer it as matter of opinion, that this state of things has been much encouraged by the false stimulus of extensive capital and enterprise, which has been for the last twenty or thirty years applied to horticulture as well as agriculture, the reaction on which has only anticipated a few years. I am well aware that to establish such opinion would require an extended inquiry into many of the causes, which my limits in this article will not allow.

The drought of July and part of August has created a deficiency in the usual crops of turnips, coleworts, &c.; but the late refreshing rains, and the present fine warm weather, will soon furnish us with a full supply of them. Peas, beans, and French beans have been in great abundance and of excellent quality. The prices, as may be observed on the list, moderate, and, in many instances, very low. Carrots are becoming plentiful, and of better quality than was at first expected. Onions for pickling have been most abundant, at about one third of last year's prices, which induced many persons in Bedfordshire to cultivate them, who had not before attempted it. We have had frequently eight or ten cart loads on a market day, brought from Biggleswade, Sandy, and Girtford, a distance of forty or fifty miles. I am informed that great quantities have been sent from Bedfordshire to Birmingham, Coventry, and even to Leeds, a distance of 70, 100, or 150 miles. Cucumbers are also extensively cultivated at that distance; but, in consequence of the prevailing alarm, the prices have been so low that they would not realise the expense of carriage. The same observation will apply to those grown in the immediate neighbourhood of London, where a large capital is employed in their culture, being very generally grown under hand-glasses, and at considerable expense; but acres have been destroyed, and the remainder sold for little more than the cost of labour in gathering and bringing them to market.

The prospect of a good fruit season, in the early part of the summer, gave promise of a good autumn; but the alarm has also extended to this, and produced a most direful change for the growers. The crop is certainly good, especially of pears and apples; but plums and damsons are not so plentiful. Filberts and walnuts are in excellent supply. Wall fruit generally has been supplied in profusion, and perhaps never at so low a price; but nevertheless it cannot be disposed of. Grapes, which are at all times considered wholesome, have this year suffered under the prevailing interdict, and, although of excellent quality, are offered at prices which in ordinary seasons would be obtained for those of a very indifferent kind, but cannot be disposed of. Pine-apples of good size and condition have been sold at 2s. 6d. per lb., a price never before heard of, except for those of indifferent quality and small size. The supply has certainly been large, owing to the increased culture of them, and the comparative facility with which they are now produced; but the returns to the growers will necessarily oblige them to abandon the pursuit, as they cannot in this country possibly grow them at any rate under 5s. per lb., and of course occasionally at four times that price. The supply of Dutch melons has been less than usual, in consequence of there being no sale for them here: our own produce has been plentiful, but unsaleable at any price. Altogether this may be considered

a more distressing season for the growers, than any they have felt among the several preceding, and these have been far from favourable. — *G. C. Covent Garden, September 17. 1832.*

ART. VII. *Provincial Horticultural Societies.*

PRESS of matter has obliged us to abridge the accounts sent us to an extreme degree, and to omit nearly all the names of the competitors at the different shows, and of the florists' flowers. With regard to the latter, however, we may just observe, that, of the auriculas, Grimes's Privateer seems to have made the most successful cruise, and to have taken most prizes. Cottagers' prizes have been given every where, and we may mention the practice lately adopted in Norfolk, of giving silver spoons, &c., instead of medals, as one which appears to us worthy of imitation. — *J. W. L. for Cond.*

ENGLAND.

CAMBRIDGESHIRE.

The Cambridgeshire Horticultural Society. — *May 16.* A number of prizes were distributed; but the only exotic plant exhibited, the name of which is mentioned, was *Dodecætheon Meadia* var. *gigantæa*. Cottagers' prizes were given for heartsease, stocks, and lettuces. (*Cambridge Chron., May 18.*)

CUMBERLAND.

Carlisle Floral and Horticultural Society. — *May 31.* Mr. Rothwell of Mains exhibited a very fine collection of plants, &c.; amongst which were the *Agapânthus umbellatus* in full flower, the *Cereus phyllanthoides*, the *Maurândya semperflorens*, and the *Maurândya Barclayana*; several specimens of native water plants, two of which were much admired, the *Nymphæa alba* and the *Nuphar lutea*; he had also a small orange tree bearing fruit. Mr. Rothwell had two heads of Danish broccoli, of great size; one of them weighing $12\frac{3}{4}$ lb., and the other $8\frac{1}{2}$ lb. The richest collection was probably from Crofton Hall; but as the gardener, Mr. Pape, was appointed one of the judges, he did not contend for any of the prizes. In this collection we observed a most beautiful specimen of the *Passiflora alata*, an *Azalea indica alba*, a very fine capsicum, a *Vinca rosea*, a *Spigelia marilandica*, &c.; besides a very fine pine-apple (the only one shown), for which the committee awarded a prize of 1*l.*; and some of the largest rhubarb we ever saw. Mr. Slater of this city had some beautiful specimens of plants, &c., which were much admired; amongst these were the *Cereus speciosissimus*, the *Erica ventricosa superba*, besides a great variety of geraniums. Mr. R. Ferguson of Harker Lodge had a fine specimen of the *Musa coccinea*, the *Gloxinia cauliflora*, and also produced the best grapes. There was a large collection of tulips; the best from Mr. Hodgson of Houghton House, who had also the best bouquet of flowers. Mr. R. Mounsey had a very beautiful *Polýgala oppositifolia*; and also obtained prizes for the best dish of apples, the best rhubarb, the best asparagus, and the best salad. Mr. W. Graham of this city had a good show of plants, amongst which were the *E'pæris grandiflora*, a species of *Aphelæxis*, and the *Calceolaria rugosa*; besides several beautiful geraniums. Messrs. Hutton of this city had some fine specimens of the *Rhododendron ponticum* in flower, the *Polýgala oppositifolia*, and the *A'juga alpina* (a rare native plant); besides several others of much beauty. It is impossible to enumerate all that were deserving of notice. Besides what we have named, there were numerous elegant bouquets of flowers, and various plants, from the gardens of the Misses Losh of Woodside, Mr. P. Dixon of Warwick, Mr. J. Dixon of Knells, Captain Halton, Mr. Slater, &c. &c.

Among the plants for which prizes were awarded, we have only room to notice *Cereus speciosissimus*, *Polýgala oppositifolia*, *Musa coccinea*, *Gloxinia caulescens*, and *Ajuga alpina*. Mr. James of Barrock Lodge received a prize for the best peas grown in open ground; gardener, John Lancaster. These were the only peas shown: they were of fine quality and good size; and, we understand, this is the first instance, in Cumberland, of peas grown in open ground being ready for the table in May. (*Carlisle Journal*, June 2.)

Whitehaven Horticultural Society. — May 1. The show was most splendid, and the description of it occupies two columns in the *Whitehaven Herald*. *Epiphyllum speciosum* and *Acacia armata* were the most conspicuous objects; and one bouquet contained *Amaryllis formosissima*, *Fuchsia coccinea*, *Fuchsia gracilis*, *Cereus speciosissimus*, *Calceolaria integrifolia*, and an infinite variety of other choice flowers. The auriculas and polyanthus were very good. Among the former we noticed splendid specimens of Booth's Freedom, Kenyon's Ringleader, and Redman's Metropolitan; and we feel hopeful that in a short time our auricula shows will be worthy of countenance from the great Lancashire growers. Mr. Gaitskell deserves praise for a specimen of that scarce native, the *Gentiana verna*. Prizes were given for hardy plants, including *Uvularia perfoliata*; for rare native plants, cucumbers, asparagus, rhubarb, apples, pears, early spawned potatoes, and true or grown early potatoes. By spawned potatoes is to be understood young tubers produced in the dark from old ones, without the aid of leaves; and which are, of course, nothing more than a part of the matter of the old potato in a new form. This practice is complete vegetable profligacy, and, therefore, ought not to be encouraged; though gardeners are sometimes obliged to resort to it, to gratify the sickly appetites of their employers. (*Whitehaven and Cumberland Herald*, May 8.)

May 26. Another splendid show, abounding in bouquets, chiefly sent by ladies, who, as our Cumberland reporter observes, understand this department better than gardeners. A head of sulphur broccoli is stated to have been positively the finest thing of the kind ever beheld; in size, solidity, and perfectness it was truly matchless. An equally perfect cucumber, from Irton Hall, was exhibited. A number of fine native plants, and long lists of tulips, pelargoniums, green-house plants, herbaceous plants, heaths, &c., with salads, cucumbers, cauliflowers, &c., obtained prizes. (*Ibid.*, May 29.)

DEVONSHIRE.

Devon and Exeter Florists' Society. — April 25. A great many florists' flowers obtained prizes; and among the green-house plants were *Chorozema Henchmannii*, *Cymbidium aloifolium*, *Azalea indica phoenicea*, *Calceolaria Gilleniana*, new *Sparaxis grandiflora*, *Erica Persoluta alba*, and *Orchis Satyrion* [*Satyrium hircinum*?]. A great number of very beautiful plants were exhibited, especially from the nurseries and conservatories of Messrs. Lucombe, Pince, and Co., Mr. Veitch, Messrs. Dymond and Co., Mr. Charles Selater, and many others. Among the plants exhibited by amateurs was a magnificent specimen of the *Pæonia Moulan*, from the conservatory of Mrs. Johns, Hill's Court, bearing on it more than a hundred buds and flowers. (*Trelawny's Exeter Flying Post*, May 3.)

Devon and Exeter Botanical and Horticultural Society. — May 4. Among numerous plants exhibited were, a gorgeous specimen of *Azalea indica*, with 2000 fully blown flowers; and the Queen of the Fairies rose, "tiny in appearance, but of the most delicious fragrance, and rare in that part of the country." (*Ibid.*, May 3.)

Devon and Cornwall Horticultural Society. — Among the American plants, *Lêdum latifolium* and *Ammýrsine buxifolia* were much admired. The species of pelargoniums and ericas were numerous and excellent.

Among other plants particularly demanding notice were, a fine *E'pactis pulchella*, *E'pactis grandiflora*, a *Chorózeina Henchmännü*, *Sprengèlia incarnata*, *Polygala latifolia*, a variety of *helicbrysums*, a fine *Bánsia serulata*, a large and splendid assortment of New Holland plants; and last, though not least, a display of *ranunculuses* which exceeded any thing we have ever seen of a similar kind. Among other rarities, we remarked a specimen of *Cycas revoluta*, or sago palm. Prizes were given for fruits, flowers, and plants, both from gentlemen's gardens and the gardens of cottagers, to a great extent. Some grapes were brought in, the preceding night, a distance of seventeen miles, swung on a handbarrow between the shoulders of two gardeners, to preserve the bloom on them. In the course of an introductory speech, replete with judicious remarks, the secretary referred to some of the new regulations introduced by the gentlemen of the committee; and, among the rest, to the new form of tickets which competitors for prizes were required to adopt, and which, if filled up in compliance with the directions of the committee, would have the effect not only of promoting the interests of the exhibition, but also extending the utility of the Society, by enabling the secretary to furnish such a report of the proceedings of each exhibition as has been recommended in the *Gardener's Magazine*, and as would be truly useful to the public. The following is the size and form of the ticket, which every exhibitor must fill up: —

ROYAL DEVON AND CORNWALL
HORTICULTURAL SOCIETY.

EXHIBITED FOR A PRIZE.

Name of }
Article. }

Season.

Size or }
Weight. }

Colour.

Quality.

Quantity.

Culture.

Private }
Mark. }

GLOUCESTERSHIRE.

Gloucester Horticultural Society. — April 27. Several exotics and rare plants were exhibited; and there was a strong competition among the exhibitors of culinary articles and fruits. Among the latter were two superb pine-apples, and some early strawberries. (*Bristol Mirror*, May 5.)

May 25. The exhibition of tulips was one of the best that has occurred since the formation of the Society. There were splendid contributions from the hot-houses and green-houses, and beautiful pines, grapes, and strawberries, with a fine plate of raspberries. The asparagus was good, but the peas and potatoes were of inferior quality. Every class of productions of the season received prizes, and the raspberries an extra-prize. No cottagers' prizes. (*Gloucester Journal*, May 26.)

Cirencester Horticultural Association. — May 18. Grapes, sent by Mr. Pillans, gardener to Lord Ducie, are particularly commended. The vines were grown in pots, and were only a year old: the method of culture is said to be known only to Mr. Pillans; and if this be the case, we should be much gratified in making it known to the public through the Gardener's Magazine. (*Ibid.*, May 26.)

HEREFORDSHIRE.

Hereford Horticultural Show. — April 24. Numerous prizes were awarded for all the different articles of the season. The finest green-house plant was *Hovea Celsü*; and the next, *Erica propendens*. (*Hereford Journal*, May 2.) It is stated in this paper that a head of broccoli, weighing upwards of 12 lbs., was cut, in the last week of April, in the garden of Mr. Marshall of Stow Hill, Newport. The plant covered nearly 30 square feet of surface.

May 8. The tulips were beyond all praise, and the pelargoniums never more splendidly in bloom. There was a remarkably fine show of flowers, fruits, and vegetables. The small stand presented a beautiful collection of auriculas, polyanthuses, hyacinths, heaths, pansies, green-house and stove plants, which were deservedly admired. The grand stand also contained a fine display of plants and flowers, excellently arranged; and the stage for fruits and vegetables was never better filled. There were strawberries and apples, cucumbers, asparagus, kidneybeans, potatoes, mushrooms, sea-kale, rhubarb, cabbage, broccoli, lettuces, endive, &c., all remarkably fine, and in great abundance. (*Ibid.*, May 9.)

Ross Horticultural Society. — April 25. We regret to find that this institution, the first of the kind established in England, is beginning to fall off, and that a great arrear of subscription was due for the last year. We hope, with the editor of the *Hereford Journal*, that the spirit of Kyrle (the celebrated Man of Ross) will yet be found in its present numerous and highly respectable members. The hyacinths were excellent, and the broccoli and other vegetables fine. The number of specimens ticketed and entered on the books of the Society amounted to 250; and the evening's sale of fruits and vegetables produced 2*l.* 1*s.* 5*d.* (*Ibid.*, May 2.)

May 23. This was an excellent show, and well supported by a numerous attendance of subscribers and lovers of horticulture. The grand stand presented one of the most rich and beautiful displays of stove, green-house, American, and hardy plants; and we have never witnessed a better assortment, in quality, bloom, and growth, nor in its arrangement and striking effect. The prize stand, from these specimens, excited universal admiration. The long stand in the centre of the room was well covered with tulips and anemones; and every florist admitted that the tulip blooms were never finer in size and colour. We regret, however, to state a falling off in the number of specimens, there being only 576, about 250 less than at this show last year. The evening sale produced only 2*s.* 6*d.* (*Ibid.*, May 30.)

LANCASHIRE.

Lancaster Floral and Horticultural Society. — April 26. The auriculas and polyanthuses, as well as vegetables and fruits, were fine and in good order. Among the hardy plants were, that elegant shrub *Ribes sanguineum* in most excellent flower, *Gentiana verna*, and a large bunch of wild tulips grown in our immediate neighbourhood. As usual, a number of prizes were given. (*Lancaster Herald*, May 28.)

May 18. The exhibition of flowers was better than had been anticipated from the weather. The tulips were in good colour, and very numerous. There were several excellent pelargoniums, green-house plants, Cape heaths, hardy plants, and rare natives; white and black grapes, strawberries, pears, apples, and gooseberries. This Society, we hear, intends to form a fund, to be called "The Cottager's Fund;" the object of which is to enable the Society to grant prizes to the labouring poor not receiving parochial relief, and who cultivate their gardens without hired labour. We need scarcely express an approval of this measure, because but one opinion on the subject can be entertained. (*Ibid.*, May 19.)

June 18. The pinks, though few in number, were very fine; and the ranunculuses both numerous and good. There was but a poor collection of green-house plants, owing, probably, to the extreme wetness of the morning, and the distance from the town at which several subscribers and contributors live, the risk of injury to plants being thus considerably increased. The grapes and strawberries were very fine; but the most extraordinary production was a bunch of rhubarb, consisting of eight stalks, which weighed 13 lbs. The circumference of one of these stalks was 9 in. (*Ibid.*, June 23.)

NORFOLK.

Diss Horticultural Society. — April 12. Numerous prizes were given for green-house plants, polyanthuses, dessert apples and pears, and forced culinary productions. A yellow seedling polyanthus was considered by the judges to be a most beautiful specimen. It was raised by Mr. Hort of Wortham, named Hort's Lady Maria Keppel, and purchased at a very high price by Messrs. Bircham and Rednall, florists, Holton, near Halesworth. Numerous cottagers' prizes were given, which we are always, and in all places, happy to see. (*East Anglian*, April 24.)

June 21. Owing to the backwardness of the season, the exhibition of fruit was small; there being only six dishes of strawberries, and one small plate of cherries, the last, and two of the former, the productions of cottagers; and a fine melon, sent by Mr. Flower of Eccles. Of the vegetables, those from the garden of Mrs. Harrison of St. John's bore the palm. A brace of cucumbers, a new sort raised by Mr. Girling of Stowmarket, were remarkable for size and quality. A bunch of seventeen stalks of rhubarb was exhibited by Mr. C. H. Browne, which weighed 9 lbs. 2 oz., and several of them measured 17 in. and 28 in. in length. The show of flowers was very good. Mr. Taylor's pelargoniums were splendid; the Rev. G. R. Leathes sent a very fine specimen of *Lophospermum erubescens*, two varieties of cactus, and other rare plants; Sir E. Kerrison, a beautiful cactus and some choice pelargoniums; and the bouquet exhibited by the Misses Brown of Diss was universally admired, for the beauty of the flowers and the exquisite taste of its arrangement. The ranunculuses were few, but excellent. The cottagers' table was completely covered with excellent productions. (*Norwich Mercury*, June 23.)

Norfolk and Norwich Horticultural Society. — April 18. Numerous prizes were given for fruits and vegetables; for Elfrod rhubarb blanched in decayed sawdust; and for very large leeks grown in trenches like celery, as in France, where the leek is considered an indispensable ingredient in certain soups. The show of flowering plants was particularly brilliant.

Mrs. Mackay, without competing for the prizes, sent above fifty choice green-house plants, among which the following were most striking and beautiful specimens:—*Amarýllis psittacina*, *Kennèdya Comptoniana*, *Hibbèrtia dentata*, *Ròsa fràgrans*, *Brachysèma latifòlium*, *Lechenaúltia formòsa*; *Èrica mùndula*, *procèra*, *vèrnix coccínea*, *nigrita*, *Wàlkeri*, and *Linnæ'a*; *E'pacris grandiflòra*, *pàludòsa*, and *purpuràscens*; *Lysinèma púngens* and *attenuàta*, Knight's Starry Lily, *O'xalis floribúnda*, *Berberis glumàcea*, *Gesnèria bulbòsa*, and a splendid assortment of hyacinths; among which the most rare and beautiful were *l'Importante*, *Voltaire*, *Grande Vidette*, *la Majesteuse*, *l'Abbé de Vérac*, *Chrysolora*, *Duke of Wellington*, *Vainqueur*, *Marquise de la Coste*, *Passe non plus ultra*, *Groot vorst*, &c.; also a branch of that beautiful plant the *Ribes sanguíneum*, of which there is a most magnificent specimen now in full flower in the open borders at the nursery. The camellias, especially *Camèllia japònica Chàndleri*, were very fine. Eight silver teaspoons were distributed as prizes, in lieu of the smaller medals. This practice has long been general in Scotland; and well deserves imitation, on account of its utility. (*Ibid.*, April 28.)

June 13. The heaths, the geraniums, ranunculuses, and, in short, a catalogue which it is impossible for us to enumerate, displayed the skill and earnestness with which the science is now prosecuted. Mr. Toll was again particularly distinguished. The only grapes were sent by Lord Stafford, and the only pines by Mr. Crawshay. These, two remarkably fine queen pines, were grown in Glamorganshire, in a situation 640 ft. above the level of the sea. There were some remarkably fine strawberries and other fruits. The esculents were of great size and excellence. A specimen of the giant rhubarb was shown upon a leaf of enormous circumference. The cottagers' prizes included florists' flowers, as well as preserved vegetables and early lettuces, cucumbers, peas, and potatoes; also green gooseberries and tart rhubarb. Mrs. Mackay contributed (as usual, not for prizes) *Calceolària Yoúngii*, *pernotàta* (splendid specimens), *hýbrida*, *thyrsiflòra*, *lanceolàta*; *Èrica vestita coccínea*, *ventricòsa carnea*, *perspícua*, *tubiflòra*, *odòra*, *ròsea*, *squamòsa*, *exímia*, *spléndens*, &c.; *Amarýllis Johnsonii*, *formosíssima*; a collection of choice double anemones, and specimens of many fine herbaceous plants. (*Ibid.*, June 16.)

Mr. George Thurtell's *Ranunculus Show* was held on June 13., when he exhibited between 700 and 800 blooms, including 360 varieties; preeminent in beauty, variety, colour, form, and size. (*Ibid.*, June 16.)

NORTHAMPTONSHIRE.

Northamptonshire United Horticultural Society.—April 24. A number of florists' flowers were exhibited, and a still greater number of rare hardy green-house and hot-house plants. The greater proportion of these, amounting to between thirty and forty sorts, were sent by Mr. Atkins, who has lately raised a beautiful hybrid calceolaria, which bears his name. *Ribes sanguíneum*, exhibited by Mr. Atkins, excited universal admiration. (*Northampton Mercury*, April 28.)

NORTHUMBERLAND AND DURHAM.

Northumberland and Durham Botanical and Horticultural Society.—April 6. A fine show of green-house plants, flowers, and vegetables, among which were some excellent early potatoes, and a dish of remarkably fine kidneybeans. *E'pacris grandiflòra* is the only plant named which gained a prize. (*Newcastle Courant*, April 12.)

May 10. Among the various exotics exhibited, we noticed the following, viz.: *Clerodéndrum fràgrans*, *Gladíolus ròseus*, *Mùsa coccínea*, *Gloxínia speciósa*, and *Cèreus phyllanthòides*, from the garden of W. Losh, Esq., Little Benton; *Hóya carnòsa*, and *Hibiscus Ròsa sinénsis*, from the

garden of R. Blackbird, Esq., Villa Real; *Corræ'a speciosa*, *Erythrina Crista-galli*, *Thunbergia alata*, *Pultenæ'a stricta*, *Erica cylindrica*, and *Grevillea rosmarinifolia*, from the garden of J. G. Clarke, Esq., Fenham. A beautiful queen pine was exhibited, from the garden of A. Donkin, Esq., Jesmond, and several beautiful geraniums. An uncommonly fine specimen of *Rosa Banksiæ* was exhibited from the garden of J. Walker, Esq., Benwell. (*Ibid.*, May 19.)

June 1. Numerous prizes were awarded for superior specimens in every department. Among the various exotics were *Polygala oppositifolia*, *Pimelæa decussata*, *Cereus speciosissimus*, *Erythrina Crista-galli*, *Vinca rosea alba*, *Thunbergia alata*, *Eutaxia myrtifolia*, *Agapanthus umbellatus*, and Falla's seedling *Gloxinia*; also six stalks of rhubarb, weighing 17½ lbs. (one of which measured 7½ in. in circumference), from the garden of Mr. H. Newton of this town, nurseryman. The show of tulips was the most superb ever seen on the tables of the Society, there being nearly 250 exhibited for competition; and the whole exhibition excited the admiration of a very large assembly, consisting of upwards of 700 ladies and gentlemen in the course of the day. (*Ibid.*, June 6.)

The District Meeting of this Society was held June 5., when a variety of prizes were awarded. The Brompton stocks were the largest ever witnessed in that part of the country. (*Ibid.*, June 6.)

The Gateshead Ancient Florists' Society was held on May 28., when prizes were awarded to the following tulips: — Incomparable Briseis, Rose Ceres Primo, Triomphe de Lisle, Bien Fait, and Comte de Vergennes. (*Ibid.*, June 6.)

Hexham Botanical and Horticultural Society. — May 26. The exhibition seems to have consisted entirely of florists' flowers, for which various prizes, were given. (*Ibid.*, June 6.)

OXFORDSHIRE.

Oxford, Oxfordshire, and neighbouring Counties, Horticultural Society. — April 26. Amongst the articles most deserving notice were, a beautiful specimen of *Pultenæ'a stricta*, and *E'paeiris grandiflora*, shown by Mr. I. Wheeler, gardener to Mrs. Wall of St. Giles's; a *Camellia Sasangua*, a new hybrid *calceolaria*, and two varieties of *Kalmia latifolia*, by Mr. Fairbairn, gardener, nurseryman, &c. Broad street; a fine hyacinth, by Mr. White, Bicester; and a fine display of ericas, the property of Mr. Joseph Humphrey, nurseryman, &c., St. Giles's, with whom this beautiful and interesting tribe of plants bid fair to succeed better than they have hitherto done in this neighbourhood. (*Oxford University, City, and County Herald*, April 28.)

May 28. The show was good; and though there may have been more plants in the Hall, there were never more choice articles displayed at any previous exhibition of this Society. The tables occupied by the respective nurserymen were well filled with a brilliant display of the most choice and beautiful flowers the season could produce. Mr. Tagg and Mr. Bates displayed a fine collection of *pelargoniums*. Mr. Fairbairn and Mr. Humphrey excelled in the beautiful and interesting tribes of *Erica*, *Calceolaria*, and *Cactus*. Some fine *pelargoniums* were exhibited by Mr. W. S. Clark of Wallingford, which would probably have gained a prize, had not their bloom been damaged by travelling. As single plants which attracted most notice (exclusive of those exhibited for prizes) were, a very fine specimen of *Chenopodium humilis*, from the Botanic Garden; *Cereus speciosissimus*, *Calceolaria Yoongii*, *Houghiana*, bicolor, and some other fine and new hybrid varieties from Mr. Fairbairn; *Calceolaria Hopeana* and *polyantha*, from Mr. Humphrey; and *Onosma taurica*, and *Collinsia grandiflora*, from Mr. Jeffrey. (*Ibid.*, June 2.)

SOMERSETSHIRE.

Bristol and Clifton Horticultural Society.—April 17. The show of plants and flowers was very fine, and among the vegetables we noticed a curious specimen of the cockscomb broccoli from Malta, sent by George Sawyer, Esq. Prizes were distributed for hyacinths, polyanthuses, and auriculas; but the sorts are not mentioned. Nurserymen's prizes were classed by themselves; and we observe that they obtained a number for florist's flowers, pelargoniums, Cape heaths, and American and other hardy shrubs. (*Bristol Mirror*, April 21.)

May 24. Numerous prizes were adjudged for every description of garden production. The grand stand was exceedingly well filled with choice specimens of plants of all descriptions, particularly some very fine pelargoniums, from Mrs. Hugh Vaughan, Captain Langton, Mr. Norton, John Hurle, Esq., Mrs. Isaac Elton, Mr. Verney, Mr. Broomfield, T. Stock, and T. Daniel, Esqrs.; a fine plant of *Calceolària integrifolia* and *Cereus flagelliformis*, from C. George, Esq.; *Azalea indica alba*, John Hurle, Esq.; *Thunbergia fràgrans*, O. Fedden, Esq.; *Amaryllis psittacina reginæ*, *Ixia alba* and *maculata*, *Gladiolus Colvillii*, *Alströmèria tricolor*, *Boronia serrulata*, and *Kennèdia coccinea*, from H. Nugent, Esq.; *Cereus speciosus*, T. Daniel, Esq.; *Hibiscus Manihot*, Mrs. March Phillipps; Lemon, J. Prideaux, Esq.; very fine nectarines, grapes, and mushrooms, W. Gore Langton, Esq.; figs and grapes, R. Else, Esq. of Bath. The show of vegetables was very fine, particularly the asparagus and broccoli. We were glad to find that the nurserymen profited by the hint given them at the last show, as their stand was filled with choice plants. Mr. Miller, the secretary, also contributed in his usual handsome manner to embellish the stand. Cottagers received prizes for cabbages, potatoes, and nosegays. (*Ibid.*, May 19.)

June 21. There was a splendid display of ranunculuses, and the fruit and vegetables were extremely fine. Nine prizes were given to cottagers, for cabbages, potatoes, carrots, and nosegays. As usual, some rare and beautiful plants were exhibited by the nurserymen. (*Ibid.*, June 23.)

Bristol Florists' Society.—April 19. At this Meeting some beautiful flowers were shown; and Mr. Miller and Mr. Maule, both eminent nurserymen, obtained nearly all the prizes. (*Ibid.*, April 21.) We observe, in a subsequent paper, that *Cereus grandiflorus* was expected to bloom in Mr. Maule's nursery on the night of Monday, June 11., and that the public were invited to look at it. Such exhibitions always do good, by calling forth that latent love of nature which exists in every breast, though, like the buds of a plant, it may long lie in a dormant state, and even perish without expanding, unless fostered by favourable circumstances.

Taunton Horticultural Exhibition.—May 8. The display of flowers was beautiful in the extreme; they were, for the most part, exotics. There were some splendid specimens of the *Cereus speciosus* and *speciosissimus*. The ericas were in extensive variety. The yellow and scarlet sparax excited much attention, as did also the *Azalea indica alba*, from the Rev. E. T. Halliday, which obtained the prize. The Rev. W. P. Thomas sent some magnificent single and double tulips. Mr. J. Young, the active and intelligent secretary to the Society, exhibited a fine specimen of the *Andròmeda polifolia*, a heath plant from the Turf Moor near Bridgwater, and a large collection of other flowers. There were two specimens of the *Verónica rèpens*, a green plant with a low white flower, having the peculiar appearance of being splashed with whitewash. Of fruits there was necessarily but a limited supply, and they were all forced. Dr. Metford sent some very fine lemons; and the early sweetwater grapes, from Lady Hale's, were not without their admirers. Of vegetables there was a most profuse

display. The broccoli, kidneybeans, cucumbers, asparagus, sea-kale, rhubarb, and cabbages, were the most remarkable for their extraordinary growth, and excited much attention. (*Taunton Courier*, May 9.)

June 15. The floral display was exceedingly attractive and beautiful, whilst, the advanced state of the season allowing the introduction of outdoor fruits and vegetables, they were exhibited in the most tempting variety. The company present was of the most fashionable description, and the attendance of young and elegant females very numerous. We regret to hear that on this occasion several cases of pilfering from the rarest plants were observed. Due care, we understand, will be taken at the next Meeting to prevent a recurrence of so truly *English* a misdemeanour. The French, with all their frivolity and thoughtlessness, have deservedly the credit of being most exemplary in their conduct at exhibitions of this sort. (*Ibid.*, June 20.) As the aristocracy thus appear to steal now and then for amusement, it seems but just that they should show a little fellow-feeling to the mobocracy, when they steal from necessity.

SUFFOLK.

Ipswich Horticultural Society. — April 3. Various fruits preserved through the winter, green-house plants, forced flowers, and culinary vegetables, especially broccoli, obtained prizes. (*Suffolk Chron.*, April 7.)

The *Ipswich Annual Show of Auriculas and Polyanthuses* was held, May 3., when our correspondent, Mr. Woollard, one of the first growers in England, obtained the first prize for Gorton's Champion and Grimes's Privateer. Various other prizes were given. (*Ipswich Journal*, May 12.)

The *Beeches Horticultural Society* held its first Meeting, May 9., when various prizes were given for flowers, including nineteen superb hyacinths, some choice varieties of heartsease, and a double polyanthus, unique and of great beauty; cucumbers; strawberries; and a bunch of asparagus of fifty-one heads, weighing 4 lbs. 10 oz. (*Ibid.*, May 12.)

WILTSHIRE.

The *Wilts and General Arboricultural, Horticultural, and Botanical Society*. — April 10. A number of finely grown specimens of rare plants were exhibited, as well as florists' flowers, fruits, and culinary vegetables. Among the stove plants, we observed *Euphòbia splendens*, *Brunfelsia uniflora*, and *Cnretiligo simatrana*. We were glad to see several prizes given to cottagers, for cabbages and onions. — *Matt. Thos. Rodding, Hon. Sec.* April 16.

May 18. A still more splendid collection than before, of flowers, fruits, and vegetables, was exhibited; but only the names of a few that obtained extra-prizes have been sent us. Seven prizes were given to cottagers. Among the extra-prizes is one "to A. B. Lambert, Esq., for a new *Ribes*." This, we suppose, must have been the *Ribes speciosum*, a dried specimen of which was lately exhibited by Mr. Lambert at the Linnæan Society: its flowers are almost as beautiful as those of the *Fuchsia coccinea*, to which they have a general resemblance; its shoots are thickly covered with prickles; and the day is perhaps not far distant, when it may form the hedges of our cottage gardens, strengthened with a few plants of double sloe, and varied by the double whin and the blush *Cydonia japonica*.

June 19. Our correspondent, Mr. Shennan, is, as usual, the principal exhibitor of rare and finely grown plants; but the first prize was given to Mr. Mitchell for *Oncidium flexuosum*: prizes were also given for *Cymbidium aloifolium*, *Calanthe veratrifolia*, *Alstromeria psittacina*, *A. Simsii*, and *Panacratium calathinum*. Prizes were given to cottagers, for peas, potatoes, lettuces, rannunculuses, and Brompton stocks. Among the extra-prizes was one to Mr. Christie, gardener to Lord Radnor, for forbidden

fruit; and another to the Hon. Mrs. Harris, for *Canna discolor*. *Ceanothus azureus*, *Cycas revoluta*, *Alströmëria pulchëlla*, and *Arreumbërgia*[?] *diffusa*, are said to have attracted general attention.

WORCESTERSHIRE.

Worcestershire Horticultural and Floral Society. — *April 25.* Among the plants which obtained prizes were the following:— *Epiphyllum speciosum*, *E'pactris grandiflora*, *Aphelëxis fasciculata alba*, *Azalea indica purpurea*, *Polýgala cordifolia*, *Acacia armata*, and *Camëllia japonica* var. *alba flore pleno*; *Erica vestita fulgida*, *aristata*, *hybrida*; *Pittnia fruticosa* [?], *Sutherlandia frutescens*, *Gazania rigens*, and *Mimulus luteus*.—*Berrowe's Worcester Herald*, May 26.

May 22. The display of tulips was particularly fine; there were but few ranunculuses, but upwards of one hundred fine pelargoniums, and a variety of other hot-house, green-house, and hardy plants, with forced fruits, and a dish of potatoes grown in the open ground. (*Ibid.*, May 26.)

YORKSHIRE.

The Hull Floral and Horticultural Society. — *May 24.* The show of tulips was truly splendid, far surpassing any previous exhibition of that flower ever witnessed in Hull. There was also a great variety of pelargoniums and other green-house plants, as well as of culinary vegetables. (*Hull and Rockingham Gazette*, May 26.)

At a meeting of the *Ripon Horticultural Society*, held lately, a most beautiful and curious polyanthus, from the garden of Mr. Thomas Jackson of Ripon, was shown, which had attained an extraordinary size, its principal stem being 2 in. in breadth, and supporting 187 flowers. Mr. Jackson has another of the same kind at present in his garden, bearing about 160 flowers. (*Newcastle Courant*, June 6.)

WALES.

The Glamorgan and Monmouthshire Horticultural Society. — *April 25.* A great variety of fruit, vegetables, and flowers was exhibited, and a number of cottagers' prizes awarded. (*Cambrian*, May 5.)

The Abergavenny and Crickhowel Horticultural Society. — *May 11.* Stove, green-house, and hardy plants received prizes, besides florists' flowers, fruits, and culinary vegetables. (*Ibid.*, May 19.)

SCOTLAND.

The *Ribes sanguineum* is becoming more generally known. In the *Scotsman*, April 25., is a paragraph speaking of the beauty of the one in the Royal Botanic Garden at Inverleith; and the *Fife Herald*, May 3., mentions one in the Earl of Rosslyn's garden at Dysart, which, though only four years old, is 18 ft. in circumference, and 6 ft. high, having 836 clusters of flowers, each consisting of 24 or 36 long tubular florets of a deep rich scarlet.

The Caledonian Horticultural Society. — *May 10.* At the Meeting of the Council of this Society ripe specimens of the loquat were presented and tasted. This was produced on the back wall of a vinery, in the garden of George Robertson, Esq., of Greenock, under the management of Mr. Robert Guthrie. A handsome seedling plant, raised from seeds ripened there two years ago, was also presented. Several branches of *Rosa Banksiæ*, profusely covered with clusters of small white roses, were exhibited. These were from Balmuto, the seat of Mrs. Boswell. In a letter which accompanied them, Mr. Macculloch, the gardener, mentioned

that the plant grows outside the conservatory, but is led through an opening in the wall into the interior, where it covers a space of 135 square ft., completely occupying four rafters and sashes, and every shoot bearing from six to twelve trusses of roses: the whole appears one sheet of flowers. A beautiful flowering plant, of the yellow variety of the Banksian rose, was placed on the table in its flower-pot; and the singularity of its saffron-coloured flowers attracted much notice, they having never before been seen at Edinburgh. This specimen was from the rich collection of Professor Dunbar, at Rosepark. At the same Meeting the secretary announced the arrival, at the experimental garden, of a remarkable novelty in the department of ornamental forest trees. This was a live specimen of the weeping Turkey oak, from the botanic garden of Amsterdam. The deputation of the Society had remarked the mother plant in that establishment so long ago as the year 1817; and Mr. John Mitchell, junior, of Leith, having had occasion to visit Holland this spring, conveyed an application to M. Ptiester, the curator, who kindly presented an inarched plant, 4 ft. high, to the Society. An honorary medal was voted to Mr. Mitchell, for the great zeal and assiduous attention he had displayed in conveying this interesting specimen, in perfect safety, from Amsterdam to Inverleith. (*Edinburgh Advertiser*, May 22.)

June 7. The prize offered for the best seedling China rose was awarded to Mr. John Macnaughton, gardener to John Wauchope, Esq., of Edmonstone. The seedling was exhibited; it was fragrant, and of a beautiful pale colour, with large, though not very regular, petals. A sample of ripe May Duke cherries was handed round; they were from a flued wall at Erskine House garden; and a letter from Mr. Shiells, gardener there, was read by the secretary, describing the mode of management, and showing that early cherries may very successfully be procured from flued walls. On the table were placed several specimens of showy shrubs, from the experimental garden of the Society; and also samples of what is called Prussian grass, being the unexpanded flower-stalks, and spikes of flowers, of the *Ornithogalum pyrenæicum*, used in the West of England as a substitute for asparagus. A Report from the Council of the Society was read, relative to a grand exhibition of exotic plants, to be held in the Society's garden, at Inverleith, early in July next. It stated that the erecting of awnings, benches, &c., yearly, cost a considerable sum; and recommended that a small fee should be taken at the gate, to defray these necessary expenses. This proposition was unanimously approved of; and the Meeting agreed, that, at the July exhibition, the sum of 1s. be paid by every individual entering the garden; it being farther necessary that strangers be provided with orders from members. (*Ibid.*, June 12.)

ABERDEENSHIRE.

Aberdeenshire Horticultural Society. — May 1. Prizes were awarded for auriculas; the names of the three which obtained the first prize are not given, but the second best were Moore's Ceres, Lee's Venus, and Grimes's Privateer. Various other prizes were given for flowers and fruits. (*Aberdeen Chronicle*, May 5.)

EAST LOTHIAN.

The Ancient Fraternity of Gardeners of East Lothian. — April 10. Prizes were adjudged for vegetables and preserved fruits, but the particulars are not given.

The East Lothian Horticultural Society. — June 6. Our correspondent, Mr. Pearson of Ormiston Hall, obtained the first prize, for sixteen sorts of poppy anemone; and the second was given to another of our correspondents, Mr. Ferme of Haddington, for the six finest herbaceous plants, viz.

Pancrätium illýricum, Lupinus polyphýllus, Gèum coccíneum, O'robis varius, Scilla peruviana, Pædönia officinális var. ròsea.

FIFESHIRE.

Cupar Horticultural Society. — April 25. Prizes were awarded for aurículas, polyanthuses, hyacinths, and other spring flowers; but the names of the varieties are not given. Prizes were also given for broccoli, sea-kale, leeks, &c. The leeks were extremely fine, and grown on ground manured by common salt. We have previously noticed these circumstances in p. 373.

LANARKSHIRE.

Glasgow Horticultural Society. — June 6. The show of hot-house and green-house plants, for competition, greatly exceeded, both in quantity and splendour, any former spring meeting; but, from the backwardness of the season, the display of azaleas, kalmias, and rhododendrons fell short of what otherwise would have been expected. As usual, the exhibitors were numerous. From Woodhall, bitter orange in fruit, *Cèrus speciosíssimus*, *Cèrus Jenkinsonii*, *Caméllia japonica* var. álba, several fine ericas, pelargoniums, &c., for which an extra-prize was awarded. From Drumpellier, a fine plant of *Cèrus speciosíssimus*, fruit of the citron. From Èrskine House, ripe cherries from the open wall, with the occasional application of heat after blossom, basket of strawberries, pears, &c., for which an extra-prize was awarded. From Kilmardinny, several bundles of ripe grapes, and several peaches well ripened. From Craigend, celery sown on the 2d of January, and ridged out on the open border on the 15th of March, fine leeks, &c. From Castle Toward, an excellent display of vegetables. From Bothwell Castle, many very fine varieties of calceolarias, raised from seed saved by Mr. Turnbull in 1831, some of which are expected to be hardy. From Messrs. Brown, seventy varieties of double daisies, raised from seed sown in 1831, early tulips, &c. From Messrs. Cowan and Co., new variety of scarlet-flowering thorn, of a deeper shade, and freer flower [this is probably the *Cratægus Oxyacantha ròsea supérba*, exhibited June 5. at the London Hort. Society's show, see p. 505. and 507.]; also, *Méspilus chinénsis*, a fine ornamental tree, with a profusion of exotics and flowering shrubs in pots. From Mr. Stewart Murray, botanic garden, as usual, an immense display of cut flowers in bouquets, and a host of hot-house and green-house plants, fine specimens, too numerous for specification. Among the most interesting articles exhibited, which excited great attention, were three stocks of celery, grown at Craigend, by Mr. James Ross, gardener there, and sown on the 1st of January; the first this season, and considered the earliest ever shown before the Society. A quantity of superior green peas, grown at Newton House, by Mr. Somerville, gardener there, a new species, entitled Lewisham; early dwarf cabbage from Killermont; and a quantity of excellent grapes and peaches from Kilmardinny. There were in all fifty-four lots of articles entered for competition; a proof of the great spirit of emulation which has lately prevailed among the Glasgow practical horticulturists. (*Glasgow Herald*, June 8.)

MID-LOTHIAN.

The North British Professional Gardeners' Society. — April 11. Prizes were given for polyanthuses, hyacinths, aurículas, and vegetables. The latter were very fine; the broccoli which gained the first prize measured 17 in. in circumference. The prizes are not given, as the sorts gaining them are not particularised. (*Scotsman*.)

RENFREWSHIRE.

The West Renfrewshire Horticultural Society. — May 30. The attendance was numerous, and a number of prizes were awarded. Among the

green-house and hot-house plants were, *Calceolària integrifòlia*, *Erica prægnans major*, *E. ventricòsa*, *Aphelèxis humilis*, *Marànta zebrina*, *Agapànthus umbellàtus*, *Gloxínia speciosa* and *caulescens*. (*Greenock Advertiser*, June 8.)

STIRLINGSHIRES.

Stirling Horticultural Society. — *May 1.* The various productions were, as is generally the case, first rate. Among the flowers sent for competition, the auriculas and hyacinths were especially admired. The parcel of self auriculas, which took the first prize, was exceedingly beautiful, and very far superior to any of the kind which had been previously seen in Stirling. We are glad to perceive that many persons who do not compete, as well as those who do, present labelled specimens of choice plants for exhibition, a practice which cannot be too highly commended; and of these we select the following, as a few of the most striking: —

From Castle Toward, Argyleshire, two bunches superior asparagus; four sulphur broccoli, remarkable for size, heaviest 5 lbs.; six flag leeks, weighing in the aggregate 10 lbs. From Blairdrummond, *Amaryllis formosissima*, in flower; *Hermànnia althæafòlia*, *Streptocàrpus Réxii*, pelargoniums, ericas, *Aloë verrucòsa*; Seville oranges in fruit; also, six flag leeks, 9 in. blanched, and 6½ in. round the bulb. From Dollar Botanic Gardens, a basket of exotics, including double red Warratah camellia, Cape heaths, &c. From Keir, three large potted double stocks, in flower; *Fúchsia microphýlla*, *Cinerària populifòlia*, *Fritillària imperiàlis* (two varieties), *Richàrdia æthiòpica*, ericas, Chinese roses, &c.; also, a basket of excellent mushrooms. From Tullyallan Castle, a basket of exotics, including *Azàlea índica* of sorts, *Cèreus phyllanthòides*, a fine collection of Cape heaths; also, auriculas, double wallflower, violas, &c. From Wester Plean, a beautiful flowered branch of *Ribes sanguineum*, double primroses, &c. From Viewfield Lodge, a collection of flowered specimens of rare shrubs and herbaceous plants. From Craigforth, a parcel of particularly well preserved apples. From Comely Bank, two handsome plants of *Acàcia verticillàta*, well flowered. From Messrs. Drummond's nurseries, several hardy and tender plants, in pots, profusely flowered, comprising rhododendrons, calceolaria, *Azàlea índica*, pelargoniums, polyanthus, narcissus, &c.; also labelled specimens of American shrubs, herbaceous plants, Taylor's forty-fold potatoes; likewise, a crystal globe, containing live gold and silver fishes (adapted for gardens and cisterns). These gay and glittering specimens of the finny tribe were much admired. (*Stirling Journal*, May 10.)

June 12. Numerous prizes were awarded for ranunculuses, Chinese roses, pelargoniums, American shrubs, and culinary vegetables. An extra-prize (a copy of Nicol's *Planter's Calendar*, or its value) having been offered by Mr. P. Drummond, seedsman, to the person, whether a member of the Society or not, who would produce at this Meeting the best model of a moss-house, of his own construction, and not exceeding 2 ft. in height; a spirited competition took place; when the judges, after a most minute inspection, decided in favour of Mr. William Wilkie, apprentice gardener at Keir; the next in merit was adjudged to Mr. William Moir, gardener at Comely Bank; and the third to Mr. William Kay, Shiphaugh. All the models brought forward were excellent (that from Mr. Moir was universally and deservedly admired for its internal elegance and high finish), and while they contributed very materially to the interest of the exhibition, reflected great credit on the taste and ingenuity of the competitors. As it often comes in the way of gardeners and foresters to design and execute these useful and highly ornamental structures, it is hoped the subject will not be lost sight of by the Society. Besides the articles produced for

competition, there were interesting and appropriate assortments presented for exhibition. From Gartur (including splendid specimens of *Magnòlia tri-pétala*, from a standard tree 15 ft. high, and ornamented with 100 large flowers), Kippenross, Blairdrummond, Boquhan (including a *Schizánthus pinnátus*, in pot, 5 ft. high, and profusely flowered), Comely Bank (including eight magnificent double giant Cape and Brompton stocks in pots), Craighforth, Tullyallan Castle (including twenty-one varieties of *Rhododéndron* raised from seed by Mr. Gow, gardener there), Viewfield Lodge, Shiphaugh, Coney Park nurseries (including collections of Scotch roses and double anemones), Mr. Christie, Causewayhead, and from Mr. Wyse, Falkirk. (*Stirling Advertiser*, June 15.)

Messrs. W. Drummond and Sons, nursery and seedsmen, Stirling, have announced that their exhibition of agricultural productions, for 1832, will be held from the 16th of November till the 15th of December, inclusive. As the whole effect of the exhibition will depend on the means afforded of minute and accurate comparison, not only of the productions themselves, but also of the means employed in their cultivation, Messrs. Drummond and Sons recommend that intending contributors note carefully the general nature of the climate of their district, its altitude, and position as to hills, &c., the nature and preparation of the soil, the quantity and sort of manure, the kind or variety of seed, the period of sowing or planting, the quality of the tid [time, English; viz., the circumstances of the soil and weather at the time of sowing and planting], with the periods and modes of working in drilled crops, and, as nearly as can be ascertained, the produce per Imperial or Scotch acre, adding, in grain crops, the weight per bushel or per boll. The whole to be written on labels attached, or on a sheet of paper having reference to the numbers of the respective specimens. Although the exhibition may be considered as local, Messrs. Drummond and Sons, with a view to the encouragement of the art in all districts, and for the more immediate purpose of bringing to the Stirling district a knowledge of what is doing elsewhere, respectfully invite amateur and practical agriculturists of other districts to favour them with specimens, and with their presence at the exhibition. Contributions may consist of any of the following, viz.:—Roots and Vegetables, Grain, Manufactured Produce, Grasses, Garden Produce, Implements, and any Specimens connected with Agriculture, and which cannot be classed with any of the foregoing, including New and Rare Seeds and Plants, also Communications, &c. It has been suggested, that, were the different varieties of each species or family of agricultural plants to be grown under the same circumstances, on the same ridge of land, and the results accurately noted, it would assist much in ascertaining their comparative value; and it may also be added that the obtaining of improved varieties, by means of artificial impregnation, or crossing, appears highly worthy of attention, much having been already effected in this way, in the practice of horticulture. (*Ibid.*, June 15.)

IRELAND.

The Horticultural Society of Ireland.—April 24. Prizes were distributed for plants, fruits, and flowers, but the kinds are not mentioned. From the whole exhibition it was evident that the horticulture of Dublin and its vicinity is very greatly improved. Among other new plants, we perceive our favourite, the *Ribes sanguíneum*, which appears likely to be as much admired in Ireland as it is already in the sister kingdoms.

List of exotics for which premiums were awarded:—Stove plants, by Mr. Mackay, of the College Botanic Garden: *Euphórbia spléndens*, *Euphórbia puníceá*, *Hæmánthus multífórus*, *Pancrátium speciósium*, *Epidén-*

drum cochleatum, and *Ixora coccinea*. Green-house plants, by the same: *Dryandra formosa*, *Liparia villosa*, *Gnidia denudata*, *Illicium floridanum*, *Lachenalia tricolor* (a new variety), and *Acacia verticillata*. Mr. Mackay also sent the following plants to ornament the stage, but not for competition: — Bourbon palm (*Latania borbónica*), papyrus of the Nile (*Papyrus antiquorum*) with stems 10 ft. high, *Camellia Sasánqua rosea*, together with a number of fine specimens of African heaths, amongst which was a splendid specimen of *Erica aristata* var. major. The following, from Mr. Keef, nurseryman, Longlane, obtained the second prize: — *Camellia japonica* var. florida, *Rosa mundi*, Gray's Invincible, and Carnation Warrah. These beautiful specimens are now, for the first time, exhibited in flower in this country. *Correa speciosa*, *Indigofera australis*, *Paeonia Mouatan*, *Cereus speciosus*, and *Pomaderris elliptica*, fine and well-grown specimens; as were also the heaths and pelargoniums, for which premiums were awarded to the same person. The following beautiful plants, sent in by Mr. Grant, gardener to George Putland, Esq., Bray Head, obtained the first prize for "exotics from private gardens:" — *Hovea Celsi*, *Eutaxia pungens*, *Azalea indica* var. purpurea and alba, *Dryandra formosa*, *Indigofera australis*, and *Grevillea Baüeri*. The following, sent in by Mr. Nevin, gardener to the chief secretary, obtained the second prize in the above class: — *Hovea Celsi*, *Boronia pinnata*, *Boronia serrulata*, *Brachysema latifolium*, *Platylobium triangulare*, and *Chorozema Henchmannii*.

Two splendid camellias (*atrórubens* and *Sasánqua*), a citron, a pomegranate, and some fine hybrid amaryllises, from seed saved in the country, were also well deserving of notice; and the whole indicated, we are happy to learn, rapid improvement in the horticulture of the vicinity of Dublin. (*Dublin Evening Post*, April 30.)

Belfast Horticultural Society. — April 16. Among the prizes the following are the only ones that have the varieties named: — Auricula, Green-edged, Stretch's Emperor Alexander, Mr. George McCulloch. Camellias, Myrtle-leaved, Mr. McCulloch. Purple Noisette Rose, Mr. John Scott. *Acacia verticillata*, Mr. Samuel Milliken, gardener to Sir R. Bateson. White Camellia, Mr. G. McCulloch. Pine (Enville Queen), Mr. Lewis, gardener to Colonel Forde. *Illicium floridanum* and *Salvia cardinalis*, John Stott, Esq. (Mr. H. Glen, gardener). The marked improvement observable between this show and the spring show for 1831, must give great satisfaction to the friends of the Society. (*Northern Whig*, April 19.)

May 21. At this show there appeared such a manifest and decided improvement over former years, as clearly to evince that the Belfast Horticultural Society may now vie with any other in the United Kingdom, and has been productive of much benefit to the country. The geraniums were extremely beautiful. There was also a very fine selection of anemones, tulips, and other green-house plants and exotics, and a great variety of vegetables, melons, strawberries, &c. A great number of rare plants and fine vegetables were on the table; among them we noticed the *Thomasia solanacea*, from John Stott, Esq.; double-flowering tea plant, and a number of others, Mr. E. Lindsay; a number of fine ranunculuses and fine early lettuce, from R. Moore, Esq.; *Azalea coccinea*, from Mr. G. McCulloch; six varieties of calceolaria, from Mr. Scott, Ormeau; the creeping cereus, G. Andrews, Esq.; *Agapanthus umbellatus*, and *Cereus speciosus*, Sir R. Bateson, Bart.; and, though last, not least in merit, a fine specimen of wheat, grown by A. J. Macrory, Esq. Duncairn. (*Belfast Commercial Chronicle*, May 23., and *Belfast Guardian*, May 29.)

THE
GARDENER'S MAGAZINE,
DECEMBER, 1832.

ORIGINAL COMMUNICATIONS.

ART. I. *Remarks relative to the Advice given by Mr. Mallet to Young Gardeners.* By SCIENTIÆ ET JUSTITIÆ AMATOR.

Sir,

I HAVE felt much pleasure in reading the last Number of your Magazine, not merely on account of the matter it contains, but also because several of the communications have been sent by individuals whose station in life enables them to be the supporters of horticulture and rural improvements. The progress of the art of gardening, although depending much on the exertions of its operatives, and the power possessed by the rural population of bettering themselves; yet, as circumstances are constituted at present, cannot be expected to make great advances without the friendly cooperation of the wealthier classes. It is to them that the eyes of the peasant are directed for the amelioration of his situation; and to them that the persevering scientific gardener looks for the remuneration of his toils and privations; and, therefore, every philanthropic measure recommended by them should be hailed with feelings of satisfaction and delight. But while I duly appreciate and feel grateful for their favours, I would also observe, that, as their station in life renders them incapable of knowing experimentally the state of those who are much their inferiors, so far as wealth is concerned, they are very apt to arrive at conclusions not only erroneous, but sometimes productive of results quite foreign from their intentions.

The last remark was forcibly impressed upon my mind, by reading the first three periods of Mr. Mallet's article (p. 521.),

where he says: — “Every young gardener, at the present day, ought to travel abroad,” &c. ; and that “a careful attentive young man could and ought to have saved 80*l.* by the time he is twenty-four years of age, with which he may remain three months on the Continent,” &c. What the means are which Mr. Mallet possesses of ascertaining the resources of young gardeners, I am ignorant of; but, as the pages of the Magazine are open to discussion, I take this opportunity to contradict the accuracy of his statements; believing experience to be as good, if not a better, standard to judge from than the strictest observation. I do not deny that the individual who remains long in one establishment, where he may have the privilege of receiving useful books to read, may and ought to save a little money; but, in the generality of circumstances in which young men are placed, those who are anxious to secure thorough knowledge of their profession move about from one celebrated establishment to another, and from their slender incomes purchase some of those volumes which they consider necessary for explaining the practice and principles of their art. To young men thus situated, these doctrines of Mr. Mallet are not only unreasonable, but almost as remarkable for their apparent impossibility of application, as a mathematical axiom is for its incontrovertible truth. If the Magazine were read by gardeners only, the very attempt to contradict assertions so manifestly erroneous would be an insult to their understanding, and equally as foolish as if I were endeavouring to convince them that the sun did shine, at the very moment they were basking in his enlivening beams. But since the Magazine is subscribed for and read by many of the employers of gardeners, it becomes a matter of some importance that they should remain under no misconception or delusion relative to the true situation in which young gardeners are placed; for, according to Mr. Mallet, instead of having difficulties to contend with, we possess the means of soon arriving at comparative independence. I freely allow that in many gentlemen's gardens the young men are pretty comfortable; but, without fear of contradiction, I likewise assert, that in general we have more privations to submit to than any other class of men. To be convinced of this, it is not necessary to run over a long list of the disadvantages under which we labour; since the scantiness of our pecuniary resources, and the attainments in knowledge we are required to make, will be quite sufficient for any open unprejudiced mind. Journeymen's wages seldom exceed, and are frequently lower than, those of the common labourer, who has had no set time to serve, no apprentice fee to pay, and no expensive journeys to

take in moving from one establishment to another. I lately worked in a nobleman's garden near London, and the wages I received were three shillings a week less than was paid to the ploughmen at the farm, independent of their lodgings and other privileges, which would, at least, make their wages one third more than those received by a young gardener; and, moreover, incredible as it may appear, it is no less true, that there is scarcely a boy in a gentleman's stables, or a servant girl in his house, but receives about as much money for board wages as the journeyman gardener does altogether. Surely if, in these circumstances, it were possible to save so much money as Mr. Mallet speaks of, we cannot err in coming to the conclusion, that want and misery are always the concomitants of inattention or carelessness. If Mr. Mallet had known experimentally what he treats of theoretically, he would have found, as I have done, that the strictest carefulness and economy are absolutely necessary to enable us to appear moderately respectable, and defray the expenses unavoidably incurred in prosecuting the attainment of professional knowledge.

With regard to Mr. Mallet's first statement, that every young gardener ought to travel abroad; I should consider it as advisable, allowing him to have a little money, first to take a tour through his own country. If my means allowed it, I should be very desirous to visit the Continent, as few things are better calculated than travelling for expanding the mind: but, would it not be the height of folly for any man, to spend what little money he may have rigidly saved upon such an undertaking, with no better prospects, when he returned, than that of being without employment, or of receiving a compensation for his labours barely sufficient to support him in existence? If gentlemen were desirous that their gardeners should be thus highly accomplished, and would esteem and reward them accordingly, men would be found making every sacrifice to obtain the necessary acquirements: but it is in vain that you endeavour to advance the profession by extending the necessary qualifications of its operatives, or that your correspondents address you on the necessity of our exerting ourselves to obtain knowledge, if so little attention is paid to these things by the employers of gardeners, that we often see men of good abilities passing through life in obscurity, and, in first-rate establishments, individuals not more remarkable for their haughtiness and pride, than for their want of intellectual accomplishments. In the acquiring and in the possession of useful knowledge, there is doubtless a realisation of happiness; but a thirst for general and scientific information

will never be so prevalent among us as it ought to be, until a man can perceive clearly that these attainments are absolutely essential, as the means by which he must arrive at preferment and respectability. Much as I would wish to see the art of gardening arrive at something like perfection, and convinced as I am that this will most effectually be brought about by the indefatigable exertions and scientific investigations of its professors, I am not sanguine enough to believe that men possessing those high accomplishments so frequently recommended, will remain at a profession which they see rapidly losing the patronage of its supporters, and in which they would be less respected, and receive less remuneration for their labours, than other servants in a gentleman's establishment, who had experienced neither trouble nor expense in cultivating their intellects, or acquiring the knowledge of their occupation. I have extended these remarks to double the length I intended; but I place them at your disposal, to do with them as you think proper, informing you, at the same time, that, in publishing them, you will give publicity to the general sentiments of gardeners on this subject, as far as I have been able to ascertain them from observation and experience. I shall only say, in conclusion, that though I always feel much pleasure in reading Mr. Mallet's communications, I trust that, when he writes again upon the duties and resources of young gardeners, he will take a more extended view of the circumstances in which they are placed, and not confine his observations to solitary cases, as his ill-grounded statements manifestly show he has hitherto done; and in the mean time I remain, &c.

SCIENTIÆ ET JUSTITIÆ AMATOR.

Staffordshire, October 15. 1832.

THE evils of which our correspondent complains are undoubtedly great, and they cannot be remedied speedily. The immediate cause of them is the superabundance of young men ready to become workmen in gardens, and the ignorance of the employers of gardeners of the greater value, both professionally and morally, of a reading and scientific gardener, than of a mere empirical practitioner. The possessors of gardens generally, notwithstanding the considerable number of well managed gardens which they may observe in the country, and the various books from which they may derive instruction on the subject, are by no means aware of the extent of the comforts, and of the elegant enjoyments, which a garden is calculated to afford, otherwise they would be much more select in their choice of gardeners, and not grudge them better wages than they are now paid. Those same persons, however, are well aware how much of their domestic ease and happiness depends on their having a good cook, a careful house-keeper, an honest butler, and decent, cleanly, well-behaved in-door servants of every description; and therefore they pay these domestics

comparatively well, in order that they may be able to afford to be honest, intelligent in their different businesses, cleanly in their persons, and well-behaved in their manners. On the same principle, as country gentlemen and their families acquire more knowledge of botany and gardening, they will desire to have a superior description of gardeners; and, when this is the case, they will pay them better. In the mean time, the journeyman gardener must consider, that, though he is worse paid than a common labourer, yet his prospects in life are greatly superior to those of either a labourer or a common in-door servant, neither of whom, generally speaking, can ever hope to rise much above their original sphere; whereas the gardeners, like the members of every other profession requiring mind, rise by system, and from the humblest situation may attain the highest degree of eminence. So much for the immediate causes of, and temporary consolation for, the grievances complained of by our correspondent. The fundamental causes of these grievances lie wide and deep, and apply to every class who live by their bodily labour. What is the reason why the ploughman, though better paid than the journeyman gardener, yet eats, drinks, and lodges in a very inferior style to his employer, the farmer? What is the reason why the farmer can barely pay his rent and exist? What could the landlord do without the farmer, the farmer without the labourer? or the country gentleman without his gardener and other servants? Is not the obligation in all these cases mutual? Undoubtedly it is, in the abstract; but practically it is not so: for it is found that there are always more servants than can get employment at good wages; and more farmers than can get farms at reasonable rents. What, then, is to be done to remedy this evil? Simply to adapt the supply to the demand. All the difference which now exists between the degree of comfort enjoyed by the employer and the employed, between the landlord and the tenant, the borrower and the lender, are owing to the discrepancy in this respect; and this discrepancy essentially springs from the ignorance of the one, and the comparative knowledge of the other. If there are examples of ignorance among the employers, the landlords, or the lenders, yet these are not sufficient to hinder them from acting as a body or whole in rewarding labour; and if there are individuals among the employed fully enlightened, yet these are too few to influence their class, as a body, in withholding labour till it shall receive its adequate reward. For the effectual removal, therefore, of all the evils complained of by our correspondent, we must look to the rising generation, and only to that generation on the supposition that an efficient national system of education is without delay established. It is the duty of all who are of this opinion to impress it on the minds of all. — *Cond.*

ART. II. *The Necessity and Advantages of Gardeners visiting one another's Gardens.* By R. T.

Sir,

You will probably recollect that, some time ago, I promised, after paying a visit to some of the gentlemen's seats within my reach, to give you an account of the manner in which I treated some kinds of plants, which appeared to me to attain a greater degree of perfection under my mode of culture than under that of others. This promise I have already in some measure fulfilled, but not to the extent I intended, owing to a multiplicity of business, and other circumstances, which pre-

vented me from devoting sufficient time to the subject. I hope, however, at a future period to, occupy a few more of your pages for the same purpose. I have just now returned from another ramble among my friends, the benefit of which I always find so great, that, although it has been before recommended in your valuable work, I cannot well refrain from again calling the attention of gentlemen to the importance of not only allowing their gardeners the privilege of visiting their neighbours, but also to urge them to do so, and to furnish them with the means. Could they but conceive the advantage derived from it, both as it regards the knowledge the gardener acquires from seeing the different manner of treating plants for various purposes, as well as the stimulus he receives to equal or excel others, I am certain there would be no occasion for my present remarks; but, when I hear of gentlemen objecting to spare their gardeners for a few days in a year for such a purpose, I think it is right they should be apprised of the advantage they would derive, if they were to adopt a different plan. If some one more able than myself had made an attempt, it might have had a greater effect; but with a little of your assistance, perhaps even mine may be productive of some good. I do not mean to say that a gardener is to be continually going from place to place, to the neglect of his business at home; nor will it often be found that a man who is anxious to excel others will neglect his concerns at home to visit his brother gardeners, as he will then have more reason to expect a visit from them, whose approbation in many cases he values more than that of his employer, his reputation being spread more about the country by the former than the latter. I would therefore suggest, that gentlemen should enable their gardeners to see (as far as practicable) the places where they are themselves in the habit of calling; as it would do away with many unpleasant feelings experienced by the gardener, as well as be beneficial to both in many respects. It is no uncommon thing for a gentleman or lady, possessing a first-rate gardener, when in the course of an airing they have seen something which struck them as far superior to their own, to return home dissatisfied with their servant, and wondering how it is that they cannot at least equal others in the display of flowers, or production of fruit, &c., without once taking into consideration the difference of soil or situation, the expense bestowed, or the means allowed to obtain the same. Persons are also very apt to take particular notice of a few things, which, from a different mode of culture, present such a different appearance from their own, that I have, in several instances, known cuttings and plants brought

home, when they have had the very same things growing in their own gardens at the same time. Thus, for instance, one person grows a quantity of some showy kind of plants in small clumps, which, when in flower, cannot fail to attract the attention of the most careless observer; while another, who has no small clumps in his garden, grows a variety of kinds together; and although he has the same sorts as another, yet, from the manner in which they are grown, a great part of them are not observed by a person merely walking through. When it thus happens, and the gardener is ignorant of what is passing around him, he cannot state the reason of the difference, and is therefore unable to defend himself: whereas, if it were otherwise, he might satisfactorily account for it, while his abilities would not be lessened in the eyes of his employers. There are many gardeners who would gladly spare a few days in a year for the purpose I have mentioned, but that in some cases the low wages they receive, and in others the unwillingness of their masters, prevent it. I believe it will generally be found, that, where a first-rate gardener is kept, there is at least one horse kept which might be spared on such occasions, and is very likely wanting exercise, while the servant is suffered to hire one, or to pay coach hire to a considerable amount for the benefit of the gentleman, who, if he were inclined, ought to do it for next to nothing, while the servant, sensible of the kindness bestowed, would not fail to return it by a strict attention to the things committed to his care.

I am, Sir, yours,

Aug. 1832.

R. T.

ART. III. *Directive Hints for the effective Cultivation of Cottage Gardens.* By SELIM.

Sir,

IN a former communication (p. 529.), I ventured to offer a few remarks upon the subject of cottage allotments, and then confined my observations to the quantity of land that a labourer might probably cultivate with profit to himself, and without inconvenience to the master who employs him. I believe I contended that few men in constant work could manure and cultivate more than half an acre: but supposing a man could cultivate that quantity of land, the next thing to be considered is, how could he manage it with the least expense of labour, and to the most advantage? In this respect, it will be found, that the common run of labourers require a good deal of advice and instruction. Those acquainted with the habits

of the labouring classes are aware that their knowledge of gardening is very much confined, and that, generally speaking, they have no taste for any thing beyond the common kinds of vegetables. In this parish I seldom observe any thing in a cottage garden but potatoes, cabbages, beans, and French beans; in a few instances onions and parsneps, and very seldom a few peas. Cabbages are the favourite vegetable, and the prevailing crop in our cottage gardens; and, for winter greens, I generally find a plot of rape, which they transplant from the fields, and it is said to be very productive, and to make excellent greens. Bacon is the meat they use, and they cultivate the sorts of vegetables which eat best with it. To show how little taste the labouring classes have for the better sorts of vegetables, I will mention, that having, on one occasion, more red beet than I could use, I gave a quantity to a man who works for me, desiring him to have it boiled, and to eat it with vinegar with his bread and cheese. As he did not mention it for some time afterwards, I concluded it was not liked; and upon enquiry I found that all the family tasted it, and all disliked it, on account of its sweetness. I said, "Then, of course, you gave it to the pig?" "Oh no," was the reply, "I did not give it to the pig; I was afraid it might do it harm." And although I assured him that I had seen pigs kept in very good condition upon the same sort of thing (mangold wurzel), I could not prevail with him even to give the pig a taste. I have found the same dislike for spinach, which Cobbett praises and recommends so highly, and for many other vegetables which are considered as luxuries by the upper classes.

Supposing, then, that a labourer had half an acre of ground, one fourth of that quantity would be sufficient to produce his vegetables, except potatoes, as they always crop close, and seldom leave any part vacant; the next question is, how is he to crop the remainder? Some would say, with potatoes. I should say, with potatoes and grain, either wheat or barley; and for this reason, because the straw of the grain would litter the pig, and be returned in manure upon the land. Besides, I think that the chief use of allotments of land is to enable the labourers to keep pigs, and eat more meat and fewer potatoes; and a labouring family, to live as they ought to live, should kill two pigs in the year. Let us suppose, then, that the remaining three fourths of the half acre of ground be divided into two parts, and cropped alternately with grain and potatoes, manuring always for potatoes. There would, in this case, be generally plenty of potatoes for the use of the family, leaving some also for the pigs: the grain, if it were barley,

would assist in feeding the pigs ; if wheat, it would supply the family with bread for a certain time, and while they used their own wheat, that part of their earnings which they saved in bread they could afford to expend in barley for the pigs. The plan of sowing grain would have also this advantage, that it would diminish the quantity of labour required. When the potatoes are taken up in autumn, the haulm might be previously removed to the dung-heap, and the ground neatly dug and left to mellow till the spring, when it would require little labour to fork in a crop of barley. And if the land were to be sown with wheat, it might be done by a method which I learned, I think, from the *Report of the Society for bettering the Condition of the Poor*, and once tried myself for the purpose of convincing a labourer that it might be done ; for, simple as the method is, he would not believe it practicable till he had seen it tried. When the potatoes are to be dug up, mow and remove the stalks ; then, having dressed the seed, sow as much ground as you intend to dig in the day. The act of digging up the potatoes covers the seed wheat ; of course it must be dug neatly, breaking the clods, and picking out the rubbish as you proceed. The man above alluded to was persuaded that we should bury the seed so deep that it would never vegetate. His surprise was therefore great, when it came up at the proper time, and produced an abundant crop, and he afterwards followed the same method upon his own ground. When grain is once sown, it is done with, except a little weeding in the spring, until the following harvest, when it may be threshed with the gleanings : whereas potatoes, besides the labour of setting and digging up, require a good deal of attention in the busy time of the year ; indeed, it is a custom with our people to hoe and fork between the rows two or three times before the potatoes are taken up, and this has to be done generally in haytime, when the men work late, and have little leisure time. I am, therefore, an advocate for sowing some part of the allotment with grain, because it adds to the manure, diminishes the labour, and would assist greatly in feeding a pig : indeed, the produce of the barley plot, added to the gleanings of an industrious family, would be quite sufficient to fatten a large pig.

You will perceive that my observations on cottage allotments (p. 529.) refer especially to parishes which have not any considerable surplus of labourers, as is the case in the district where I reside : still, as the wages are not sufficient to support a large family in decent comfort, the labourers, even here, stand in great need of the assistance of land. In parishes burdened with many unemployed labourers, I read

of allotments being made to the extent of three and four acres, and I fear these allotments will not answer in the end, if used as arable, because the land will be in constant work without manure. In the case of large allotments, an acre of arable land is quite as much as any man can manage properly, if he has any employment besides; the remainder should only be in grass, to support a cow. Upon this plan the grass and arable would mutually assist each other, and might afford a maintenance for a family.

I am, Sir, yours, &c.

August 17. 1832.

SELIM.

ART. IV. *On the Influence of Cottage Gardens in promoting Industry and Independence among Cottagers.* By JOHN H. MOGGRIDGE, Esq.

Sir,

It is a fact, the knowledge of which will not be unacceptable to those of your readers who take an interest in plans for bettering the condition of the poor, that, in the village of Blackwood, ripe peaches grown in a cottager's garden have this season been sold at the moderate price of 8*d.* per dozen. I need hardly say that the land producing this fruit was the grower's own, that is, held under a lease for lives. In the year 1817, this spot was a wilderness, and the present occupier was one of the first adventurers in the experimental colonies, founded in 1818, of which you have repeatedly inserted some account in your valuable Magazine. For the first settlers I cleared the ground at my own expense, and some other trifling assistance was given in the beginning of an undertaking then much scoffed at, and since occasionally thwarted, by persons who desire to see but two classes of people in the country, the rich and the poor, the master and the servant, the oppressor and the oppressed. The cottager, whose garden has produced several dozens of peaches this year, was a rough or out-of-door carpenter, employed to put up posts and rails on a farm, and to do the rough work about a colliery. Before he built his house, he lived in a hovel, with his wife and family, without even a garden. Since then, by dint of his industry and good conduct, he has been enabled to build a second and a third house, all of stone, and tiled, and to bring three gardens into cultivation; besides rearing his children decently, and teaching his sons to tread in his steps. He is now an old man, nearly blind, and has been unable to follow his work for more than a year past: but he has a

comfortable house to live in; receives the rent of two other houses; has two industrious sons and a daughter, unmarried, to cultivate his garden, which is larger than usual; with its produce in fruit and vegetables of various sorts, honey from his hives, and a pig in the sty to kill at Christmas, to console him under the loss of sight and the infirmities of old age, with the cheering consciousness, that he need be indebted to no parish for relief, and is in no danger of leaving his children beggars.

To the enquiries of such as are desirous of knowing what progress my experiment is making in the disastrous times which former misgovernment has brought upon the country, I wish I could give as satisfactory a reply, in reference to the whole, as I am enabled to do in this individual case. Last winter, many of the collieries stopped working, on account of the failure of those who had adventured therein, and the deplorable state of the neighbouring ironworks has thrown a great number of hands out of employ; so that there are, probably, on an average, two competitors for one place of work, notwithstanding which, the colliers' wages have not been reduced, but their hours of working. Again, other attempts have been made to subject the industrious poor to local taxation, and to the payment of rates for roads they never use, and for a church they never attend. The consequence of all this is, that many who had saved money and acquired homes of their own, have been obliged to mortgage, while others have sold their property, and, in disgust, gone to America with the produce. Nevertheless, a few new houses have been built this summer, and though there are great drawbacks on the progressing prosperity of the three villages, they by no means negative the principle on which the experiment was founded; but, on the contrary, though they may unhappily impede its progress, add fresh proofs of the great truth, that, if relieved from the heavy burdens of taxation, and badness of trade consequent thereon, and if they were fairly dealt with, the industrious classes, now in danger of annihilation, would, in no long time, redeem both their characters and their circumstances; and, instead of being a national burden, and a source of anxiety and terror, would contribute to the strength, and insure the safety and tranquillity, of the country.

I am, Sir, yours, &c.

JOHN H. MOGGRIDGE.

Woodfield, Monmouthshire, Oct. 10. 1832.

ART. V. *A Question to the Author of "The Domestic Gardener's Manual."* By Mr. MAIN.

Sir,

IN your Magazine, Vol. VIII. p. 142., there appears a communication containing some very pertinent remarks, by the talented author of *The Domestic Gardener's Manual*, C.M.H.S., in which he very properly advises vegetable physiologists to be cautious in forming general conclusions from imperfect or partial appearances of either the motions of the fluids, or the uses of the several organs of plants. This is good advice; for it cannot be denied that there are certain points in the science far from being explicit, especially to those who, like myself, cannot dive deeply into the philosophy of it.

In the communication alluded to, there is one of those stumbling-blocks which is believed, and consequently thoroughly understood, by the author as well as Mr. Knight, P.H.S., whom he quotes, and which, if he will condescend to explain, would be, I can assure G. I. T., a very great favour to us practical men. He is a lover of science, and, I presume to think, would be gratified to enlighten those that have not the advantages of either chemical knowledge or extensive reading to assist their studies of vegetable phenomena.

The enigma I allude to is contained in the following sentence:—"The nutriment absorbed becomes the true sap or living blood of the plant by exposure to light in the leaf; that it descends by the bark, by which *the matter that forms the layer of alburnum is deposited.*" The idea of the new layer of alburnum being formed by, or out of, the true sap, is declared again and again in Mr. Knight's writings, and reiterated repeatedly in the *Domestic Gardener's Manual*; but in all cases, I beg leave to say, without sufficient proof. Now, as it is high time that all obscurities should be, as far as possible, cleared away from this interesting subject, and that no gratuitous concessions should be required of the student, I would most respectfully beg leave to propose the following question:—*Is it possible that organic structure can be formed out of mere fluids, whether simple or compound, as they are found in the root, stem, leaves, flowers, or fruit of plants?* If such a process of accretion be possible, I would wish to be informed how it takes place; and particularly, whether there be any similar process or instance, in the whole range of animated nature, with which it can be compared?

As a very superior chemist, and as a natural philosopher, I beg of G. J. T. an answer to the above simple question;

but, as he is also the author of the *Domestic Gardener's Manual*, must, on the behalf of every gardener who reads the book, demand an explicit answer at his earliest convenience. The answers of other writers are inadmissible: we have had already too long a concatenation of these passing current; but of which I am willing to believe the author of the above-named book will disdain to avail himself.

I am, Sir, yours, &c.

Chelsea, Oct. 13. 1832.

J. MAIN.

ART. VI. *On Mr. Hayward's Mode of training Peach Trees, as compared with Mr. Seymour's Mode.* By JOSEPH HAYWARD, Esq.

Sir,

WHEN I wrote my last (p. 483.), I had not seen your description of Mr. Seymour's method of training the peach tree, nor had I any knowledge of what it was. I, however, there stated my belief, that, whatever may be the merit of this mode of training above Forsyth's or the common fan fashion, if the principles and laws of nature are such as I had explained them, such merit must be derived from his having more correctly conformed to those principles and laws of nature. I have since referred to your former Numbers, wherein Mr. Seymour's mode is described [Vol. I. p. 128., Vol. II. p. 295., Vol. VI. p. 436., Vol. VII. p. 242. 248. 687., Vol. VIII. p. 51.], and I find I was not mistaken. The only merit is, that by this mode the leaders which produce the bearing wood are laid on an angle of about 45° , and the bearers are all produced from their upper sides. This is conformable to my explanations, and to my seventh rule, which is, — "In all erect-growing trees, placed in an open situation, and where the light falls equally, the flow of sap is vertical; and the strongest branches will form in this position, until the stem or trunk acquires a certain age or elevation, which is determined by the soil, situation, and nature of the tree; but in places where the light is obstructed on any side, the flow of sap inclines towards the light:" and to the eighth rule, which is, — "If a bud, formed and placed for a leading branch, be removed, or the vessels connected with it be contracted or injured, and the usual passage of the sap obstructed, the wood-bud occupying the next best position will take its supply, and perform its office; and when, from any number of buds formed to receive a quantity of sap, a part of them be taken away, the share of sap which that part would otherwise have received is given

to those remaining, and they are extended proportionally." Agreeably to the seventh rule, by placing his leaders on an angle of about 45° , Mr. Seymour produces an equal division of the sap; and, conformably to the eighth rule, as he allows no buds to produce shoots but those which grow on the upper side, he produces bearers of luxuriant growth: but, inasmuch as Mr. Seymour does not avail himself of the further advantages permitted by the seventh rule, his plan is inferior to mine. For instance, Mr. Seymour's plan is exhibited in *fig. 124.*; and my plan in *fig. 123.*: —

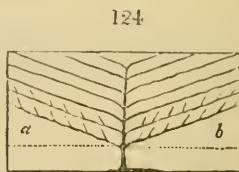
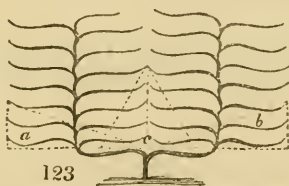

Then, by his plan, there must be two angular spaces left under the first leaders, or tiers of branches, as marked *a* and *b*, that are without fruit: and, as your practical men will most likely say, "Talk as you will of principles: the proof of the pudding is in the spending," let us see what is the difference in the effect of those two methods of training. In the presence of some gentlemen, I have, this morning, drawn a line, parallel with the surface of the earth, as marked by the dotted lines in the sketch (*fig. 123.*), under the lower horizontals of a tree in my garden; and, raising a perpendicular line of 3 ft. from the extreme end, have brought the line down to the centre (*c*); thus forming two angles, as marked by *a* and *b*: the length of the lower base of each triangle is 9 ft.; and the full spread of the tree 18 ft. In each of those angles I have more than one hundred perfect peaches. Again, from the centre of the tree (at *c*), I raise a perpendicular line of 5 ft. (the tree at present producing no fruit above that height): from the upper point of this line I form an angle on each side, to a base of 3 ft., right and left, from the centre, as marked by the dots. In this angle (*c*) there are more than one hundred peaches; and, within an angle formed between two trees, the same as in the centre of one, I have upwards of one hundred peaches: so that every part of the wall is equally covered. On the whole tree, that has been trained for five years only, I have seven hundred peaches; and they were so thinned as that no two peaches touched at the stoning; they are, consequently, of a uniform size: and by the means which I adopt to sustain or feed my trees, each fruit is brought to maturity; not twenty

peaches on a tree are imperfect and vapid. Then, to enable your readers to judge between us, will you ascertain and state the produce of the tree trained after Mr. Seymour's mode in the Chiswick Gardens? I cannot be answerable for Mr. Thomson's success in executing my plan of training with two stems, which he was directed to establish in the Chiswick Gardens; but I am at all times ready to exhibit practical demonstrations of the truth of my conclusions and representations in my garden here. My trees are of five years' training; and having now one fourth more bearing wood than last year, I have no fear of obtaining one fourth more fruit next year.

In your *Encyclopædia of Gardening* you give my sketch of training on one stem thus (*fig. 125.*): but take no other notice

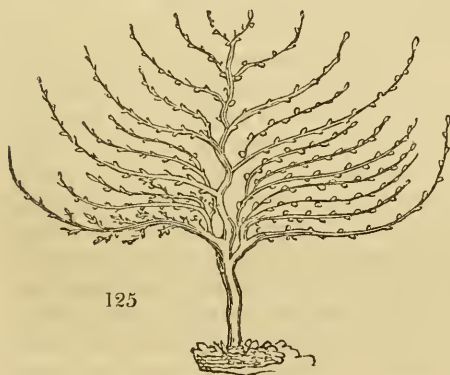

125

of it than calling it the "wavy fan fashion."

As you made no observation whatever on my principles of training, you make it appear that you consider this form as the mere indulgence of fancy — a whim; but by this you discover either your ignorance or your contempt for scientific knowledge: and is this consistent

with your duty as the literary caterer for gardeners? By no other means than by this "wavy fan fashion" can the horizontal leaders be trained to the fullest extent which the tree will cover, in the same time; and, at the same time, fill every part of the space allowed it with bearing wood: for, according to the law stated, that the sap will flow to the most vertical buds, and there form the strongest branches, by turning up the ends of the horizontals, thus, , I make the extreme or point bud present the most vertical channel, and thus obtain from it a strong branch, perhaps, of 3 ft. long; and then, by bringing this down to a precise horizontal, all but 6 in. or 8 in. at the end, I lengthen such horizontal 2 ft. or more; and, thus proceeding, carry it to any length. Then, in what respect is this mode of training inferior to Mr. Seymour's, or any other? supposing one stem to be preferred to two.

I am, Sir, yours, &c.

Radipole, near Weymouth,

JOSEPH HAYWARD.

Sept. 4. 1832.

ART. VII. *On the Application of the Ammoniacal Liquor of Coal Gas to the Destruction of Insects and Vermin.* By ROBERT MALLET, Esq.

Sir,

I HAVE much pleasure in complying with your request (Vol. VII. p. 558.), by furnishing such details concerning this particular use of ammoniacal liquor, as, I imagine, will be sufficient for every intelligent gardener. Ammonia is present in the ammoniacal liquor, partly pure or caustic; but, in a larger quantity, in the states of sulphate and carbonate of ammonia; and I find the following to be one of the best modes of finding exactly the entire quantity of pure ammonia contained in a given quantity of the liquor:—

Place 300 or 400 grains of the liquor in a small retort; apply a gentle heat, and collect whatever pure ammonia is present over mercury, and observe its quantity. Dilute the fluid with an equal weight of distilled water; and carefully drop in either muriate of lime or of barytes, until it ceases to occasion any further precipitate. Then filter and wash the precipitate with pure water, add the washings to the clear liquor, and evaporate the whole to dryness in a previously weighed flask, applying the heat carefully, towards the end of the evaporation, lest the muriate of ammonia be sublimed. Let the flask and contents be again weighed; subtract the former from the latter weight; and the difference will be the weight of the muriate of ammonia produced by the sulphuric and carbonic acids, which formed the sulphate and carbonate of ammonia, quitting their base and uniting with that of the muriate of barytes or lime, and the muriatic acid of the latter uniting with the ammonia of the former salts. The weight of muriate of ammonia being known, the quantity of pure ammonia may be easily estimated, every 100 parts of the former containing 31·95 of the latter.

I give this at length, to enable any gardener, who is competent (and what gardener can pretend to understand his business who is not a tolerable chemist?), to repeat the process; which it will be well to do before using the liquor, as that obtained from different gas-works contains varying quantities of ammonia.

Those, however, who are unable to determine the quantity of ammonia for themselves, may rely safely enough on the result of my experiments; viz., 1 ft. of ammoniacal gas will be produced from 11023 grains of ammoniacal liquor, at a mean temperature and pressure of the atmosphere. There is no gardener, I should hope, at the present day, who cannot find the

cubical contents of a horticultural house; so that the quantity of liquor necessary to fill one fifth or any other portion of the contents of a house, at a mean temperature and pressure, is thus easily known. But all houses are not at a mean temperature; viz., 60° Fahr.: it may, therefore, be necessary to make a correction in the volume of gas for temperature. The following rule may, therefore, be used to estimate what would be the volume of any portion of gas, if brought to the temperature of 60° Fahr.: — Divide the whole quantity of gas by 480: the quotient will show the amount of its expansion or contraction for each degree of Fahrenheit's thermometer. Multiply this by the number of degrees which the gas exceeds or falls below 60°. If the temperature of the gas be above 60°, subtract the product from, or if below 60°, add it to, the absolute quantity of gas: and the remainder in the first case, or sum in the second, will be the answer.

As perfect accuracy in determining the quantity of gas is not necessary, there never can be need of any correction for pressure.

All this may possibly, to some, appear to have more of craft than utility in it: to which I say, first, if a thing is worth doing at all, it is worth doing rightly; and, next, if it serves no other purpose, it will be a good exercise of thought, &c., to young gardeners. Now, as to the mode of producing and applying the gas. Those who can, ought to have a vessel proper for the purpose, made of tin, a section of which is here represented. (*fig. 126.*)

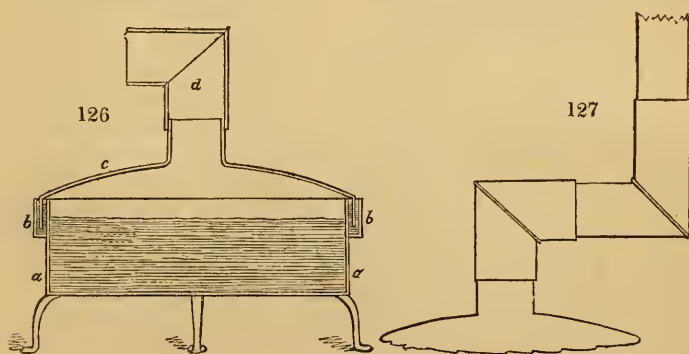

In this figure, *a* is a cylindrical vessel of tin, about 15 in. in diameter, and 6 in. deep; *b* is a channel, formed by an external concentric cylinder of tin, about 2 in. deep, and half an

inch from the internal one. This is filled with water; and when the lid (*c*) is put on, its edge goes down into the water, and forms an air-tight joint or valve. The gas passes off by the tube (*d*), likewise made of tin, which should have two bends at right angles (*fig. 127.*), in separate pieces, to permit its motion in all directions.

Into this vessel the previously determined quantity of ammoniacal liquor is to be put; and about half a pound of quicklime, in small pieces, for every quart of liquor, is to be added. The cover is then put on, and the tube inserted into some convenient opening in the lower part of the house, taking care that no plants are very close to the aperture.

In this way, which I find a great improvement upon the plan of evaporating the fluid, the gas is abundantly disengaged; the slacking of the lime produces sufficient heat, without the application of fuel; and the ammonia is in a caustic state.

Those who cannot procure this apparatus will probably not be able to get the liquor either; but should they get the liquor, a small still, or even a watering-pot, placed within the house in this position (*fig. 128.*), may be substituted.



Ammoniacal liquor may be used with safety for washing dirty pines, and the wood and buds of vines; to kill the red spider early in their season of appearing. Plants in pots, when very dirty, may even be dipped into

it, diluted with an equal quantity of water; and soon after dipped into, or syringed with, pure water, to wash it and the dead insects off. A single very filthy plant, with close hard leaves, such as a *Pandanus*, a *Bonapártea*, &c., may be covered with an inverted barrel, and the gas applied to it alone, the plant being previously and subsequently syringed.

In every kind of house, it is well to syringe gently before applying the gas, as the water absorbs some of the gas, and it thus acts more powerfully; but, in every case, the house should be syringed afterwards.

In very humid houses, rather more of the gas than one fifth of the volume should be applied; the quantity, however, will in general be best found by the observation of the intelligent

gardener. Diluted ammoniacal liquor, where it can be procured abundantly and at a reasonable rate, is a powerful and excellent manure; and, like salt, possesses the valuable property of clearing the ground from all insects and worms.

I am, Sir, yours, &c.

94. *Capel Street, Dublin, Nov. 7. 1831.* ROBERT MALLET.

ART. VIII. *Design for a Gardener's House, adapted for being connected with the West Wall of a Kitchen-Garden.*

In pursuance of our plan of giving eight designs for gardeners' houses, especially calculated for the four sides and four corners of kitchen-garden walls, we present *figs. 129. and 130.,*

129

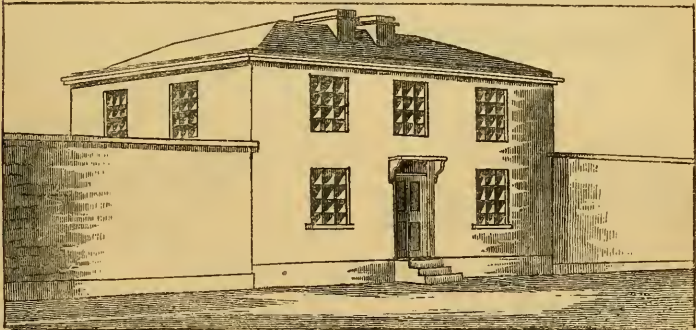

before we describe which, we shall introduce a few remarks, which have been sent us on the subject by our architectural friend who first suggested the idea of publishing them. "The gardeners' houses which I visited in Scotland are either lean-tos generally behind the hot-houses, and consequently exposed to the north winds, and precluded from all sunshine, except during a few weeks in summer; or they are detached houses, generally lodges to gates, or placed in conspicuous situations in the grounds as ornamental objects. Now, the first class I consider as discreditable in point of humanity, and the other equally so in point of architecture. Would any human being voluntarily submit to live on the ground, under a shed exposed to the north, and excluded from every ray of light or sun from the south? Surely, no master entitled to the appellation of humane would wish a servant to remain in such a dwelling, if the evils attendant on it were pointed out to him. I have been particularly requested not to mention

130

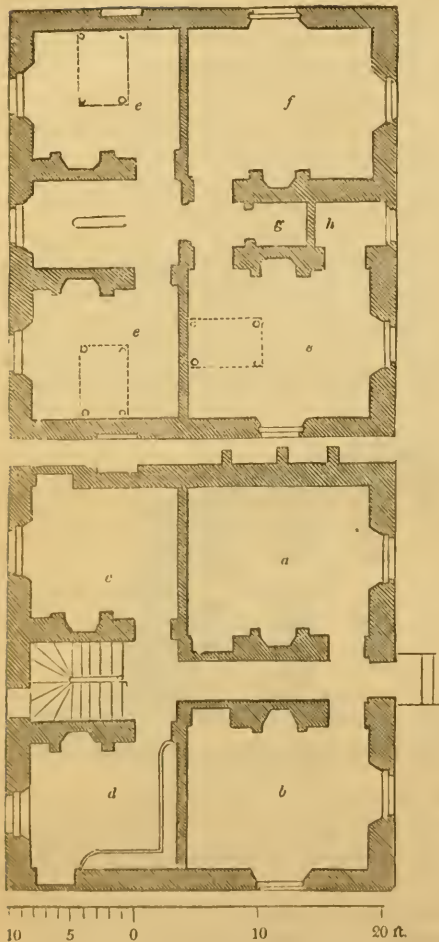

names where the gardeners live in sheds, and therefore I shall not do so; but I am not under the same restraint with respect to the ornamental lodges, and therefore I shall just refer to one, all show on the exterior, without either accommodation or convenient arrangement within, as a specimen of the discredit in architecture; it is the gardener's house at Eglinton Castle, and I mention it the more readily, because I have no idea who was the architect."

The design before us contains, on the ground floor, a kitchen, *a*; parlour, *b*; back kitchen, *c*; and office, *d*. The chamber floor contains three good bed-rooms, *e*; and a seed-room, *f*. There are two closets, *g* and *h*.

ART. IX. *Design for a Gardener's House, serving, at the same time, as a Watchtower for the Fruit Walls of a Garden in the Neighbourhood of a large City.* By T. A.

THE following design, by one of our most eminent London architects, was sent us for our *Encyclopedia of Cottage, Farm, and Villa Architecture*, as the gardener's house of an elegant suburban villa, the plan of which accompanied it. Both are such perfect models of their kind, and display so much in so little, and at such moderate cost, that we cannot resist the

temptation of giving the gardener's house in this Magazine, though it will appear also, with the villa, in our Encyclopædia. Both the villa and the house have been erected by the architect for himself; and, as we have had the pleasure of frequently seeing both for several past years, we can answer for their being as satisfactory in execution, and as convenient in use, as they are admirable in design.

Fig. 131. is the ground plan of the gardener's house; in

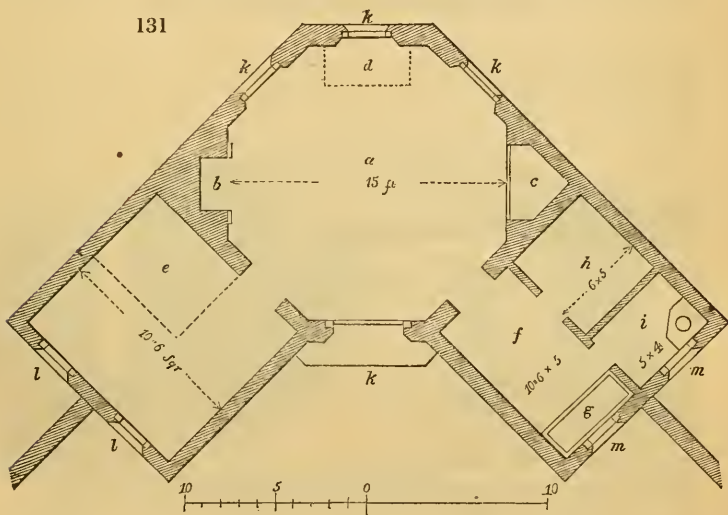

which *a* is the living-room, an octagon 15 ft. in diameter, with a fireplace *b*, and large closet or pantry, *c*. There is a trapdoor in the floor at *d*, to a store-cellar below; and in the centre of the ceiling there is another trapdoor to a seed-loft and herb-room in the roof. The step-ladder, by which the loft is entered, stands under the trapdoor to the cellar, serving as a stair to it, so that it is always at hand to be used for going into the loft. It will be observed that this room commands the diagonal of the space within the garden, and an entire square of space without it, as indicated by the letters *kk*. The bed-room, *e*, commands by its two windows the south and north sides of the wall, which lies east and west (or what is commonly called by gardeners the south wall, from its aspect), as indicated by the letters *ll*. There are, a scullery, *f*, with a sink, *g*; a coal-house, *h*; and watercloset, *i*. From the two windows of *g* and *i*, the east and west sides of the eastern boundary of a square garden are commanded by the gardener, as indicated by the letters *mm*. The gardener, or his wife, seated in the centre of the living-room, with the bed-room and scul-

lery doors open, will command from that position the whole of the interior of the garden.

If it were desired to add to the accommodation of this dwelling, it might easily be done by a staircase taken from the living-room, descending to a floor below, containing the apartments *f, g, h, i*, and a kitchen; and ascending to a floor above, of either one octagon room in the centre, or three rooms.

Fig. 132. is a perspective view of this house, as seen placed

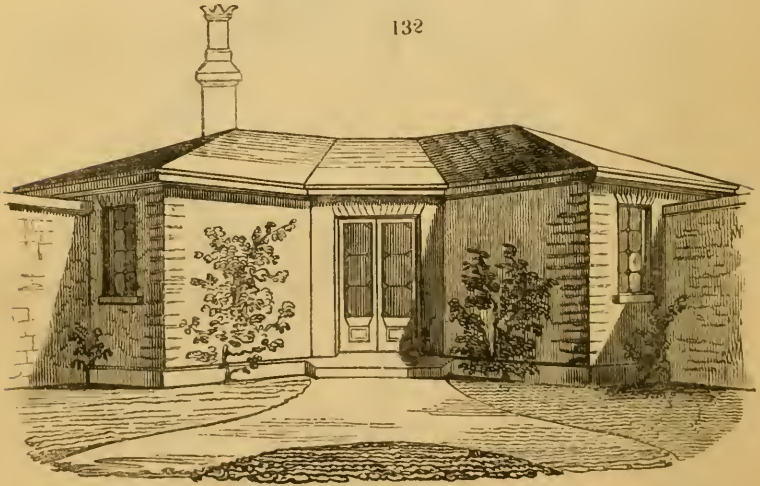

in the north-east corner of a walled garden. To the right and left are seen portions of the south and west walls, and in the centre is the entrance door.

ART. X. *Designs and Details for opening the Gates of Lodges to Gentlemen's Seats in the Night-time, without troubling the Gate-keeper to leave his Bed.* By Mr. SAUL.

Sir,

WHEN you were in this neighbourhood, you directed my attention to the opening and shutting of the turnpike gates; and I have since found, by inspection, that those near Lancaster are very imperfect. The following plan I consider more complete than any thing I have yet met with:—

Fig. 133. is a design for a lodge gate, the centre part of which may be opened and shut with the greatest ease, by any one within the lodge, by turning the handle marked *a*, in *figs.* 134. and 135. Ten turns of this handle will open the gate, and

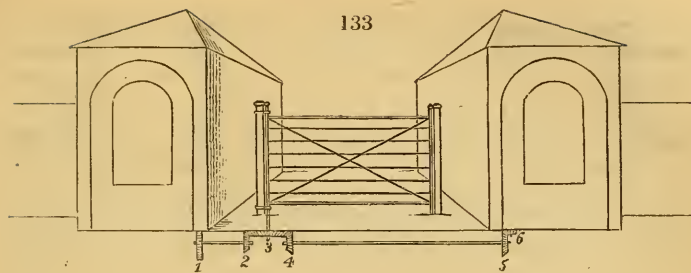

it takes the same number to shut it. If it should be considered desirable to have the gate opened from an upper room, it may be done by means of the handle *b* in *fig. 135.*, which will require twenty-four turns to open or shut the gate.

Fig. 134. shows how the wheel No. 1. is connected with the

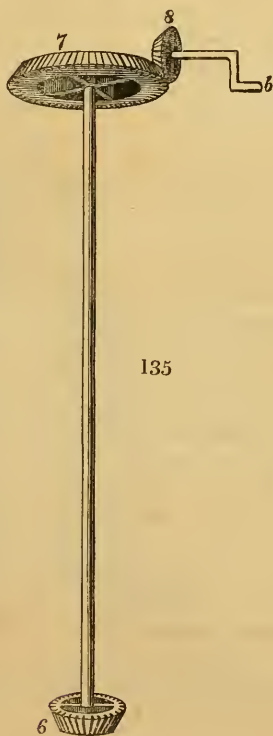

handle *a*: the wheel *c* is merely introduced for the purpose of raising that handle, which should be about three feet from the floor, as in the plan, *fig. 136.* In the same figure, the wheels are seen fixed to the wall at *e.* *Fig. 135.* shows the manner in which the wheel No. 6. is connected with the handle *b.* I do not consider it necessary to place machinery for opening gates to be operated on from sitting-rooms, but only from bed-rooms.

The size of the wheels is as follows: — No. 1. is four feet in diameter; No. 2. is twelve inches; No. 3. three feet; No. 4.

twelve inches; No. 5. three feet; No. 6. nine inches; No. 7. three feet; and No. 8. six inches.



Fig. 137. is another plan for opening and shutting the gate by means of two drums or cylinders: *i* is the cylinder to which the

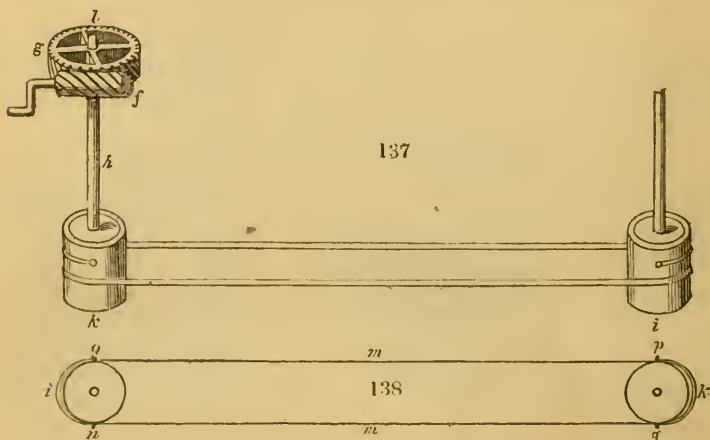

gate is fixed, and supplies the place of the wheel No. 3. in *fig.* 133.; *k* is supposed to be in the place of No. 6.; and *l* in that of Nos. 7. and 8. The wheel *g* is about eighteen inches in diameter; *f* is the worm pinion to turn *g*, and is about six inches in diameter. This plan will be equally efficacious for an upper or a lower room, as it makes no difference what the length of *h* is. *Fig.* 138. shows that two chains, *m m*, are fixed to the cylinders *i k*, at *n o* and at *p q*. This plan I consider as cheaper and simpler than the other. I am, Sir, yours, &c.

M. SAUL.

Sulyard Street, Lancaster, Dec. 22. 1831.

ART. XI. *A Description of Two Kinds of Beehive.*
By Mr. W. YOUNG.

Sir,

I HAVE constructed two sorts of beehives, which, I think, are worth being noticed in your Magazine. One (*fig.* 139.) is shaped like the but of an ancient elm, and is placed on a block

of timber in the ground. It has a rural appearance, and is very useful in affording fresh honey occasionally, without injuring the bees. A door opens in the rear, and inside is a glass door, which you can open to take out as many of the combs as you wish. The bees do not swarm, nor are they any trouble after being once put into the hive, which is done in the same way as with any other hive, by scenting the inside. The ends are two round boards; and rails of wood are nailed to these, and strong canvass nailed round, leaving only the door. Two slight iron hoops are nailed over the canvass, in order to strengthen the rails, one going round at the top of the door, and the other at the bottom, so that the door is between the hoops. Another piece of canvass is then put over the first, and nailed all round as before, which makes the frame quite firm and strong. Now brush the canvass all over with thin paste made of flour and water, in order to fill the canvass and make it stiff, to keep the paint from going through the first canvass next the honey; and, when dry, give two coats of white paint. When the paint is dry, lay the whole surface

139

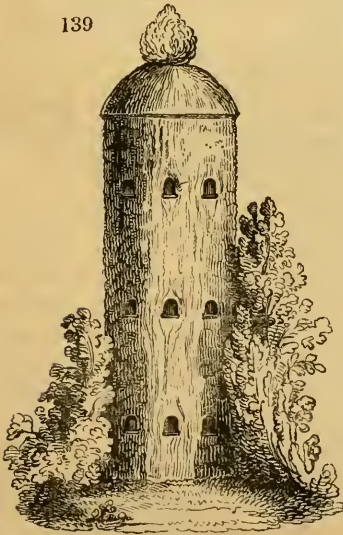

over with strong putty in imitation of the bark of the elm, ash, or any tree, to your fancy. When dry, paint it as like the colour as you can, and stick pieces of moss and lichen in the putty from the trees. There may be some fixture on the top, to throw off the rain. This one has a large cone of the stone pine, for the bees to light upon.

The sticks are fixed cross-wise, proceeding from the three entrance holes to each side of the door in the rear. Currant bushes are growing up the two sides, and a few plants of thyme in front.

The bee-holes in the bark look like keyholes, and they, being the same as in a door, and painted like bark, are not noticed; they have brass outside shuts in cold weather.

Construction of a Beehive from which the Honey may be taken without destroying the Bees.—Make a square hive of straw; when at the height of 5 in. work a floor of the same all over, leaving three round holes in the middle, about half

an inch wide, in this way, . . . Get a beehive, and fix a few thin willow sticks up the sides and top inside. Line the inside with canvass fixed to the sticks, and fastened outside the hive. Fix a thin board in the mouth of the hive, making it fit quite close and tight. Then make three holes in the middle, the same as before noticed, which lay over the holes in the division or floor. Then continue making the outside hive until high enough to permit the passage of the other; and leave a door to open, to take it out and put another in. Three sticks are to be placed from the bottom to the holes in the floor, for the bees to creep up into the upper hive, where it is likely they will first begin. When the upper hive is full of honey, take it out and put in another, leaving always what honey is in the under one for their support. When you wish to take the honey, set the hive on a dish, cut the fastening of the canvass and sticks, and shake the hive until the combs slip out on the dish; then remove the canvass, and the honey will be clean and the combs whole. If any bees remain in the combs, brush them off with a feather, and they will fly back into the hive again.

I am, Sir, yours, &c.

Florence Court, April, 1832.

W. YOUNG.

ART. XII. *Notice of a new Transplanting Instrument for Florist's Flowers, invented by Captain Hurdis, R. N. Communicated by Mr. CAMERON, Nurseryman at Uckfield, Sussex.*

Sir,

THE new instrument I left with you was invented by Capt. G. H. Hurdis, Royal Navy, residing in Uckfield, Sussex; and it is made, according to his directions, by Mr. Noves, ironmonger, Uckfield. Its use is for removing plants, bulbs, &c., at any season, and to any distance, with safety; or into pots, with the greatest facility. As you seemed to approve of the instrument, you will please to give it such a name as is appropriate to it, and say of it what you think it deserves. As Captain Hurdis is a very ingenious gentleman, and takes much interest in gardening, I have no doubt that you will have something else from him; as he is frequently contriving different sorts of tools for the use of his garden and the public in general.

I am, Sir, yours, &c.

Uckfield, Oct. 17. 1832.

JAMES CAMERON.

THIS instrument consists of three parts, a cylinder about 6 in. long, and $5\frac{1}{2}$ in. wide, open at top and bottom, and with two handles. (*fig. 140. a.*) The edge is serrated, with four saw teeth at bottom, which teeth, with the rest of the edge, are sharpened by a file. There is a bottom into which

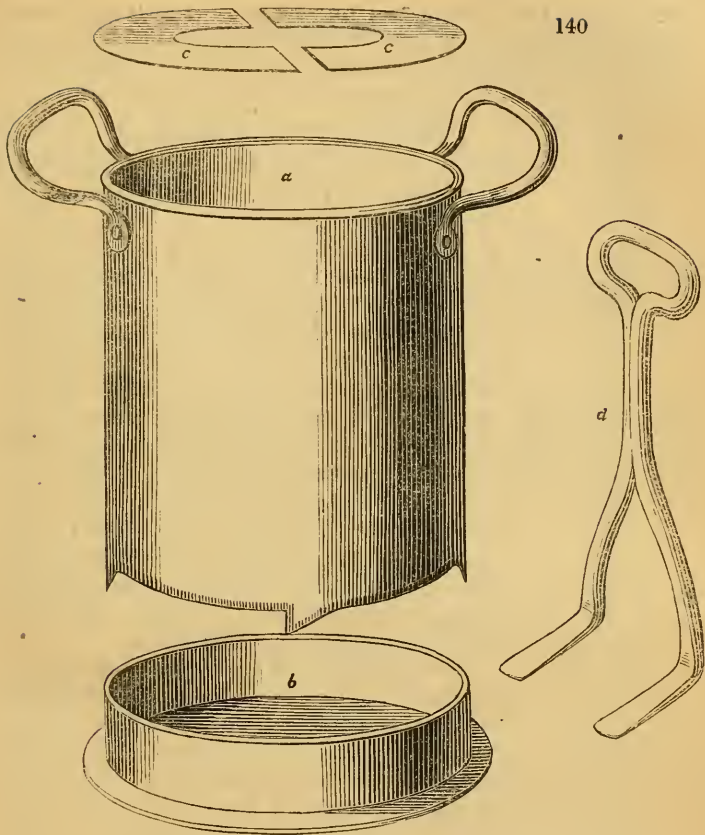

this fits, *b*; two segments, *c*; and a pronged instrument, *d*. Supposing it desired to remove a hyacinth, the cylinder is placed over the plant, and worked into the soil till it is filled to the brim. The cylinder and soil are now lifted up and placed on the bottom (*b*), which fits sufficiently tight to adhere without any fastening.

The two flat semicircular pieces (*c*) are then placed on the surface of the soil, on each side of the stem of the plant. It may now be watered, and kept in the instrument as in a common flower-pot; or carried to any distance, and the bottom (*b*) being taken off, the plant and ball of earth may be pushed through the cylinder (*a*) into a pot, or a hole in the soil, as may be desired, by pressing on the semicircular plates (*c*) with the pronged instrument (*d*). The same arrangement is particularly favourable for packing and sending to any distance.

[This is certainly a simple, ingenious, and very effective invention of the kind; and, as Mr. Cameron has asked us to give it a name, we propose calling it *Hurdis's Flower-Transplanter*. We shall be happy to receive accounts of Captain Hurdis's other inventions, and also of a certain tool for stirring ground encumbered with roots or stones, preparatory to planting, mentioned by Mr. Cameron, and of which he has seen no account published. — *Cond.*]

ART. XIII. *Description of an Instrument for Use in the Summer Pruning of Forest Trees.* By MR. WILLIAM TAYLOR, Gardener, Thainston, Aberdeenshire.



Sir,

I HERE send you a sketch of a pair of pruning-shears which I have invented for checking rival leaders of forest trees. The blades of the shears are 5 in. long: one has a socket for a handle 10 ft. long; the other has a tail about 10 in. or 12 in. long (to give it lever power) with a hole in the end, to which a piece of garden line is fastened: the line passes over a pulley of 2 in. diameter, and is kept to the shaft by small staples: the spring is for keeping the shears open, and the pin in the socket is a stopper to prevent the blades overlapping each other. The end of the handle rests in a short strong leather socket from a belt round the waist, which gives the workman the use of his left hand to guide the tool, and of his right to work the cord with. It will cut a branch fully one fourth of an inch thick.

I use this tool for checking rival leading shoots of young forest trees, principally in their growing state, in June and July. Many trees have three or four leaders, and it often happens that the main leader is overtopped by a side branch. I have been often vexed because I could not reach such leaders; they being from 7 ft. to 14 ft. high, the tree too slender to support a ladder, and the shoots too small for a pruning-chisel: but with these shears a man will do it in a moment; and they could, by means of a longer handle, be made to reach to the top of a tree 16 ft. or 20 ft. high. Lateral shoots may be fore-shortened back to the first or second twig. Here, I hope, it will not be understood that I recommend clipping trees to a uniform shape. No: trees can be properly trained, and yet their natural forms in a great measure preserved.

This tool will be found useful in trimming climbing and trailing plants against a wall, when they are beyond the reach of persons on the ground, or upon a too short ladder.

It is best to use it on a calm day. I would not apply it in pruning fruit trees, notwithstanding shears have been recommended for summer-pruning gooseberry and currant bushes, by no mean authority. I am, Sir, yours, &c.

Thainston, Aberdeenshire, July, 1831.

WM. TAYLOR.

ART. XIV. *A Description of a useful Garden Implement termed Parallel Rods, designed for marking Parallel Lines on Beds.* By its Inventor, Mr. WILLIAM GODSALL.

Sir,

I HAVE had made what I consider a useful instrument to facilitate the planting of ranunculuses and tulips, and for various other similar purposes. I call it "parallel rods:" it is made of deal, and costs me about three shillings. *a* and *b*

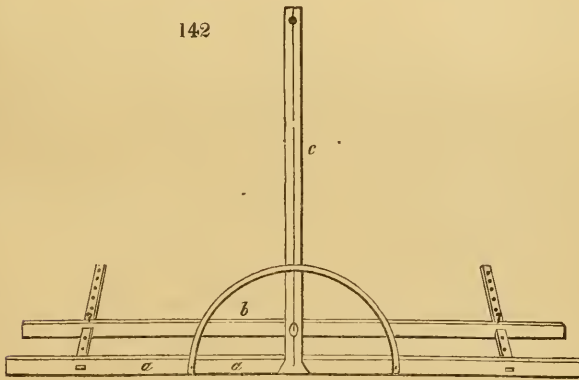

(*fig.* 142.) are two rods, 6 ft. long and 2 in. wide. Into *a*, two strips, 14 in. long, are firmly mortised, at right angles, these pass through *b*; and by means of wooden pins the rods are secured at the required distance apart. *c* is the handle, fixed to *a*, at a right angle.

When the bed is raked level, and edged, I leave the necessary margin along the side, and place the rod *a* where the outside row is to be planted, then slightly press the rods with the foot, which leaves two parallel impressions. I then shift the rods on in a direct line, placing the ends of the rods as a guide, a foot or so along the first marks, and then press them as before; thus repeating it, to the end of the bed; and, in returning, I place the rod *a* in the mark made by *b*, till I have

thus marked the whole bed longitudinally. I then, by applying my parallel rods in a similar manner across the beds, intersect these longitudinal lines; and at each intersection I place my root or plant. By this method a bed 20 ft. by 4 ft. may be accurately marked out in five minutes. The instrument is useful as a square; and also as a level, by attaching a plummet line to the top of the handle; and the rod *b* is divided into feet and inches, and is easily detached for sundry purposes.

I am, Sir, your's, &c.

WM. GODSALL.

Hereford, Sept. 29. 1832.

ART. XV. *A Plan and Description of the Flued Walls in the Gardens of Erskine House, with a Plan and Description of the Kitchen-Garden there.* By Mr. G. SHIELLS.

Sir,

AGREEABLY to your request when here, I now send you a sketch of our kitchen-garden (*fig.* 144.) and flued walls (*fig.* 143.), with some description of them.

Our mode of heating these walls is simple but effectual. As will be seen in *fig.* 143., there is an open space, with a damper fixed immediately over, where the smoke and heated air enter the wall from the furnace at *a*: this damper regulates the heat through the whole wall. I found that when the damper was drawn about 4 in., a sufficient portion of the smoke and heated air passed through the two under flues to produce the necessary degree of heat in these flues; and, after passing through these, being again united to that part ascending through the opening left at *a*, the whole body of smoke then ascends, and passes through the third and upper flues, by which these are heated a little more than the lower ones. This I consider a great advantage, because the upper part of the wall is more exposed to the cold air, and less benefited by the reflection of heat from the ground; besides, the shoots there are generally more luxuriant and spongy, and consequently later in ripening.

No trellis is required for this wall; for, if the damper be properly fixed, there is no danger of overheating any part of it; the only part where danger from overheating is to be apprehended is where the heat enters from the furnace, which is 18 in. from the wall, and 2 ft. below the surface of the ground. To prevent the roots of the trees on the south side of the wall from being injured by the heat, 4-inch brickwork

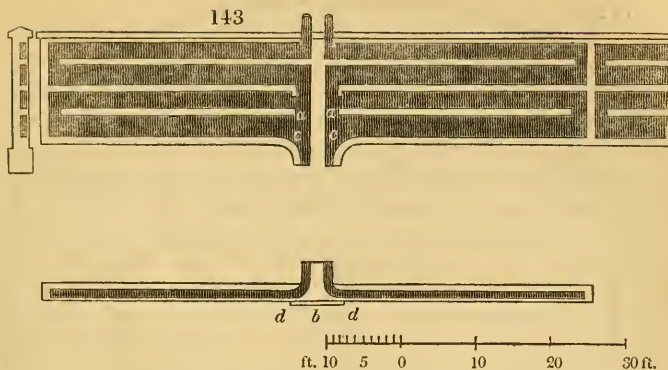

is carried up, opposite the furnace, to within a few inches of the surface, with a 2-inch cavity (*b*). As the heat rises above the surface, it enters the wide space (*c*); from whence it is immediately divided through the wall. I have, however, a yard or two of the wall, at the warm end of the under flues, a little thicker (*d*).

As flued walls are always warmest towards the top of the flues, the idea struck me, that if one, two, or more bricks (according to the depth of the flues) were built across the upper ends, as shown at *e*, they would, by confining the draught of smoke towards the bottom of the flues, tend to equalise the heat in them. This did not answer my expectations; for it retained too much of the heat in the under and third flues, which caused a deficiency in the second and upper one: but having bricks run across the upper part of the cooler ends of the second and upper flues, as shown in the sketch (*e e*), is of considerable advantage, as a means of retaining the heat in these flues; and making the heat throughout more equal and uniform, and requiring less fire: indeed, walls upon this construction never require large fires.

If it were desirable to warm the upper part of the wall only, by withdrawing the damper, and applying a small fire, this would be accomplished without warming the lower part of the wall. Depth of flues, 2 ft. 6 in., 2 ft., 2 ft. 3 in., and 1 ft. 6 in.; width, $7\frac{1}{2}$ in. Bottom of lowest under flue, 1 ft. from the surface; top of upper flue, within 7 in. of the coping; the thickness of the wall, about 1 ft. 9 in.

By reducing the open space in the flued wall (*a*) to about 30 square inches, the damper may be dispensed with; but, by retaining it, the heat can be regulated according to circumstances.

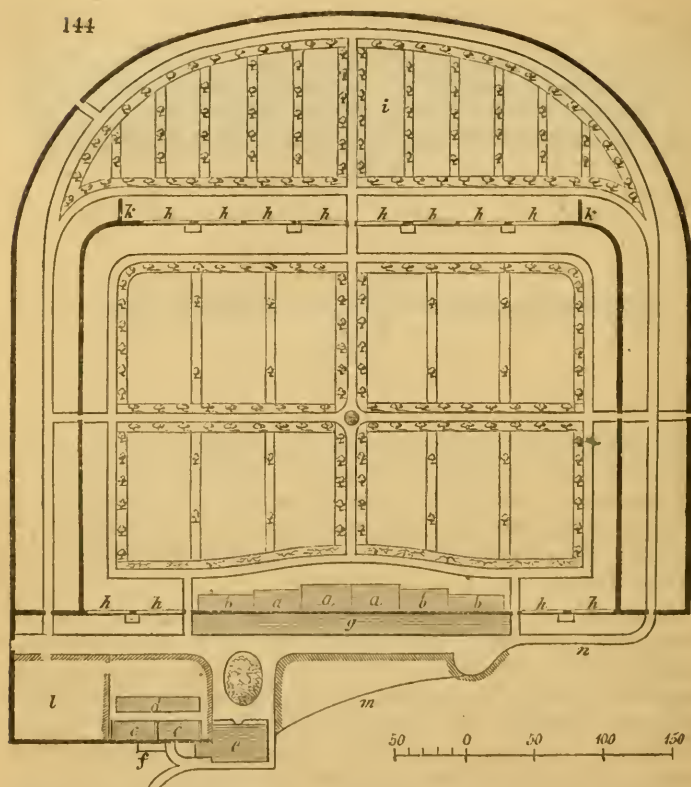

- a*, Vineries. *b*, Peach houses. *c*, Pine pits, not yet erected. *d*, Melon pits.
e, Gardener's house. *f*, Offices. *g*, Sheds. *h*, Hot walls. *i*, Orchard.
k, Screen walls. *l*, Rubbish corner. *m*, Old quarry. *n*, Steep bank.

Kitchen-Garden.—The north wall is 17 ft. high, the inner wall 14½ ft.; and the outer wall 8 ft. on east and west sides, and 4 ft. on south side of orchard, with sunk fence in front. The walk opposite this, being a sort of terrace walk, commands a fine view of a part of the pleasure grounds. The soil is a brown loam, about 2 ft. 3 in. deep, over a bottom of whin rock. The trees upon the borders by the walks are dwarf standards on paradise stocks, except that in front of the hot-houses there is an espalier railing of pears. There are twelve divisions of flued wall; four planted with peach and nectarine trees, three with the finer pears, two with apricots, one with cherries, one with figs, and one with vines. I am, Sir, yours, &c.

G. SHIELLS.

Erskine House Gardens, Renfrewshire,
 Jan. 12. 1832.

ART. XVI. *Remarks on the Question, Whether the Architect or Landscape-Gardener should be first employed in the Formation of a Residence.* By Mr. JAMES MAIN, A.L.S. &C.

Sir,

YOU are well aware that it has long been a question whether the architect or the ground-improver should be *first* employed in laying out a new, or improving an old, country-seat. The late Humphry Repton, and John Nash, Esqrs., were, thirty years ago, at the head of their respective professions, the former as a landscape-gardener, the latter as an architect; both equally eminent for refined taste and first-rate abilities. These gentlemen were friends and co-laborers, being generally employed together wherever their talents were required. But this connection, founded on esteem and mutual interest, was suddenly dissolved, only, as was then publicly understood, by the circumstance of their holding contrary opinions on the question above stated.

Such an occurrence was no way interesting to the public; except, perhaps, calling forth some little feeling of regret at seeing two gentlemen of education, and of most courteous manners, differ on a point on which, from their previous acquirements and studies, they might be presumed to have held similar opinions. It showed, however, that such professors should either know somewhat of each other's principles, or that there should be such harmony as would induce them to *compare notes* of each other's designs.

Whether the question be even now settled is doubtful; because, as many consider the mansion to be the principal object on an estate, they also imagine that all accompaniments are subordinate; and, of course, think that, as the architect is accountable for the style, stability, comfort, and conveniences of the dwelling, he should also have the privilege of exercising his judgment (if this point be referred to him) as to where and how it should stand.

But as the style of all buildings is determined by the climate, or by the character of the face of the country around, and as all the landscape-gardener's operations must be *in unison*, it appears, in such a case, that the builder should follow, not lead; and, for this reason, that it is much easier to build a house to suit the scenery of an estate, than to mould the natural features of the latter to those of the former.

No architect of taste would recommend a richly ornamented Grecian house to be built amidst bold picturesque scenery; nor would he advise a Gothic or castellated mansion to be raised upon a beautifully undulated surface. This is sup-

posing him to be acquainted with landscape-gardening; but, if he be ignorant on this head, who would trust him *alone* in such an affair? The architect only concerns himself with the site and aspect of the house, with, perhaps, an acre of ground round it; while his co-laborator has to take an extensive view not only of the details of the estate, but of every interesting object of the surrounding country, whether near or far off. The woods, roads, and rides; the extent and boundaries of the park; in short, all internal dispositions, he must design with reference to some natural and commanding spot, which, in all likelihood, will be found to be the most eligible for the house. Hence it appears that, when the site or aspect of the house is not positively fixed by some local immovable circumstance, the landscape-gardener should be first consulted.

I have been led into these desultory remarks by having often seen glaring instances of want of concert and cooperation between the architect and ground-workman; on which their abilities or taste (if they had any) were completely neutralised, merely from omitting to take a comprehensive view of the circumstances affecting the purpose they had in hand; or, perhaps, from inattention to those particular dispositions which constitute the convenience, comfort, and pleasure of a country residence. That such blunders cannot always be laid at the door of the professional man must be admitted. Proprietors have generally designs and a taste of their own; and oftener give orders than ask advice. In such cases, their workmen are "more sinned against than sinning;" and all the satisfaction the latter can have in the execution of what they condemn, is only in receiving their fee, and denying having had any hand in the work. Still, it is a pity that proprietors do not avail themselves of good advice. Their own ideas are often cramped by old arrangements; such, for instance, as existed in their fathers' time. Being accustomed to things as they are or have been, and with which they have felt satisfied, they are, therefore, never led to consider the possibility of these being made better. Often has it happened that an old stable or laundry, standing in the wrong place, has caused the derangement of a magnificent house, erected at the cost of many thousand pounds, and in a well-wooded park, of finely varied surface, many of the most interesting glades of which are shut out of view from the principal windows, by the interposing offices attached to the wrong side of the mansion. In such cases, it is not only that the best views are lost to the best apartments, the quiet and seclusion of the latter are obtruded on as well by the butcher's and every other cart, as by "the coach and six." Want of a desirable aspect may

sometimes be urged as an excuse for misplacing a house and offices; but this will be no difficulty with a clever architect who has to arrange the suite of apartments.

Besides these, there are many other inconveniences and improprieties of disposition occasioned by the mal-arrangement of the architect; where, had a landscape-gardener been first consulted, his advice, though it might not have prevented, would at least have given timely notice of, the erroneous design.

The following is a sketch of a place where the general plan has been marred by the architect's ignorance of the principles of landscape, and of the value of fine views to, and proper disposition of the accompaniments of, the house he was employed to build. Should it be worth a place in your Magazine, it may convey a useful lesson, not only to proprietors and architects, but also to some of those employed in the improvement of country-seats.

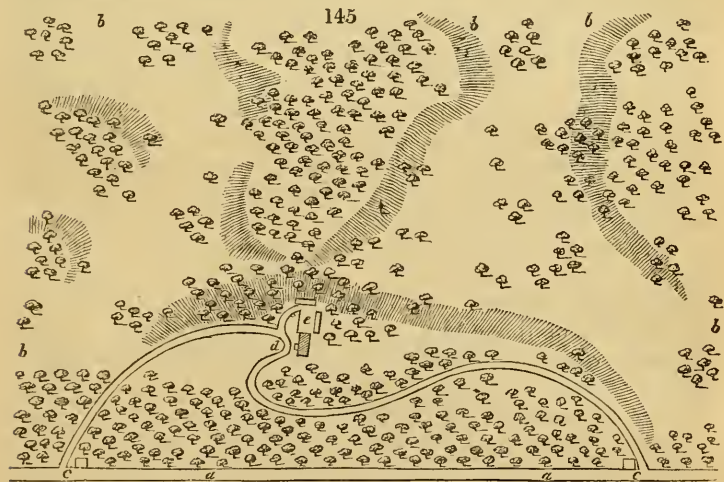

a a, Turnpike road. *b b b b b*, Fine and extensive views of the park and surrounding country.
c c, Entrance gates. *d*, Entrance hall door. *e*, Lower court of offices.

A single glance at this sketch will show the error that has been committed in placing the offices at the wrong end of the house, and losing a fine opportunity of making the finest disposition imaginable. The situation of the house being on an elevated semicircular promontory of the park, commanding the most extensive views in three directions, might have been, together with the dressed ground on each side, offices, and entrance-lodges, all embraced by, and separated from, the pasturage of the park by a ha-ha or other fence. Such a

disposition would have allowed many advantages of convenience, economy, and propriety, which need not be mentioned, as they will readily occur to every one in the least acquainted with the arrangements of a gentleman's residence.

Before ending my letter, I beg to advert to an idea which is rather prevalent respecting landscape-gardeners, and which operates to their disadvantage. It is supposed, as the title of their profession is rather new, and sounds as if closely allied to what is called *fine art*, that their business consists only in forming pretty pictures to delight the eyes of future generations; by the demolition of *old* trees, for the purpose of planting *young* ones a few yards distant; by laying out pleasure-ground in beautifully meandering walks; fanciful flower-plots, and other kinds of embellishment. Now, there are many proprietors who prefer the *useful* to the *sweet* of their possessions, undervalue mere ornament, and, consequently, dread the visit of a man of taste, lest he should rob the sheep of their pastures, the cattle of their hay, or the pigs of their mast and acorns; or lest his merely beautiful dispositions should entail an annual and unnecessary expense to keep the pretty things in order. But such notions are groundless; because, if the landscape-gardener knows not any thing besides the arrangement of flower-borders, the dispositions of the trees in the park, or the erection of alcoves and eye-traps, he does not deserve the title he assumes; because these things are only part of his profession.

The fact is, the basis of landscape-gardening is territorial improvement. The designer must take into consideration the value of the land, and make himself acquainted with the capabilities of the estate; he must see how it can be best divided, what parts should be arable, what planted, and what parts should be appropriated to meadows and pasturage. The two latter, of course, will be near the house; the former at some distance. In all this he looks only at the intrinsic value and most profitable occupation and destination of the various parts. No incongruous intermixture of these parts must appear; and no inconvenience occur in passing from one to another, either by cattle or carriages; he must be prepared to advise what kinds of live stock, and number of each, may be kept and bred on the land, and what portion of this will be requisite for his employer's establishment. In all this he acts in the character of a land steward. In the general arrangement, however, he has to exercise his taste; and here he acts in his profession of landscape-gardener, by forming the most pleasing combinations of the materials he may choose to arrange, with the circumstances which must guide his dis-

positions, whether of ground, wood, or water. Perhaps he may encroach on a fine meadow for the kitchen-garden and orchard; but would this be called waste? or if he take a few acres for pleasure-ground around the mansion, would this be deemed a deterioration of the estate? Are not all estates enhanced in value in proportion as even the trees upon them are or are not ornamentally disposed? If new plantations are to be made, or old natural woods thinned, why should not these works be done tastefully as well as at random? It should be remembered that the pleasing distribution of trees on an estate, in almost all cases, constitutes its principal value. It is in such performances that the assistance of a landscape-gardener is necessary. The application of his taste can never detract from the value of the place; for, in fact, every device he may practise, or every alteration he may recommend, can only be justified by fitness of purpose, use, or beauty; or for convenience or propriety; and always with a view to present pleasure and profit, connected with ultimate and progressive improvement.

I am, Sir, yours, &c.

Chelsea, Oct. 6. 1832.

JAMES MAIN.

ART. XVII. *A Fence for Plantations about Pasture Grounds in sight from a Residence, and Stakes for Standard Roses.* By CHARLES LAWRENCE, Esq.

Sir,

I RECEIVED much pleasure and instruction from the perusal of your very judicious observations on the various sins of omission and commission so prevalent in landscape-gardening, especially on the "errors in grouping," in Vol. VII. of the Magazine. They are most happily illustrated by the diagrams given at page 401. I have often endeavoured to impress on persons laying out pleasure-grounds similar views, as I have afterwards found, to very little purpose; for words are but an imperfect medium for the communication of ideas on such subjects, to those who have not previously had some practical experience. Your diagrams, on the contrary, speak for themselves. The most careless observer can see in a moment, by "looking on this picture and on this," the importance of forming a complete design before he commences his operations; that this cannot be successfully treated without due deference to certain principles; and that a harmonious and beautiful effect can hardly be the result of mere accident. It is very common, and not a little

provoking, to have arguments in favour of design met merely by the declaration, "I hate formality." Every person of taste hates formality, in the vulgar acceptation of the term; but I would impress on the minds of the class of objectors referred to, the fact, that there is a very broad distinction between such formality, and the harmonious effect of an entire pleasure-ground, comprising infinitely varied details, produced by attention to the laws you have so effectively enforced in the article referred to. By the way, I would strongly recommend that article to the attention of Mr. Errington, who has given a plan for a flower-garden in the last Number, p. 564. But I am wandering from the object of this communication, namely, the plantation fence, which I have, after many unsatisfactory attempts, effected to my mind. There must be a fence, but it ought not to be seen: furthermore, the margin of the plantation should not terminate abruptly with high trees; but the line should be broken by trees and shrubs, gradually decreasing in elevation, until the last in the series mingles with the grass. This has been the desideratum with me, and I have thus accomplished it:—Sow furze seed early in the spring, on stony or gravelly banks, on which there is a little good mould, as the plants are thereby provided with much more fibrous root than when the seed is sown on stiff clay soils; keep the plants clean, and transplant them in November, or early in February, to the front of the plantations. Fence them with a post and two-rail fence, which will keep off cattle (the occasional bite of sheep or lambs will rather do good than harm), and keep them hoed. In the following spring, clip off with shears the principal part of the first year's shoots. The plants will make very luxuriant shoots during the next two years, after which the posts and rails are to be removed; the branches of the furze must then be collected in the hand, and drawn forward towards the field, while the posts and rails are again put up on the plantation side of the furze, about a foot or eighteen inches within the stems of the plants; and, as each rail is fixed, the branches of furze are disengaged, and fall back against the fence; so that, at a moderate distance, it is no longer seen. When the furze thus becomes thus laid open, the tender parts of all the young shoots are browsed by cattle and sheep, which makes it grow so thick and close, that, by the time the posts and rails decay, it is a perfect fence to the plantation. Different forms may be introduced, occasionally, to vary the effect, which I can assure you is extremely beautiful, especially when the furze is in bloom. It forms a pleasing natural drapery, and always reminds me of Burns's line, "The lawns

wood-fringed in nature's native taste." This, I may add, is the cheapest of all flowers.

Standard Rose Trees. — As you have condescended to notice, in your Magazine, so simple an article as a flower-stake, perhaps you will admit my recommendation of a support for the French standard roses, which I have found very useful. I send you a sketch (*fig. 146.*) of an iron one. They should be made after the roses are planted, that

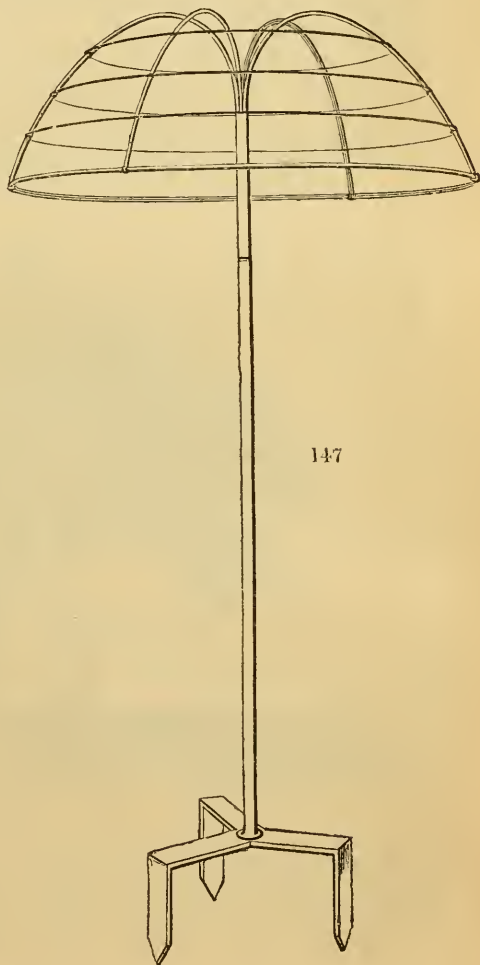
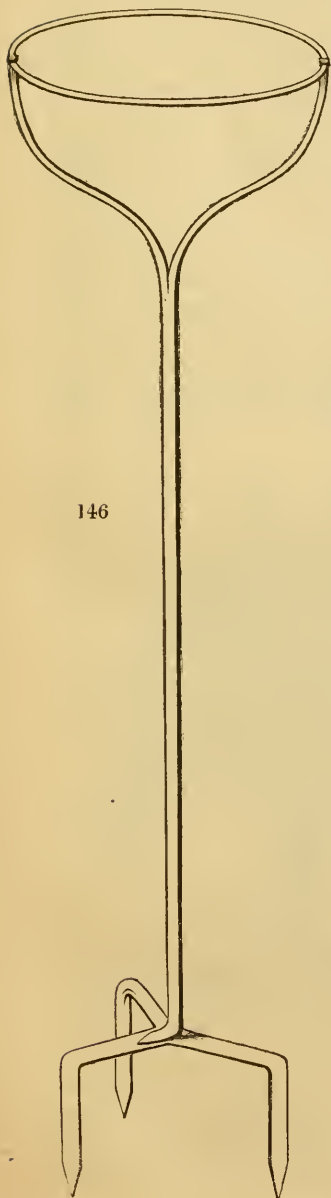

the blacksmith may adapt them, in point of height, to the trees. When fixed in the ground, the ring at the top should stand about an inch or two higher than the top of the stock. This ring is fastened to the two iron limbs of the standard by nuts, and is unscrewed, and hung on one of the limbs while the standard is fixed; it is then raised to its place under the branches of the tree. These standards should not be used until the tree has a sufficient head to cover the top of them. The mode of training I adopt is as follows:—In the spring, I select six or eight of the strongest shoots, and tie them to the ring with tar twine; and if, from their length, this be not sufficient to prevent their blowing about, I confine the end of these shoots to pegs stuck in the ground. All the other shoots are cut back in the usual way. I recommended this mode of training the standard roses to some friends near London, and they were told by their gardeners it would not answer; that the heads of the roses and other stems would become naked, and produce flowers few in number and poor in character. They have since had ocular demonstration to the contrary; and I

148

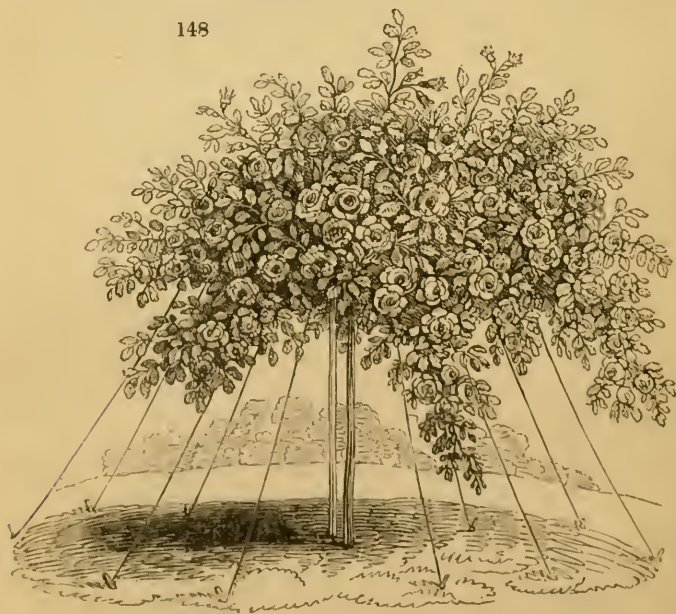

send you an accurate sketch (*fig. 148.*), taken in 1831, from a Bizarre de la Chine, when in flower, which this season reached nearly to the ground, flowered most abundantly to the end of its branches, and was truly a splendid object. This tree is six

years old; those of less vigorous growth should have all the last year's shoots shortened to about an inch beyond the ring, when brought down and tied to it with matting; by which means their heads are more handsomely formed, and their flowers are shown to more advantage, than when the head is suffered to grow upright *en masse*; and I am satisfied that they flower more abundantly. As the appearance of the strings is not very agreeable to a fastidious eye, I send you a sketch (*fig.* 147.) of another standard, very useful for training roses of the most vigorous growth. The price of the former, as charged to me, was 3*s.* 6*d.*, three times painted; and of the latter, 5*s.*

I am, Sir, yours, &c.

CHARLES LAWRENCE.

The Quems, near Cirencester, Oct. 15. 1832.

ART. XVIII. *A Description of a Method of propagating Cape Heaths expeditiously.* By Mr. T. RUTGER.

Sir,

FROM my early days I have been an admirer of plants, both exotic and indigenous; and, among the former, the ericas, or heaths, have always been favourites, as being, in my opinion, one of the most beautiful tribes of plants grown. During a long residence in the west of Cornwall, I was indefatigable in collecting and keeping up a choice assortment of them; and, in order to keep up, as well as collect, I tried many experiments to find out, if possible, a quicker and more certain method of propagating them from cuttings, than by the usual mode adopted, which, however successful, I conceived to be tedious; and, having at length succeeded to my most sanguine wishes, as far as it respected the fast-growing and slender-wooded varieties, I considered myself amply repaid for all my pains.

Early in the month of April, or as soon as the young shoots were about an inch long, I made choice of my cuttings. In taking off and trimming them for planting, they were handled as delicately as possible; as, when so young, they are extremely tender. I then cut them with a keen knife, as near as possible to where they had been joined to the old wood, and put them into a pan of water until I had a sufficient number to make up a pot. This done, I made choice of one suitable in size to receive the striking glass; I filled it up nearly two thirds with the siftings of peat, and the remainder with the peat very finely sifted, which I moderately pressed down. After pressing the striking glass on the mould, in order to

get the line of its circumference, I proceeded, with a dibber about the size of a small quill, to plant the cuttings; which was done carefully, without pressing them much, rather leaving them to be fixed by watering than with the dibber. The pot being filled with cuttings, I watered them, standing at some distance, with a very finely perforated syringe, elevated so as to let the water descend on them like a gentle shower of rain. This was repeated several times, until I conceived the whole of the mould to be completely saturated; after which the glass was set over them, and the pot placed in the front of the green-house. A gentle syringing was repeated every morning for the first three weeks, and, afterwards, every other morning for about three weeks more. At this period many of the cuttings had begun to strike, and, as soon as this was observable, less watering was resorted to. In about ten weeks many of the cuttings were fit for potting off, which was immediately attended to; and, after being potted in thumb pots, they were placed under a hand-glass, or in a cold frame, in a shady situation, where they were gradually hardened by giving air, until they could bear exposure. Great care was taken in removing them from the cutting-pot, by gently raising them with a small piece of wood, cut for the purpose. They generally rose with little balls, round the outsides of which I could frequently perceive numerous small fibres protruding themselves, as white as milk. During several years' practice in raising heaths in the above way, I have many times observed the small fibres striking out two or three joints above the surface, and making their way down the cutting to the mould.

The success of the above mode, I found, rested principally, if not entirely, upon the state of the cutting, and the health of the mother plant. The cutting should neither be of the strongest nor of the weakest growth; and it is almost needless to add that the plant should be healthy from which the cutting is taken. With regard to the varieties of slow growth, it is but seldom that cuttings can be found on them of the kind to insure success by this method, as they are generally too thick and turgid, as well as the sorts too hardy in their growth; but I am convinced that means might be used with many of them, so as to obtain cuttings that would strike in the above way, and of this I once had a proof. On visiting a gentleman's garden, about ten miles distant, I perceived an *Erica* which had been improperly left in a house where early forcing had commenced; it was so drawn that its former habit was completely changed. On asking its name, I was told it was the *E. depréssa*. It instantly occurred to me that

cuttings from it in that state might answer my purpose. Accordingly I begged a few; and the result was, that, under the above treatment, every one of them grew, to the number of about a score.

The species of very easy growth, such as the *ignescens*, *gracilis*, &c., I took less pains with, by putting the cuttings under a hand-glass, on a north border, which, under the above treatment of watering and well draining, succeeded to admiration. I found, by experience, that the sooner the cuttings were potted off after taking root the better; as, by remaining long in the cutting-pot, they became drawn and sickly. Their drawing might be prevented, by confining one sort to a pot, as air might then be given in any proportion; but in my case it was different, having frequently, through the want of a sufficient number of striking glasses, four or five sorts together in a pot, some of which took less time than others to strike. However, under any circumstances, experience taught me that early potting was best, as I found that they would not remain long in a healthy state in the striking-pot. I had not the opportunity of trying how they would strike in sand by the above method, as I could obtain none of the proper kind in that part of Cornwall where I resided. After potting, when the plants begin to grow, if their tops are taken off, they will throw out side shoots; and, during the following spring, form nice little bushy plants. The usual practice of daily wiping the glasses is useless in this mode of propagation.

I am induced to send you the above, in order, if possible, to give a fresh impulse to the growing of this beautiful tribe of plants, vast numbers of which are so very ornamental to the green-house. Many gardeners, no doubt, are great admirers of them; but, through the difficulty often found in propagating them, they are induced to give up the task, and thus deprive themselves of the pleasure they would derive from having a collection of them under their care. On the supposition that from two to three hundred kinds can be propagated by the above simple method, and that some others may be raised from seeds perfected in this country; a choice collection might be kept up at an easy expense, by purchasing now and then a few of those which, on account of their peculiar growth, structure, or delicacy, are difficult to propagate.

I remain, Sir, yours, &c.

Shortgrove, Essex, Sept. 1832.

T. RUTGER.

THESE practical directions, by Mr. Rutger, in conjunction with those imparted by Mr. M'Nab, in his very valuable pamphlet on the same subject (see p. 210.), will, it is hoped, so much avail the lovers of these loveliest of plants, as to cause them to be henceforth far more commonly cultivated. — *J. D.*

ART. XIX. *On the Cultivation of the Droseras and Pinguiculas.*
By ROBERT MALLET, Esq.

Sir,

THE droseras, or sundews, of our bogs have a striking analogy to the *Dionæa Muscipula* of America, and are as worthy of cultivation as native plants, as is the latter as an exotic. There are three species of *Drósera*, natives of Britain: two of which are found in Ireland. The *Drósera rotundifolia* grows about Lough Daw in the county of Wicklow; *D. longifolia*, at Howth; and both in various bogs about Mullingar.

Independently of their singularly beautiful form and structure, and curious motive powers*, they are plants possessing some history, as having once constituted the sole ingredient from which was distilled the celebrated *aqua rosæ-solis*, also called *rosala*, or spirit of sundew. In some old dispensatories it is highly extolled as good for "the sweat," for convulsions, and the plague. In time, the original recipe of this preparation became neglected, and a compound of burnt brandy, sugar, cinnamon, and milk water, scented with musk, was substituted. The best of this was considered to have been made at Turin; but I know not that any such cordial is now known in Italy.

In the time of Louis XIV. another kind of spirit of sundew came into use, the advantages of which are said to have been experienced by that monarch, when afflicted with ague. The name was all the relation that this latter composition bore to the plant, being "an infusion of anise, fennel, aneth, coriander, &c., in Spanish wine for three weeks," and in a short time, even its name was corrupted into "du roy," until finally the compound fell wholly into disuse.

The sum of the virtues of these plants seems to consist in their containing an acrid stimulating volatile principle, like that of horseradish, and the greater number of marsh plants.

There are also three species of *Pinguicula* natives of Britain. Of these the *grandiflora* and *vulgàris* are natives of Ireland.† Few little plants are more beautiful, when in

* The question of the sundews possessing motive powers has been recently raised in the *Magazine of Natural History*, Vol. V. p. 491.; and negative and affirmative answers returned, p. 755. to 758. — *J. D.*

† All three. *Pinguicula lusitánica* has been found on the borders of bogs in Ireland. Mr. J. T. Mackay, in his *Catalogue of the Plants of Ireland*, gives, as its Irish habitats, "Marshy grounds. Foot of Dublin Mountains, &c." I have seen specimens, gathered in 1829, at Killarney, and in the county of Mayo; and have been informed that it occurs in other parts of Ireland

P. vulgàris. A very interesting faculty has been recently ascribed to this species. At the first anniversary meeting of the Berwickshire natu-

flower and seen in the sunshine, with their bright green leaves all a-glitter with their pearly studs.

The structure of the flowers is well worthy of observation. The ingenious and celebrated Dr. Lewis says that the unctuous and glutinous juice is used, in some places, as an ointment for chaps* and scalds, and that it is used by the common people of the mountainous districts of Wales as a powerful cathartic. This juice also seems to possess some specific action on milk. Linnæus says that it prevents either the cream or the whey from separating from reindeer's milk; but that it decomposes cow's milk into curds and whey. Lewis, however, says that "new milk poured upon the fresh leaves on a strainer, and, after quick colature, set by for a day

ralists' club, held at Coldstream, on September 19. 1832, the president, Dr. Johnston (himself the author of a very interesting *Flora of Berwick upon Tweed*, in 2 volumes), delivered an address, in which, among many observations of interest, are the following, appertaining to *P. vulgaris*: — "There is much to learn of the habits and properties of our common plants; and I may mention, as an illustration of this remark, the observation which was made on the butterwort (*Pinguicula vulgaris*) during our excursion to Cheviot. It was then accidentally observed, that, when specimens of this plant were somewhat rudely pulled up, the flower stalk, previously erect, almost immediately began to bend itself backwards, and formed a more or less perfect segment of a circle; and so, also, if a specimen is placed in the botanic box, you will in a short time find that the leaves have curled themselves backwards, and now conceal the root by their revolution. Now, the butterwort is a very common plant, yet I am not aware that this fact of its irritability has been ever mentioned."

In the *English Flora*, vol. i. p. 28, 29., it is quoted from Mr. Drummond, that the leaves of *Pinguicula lusitânica* are permanent in winter, and those of *P. grandiflora* are deciduous. It may be added to the description, that those of *P. vulgaris* are deciduous also; and that, when they have died back, they leave the heart of the plant in the condition of a scaly bulb, in which state it continues through the winter, and, I believe, is, during this period, as devoid of living roots as of leaves. This economy is also possessed by *P. grandiflora*, and, I suppose, by every species of *Pinguicula*. Frost will throw this bulb on the surface of the soil, where it seems to be perfectly unhurt by the frost's action; and it is possible that, on the rising of water during the winter season, in the plant's native places of growth, not a few bulbs get transplanted from one spot of soil to another, and so have a fresh place of growth almost annually. It may be here remarked, that three aquatic plants, the *Stratiotes aloides*, *Calla palustris*, and, I believe, the *Menyanthes trifoliata*, are also increased and dispersed by deciduous axillary bulb-like buds. From this economy in *Pinguicula vulgaris*, I think it is needless to shelter the plant in a frame to protect it from frost; but its concentrated energies, designed for the next year's display, may be preserved from all dissipation by the protection. The peduncle of *P. vulgaris* is pubescent, and, I believe, that of *P. grandiflora* also: this is almost inferable in *English Flora*, but is not clearly declared. — *J. D.*

* Sir J. E. Smith, in his *English Flora*, vol. i. p. 29., says, under *P. vulgaris*, "The viscid exudation of the leaves is reputed to be good for the sore dugs of cows; whence the Yorkshire name of Yorkshire sanicle." — *J. D.*

or two, becomes thick, tenacious, very agreeable and salubrious, and throws off no whey, except it be kept long, and that a little of the milk, so thickened, serves to bring fresh milk to the same state." Probably Lewis never had an opportunity of trying its effects on reindeer's milk, and only alludes to cow's milk. It is said to cause diseases in cattle; but Lewis says no animal will eat it.

I have successfully adopted a similar method of cultivation with both these genera.

Three or four plants are placed in a pot of 5 in. deep, with some pebbles in the bottom, and over them a piece of *Sphagnum*, above which the pot is filled with very fine peat. The use of the *Sphagnum* is, that, whether dead or alive, it enlarges or contracts, by every change of amount of moisture in the pot, and thus always keeps the peat from cohering into a clammy mass, which otherwise it is apt to do.

Instead of being *shaded*, as generally directed, the plants are exposed to the full blaze of sunshine; and it is beautiful to see the leaves of the *drosera*, some dilating themselves to the warmth and light, and others contracting on and imprisoning some "flutterer in the beams," that, in an evil moment, has been tempted by the nectar of the dewy leaves.

The pots are kept plunged to within $1\frac{1}{2}$ in. of the top in water, during the whole summer; and, on the first appearance of frost, are removed to a dry airy frame, and given less water each day, until, by mid-winter, they are dry; in which state they remain until they begin to show signs of vegetation, when they are removed again to their summer quarters. If left exposed to the open air, during the winter, the roots are invariably pushed out of the ground by frost. With this treatment, three small plants, in one season, will completely fill a pot of the size mentioned.

ROBERT MALLET.

94. *Capel Street, Dublin, Aug. 1832.*

ART. XX. *On procuring Two Crops of the Ash-leaved Kidney Potato, in One Year, off the same Ground.* By JOHN DENSON, Senior.

Sir,

IN each of the last two years I have grown two crops of the ash-leaved kidney potato on the same ground, and each of the crops has been a good one. I proceed thus:—In taking up the first crop, I bury the tops or herbage in the trench, by turning the earth between the rows upon them

and this done, the ground is ready to be planted again. My first crop, this year, was planted on the 30th of March, and my second on the 13th of July; the second has been as good as the first, and the potatoes are perfectly ripened: the joint produce of the two crops has been fully at the rate of 960 bushels an acre. I took some of the potatoes of the second crop, of nearly the full size, to market on September the 15th.

First Crop. — It is well known to growers of the ash-leaved kidney potato, that it is difficult to prevent its exhausting itself previously to the time for planting it; and that, if seed potatoes of it are allowed to remain too long in the pit, frequently not one third of them will grow. To prevent this, I seldom put them into the pit before Christmas, and take them out in the latter end of February or beginning of March.

Second Crop. — Those which I intend for the seed potatoes of the second crop I spread thinly on the floor of an out-house where there is a free current of air. This treatment so much checks the growth of the chits, shoots, or sprouts, that these do not become more than an inch long, and are individually furnished with a cluster of roots. I plant the potatoes, with the shoots upon them, in this state; and, in planting them, guard carefully against breaking off any of the shoots.

The potatoes produced in the second crop are the fitter to preserve for the next year's planting, as, when housed or pitted, they are less prone to exhaust themselves by sproutiveness than are the potatoes produced in the first crop.

I have reserved 20 bushels of the produce of my second crop for seed; and intend, next year, to have two crops on all the ground on which I shall plant the ash-leaved kidney. I have planted out plants of the Guernsey cabbage, which will be ready for market in April. By planting the first crop of the ash-leaved kidney, with the chits on, early in May, after the cabbages are sold off, two crops of potatoes and one of cabbages can be procured from the same ground in one year. I may be told that this is exhausting work for the land: I reply, that decayed and decomposed vegetables are the best of manure; and that the more vegetables there are grown, the more is the manure increased in proportion; whilst every turning up of the soil is a species of fallow.

In conclusion, I may notice that my nephew (who assists me in all I do) suggests that, when the first crop of the ash-leaved kidney is taken up before the potatoes are fully ripe (as, in the desire to get them early to market, is frequently the case), it may be well not to bury the herbage from such; as

he has found, in digging up the second crop, that such herbage of the first crop, although immersed in the soil, had produced many minute potatoes: an effect unwelcome to those who, like myself, desire to grow their successive crops unmixedly. It is scarcely necessary to add, that this effect does not result from the buried herbage derived from ripened potatoes; and those of my first crop were quite ripe previous to the 13th of July, the date at which my second crop was planted.

I am, Sir, yours, &c.

JOHN DENSON, sen.

Waterbeach, near Cambridge, Nov. 1832.

ART. XXI. *Minor Communications.*

HATCHING Chickens in the Bark-bed of a Hot-house. — A friend of mine was very successful last year in hatching chickens in the tan pit of a hot-house. His method was to place a half-hogshead barrel in the tan, which was brought up all round it nearly to the top of the cask, and was merely covered with a flat board. The eggs were placed in a basket at the bottom, and covered with a piece of flannel. The heat required is 104° of Fahrenheit; a degree or two above or below that point will not destroy the eggs, but the nearer it is kept to that heat the better. It may be supposed that it will require a great deal of trouble to keep it up to this nicety, but it is not so troublesome as may at first sight be imagined. It may be also asked, what advantage is to be derived from this process, when plenty of sitting hens can be procured? I answer, that the chickens may be hatched much earlier than hens will want to sit; in fact, the hatching may be commenced as soon as eggs can be procured; and, of course, the poultry to be obtained will fetch a much greater price from their early production. They may be easily reared, by being kept in the house where they are hatched, until they are big enough to be put out of doors, which will be in about a fortnight or three weeks. When the cask is once at the proper heat, it may be kept up to the desired point without much trouble, for several months; and the average number of chickens will exceed what is obtained from hens. I have read a French work by De Reaumur, giving a very circumstantial and interesting account of hatching chickens by heat produced by horse dung, and I have produced chickens by that means myself; but the heat requires to be very often

renewed by fresh dung, and the place must be particularly favourable to the undertaking. There is also great risk of the germ in the eggs being destroyed by the damp effluvia arising from the dung, which causes the success to be very uncertain. Besides, every gentleman's gardener has a tan bed at his command. I am also of opinion that many of your correspondents might connect a hot closet with the stove used for heating their houses, or might allow the pipes for circulating hot water, where that system is adopted, to pass through it; by which means it might be kept up to the required heat with very little trouble. With respect to the tan bed, it is reduced to a certainty by the experience of my friend. He has hatched several broods this spring; and I can assure you that the chickens brought up in this way have thriven and increased in size much more than those hatched and brought up by a hen; and that this has been proved several times, by a comparison between chickens hatched in the different modes the same day. I am, Sir, yours, &c. — *A Constant Reader of the Gardener's Magazine.* Chichester, April 17. 1832.

Lord Vernon's new Tillage Hoe. — This implement, which was lately exhibited to the Horticultural Society, is said, in a printed paper, which was distributed at the same time, to "give an expeditious and deep tillage, in many cases superior to digging or forking." In drilling, preparing land for planting, or in earthing up, its use is said to be equally advantageous. It may be had at Mr. Charlwood's, and in Derby. It is nothing more than the Spanish hoe of our correspondent Mentor, figured in our Vol. II. p. 233., but differing from our figure in having a long handle. Similar hoes, with long handles, have been made, at our request, at Weir's manufactory, Oxford Street, since 1826. — *Contd.*

Ficus stipulata Thunberg, remarkably fine in a Stove in the Gardens at Merly House. — Sir, In 1822 I received from my worthy and esteemed friend Mr. Henderson, at Earl Fitzwilliam's, Milton, near Peterborough, some cuttings of this plant. They were struck in the ordinary way; and one was put in a 32-sized pot, and by mere chance placed on the front of the stove, at one end, close against the front sash. The end of this house is not glass, but a brick wall plastered over in the common way. After the plant had stood in this position for some months, without any notice further than receiving a supply of water occasionally, it began to push, and to attach itself to the wall very firmly. It soon reached the bottom of the rafter, and turned up the end of the house just before the rafter, covering about a foot in depth down the wall. In about eighteen months after this, it reached the top end of the

rafter, 18 ft. ; in all, 21 ft. from the pot or root. It now threw its branches downward, covering the greater part of the whole end of the house ; and began turning itself along the back wall of the house, just below the wall-plate. In about three years' time it reached the farther end of the house, 35 ft. ; and in its progress covered about a space of 18 in. wide or deep. On reaching this end of the house, which is glass, of course it could go no farther ; and it now began, as at the other end, to extend its branches downwards, to complete its undertaking, namely, that of covering the whole of the back wall ; which it now bids fair to do, having nearly accomplished that object at the present time : when this is effected, it will have extended from the root 56 ft. by 10 ft. It is now throwing out very vigorous shoots and leaves : the leaves have a deep green, glossy appearance. About September last it first showed fruits, which are now about seven or eight in number, and nearly the size of the common brown fig just before it begins to ripen. Whether these will ripen or not, I cannot say. I have no doubt but that, in the course of the summer, there will be an abundant show of fruit on it ; and I mean to encourage some of its branches over the wire trellis used for the vines under the rafters, to give it a better chance of ripening its fruit. The plant has extended its roots into the solid brick wall in the end of the house ; and a brick compartment, directly under where the pot stands, was filled with mould, not with the intention of giving it support, but for growing some other plants in : this it soon found out, and took possession of, and into it an immensely strong root has found its way ; although the pot which first contained it still remains in the same place as at first, and contains the original part of the root, and has a deep pan under it. I now supply it plentifully with water at the roots, taking care to fill up the pan with water every day, the whole of the contents of which is invariably absorbed before the next day, and very frequently I syringe it all over its leaves, with which it seems highly delighted. I should feel obliged by you or any of your readers informing me whether the fruit is fit for the dessert ; and, should you wish it, I shall feel pleasure in forwarding to you a specimen of the fruit, should it reach to maturity on this plant. I am, Sir, yours, &c.—*W. Wilson. Merley Gardens, Feb. 28. 1832.*

Mr. Wilson, in a subsequent communication (dated June 28. 1832), has informed us, that the first crop of fruits dropped off without ripening, and that the plant is now bearing a plentiful second one. He is very desirous to learn if other correspondents have witnessed its bearing fruit in Britain, whether the fruit has been ripened, and whether,

when ripened, its merits will sustain for it a place in desserts. Information, too, on the native habits of this species, and any use to which its fruit or other parts may be applied in its native country, he is likewise anxious for. In example of the extraordinary vigour of this particular plant, Mr. Wilson remarks, "perhaps you will scarcely credit me when I inform you that its roots have penetrated into the solid brick wall which forms the end of the stove, and has actually forced out door-posts so much, that it has several times become necessary to ease the door that it might be opened and shut. The whole back of the house has now a most beautiful appearance from the fine dark shining leaves of the plant, and the strong healthy shoots hanging in wild profusion all over this space. In the size of the leaves on these shoots, and near the root, there is so great a difference, that you would scarcely believe that both were produced by one plant. The leaves which grow at about 3 ft. or 4 ft. from the root are about $1\frac{8}{10}$ in. in length, and an inch in breadth at their broadest part; while those which are borne on the shoots mentioned are 4 in. in length, and $2\frac{3}{10}$ in. in breadth; their outline in both cases being, as is well known, ovate but pointed." — *W. Wilson.*

On the back wall of the stove in the Cambridge Botanic Garden is a plant of *Ficus stipulata*, which has been growing there these twenty, and very probably thirty, years. It covers several square yards of space, and is often cut back to repress its trespasses. During the fifteen years I have known the plant there, I am not aware that it has ever shown fruit. This species, it is said, thrives in a green-house, and it abounds in the clasping root-like tendrils analogous to those of the common or of the broad-leaved ivy. — *J. D.*

Oxalis Déppeï increases very rapidly as a border plant, particularly when grown in large masses; and its beautiful green and brown trefoil leaves are as pleasing as the flower. It should be taken up before the frost, and kept in pots, nearly dry, all the winter; it should be potted in the end of February, and kept till May in the green-house or frame, and then planted out when the frosts are over. You should strongly recommend it. — *H. B. Chancery Lane, August 7. 1832.*

A Sketch of the History of the Chinese Chrysanthemum. [The following communication is abridged from a paper by E. Rudge, Esq., President of the Vale of Evesham Horticultural Society, which was read at a meeting of that Society, on June 25. 1828.] — Linnæus, in 1753, first published this plant as a species, with two of its varieties, under the name of *Chrysanthemum indicum*, in the first edition of his *Species Plantarum*;

the same plant, under the name of *Matricaria*, having been given by Kämpfer, in 1712, in his account of the plants of Japan, where it is cultivated by the natives in their gardens; and he describes eight double varieties of the genus, of various colours. It is also mentioned by Breynius, Plukenet, Rheede, and Petiver. Thunberg, in his *Flora Japonica*, published in 1784, mentions it to be growing spontaneously near Nagasaki and other places in Japan; and Loureiro describes it, in his *Flora of Cochinchina*, as one of the plants of that country. Rumphius, in his very elaborate work on the *Plants of Amboyna*, published in 1750, is more particular in his information respecting this plant than any preceding author: he mentions five varieties of the white, yellow, and red, as being cultivated at Amboyna; that both the natives and the Dutch plant it in the borders of their gardens, where it does not thrive so well as in pots; and that, if it remains more than two years in the same spot, it degenerates, becomes less woody, and often perishes. The Chinese, by whom it is held in high estimation (as may be observed from its being so frequently found drawn and figured on their porcelain), pay much attention to its culture: they keep it in pots and jars, placing it before the windows of their apartments; and decorate their tables with it at their entertainments; on which occasions, he that produces the largest flower is considered as conferring the greatest honour on his guests. To effect this, it is kept by them in a dwarfish state; and, when coming into flower, of the three blossoms which usually terminate each branch, two are pinched off, by which treatment the remaining flower grows larger. The varieties of this plant, so numerous in the gardens of the Chinese, and cultivated by them with so much art and attention, and become thereby objects of so much attraction to the British gardener, were first introduced from France in 1790, having been brought from China to Marseilles in 1789. Before 1808, eight new varieties were introduced from China by Sir Abraham Hume and Mr. Evans. Between the years 1816 and 1823, seventeen new varieties were added to the list; which has at this time been so much further increased by different importations and cultivators, that there are now upwards of fifty varieties existing in the garden of the Horticultural Society at Chiswick. The great variety and beauty of these flowers, when cultivated to the perfection of which they are capable, render them a superb acquisition to our gardens, and that at a season when our gardens would otherwise have little gaiety to boast of. The facility with which they are cultivated will occasion them to become so common, that our cottage gardens will become as

gay in the months of November and December as the Chinese rose has now made them during the months of spring and summer [and, indeed, autumn may be added.] — *Edward Rudge, F.R.S. L.S. &c., President of the Vale of Evesham Horticultural Society.*

A hardy Variety of Maize. — Fourteen years ago, one Mr. Bradbury, an eminent botanist, called upon me. He was then just returned from his travels in North America, where he had been collecting plants. He had travelled a considerable way up the Missouri, and, when upon that river, he heard of a variety of maize cultivated near the Rocky Mountains, which, he said, he was sure, by the account he received of it, would ripen even in the Highlands of Scotland. As he intended to go again to the western parts of America, he said he would endeavour to get a sample of the seed, and send it to England. A considerable time after this I heard that he had died at St. Louis, soon after his return to America: of course, nothing has been heard of the corn. Now, as there are often considerable sums of money spent to procure, and naturalise to the English climate, foreign plants which neither are, nor will be, equal to the maize in point of real value, I think it would be well worth the attention of some Agricultural or Horticultural Society, or of some private individual who could afford to bestow sufficient trouble and expense, to obtain a variety which would ripen in every part of Britain where other grain would. Any one who has friends in the western parts of North America might, perhaps, obtain some seeds of the variety mentioned by Mr. Bradbury. — *M. Rothwell, Farmer and Nurseryman. Spout Bank, Lancashire, March 29. 1832.*

Rhèum austriacum was figured some few years back in Sweet's *Flower-Garden*. In consequence of its being strongly recommended in that work, I was induced to get a plant; but having some scruples as to the effect it might produce, if used in tarts, I have abstained from using its leafstalks until this year. I find it, in point of flavour, very superior to any rhubarb I ever tasted, having a very strong and pleasant acid; scarcely, if at all, inferior to the unripe gooseberry, and producing no unpleasant effects; in fact, in this last respect, I perceive no difference between it and the rhubarb usually grown for tarts. I am therefore desirous, through the medium of your Magazine, to recommend the cultivation of it very strongly to those persons who generally supply the markets; as I have very little doubt it only requires to be known to become in considerable request. Perhaps the greatest obstacle to its being cultivated for general consumption is the

lateness of its vegetation, as, with me, it is not fit for use before the second or third week in June; but I have planted it in rather an unfavourable situation, with a northern aspect. Probably under other circumstances more congenial, it would come forward much earlier. The leaves are uncommonly large; and I find two or three stalks quite sufficient for a moderate-sized pudding or tart, although I have taken no particular pains to encourage their growth. I have very little doubt that it is susceptible of great improvement, and that it might be rendered as profitable, at least, as the other sort. Should the merits of this species ever become generally known, I feel assured it will suspend the old sort entirely, as the latter has a flatness in the flavour, which renders it very insipid compared with *Rhèum austriacum*. I am, Sir, yours, &c. — *E.*
London, July 11. 1832.

On preventing the Prevalence of the Gooseberry Caterpillar.
 — Sir, I have seen, in your Magazine, recipes for destroying caterpillars, and now do myself the pleasure to communicate one for banishing them from ground infested by them. Suppose all your gooseberry and currant bushes to be planted in squares, in the first week in November: clear away all the weeds from them, and give the whole a good coat of dung close into the stem of the bushes. Then dig a trench one spade deep right down the middle of the rows, throwing the earth on each side over the dung, so that it may be covered 1 in. thick. The whole, when finished, will appear like a plot of potatoes that are called ridges in Ireland, and used to be called lazy beds in Scotland: indeed, the process of covering the dung is the same. In the beginning of April, or just when the buds have fairly broken into leaf, fork up the whole with a dung-fork, fill up the trench, and make the whole level again; but do not rake it at this time. Recollect to be particular in laying on the dung the first week of November, and to fork in the spring as the leaves come out; for, I apprehend, a good deal of the success of the thing depends on this; and, besides, the fruit in size and flavour is improved in a wonderful degree. Gooseberry and currant bushes should not have dung dug in about the roots, nor should the spade be at all applied about them; for nothing is more injurious to them. Whether the juice of the dung destroys the eggs of the caterpillar that are deposited about the roots of the bushes, or whether the extra-heat created by it brings out the caterpillars before there is any food for them, I will leave to the naturalist or curious to determine: but, one thing is certain, whoever follows the above may bid good bye to the caterpillar. It is not requisite to give a heavy coat of dung every season; but trenching

them as above, with a little dung about the stems and roots, and forking in the spring, must not be neglected, or else the caterpillar will appear. Bushes round borders may be served the same as those in squares, by clearing away whatever grows about their roots, laying on dung, and covering with earth. Dung well rotted, from the frames, is what I have always used. I am, Sir, yours, &c. — *James Hart. Drumcondra, near Dublin, Sept. 2. 1832.*

Tobacco. (p. 42. 491.) — Sir, Your correspondents having given sufficient information on the growing of tobacco, I shall merely offer for their information, not having previously seen it in your publication, that, previously to burning it for raising smoke and destroying insects, I pour boiling water over it, by which means I obtain tobacco water of strength proportionate to the quantity of tobacco and water used. I have thus used it for the last ten years with unvarying success; the tobacco being full as useful for fumigation, and the water equal to what I used to buy from the tobacconists, after this process. I shall add, that this discovery was made when I first began to grow my own tobacco, and was made as follows: — In filling Read's fumigating apparatus with unwashed tobacco, I found the instrument soon rendered useless by the melting, as I suppose, of the salt of the tobacco; thereby clogging the orifice of the machine. I then washed the tobacco, dried it, and found it burn perfectly well; and at the same time procured my tobacco water. I am, Sir, yours, &c. — *W. Z. Sept. 24. 1832.*

Langford's Incomparable Grape (Lindley's *Guide*, p. 201.) is preferably increasable by *Eyes or Buds.* — Sir, Mr. Langford, some time back, sent me cuttings of his Incomparable grape. He stated that he prefers raising it from eyes, which he plants like bulbs; and, with the cuttings, he sent me a few eyes cut ready for planting. I have tried both the cuttings and the eyes; and the eyes have made fine shoots and are in leaf, while the cuttings are not. I am, Sir, yours, &c. — *M. Saul. Sulyard Street, Lancaster, April 18. 1832.*

Mr. Pillans's Vines. (p. 629.) — I see a short notice of our Horticultural Association (p. 629.), in which you refer to Mr. Pillans's mode of cultivating the vine, and express your readiness to communicate it to the public. The fact is, that Mr. Pillans takes an eye from a vine in the month of March; and from it produces, in the following April or May twelvemonth, a handsome plant for his master's table, bearing several bunches of fine ripe fruit. Some of your readers will not credit this; but I have seen it: that is to say, I went through Lord Ducie's forcing-houses in May last, and

saw pots of vines with ripe fruit on them. I was informed the eyes had been taken from the parent vines only fourteen or fifteen months previously. I saw others in every intermediate stage of growth between them and the pots in which the eyes had just been inserted; and I understood Mr. Pillans to say that he hoped to produce grapes for the table, in succession, throughout the year, on this plan. I believe that this process has not been communicated to any one. I anticipate your opinion, that all who claim to be citizens in the republic of science are bound to contribute their individual discoveries for the general weal, in exchange for the advantages they reap from a similar devotion on the part of their brother citizens. I quite approve this doctrine, as applied to a certain class; but, I confess, I think that persons in the situation of Mr. Pillans may fairly look for a more substantial compensation for the communication of so valuable a discovery as this, than the occupation of a niche in the temple of Fame; though I would not recommend an address from the House of Commons to His Majesty; which was, for aught that appears to the contrary, gravely presented in a certain case of a similar kind. I think the Horticultural Society should encourage the communication of important discoveries, by professional gardeners, by substantial rewards. Every department of the gardens at Woodchester bears ample testimony to the great skill, attention, and zeal of Mr. Pillans, who is evidently a very meritorious servant. I am, Sir, yours, &c. — *Charles Laurence.*
Cirencester, Oct. 15. 1832.

Canker on young Fruit Trees. — Three years ago, I was much annoyed at finding several young pear trees one mass of disease from top to bottom; which, I conceive, must have been infected when sent to me, three years before, as they were planted in the best of soil. On referring to a work on gardening, I found some palliatives recommended; but it was observed that the most effective plan was, to take up the tree and plant a fresh one. I did not much like throwing away three years' growth of roots, which, I knew, had been extending themselves under every advantage of soil; and I thought of cutting off the heads to within 1 ft. of the ground, and inserting healthy grafts from other varieties. I was told this could be of no avail, inasmuch as the sap, passing through the diseased trunk, would infect the grafts. On consideration, this did not appear to me to be a necessary consequence, as the qualities of the chyle (if I may so term it) secreted from the descending sap, to which the future tree would be indebted for its growth, would depend much more on the scion than the stock. I determined, at all events, to try the experiment,

and headed down and grafted several trees. It has exceeded my most sanguine expectations. The new heads are of extraordinary growth: three of them have borne well this year; the wood of all is extremely vigorous and healthy, and without any symptom of disease of any kind. Many of your scientific readers have probably performed the same experiment, on the same process of reasoning; but, as the result was contrary to the anticipations of several experienced gardeners, I communicate it, in the hope of saving many a useful though cankered stock from destruction. — *Id.*

Monstrous Pear. — Sir, There is now growing, in a garden in this town, a monstrous jargonelle pear, which may be thus described: — From the first bloom, which took place early in the spring, a perfect pear was produced; and, after the pear had grown some time, it sent out a flower from its eye, and produced there a second pear; and the second pear afterwards sent out two flowers from its eye, and these produced two pears: so that now there are four perfect pears growing connectedly. I am, Sir, yours, &c. — *M. Saul. Lancaster, July 8. 1832.*

A pear, with an imperfectly formed second pear protruding from its end, was sent us from a neighbour's garden in Bayswater just after receiving the above communication. A couple of monstrous pears will be found figured in Vol. IV. p. 263. fig. 78. — *J. D.*

On the Use of the Seed-down of Typha for stuffing Bedding for the Poor. — When these seeds are ripe, they fall in great wool-flocks from the stalk; and as *Typha* grows wild in many places, they could be procured in abundance. When beaten for some time, they separate, and open all their balloons, so as to become as soft and as elastic as feathers; and, from their hygrometric expansibility and contractiveness, I apprehend they would never get into clots or lumps if sewed up into a bag or bedtick. I should hope that this hint will be not wholly useless to your *Encyclopædia of Cottage Architecture.* — *Robert Mallet. 94. Chapel Street, Dublin, Oct. 1832.*

A good Ale may be made from the Roots of Mangold Wurzel in the following manner: — Take one third of malt, two thirds of mangold wurzel liquor, and about a fifth part of treacle, adding hops at the rate of six ounces to nine gallons. Barrel and work with yeast in the usual manner. The mangold wurzel liquor is thus obtained: clear the roots, pare off the outer rind, slice and boil till they are quite soft, and then squeeze off the liquor. — *A Friend to the Cottager.*

REVIEWS.

ART. I. *Catalogue of Works on Gardening, Agriculture, Botany, Rural Architecture, &c., lately published, with some Account of those considered the most interesting.*

DON, George, F.L.S.: A General System of Gardening and Botany, containing a complete Enumeration and Description of all Plants hitherto known; with their Generic and Specific Characters, Places of Growth, Time of Flowering, the Manner in which they are cultivated, and their Uses in Medicine and Domestic Economy; preceded by an Introduction to the Linnæan and Natural Systems, and a Glossary of the Terms used. Founded upon Miller's *Gardener's Dictionary*, and arranged according to the Natural System. In 4 quarto volumes. Vol. II. 875 pages, with numerous Woodcuts, 3*l.* 12*s.*; or in monthly Parts, 6*s.* each. London, 1832.

In p. 203. of our current volume we have sketched the scope and plan of this work, and noticed the first volume of it: we have now (Nov. 19.) to announce the appearance of the second volume, just published. Our botanical and floricultural readers who have not already enabled themselves to judge of the work by procuring the first volume, or parts of it, will oblige us by referring to our remarks on p. 203, 204., as their doing this will render unnecessary our again indicating its plan and scope: but, indeed, the full title above given, attentively perused, will alone suffice to do this, if accompanied by one little objection, previously expressed by us on p. 204., that, as the "gardening" notices in the work only extend to directions for cultivating, propagating, and disposing in the garden the genera and species of plants described, the work does not fully answer to one part of its title, that of its being "a general system of gardening." With this slight general objection, we proceed to notice very briefly the second volume.

The second volume commences with the extensive second subclass Calycifloræ, and describes thirty-nine natural orders included in this subclass; and the remainder belonging to it will form the initial part of the third volume. The vast order Leguminosæ occupies in the present volume 385 pages, and so supplies descriptions of a comparatively endless number of

species of the pretty plants of this really ornamental and very interesting, and, we may say, very natural order; for, who does not recognise the pea-podded plants, as they are familiarly called, all the world over? The orders *Amygdalææ*, *Rosacææ*, *Pomacææ*, *Onagrariææ*, *Lythriææ*, *Melastomacææ*, and *Myrtacææ*, all and each of which contain plants so very beautiful, fall into this volume. Perhaps an abatement of our objection above expressed to the gardening title of this work is due to its talented and prodigiously industrious author; for, in glancing through the volume, we see, under *Amýgdalus*, no fewer than eleven pages of gardening information on the peach and nectarine, enumerating the kinds, noticing their comparative qualities and merits, and supplying directions for their successful cultivation both in the open air and in houses. The same kind of information is supplied under *Apricot*, *Plum*, and *Cherry*; *Apple* and *Pear*; and, probably, in several other cases which we have overlooked.

We cannot stay longer on the volume than to say, that, were it only for the strictly botanical stock of information which is amassed into the work, it ought to be possessed by every studier and cultivator of plants in the world, but especially by those of Britain. Especially by those of Britain, because such have previously had no comprehensive work in our native language to which to make access for the determination of the names, habits, and affinities of the plants they cultivate; by those of the continents of Europe and America (and these include nearly all the botanical world), because, independently of this work availing those who know the language in which it is written, in the same manner, and almost to the same extent, as it will the British plant lovers and cultivators, it will be very useful to botanists universally, as supplying to them a palpable indication of the present state of botany in Britain; and this, without incurring to us the charge of gross nationality, may fairly be deemed a pretty accurate indication of the state of systematic botany in the entire world. For, besides the acquaintance with the discoveries in, and contributions to, the science by foreigners, with which their publications, preserved in our libraries, make us acquainted, we possess fruitful original resources in our colonies, our commerce to the remotest shores, and in the enterprise of our travellers, who, for some years past, have manifested a most commendable interest in collecting the necessary materials to extend our knowledge of nature. Of this accumulated stock of materials, a comprehensive systematic catalogue, containing short descriptive notices of the objects enumerated in it, has for some years past been wanted, and this want it is the office of the present work to supply.

Gilpin, S., Esq.: Practical Hints on Landscape-Gardening. Svo. London, 1832. 21s.

We have read this work with pleasure, and only regret that we cannot spare room to enter into its merits at greater length. The name of Gilpin will inspire with respect every one who has perused the numerous excellent works, by the late author of that name, on landscape scenery. Mr. Gilpin was the contemporary and intimate friend of the justly celebrated author of the *Observations on Modern Gardening*; and it cannot be denied that this work, and the writings of Mr. Gilpin, did more, in their day, to improve the public taste in regard to rural beauty, than all the other writings of the same kind, then published, put together. It is no ordinary presumption in favour of the writer whose work we are noticing, that he is collaterally related to the author of the *Essays on Forest Scenery*.

Mr. Gilpin avows his object to be, to reduce to practice the principles of taste developed by Sir Uvedale Price, in his *Essays on the Picturesque*. In his application of these principles to the situation of the house, the character of the surrounding scenery, the approach, and the plantations, we know not that there is a single hint, so far as these hints go, to which we would object; and there is one, on the character of lodges, which is original; viz., that sometimes the character of the lodge should be determined by that of the situation, rather than by that of the house.

We entirely sympathise with the author in his defence of the irregular outlines of plantations on even surfaces, and only wonder that he should attach so much importance to the articles in the *Quarterly Review*, on Sir Henry Steuart's *Planter's Guide* and Monteath's *Practical Forester*; even though they are understood to have been written by Sir Walter Scott. The truth is, that little dependence is to be placed on a fluent writer like Sir Walter Scott, whose main object was effect, on any subject in which science or definite views are required. Witness the rash assertion, in one of the reviews in question, that the degeneracy of the Scotch pine is owing to nurserymen importing the seeds of that tree from Canada. (See our Vol. IV. p. 315.)

We agree also with Mr. Gilpin in his views and statements respecting the *Planter's Guide* of Sir Henry Steuart. However much Sir Henry may have shown of physiological knowledge in his work, he certainly cannot be complimented on his taste in laying out grounds; and, in proof of this, we should quote against him the same passage which has been quoted by Mr. Gilpin, viz., that in which Sir Henry recommends a juvenile work of ours (*A Treatise on Country*

Residences) published at a time when we had hardly attained the years of manhood, as deserving of more attention than the *Essays on the Picturesque*.

The only department of landscape-gardening which we wish we had seen treated more at length in Mr. Gilpin's work, is that which respects the introduction of exotic trees and shrubs in artificial scenery. There are various other beauties besides those of the picturesque, which ought to engage the attention of the landscape-gardener; and one of the principal of these is, what may be called the botany of trees and shrubs. In our opinion, a landscape-gardener knows but a part of his profession, who is not conversant with the numerous families of American and other trees which will thrive in the open air in Britain. Mere picturesque improvement is not enough in these enlightened times: it is necessary to understand that there is such a character of art as the gardenesque, as well as the picturesque. The very term gardenesque, perhaps, will startle some readers; but we are convinced, nevertheless, that it is a term which will soon find a place in the language of rural art. Landscape-gardening, it will be allowed, is, to a certain extent, an art of imitation. Now, an imitative art is not one which produces fac similes of the things to be imitated; but one which produces imitations, or resemblances, according to the manner of that art. Thus, sculpture does not attempt colour, nor painting to raise surfaces in relief; and neither attempt to deceive. In the like manner, the imitator, in a park or pleasure-ground, of a landscape composed of ground, wood, and water, does not produce fac similes of the ground, wood, and water, which he sees around him on every side; but of ground, wood, and water, arranged in imitation of nature, according to the principles of his particular art. The character of this art has varied from the earliest times to the present day; but, profoundly examined, the principle which guided the artist remains the same; and the successive fashions that have prevailed will be found to confirm our view of the subject, viz., that all imitations of nature worthy of being characterised as belonging to the fine arts are not fac-simile imitations, but imitations of manner. To apply this principle to the planting of trees in park or pleasure-ground scenery; nature, in any given locality, makes use of a certain number of trees found indigenous there; but the garden imitator of natural woods introduces either other forms and dispositions of the same kinds of trees, as in the geometric style; or the same disposition of other species of trees, as in the most improved practice of the modern style. In neither case does the artist produce a correct fac simile of nature; for, if he did, however beautiful

the scene copied, the beauty produced would be merely that of repetition. But we have neither room nor time at present fully to illustrate this theory. Let it suffice for us to state, for the consideration of those of our readers who have reflected on the subject, that there is as certainly, in gardening, as an art of imitation, the gardenesque, as there is, in painting and sculpture, the picturesque and sculpturesque.

Matthew, Patrick: On Naval Timber and Arboriculture; with Critical Notes on Authors who have recently treated the Subject of Planting. 8vo, 400 pages. London, 1831. 12s.

In our Number for February, 1831 (Vol. VII. p. 78.), we have given the title of this work, with a promise of a farther notice. This is, however, now so retrospective a business, that we shall perform it as briefly as possible. The author introductorily maintains that the best interests of Britain consist in the extension of her dominion on the ocean; and that, as a means to this end, naval architecture is a subject of primary importance; and, by consequence, the culture and production of naval timber is also very important. He explains, by description and by figures, the forms and qualities of the planks and timbers most in request in the construction of ships; and then describes those means of cultivating trees, which he considers most effectively conducive to the production of these required planks and timbers.

“The British forest trees suited for naval purposes,” enumerated by the author, are, oak, Spanish chestnut, beech, Scotch elm, English elm, red-wood willow (*Sàlix frágilis*), red-wood pine, and white larch. On each of these he presents a series of remarks regarding the relative merits of their timber; and even notices, under each, the varieties of each, and the relative merits of these varieties. Indeed, our author insists particularly on the necessity of paying the greatest attention to the selection, both for planting and for ultimate appropriation, of particular varieties, he contending that vegetable bodies are so susceptible of the influence of circumstances, as soil, climate, treatment of the seed, culture of the seedling, &c. &c., as to be modified and modifiable into very numerous varieties, and that it is an essential object to select the variety most adapted to the circumstances of the plot of ground to be planted. This may be very true; but it is also true that extreme will be the difficulty of diffusing, among those most engaged in the operative processes of forestry, sensitive attention to these points.

“*Miscellaneous Matter connected with Naval Timber.*” Under this head the author has remarks on nurseries, planting, pruning timber, and the relations of our marine.

The last chapter is a political one; and, indeed, throughout the book proofs abound that our author is not one of those who devote themselves to a subject without caring for its ultimate issues and relations; consequently his habit of mind propels him to those political considerations which the subject, "our marine," naturally induces: benefiting man universally is the spirit of the author's political faith.

Two hundred and twenty-two pages are occupied by "Notices of authors relative to timber," in which strictures are presented on the following works:—Monteath's *Forester's Guide*; Nicol's *Planter's Calendar*; Billington *On Planting*; Forsyth *On Fruit and Forest Trees*; Mr. Withers's writings; Steuart's *Planter's Guide*; Sir Walter Scott's critique, and Cruickshank's *Practical Planter*. The author's opinions on the opinions and practices of these writers must avail the patient investigator of arboriculture, and those who delight in the comparison of divers and diverse opinions. This part of the book is one which has been, or will be, read with considerable interest by the authors of the above works and their partisans. An appendix of 29 pages concludes the book, and receives some parenthetical evolutions of certain extraneous points which the author struck upon in prosecuting the thesis of his book. This may be truly termed, in a double sense, an extraordinary part of the book. One of the subjects discussed in this appendix is the puzzling one, of the origin of species and varieties; and if the author has hereon originated no original views (and of this we are far from certain), he has certainly exhibited his own in an original manner. His whole book is written in a vigorous, cheerful, pleasing tone; and although his combinations of ideas are sometimes startlingly odd, and his expression of them neither simple nor lucid, for want of practice in writing, he has produced a book which we should be sorry should be absent from our library. We had thought of presenting an abstract of the author's prescriptions for pruning trees intended for the production of plank; but, on second thought, we shall omit them, and refer the reader for them to the book of the author himself.

Lindley, John, F. R. S. &c., Professor of Botany in the University of London, and Assistant-Secretary to the Horticultural Society of London: An Outline of the first Principles of Horticulture. 12mo, 72 pages. 1832. 2s.

This is a valuable compendium of horticultural maxims. It may be called the gardener's "*Book of Proverbs*." We entirely agree with the professor, in what he states, in his well written preface, that such elementary works "tend essentially to the advancement of horticulture, if the physiological prin-

ciples upon which its operations depend for success were reduced to a series of simple laws, that could be readily borne in mind by those who might not be willing to occupy themselves with the study, in detail, of the complicated phenomena of vegetable life." This is perfectly obvious; because, when the principles of any science can be set forth in a few cogent aphorisms, the whole is more readily comprehended, retained in the memory, and applied, than if they were conveyed in a lengthened train of words. It is not so, however, with the rules of the art or practical operations of gardening. These cannot be taught by axioms: as such they would be of little use to the tyro, and therefore they are almost entirely omitted in the work before us; the author's design being only to mark the principles of the science which connect the operations of the gardener with the physiology and economy of plants.

The book is composed of 369 paragraphs, each of which contains some fact or principle, or some opinion. They are well selected, and expressed with the author's usual ability: the botanical distinctions are accurate, and the physiological allusions *generally* correct. If there be any defects, they are attributable only to the studied brevity and paucity of detail.

Some parts, we must say, are enigmatical, and will only serve to puzzle the practical man. For these defects, however, the professor is scarcely accountable, because they are evidently borrowed notions from our very first authorities, to whom it is perfectly natural Mr. Lindley should be disposed to pay some kind of deference, more especially as, during his most active years, he has been more in the cabinet than in the field, more in the "court than in camp." We do not mean to infer that Mr. Lindley would surrender his own opinion through sheer complaisance; but there are many things in vegetable physiology that it is his duty to speak of, which he has never had time to examine for himself.

Those parts of the book that are, we think, problematical, and which have a pretty strong hold on the public mind, as well as on that of our author, cannot well be adverted to without leading us into a much longer statement than may be necessary on the present occasion; but we would beg leave to recommend to Mr. Lindley himself the reconsideration of a few of his representations, viz., "the secretions which solidify the heart-wood are communicated from the bark inwards." (p. 22.) Who has detected this invisible process? Some leaf-buds are said to be "adventitious, and may be *generated by sap* in a state of great accumulation and activity." (p. 29.) Is this possible? "A flower is in reality a stunted branch." (p. 34.) Does not this amount to a denial that the fructiferous organs have real identity in the system, and to describing them as nothing more than fortuitous associations of inferior appendages? Are the

circumstances on which the belief (that flowers are only stunted branches) is founded, viz., monstrous flowers and fruits, to be taken as the rule of vegetable developement, or should those monstrosities be considered as exceptions?

These few particulars involve all the greater questions relative to the organisable property of the sap; its descent in the autumn; the formation of the new zone of wood on *exogenous* stems; whence derived, and how and when perfected: all which phenomena are still obscure, and of which we have much to learn, and perhaps a good deal to unlearn.

As it is understood Mr. Lindley courts rational criticism, we trust he will excuse the foregoing remarks, as they are, he may be assured, respectfully offered. — *J. M. August 20.*

Lindley, John, F.R.S. &c. &c., and Professor of Botany in the University of London: An Introduction to Botany. 8vo, 557 pages, with six copperplates and numerous engravings on wood. London, 1832. 18s.

This is a richly stored, clearly written book, and one for which every votary of botany, who can afford it, may safely, and without hesitation, spend his money. We wish, for the sake of the science, it were sold at half the price charged for it. The want of such an introduction has been sensibly felt by all who addict themselves to this science, for the space of the last ten years. The reason for this is obvious: within that period it is, or not much beyond, that those views of botany which make its essence consist in acquainting us with the natural affinities of plants have become popular in Britain; and those views having no object in common with the botany previously taught, which had for its object mainly that of enabling the student to distinguish one plant from another, it follows, that with this complete change in the state of botany, its scope and its objects, it must have been accompanied by a corresponding change in the condition of its elementary details. This has been the result. New laws, rules, and terms, speculations, and hypotheses, have arisen in abundance, and the science has in many cases been much elucidated by the application of these: witness the systematic distribution of the cruciferous or tetradynamous plants in De Candolle's *Systema*. With botany in this changed and improved state, the inconvenience which has resulted has been, that, read what modern book on the science one would, a host of new combinations, of mutilations of old ones, and of new terms in which these were enounced, were presenting themselves on every side; and this, with the non-existence, all the while, of a comprehensive, clear, explanatory introduction, to which re-

ference could be made for the solution of every puzzle and every difficulty ; for the introductions previously extant, though good in their day, or in application to the system to which they were formed, were usually found provokingly defective when consulted in relation to the prevailing system of natural affinities. This state of deficiency it is the office of the present Introduction to remedy, by including within itself all the modern views of the science, and of the considerations attached to it, and explanations and illustrations of all the terms employed in it, as devised and published up to the period of putting the work to press. It will be found a most satisfactory volume ; and in closing our notice of it, we have only to express our hope, that, at the expiration of every second year at most, a new edition of it, including all improvements which the progress of the science may have evolved in the interim, will be regularly supplied to the public.

*Hooker, W. J., L. L. D., and Greville, R. K., L. L. D. : Icones Filicum ad eas potissimum Species illustrandas destinatae quæ hactenus vel in herbariis delituerunt prorsus incognitæ, vel saltem nondum per Icones botanicis innotuerunt : or, Figures and Descriptions of Ferns, principally of such as have been altogether unnoticed by Botanists, or have as yet not been correctly figured. In two vols. folio. London, 1831. With the plates coloured, 24 guineas ; with the plates uncoloured, 15*l*.*

These two magnificent but very expensive volumes supply a valuable help to our farther acquaintance with those very interesting plants, the Ferns. They present figures and descriptions of 240 exotic species ; and in the descriptions of these, allusions, in contradistinction, are made to additional species. Some new genera are founded, and new systematic affinities indicated. The species figured and described in the work are from India, St. Vincent's, Jamaica, Quito, the Mauritius, and New Holland ; so that, besides the interest which the species from each country may intrinsically possess, they associate an extrinsic interest, in serving as a sample of all the fern productions of the countries from which they have been severally derived.

In closing this work, the authors present their thanks to various gentlemen resident in the above countries for their valuable assistance to it, by the contribution of native specimens, and by descriptive notices appertaining to them. To Dr. Wallich, in particular, the authors declare their very great obligation, "for continued supplies of the Ferns of the vast continent of India ; and these," say they, "have now

arrived to so great an extent, — and not alone from Dr. Wallich, but also from Dr. Wight of Madras, — that the authors contemplate, under the sanction and patronage of the Hon. the Board of Directors of the East India Company, to form for them a new and separate publication, under the title of *Filices Asiaticæ Rariores* [Rarer Asiatic Ferns], to appear on the same size and plan as the *Plantæ Asiaticæ Rariores*.

Blume, Carolus Ludovicus, M. D., lately Investigator of Nature in the Dutch Colonies of the East Indies, Superintendent of Medicine, and Director of a Botanic Garden there, &c. &c., aided by *Joannes Baptista Fisher*, M. D.: *Flora Javæ, necnon Insularum adjacentium*. With lithographic and copperplate engravings, coloured. Brussels, 1828, folio. Frank, Brussels; Treuttel and Würtz, London.

Dr. Blume's *Flora of Java and the Islands adjacent* is a work of great interest, from the following circumstances: — 1. Dr. Blume is an able systematic botanist; and manifests, by his elaborate elucidation of details, that superficiality is not one of his characteristics. 2. The vegetable furniture of Java has hitherto been but limitedly known in Europe: hence the subjects of the *Flora Javæ* are likely to be interesting from their novelty. 3. The work is executed, both in its plates and letterpress, so admirably, that it is an eligible object for introduction into the best of libraries.

The work is intended to be completed in 100 folio numbers, and of these 35 are already published; but, owing to the late prevalence of political strife in Belgium, the work has been for some time suspended, but its publication will be resumed as soon as the state of Belgic politics will permit. In the interim, the parties interested in the work are endeavouring to make it better known in London, and doubtless other places; and to this endeavour we must say we wish all success; for a work of such merit deserves to be extensively known and possessed. It is true, that, of the 35 numbers published, we have not seen many, and those we have seen are possibly the more attractive ones, as the subjects they contain are mainly trees and shrubs: but even if so, the general tone and character of the work furnish a sufficient assurance that the less attractive portions of it will be at least botanically interesting. From the first number we shall present a short notice of two plants of extraordinary interest: *Rafflèsia Pátma Blume*, and a near relative of it, *Brugmánsia Zippèlii Blume*. *Rafflèsia Pátma Blume* is nearly related to *Rafflèsia Arnóldii* of Brown. Those who have access to the Linnæan Society's *Transactions*

(vol. xiii. p. 227.), or to our *Magazine of Natural History* (vol. i. p. 68.), are already acquainted with the *R. Arnóldii*; but for the sake of those who may not be, we shall, from the latter work, give again the cut (*fig. 149.*), and a short notice

149

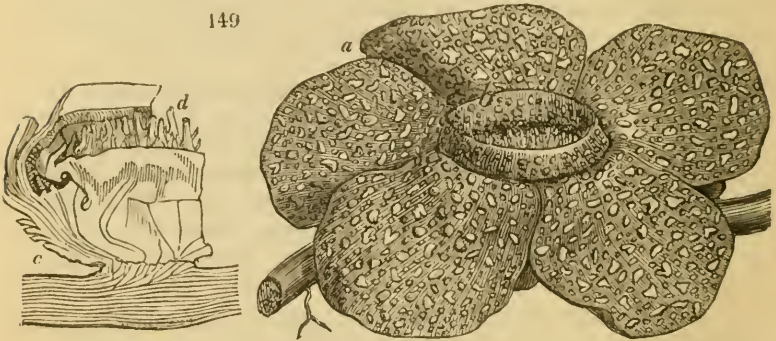

of it. It is a parasite, not an epiphyte (see p. 12. note) on the root and stems of the genus *Vitis* and allied genera. The flower weighs 15 lbs., and constitutes the whole of the plant, which has neither leaves, roots, nor stem. The flowers are dioecious, and the breadth of a full-grown one exceeds 3 ft.; the segments of the perianth (*a*), which are five, are roundish, of a brick red colour, covered with protuberances of a yellowish white, measure 12 in. from the base to the apex; and it is about a foot from the insertion of one petal to that of the opposite one; the nectarium (*b*) would hold 12 pints; the pistils (*d*), abortive in the male flower sent to England, were very large. Its first appearance is that of a round knob (*fig. 150.*) proceeding from a crack or hollow in the stem or

150



root. This knob, when cut through, exhibits the infant flower enveloped in numerous bracteal sheaths, which successively open and wither away as the flower enlarges, until at the time of full expansion (*fig. 149. a*) very few are remaining, which have somewhat the appearance of a broken calyx (*c*). Three months elapse from the first ap-

pearance of the bud to the full expansion of the flower. The female flower differs little in appearance from the male, farther than in being without the anthers (*c*) of the latter. The

flower, fully blown, was discovered in a jungle, growing close to the ground under the bushes, with a swarm of flies hovering over the nectary, and apparently laying their eggs in its substance.

Before noticing *Rafflèsia Pátma Blume*, we should remark that Dr. Blume, in 1825, founded an order to receive this and allied plants, and devised for it the name *Rhizánthææ*; from *rhizē*, a root, and *anthos*, a flower; in expression of the remarkable habit in their vegetation of their being flowers parasitically sustained on the roots of other plants. As M. Brongniart had, in 1824, a year previous, applied the term *Cytíneæ* to plants of the same kind, Dr. Blume's name is superseded by the priority of M. Brongniart's. Dr. Blume, however, in his work before us, published in 1828, retains his own name of *Rhizánthææ*, and under it developes, in considerable detail, its characters, before he proceeds to the contradistinction, description, and illustration of the plants, which, in this work, he has occasion to consider under it. These are, *Rafflèsia Pátma Blume*, *R. Arnóldii* Brown, and *Brugmánsia Zippèlii* Blume. *R. Arnóldii*, above spoken of, Dr. Blume only notices for the purpose of distinguishing his *R. Pátma* from it; and we now give some of his remarks on the latter, and on his *Brugmánsia Zippèlii*.

To *Rafflèsia Pátma* Dr. Blume applies the epithet *Pátma* in expression of its place of growth. This species has the perianth smooth within, while *R. Arnóldii* (*fig.* 149.) has this part rough with filiform excrescences; *R. Pátma* has the processes of the column straightish, *R. Arnóldii* bears the processes in the disk of the column more crowdedly and confusedly, and of unequal length, and here and there somewhat divided and twisted; *R. Arnóldii* is perhaps still farther distinguished from *R. Pátma*, in the former having diœcious flowers.

R. Pátma Blume grows in shady places of the little island of Nusa Kambangan, near to the south of Java, upon the roots of *Císsus scariòsa Blume*, which plant delights exceedingly in moist soil, and where the diameter of the expanded perianth of the *Rafflèsia Pátma* not rarely exceeds 2 Dutch feet (five of which are equal to four English), but in less favourable situations its diameter is scarcely 14 to 16 Dutch inches.

Accurate examination convinced Dr. Blume that the *Rafflèsia Pátma* had no connection whatever with the woody layers of the root of the *Císsus scariòsa*, but that its connection was only with the substance of the bark of the root. It is quite remarkable that the growing bark, having its continuity inter-

rupted by the entrance of the collet of the *Rafflèsia* into its substance, swells out into a cup-shaped process round about the flower-buds of the *Rafflèsia*, and this cuplike process varies in diameter, according to the length of time which may take place between the first rising of the flower-bud and the ultimate fall of the flower itself and its remains. To illustrate this extraordinary plant, a series of drawings, occupying four folio pages, are presented: they show its progressive stages of development and its structure, and are admirably executed.

Brugmánsia Zippèlii Blume. Dr. Blume ventures to apply this generic term to this plant, because he considers that Persoon's genus *Brugmánsia* is not sufficiently distinct from *Datura* L. The specific name *Zippèlii* compliments the person who first found this plant growing on the roots of *Cissus tuberculata* Blume, in moist woods on the south-west declivity of the mountain Salax, and at the height of from 1200 to 1500 feet above the level of the sea. The mountain is situate in the province of Buitenzorg, on the west of Java, and is sacred both to Vulcan and to Flora.

The generic character of Blume's genus *Brugmánsia* are these:—Perianth of one leaf, with the crown of the throat interrupted, limb 5-parted; segments or partitions twice or thrice cleft: the æstivation valvate induplicate; the central column subglobose, hollowed above, and naked; anthers monadelphous, 2-celled, opening by two pores. Dr. Blume states that *Brugmánsia Zippèlii* possesses remarkably stypical powers.

In the other odd numbers which have come under our observation, in the order *Cupulíferæ* several most interesting species of oak are figured and described: the foliage of some of these is magnificent, and the cups and acorns are very striking. In the order *Juglándeæ* there are some species of an interesting genus named *Engelhárdtia* by Leschenault, the nuts of which are furnished with wings somewhat in the manner of our maples, and are disposed in catkins. In *Anonáceæ* a beautiful species of *Unóna*, called *dasymáschala*, to express its having thick shoots, is figured, and has numerous ruby blossoms. Three species of *Artábotrys*, viz., *odoratíssima*, *hamáta*, and *suavèolens*; and several species of the genus *Polyálthia*, are also presented in this order. In *Magnoliáceæ*, six species of *Michèlia* are figured, four of *Taulàma*, and two plants to which the names *Manglètia gláuca* (a shrub) and *Aromadéndron élegans* (a tree) are ascribed. The order *Dipterocárpeæ* is elucidated by numerous details, derived from full descriptions of six species of the genus *Dipterocárpus*;

namely, *D. trinervis*, *retusus*, *Spanòghei*, *littoralis*, *gracilis*, and *Hasseltii*. The essential generic characters of *Dipterocarpus* are, calyx in the mouth irregularly 5-cleft, with two opposite segments longer than the rest, and strap-shaped; corolla 5-petaled, and folded in a convolute manner previously to expansion; the stamens numerous; the anthers elongately linear, and tipped with a bristly point; fruit, a woody nut, not opening, by abortion one-celled, and involucred by the enlarging calyx: the seed in most species is large. It will give some idea of the magnificence of these trees, to remark that *Dipterocarpus trinervis* attains the height of from 150 to 200 feet, and that its elliptical leaves are from seven inches to more than a foot in length, and from four to seven inches broad. The remarkable feature in this family, of each fruit having two wings, as expressed in the word *Dipterocarpus*, is very interesting. These wings are formed by the progressive lengthening of the longer segments of the calyx, and in some species of the genus attain the length of three inches: in *D. trinervis* they are 3-nerved.

In the plan of the *Flora Javæ*, it deserves admiration, that the subjects are arranged in their natural orders, and all the subjects belonging to any one natural order are published consecutively; while in most instances the characters of a natural order are given precedently to the characters, and descriptions, and figures, of the plants included in that order.

Wallich, Nathaniel, M.D. F.R.S. &c.: *Plantæ Rariores Asiaticæ*; or, Figures, coloured, and Descriptions of Two hundred and Ninety-five selected unpublished East Indian Plants. In 3 vols. imperial folio. London, 1832. 36l.

In our Vol. VII. p. 206—212. we have given short notices of a hundred plants figured in the first volume of this very splendid work. Since that time two additional volumes have been published, and with these the work is now completed in three volumes. Two hundred and ninety-five plates of plants are presented, and an engraved map of India, which is deemed equivalent to five plates of plants. On this map are indicated the routes of the following travellers who have severally explored various parts of India, to the end of increasing our acquaintance with the plants of that vast continent:—Mr. Finlayson, Dr. Hamilton, General Hardwicke, M. Leschenault de Latour, Mr. Moorcroft, Mr. Royle, Colonel Sykes, Dr. Wallich, and Dr. Wight. India abounds profusely in species of plants; and many of them are extraordinarily beautiful, as is testified by not a few of the figures of those selected for illustration in the work of which we are speaking; but we

really underrate this work, and do it an injustice, if we leave ourselves understood that it only acquaints us with those 295 plants, of which figures have been given: it contains, besides, some lengthy contributions to systematic botany of great value. This has happened in this wise. Dr. Wallich, on visiting Europe, brought with him, in addition to original drawings, stores of specimens; and these, the latter at least, have been distributed to the botanists of Europe, according to the natural families with which they were severally known to be best acquainted. The result has been a greater degree of accuracy, and a richer effusion of information, under each species, than could have arisen, had the authorship of the work been vested in any one person, however eminent. Besides the valuable descriptions proper to the species illustrated, there are the following still more useful communications. A monograph, in the second volume, on the *Laúrínæ* of the East Indies, to which there is a supplement in the third volume, both by Professor Nees von Esenbeck. This occupies 22 pages, and develops the most complete account of the order any where extant; and gives a digest, and the characters, of the genera and species which range under it. Professor Nees also elaborates, in the same manner, in the third volume, the ordinal, generic, and specific characteristics of those lovely plants the Indian *Acanthàcææ*; and this valuable elucidation of this family occupies 48 pages. Professor Meisner, also, in the third volume, presents a synopsis of those plants of the natural order *Polygònææ*, which belong to British India, so far as specimens of them exist in the vast herbarium which has been collected under the direction of the East India Company, and by them recently presented to the Linnæan Society of London; an act of munificence which does honour to the Company. In vol. iii. p. 27., Professor Martius, too, elaborates the characters of the Indian *Eriocaúleæ* and *Xyρίdeæ*.

Hooker, W. J., LL.D.: The Botanical Miscellany; containing Figures and Descriptions of such Plants as recommend themselves by their Novelty, Rarity, or History, or by the Uses to which they are applied. 8vo. London, 1832. In quarterly parts, 10s. 6d. each.

Part viii. of this work was published on the 1st of August last, and contains the following papers: — 1. “Contributions towards a Flora of South America, and the islands of the Pacific. By Dr. Hooker and G. A. W. Arnott, Esq. A.M. F.R.S. &c.” This paper occupies 83 pages, and is to be continued in a future number. It enumerates 384 species of plants, specimens of which have been received from

Messrs. Cuming, Bridges, Matthews, Tweedie, Macrae, Cruickshanks, Gillies, Lay, Collie, Douglas, Scouler, and others, and are preserved in herbariums in this country. We say "enumerates," because some of them, being previously known species, are only indicated; but the majority of them are, and among them some new genera, now described for the first time: consequently, this paper is a very important contribution to systematic botany, both in Britain and all the world over. A genus, nearly allied to *Dràba*, is dedicated to Mr. Mathews, by the name of *Mathéwsia*. Mr. Bridges, too, of whose diligence in collecting the paper supplies gratifying evidence, receives like honour in an interesting genus of shrubs, in the order *Rutàcæ*, named *Bridgèsia* after him. Three new species of lupine are described; and, amongst them, one (*Lupinus albescens*) is termed a "fine species." Ten new species of *Oxalis* are described; and four new species of *Viola* of peculiar aspect (of three of which figures are given), which "constitute a natural little group of *Viola*, remarkable for the crowded and stellate disposition of their leaves, which are strongly fringed with woolly hairs." We must not, however, pretend to notify the genera to which additions are made. It pleases us to see that the following natives of Britain are also inhabitants of South America: — *Ranunculus sceleratus*, *Fumària capreolata*, *Cardamine hirsuta*, *Sisymbrium officinale*, *Lepidium ruderale*, *Capsella bursa pastoris*, *Sagina procumbens*, *Arenaria rubra*, *mèdia Dec.*; *Cerastium vulgatum*, *latifolium*, *arvense*; *Geranium pyrenaicum*, *columbinum*, *dissectum*, *Robertianum*; *Erodium cicutarium*, *moschatum*; *Oxalis corniculata*; *Medicago sativa*, *minima*, and *denticulata*. The plants figured in the illustration of this paper are *Mathéwsia foliosa*; *Viola congesta*, *volcanica*, and *Asterias*; *Crinodendron Pátagna*, a Chilean tree, thought to belong to *Elæocarpeæ*; *Tricomaria Usillo*, a shrub from Mendoza, a genus allied to *Bannistèria*; *Bridgèsia spicata*, *Genista elegans*; *Adèsmia elegans*, *trifoliata*; *Gourlièa decorticans*, a genus in *Leguminosæ*, named by Dr. Gillies in memory of the late Mr. Robert Gourlie, who botanised successfully at Mendoza, and lately died there. The second paper is an abstract of the proceedings of the natural history society of Mauritius in 1830 and 1831. The third paper is a continuation of an Enumeration of Ferns, by Drs. Greville and Hooker. The fourth paper is on the Genus *Saròthra* and its affinities, accompanied by a figure and description of *S. Drummóndii*. The fifth paper is "On *Cardamine rhombóidea* and *rotundifolia* of North America," of each of which a figure is given. The sixth paper is a

“Notice to the members of the Unio Itineraria, with a list of the plants collected in 1831.” The seventh and last paper, which is not completed, is one of much and popular interest. It is entitled “A Sketch of the Province of Emerina, in the Island of Madagascar, and of the Huwa, its inhabitants; written during a year’s residence by the botanists, Charles Theodore Hilsenberg of Erfurth, and Wenceslaus Bojer of Prague in Bohemia: with an Appendix on the Tanghina poison *Tanghina veneniflua*.” Of this plant, a double plate, coloured, is given, and which seems identical with *Cérbera Tánghin* of the *Botanical Magazine*, although this identity is not declared. Besides the figures we have indicated, there is one of *Polypodium melánopum*, and one of *Cryptogramma retrofrácta*, to which we see no description.

Nees von Esenbeck: Genera et Species Asterearum.

This is reported to be a work which will greatly avail those engaged in the study of the species of the genus *Aster*, and of the allied genera: see Professor Lindley’s opinion of it in a quotation presented, p. 723.

Smith, Sir J. E., M.D. &c., and Sowerby, James, F.L.S. &c.: English Botany; or, coloured Figures of British Plants, with their essential Characters, Synonymes, and Places of Growth. The Second Edition, arranged according to the Linnæan Method, with the Descriptions shortened, and occasional Remarks added. London. In 8vo numbers, 1s. each; monthly, or oftener if desired.

We are glad to see a cheap edition of this excellent and far-famed work supplied to the public on terms that will render it obtainable by many whose circumstances would never warrant their purchasing the first edition. That edition, which sells for 55*l.*, extends to 36 volumes, and includes figures and descriptions of 2592 native plants, 1087 of which, exclusive of 55 ferns, are cryptogamic, or, as far as our naked eyes are concerned, flowerless plants. From this second edition all such are to be omitted; and even the figures of flowering plants, “which represent such nearly allied species as may be readily distinguished by the descriptions from those figured.” By this omission of some species, “it is supposed that about 1200 plates will contain the flowering plants, which may be bound in six volumes; and, as most of them are ready, no delay is likely to occur.” As, however, some purchasers may prefer to possess a figure of every plant described in this edition, Mr. Sowerby proposes to supply

impressions, and coloured, of all the omitted plates, at 3*d.* each.

The plates employed will be those used for the first edition, except in some few instances of error, where new ones will be substituted. In this second edition the plates are published in the order of the Linnæan classes and orders, with the names of the plants engraved on the plates: the impressions are taken off on smaller paper, and have their colouring less highly finished, than those in the first edition.

The descriptions are published collectedly, and, like the figures, in the order of the system of Linnæus. They are condensed from those in the first edition, and, the editor trusts, without omitting any thing material; while, from the increased accuracy which the progress of botanical research has effected, they will be occasionally improved. In the names of the plants some few indispensable changes will be admitted. To each genus is added the name of the natural order to which it belongs, and a few general remarks on the habits and properties of the species of the genus. These are useful additions.

Of the six numbers published we shall remark on the first four, in explanation of the manner of publication, that Nos. 1, 2, and 3. contain five plates each, without any descriptive text; but No. 4. contains three plates and a sheet of letterpress, in which the 18 species figured in the four numbers are described, and nine species besides, the figures of which are omitted. In this manner, through the work, the letterpress is to be supplied when the descriptions have become numerous enough to fill a sheet. Mr. Sowerby, in his address, hopes "that the many intelligent persons whose means are limited, may be induced, by the low price at which this edition of *English Botany* is published, to avail themselves of the opportunity of acquainting themselves with the vegetable beauties disclosed around them;" a hope in which we heartily concur.

Anon.: British Flowering Plants, drawn from Nature, and engraved under the direction of William Baxter, A. L. S. F. H. S., &c., Curator of the Oxford Botanic Garden. In 8vo numbers, each containing four plates and descriptive letterpress. With the plates coloured, 1*s.*; uncoloured, 6*d.*

Another very cheap work, devoted to the illustration of British flowering plants. It is "to be confined to a single specimen of each genus, which will be sufficient for all general purposes." In the first number the species figured are *Fritillaria melægri*, *Tulipa sylvéstris*, *Gœum rivale*, and *Viola*

canina: in the second number, *Polygonum Bistorta*, *Paris quadrifolia*, *Adonis autumnalis*, and *Ophrys apifera*. The plants are well drawn and engraved, the first six of the eight, in particular; but the colouring, in our copy, of the 4th, 7th, and 8th subjects, admits improvement. Each species has a separate leaf allotted to the description of it, in which the Linnæan class and order and natural order to which it belongs is stated, and the generic and specific names, characters, and etymons given, as well as synonymes, habitats, a detailed description, and the uses, if any, to which the species is applied. Dissections of the parts of the flower which characterise the genus are given on the plate, and explained in the text.

Mackay, James Townsend, M. R. I. A. A. L. S. &c. &c.: A Catalogue of the Phænogamous Plants and Ferns found in Ireland, with Descriptions of some of the rarer Sorts. Dublin, 1825. 4to, 98 pages.

We notice this book, retrospective as is its date, for the sake of connecting it with Mr. Mackay's interesting communication on some newer discoveries, in our Vol. VII. p. 230.; where, if we mistake not, this catalogue is alluded to as the list published "in 1804," which is doubtless a misprint for 1824. The present is a useful catalogue, for its indication of habitats, and for the original remarks sprinkled through it: but its size is inconvenient; and as Mr. Mackay probably contemplates a second edition, we hope he will, in consideration of the pockets of botanical travellers, make choice of duodecimo pages, and type as small as nonpareil. Botanical explorers are most frequently youthful, and can therefore read small print readily enough.

Mantell, Joshua: A Chart of Floriculture, comprising the Propagation of Stove, Green-house, and hardy herbaceous Plants; hardy Trees and Shrubs; with the Soils best adapted to their Growth. A folio sheet, 30 in. by 21 in. 1832. Published by J. Baxter, Lewes, Sussex. Reprinted from the second edition of Baxter's *Library of Agricultural and Horticultural Knowledge*.

Information on the best modes of propagating plants, and the soils fittest for their healthful growth, is, as the above title indicates, the express object of this chart. This object is very well achieved by digesting into separate alphabets the genera of stove plants, of green-house plants, of hardy trees and shrubs, of hardy herbaceous plants, and of annual and biennial plants; and by appending to the end of each generic name letters and figures which represent certain detailed

meanings explained at the bottom of the chart. The genera, as thus classed, and with information thus appended to them, are stated to be nearly 4000 in number, and they form 18 longitudinal columns; and, says the author, "as the species require the same treatment as the genus to which they belong, the chart may be said to embrace the cultivation of between twenty and thirty thousand of the most interesting productions of the vegetable kingdom." We cannot better explain the mode of using the chart than by quoting the author's own "directions;" but, before we do so, we ought to observe that he enumerates 21 modes of propagating plants, or of treating the cuttings, &c., while in the course of being converted into plants, and these modes are severally numbered. He enumerates, also, of soils and composts, 14 kinds, and distinguishes each kind by a capital letter of the alphabet. Then, "should," says he, "the culture of any species of plant be required, it will only be necessary to turn to the genus to which it belongs. For illustration: let *Abròma*, under stove plants, be taken as an example. Opposite to this we find. 1. 6. E. By referring to the modes of propagation, we learn that the plant may be raised, 1. by seed; 6. by cuttings of the young wood planted in sand under a bell-glass, and placed in a shady part of the stove or green-house, and that the cuttings are liable to damp off, unless the accumulated moisture be occasionally wiped from the glass. Under soils, it will be seen that E. indicates equal parts of loam and peat, as best adapted to the growth of the genus. Annuals and biennials being uniformly propagated by seeds, it has been deemed only necessary to point out their habits and places of habitation: these are designed by the following abbreviations:—A. annual, B. biennial, H. hardy, T. tender, G. green-house, S. stove."

We have bestowed thus many words on this chart, because it is certainly the most comprehensive synopsis of directions for propagating plants, and accommodating them with the soils they require, which has ever been published. It is an important improvement of the 11th and 12th columns in our *Hortus Britannicus*: in those columns of that work, the mode of propagation and soil are generally stated; in the chart before us, where these two particulars have been almost the only objects of the author's attention, they are stated with more definiteness, precision, and detail. The author adopts our accentuation of the generic names, and of indicating whether they be of classic, commemorative, or aboriginal origin. We need not remark to the young gardener, for whose sake we have noticed this chart at such length, how practicable it is to apply the same principle of conspectiveness and of abbreviation, by arbitrary short-hand characters, to other objects.

Anon.: The Cape of Good Hope Literary Gazette. Cape Town. 4to. In periodical Numbers. 20s. per annum.

A miscellany designed to supply intellectual gratification to the readers of Southern Africa. No. 13., published June 1. 1831; and No. 14., published June 29. 1831, have been sent us. Each contains 12 quarto pages of matter, disposed in triple columns; and a portion of this space is occupied by original contributions on various topics, general and local, entertaining and instructive. Then follow "critical notices" of new publications, and "extracts literary, scientific, and miscellaneous." The work appears to be well conducted.

Mr. Bowie, our valued correspondent, in No. 13. contributes "a list of some of the most conspicuous indigenous plants blossoming in the month of June, at Wynberg and its vicinity," in which the names of nearly 100 species appear; and Mr. Bowie, in his introductory remarks, states that these, "together with 200 species more, may be observed in flower in a walk of two or three hours," and that all these are "only a part of the *winter embellishments* of the vegetable kingdom in this part of the world." No. 14. contains a similar list for July, in which the species, although almost as numerous, are all distinct from those in the June list. Both lists are introduced by a few sensible remarks; and in the July one there is this note under *Hesperántha*, where *H. cinnamòmea*, *falcàta*, and *pilòsa* are the species mentioned; but the note is appended to the generic name, and is probably meant to relate to every species of the genus, rather than to any particular one: — *Hesperántha*, evening flower; Dutch, Avondbloem; which emits a most delicious fragrance, and, in the neighbourhood of Cape Town, is the violet, the cowslip, and, the primrose, the harbinger of spring in Southern Africa. Hence a bunch of these beautiful flowers is carried in triumph into the town. That the inhabitants are not destitute of the love of flowers, is quite evident from the numerous groups botanising on our mountains, *awaiting the appearance* of, and eagerly plucking this pretty evening flower." In the lists are the names of many species of plants existing in our collections. In the numbers before us are notices of the South African Literary Society, South African Institution, South African Library, and the Graham's Town Library; and there seems much interest prevailing on literary subjects in the colony.

Doyle, Martin, Author of Hints to small Holders, &c.: Hints on Emigration to Upper Canada; especially addressed to the Middle and Lower Classes of Great Britain and

Ireland. 12mo, 2d edition. Dublin, 1832, Curry jun. and Co.

The author decidedly prefers Canada to the United States. "In no other country in the world," he says, "can such comforts and advantages be obtained in exchange for labour and industry; but, at the same time, I do not recommend those who enjoy happiness and comfort at home, even with a life of toil, to emigrate on mere speculation." As to the part of Canada that Mr. Doyle prefers, he says:—"So impressed am I with the advantages which are offered to the settler in Upper Canada, that, were I not engaged in public and private duties, I would join the first merry-hearted set of Irish emigrants in planting ourselves and our potatoes in one of the richest townships in the Huron territory."

Anon.: Opinions of several eminent Medical Men with regard to Vegetable Diet in reference to Cholera. Pamph. 8vo, 32 pages. London, 1832. 3d.

The apprehensions of cholera which were entertained in London in July and August last, and an impression which then prevailed, that eating of fruit and vegetables would predispose the body to receive this disease, went well-nigh to ruin the market-gardeners, inasmuch as these causes seriously diminished the consumption and sale of their productions. Hereupon a committee of the Market-Gardeners' Society addressed a letter to those physicians whose letters are published in the pamphlet, soliciting their several opinions on the connection which might obtain between vegetable diet and the cholera disease. Thirty letters from as many medical men, twenty-nine of them M. D.s, received in reply to this letter, occupy the pamphlet, headed by a preface, from which we learn, without reading the letters, "that the impression of fear in the public mind with regard to vegetable diet may be entirely removed, and confidence again restored; as the general use of vegetables, as hitherto, is not only not injurious, but highly beneficial and valuable."

Various Writers: Transactions of the Albany Institute from 1828 to 1830. 1 vol. 8vo, 240 pages, with plates. Albany, 1830, Webster and Skinners.

This book contains some useful papers. They, however, appertain more to the natural history of the state than to the art of gardening as practised in it. Art. 3., by Dr. Beck, "On the Geographical Botany of the United States," contains some interesting notices of plants. The book supplies gratifying evidence that the inhabitants of Albany are arduous in researches for the acquisition of knowledge.

GERMANY AND SWEDEN.

Antoine, F., Court Gardener in the Royal and Imperial Paradise Garden at Vienna: *Abbildung von 51 Pfirsich Sorten nach der Natur*. Figures from Nature of 51 Sorts of Peaches. Vienna, 1816—1821.

This is an abridgment, which costs at Vienna about 30s., of a work in folio by the same author which costs more than three times the money. The figures are remarkably well executed; and the descriptions, as we are informed by M. Rauch, who lent us the work, and by Mr. Thompson, the author of the Horticultural Society's Fruit Catalogue, judicious and correct. We have no very high idea of the utility of figuring such fruits as the peach, melon, strawberry, gooseberry, &c., which are of short duration; constantly undergoing alteration by the introduction of new sorts raised from seed; and, in consequence, the fashionable sorts of which are continually changing. However, they are certainly better worth figuring than hybrid pelargoniums and florist's flowers; and therefore let the work pass.

Wenström, John Peter: *Handbok i Blomsterkulturen för Fruntimmer*. 8vo, 293 pages. Stockholm, 1831.

This work treats of 450 species of blooming plants, none, or but few, of them rare in English collections; but all of them showily flowered, and well suited to the decoration of flower-gardens. They are assorted into separate alphabetic lists, under the classes of annuals, perennials, bulbous and tuberous rooted plants, flowering shrubs, and plants for the orangery or green-house. Under each species is given a short history, usually of but a few lines, but sometimes extending to half a page, or even a whole one. This history imparts the same kind of information as is supplied in our *Hortus Britannicus*, but in a fuller manner: it is terminated by an explanation of the generic name; and the history or description is preceded by the French and Swedish names of the plant, which follow the botanical systematic one. The work is closed with an index of the botanical names, a second of the French ones, and a third of the Swedish ones. It is a convenient and useful manual, for those who are familiar with the language in which it is written, and who are desirous to learn, in a ready manner, what are the fittest plants to procure for effecting any particular instance of decoration they may desire.

MISCELLANEOUS INTELLIGENCE.

ART. I. *Floricultural and Botanical Notices of new Plants, and of old Plants of Interest, supplementary to the latest Editions of the "Encyclopædia of Plants," and of the "Hortus Britannicus."*

Curtis's Botanical Magazine; each monthly Number containing eight plates, 3s. 6d. coloured, 3s. plain. Edited by Dr. Hooker, King's Professor of Botany in the University of Glasgow.

Edwards's Botanical Register; each monthly Number containing eight plates; 4s. coloured, 3s. plain. Edited by John Lindley, F.R.S., Professor of Botany in the London University.

Sweet's British Flower-Garden; each monthly Number containing four plates; 3s. coloured, 2s. 3d. plain. Edited by David Don, Esq., Librarian to the Linnæan Society.

Loddiges's Botanical Cabinet; each monthly Number containing ten plates; 5s. coloured, 2s. 6d. partly coloured. Edited by Messrs. Loddiges.

The reader will find the few abbreviations used in the following extracts explained in p. 12.

DICOTYLEDONOUS POLYPETALOUS PLANTS.

XXII. Berberidææ.

390. *EPIME'DIUM*.
diphylum B. C. two-lvd 3x Δ cu ½ my W Japan 1830? D It. l Bot. cab. 1858

This is a curious little plant, very little known. We obtained it from our worthy friend, M. Schuurman, of the Leyden Garden, into which it has lately been introduced from its native country. It appears to be quite hardy, and may be increased by dividing the roots. (*Bot. Cab.*, Oct.)

LXXXVII. Leguminosææ.

1263. *DAVIESIA*.
10612a virgata Can. twiggy 4x □ pr 2? jn Taw. Blue M.N.H. 1827? C sl.p Bot. mag. 3196

Another of the numerous interesting discoveries of Mr. Allan Cunningham. It inhabits the more elevated dry, barren, parts of the Blue Mountains of New Holland, where it flowers in October: in the green-house at Kew, its blossoming season is June. Mr. Cunningham observes that it appears to be allied to *D. racemulosa* of De Candolle, and to *D. umbellata* of Smith; but that it is really distinct from both. A twiggy shrub, with alternate narrow leaves and numerous axillary somewhat corymbose racemes, each consisting of from four to seven flowers. (*Bot. Mag.*, Nov.)

LXXXVIII. Euphorbiæææ. § Euphorbiææ.

1460. *EUPHORBIA*.
cruentata *Grah.* red-spotted-lvd 3x Δ cu 2? au.s Ap St. Louis 1831? S sl Ed.n.ph. j. no.26

This species is described in detail by Dr. Graham in the *Edinburgh New Philosophical Journal* for Oct. 1832, No. 26. p. 361. "Seeds of this plant were sent, along with specimens, to this country from St. Louis, North America, by Mr. Drummond. When is not stated, neither is the height of the stem. "The plants flowered in the green-house of the Edinburgh Botanic Garden in August and September." Notwithstanding this, we

have presumed the species to be hardy. The petioled, lanceolate, unequally serrated, hairy leaves, which are 2 in. long and 10 lines broad, are "irregularly sprinkled above with dull red spots," and this is the property expressed in the epithet *cruentata*.

CXXI. *Pittosporæa*.

679. PITTOSPORUM.

angustifolium B.C. narrow-leaved \square cu 1? jn Y N.S.W. 1830. C 1p Bot. cab. 1859

"This has lately been introduced from New South Wales. It is of a delicate habit, having a few slender straggling branches, and it flowers in June." (*Bot. Cab.*, Oct.)

CXXXII. *Malesherbiacæ*.

3472. MALESHERBIA.

29001a *coronata* D. Don faux-crowned \circ or $2\frac{1}{2}$ jns B Chile 1832. S It Sw.fl.gar.2.s.167

Of this interesting genus, six species, native to Peru and Chile, are known to botanists; and two of them are already in cultivation in Britain. *M. humilis* is registered in our *Additional Supplement*, p. 593. *M. coronata*, the second species, which, as well as *M. humilis*, and some other species, is annual, has been raised by Mr. Thomas Brown, of the Highgate Nursery, from seeds collected in Chile by Mr. Hugh Cuming; from whose rich herbarium Mr. Don had previously described *M. coronata* and three other species. *M. coronata* has an upright, branched, pubescent stem, and rather long, linear, narrow, toothed, pubescent leaves. From the axils of the diminished leaves on the branches are produced the blossoms, and not sparingly. These have a short green tube, on the top of which are seated five green spreading calycine segments, and, alternate with them, five blue petals; so that the ten segments together form a slightly starry blossom, green and blue in colour, orbicular in outline, and equalling a penny-piece in size. The plant flowered with Mr. Brown in September last: it requires a light sandy soil, and is increased by seeds. (*Sweet's Flower-Garden*, Nov.)

The genus *Malesherbia*, in natural affinity, is between the genera *Passiflora* and *Túrnera*; and is in *Monadéphia Pentándria* of the system of Linnæus.

CXLVI. *Galacineæ*. *Francòa sonchifolia* is figured in Loddiges's *Botanical Cabinet* for November, t. 1864: it has rosy petals, with a feathered purple stripe down the centre of each. With Messrs. Loddiges "it grows freely, with a stem 2 or 3 ft. high, flowering in July. It is a coarse-looking plant in its herbage, but the flowers are numerous and beautiful. They are likely to be followed by seeds, by which it will be readily multiplied. The soil should be rich loam." This species is already in our *Additional Supplement*, but less perfectly than we now give it:—

+28870 *sonchifolia* Feu. Sow-thistle-ldv \pounds \triangle or $2\frac{1}{2}$ jl.au Ro.P Chile 1830. S r.l Bot. cab. 1864

DICOTYLEDONOUS MONOPETALOUS PLANTS.

CLXXVII. *Stylidiæa*.

2581. STYLIDIUM.

22824a *hirsutum* R.Br. hairy-scaped \pounds \triangle or $\frac{2}{3}$ my.jn Ro Kg.G.'s Sd.1830? S s.p Bot. mag. 3194

This species has newly come into cultivation; and its purplish rose-coloured corollas, yellow in the throat, are larger than those of any species in our gardens. Mr. M'Nab raised the plant figured from a seed taken off a native specimen, sent to him by the late Mr. Fraser. It blossomed in the green-house of the Edinburgh Botanic Garden through May and the early part of June. (*Bot. Mag.*, Nov.)

Stylidium junceum is minutely described by Dr. Graham, in the *Edinburgh New Philosophical Journal* for Oct. 1832, p 364., whence we are enabled to fill in the blanks which appear under this species in the *Add. Supp.*, No. 29277.

†29277 *Juncum R. Br.* rushy $\text{¥} \Delta \text{cu } 2 \text{ s}$ Ro Kg.G.'sSd.1830. S p.1

“This plant is perhaps less ornamental than any of the species hitherto introduced into cultivation, but still interesting.” (*Graham.*)

CLXXXVI. *Compósita* § *Asterææ*. *Aster spectabilis*, quite an ornamental, and happily not rare, species of this extensive autumn-flowering genus, is figured in the *Bot. Reg.* for September, t. 1527, and described in the number for October; where Professor Lindley presents the following

Important Information respecting the Genus Aster. “It is well known that the genus *Aster* has long been the disgrace of botanists; that there is no instance, in the whole range of natural history, of such imperfect descriptions, unscientific arrangements, false species, confused synonymes, and multiplied names, as this genus presents. We have for many years been collecting materials, in the hope of being able to reduce it to better order; and lately we have begun to explain our ideas upon the subject, in several articles that have appeared in the *Botanical Register*.

“But we are fortunately relieved from the prosecution of our undertaking, by the appearance of a work from the pen of the learned Dr. Nees von Esenbeck, which, whether we regard the elegance of its style, the precision of its arrangement, the philosophical spirit that pervades every page, or the laborious accuracy with which the whole has been digested, is certainly the most remarkable instance of scientific research applied to systematic botany that we are acquainted with. Our labour in future will be reduced to an illustration of this extraordinary production, or to a criticism of such points in it as may appear to admit of improvement.”

*2337a *EURYBIA* *Cass.* (*Eurubiēs*, wide-spreading, as are its creeping offsets.)
 {corymbōsa *Cass.* corymbed $\text{¥} \Delta$ or 2 au.s W N.Amer. 1765. D co Bot. reg. 1532
Aster corymbōsus *Ait. Hort. Kew. Willd. Sp. Pl.*, and probably of *Hort. Brit.*, No. 23166. *A. cordifolius* *Mx.*, not of *Nut.*

A very common plant in gardens, where each corymb usually consists of numerous heads of flowers; although, in shady woods from Canada to Virginia, where the plant is native, each stem does not usually bear more than from two to ten flower heads. (*Bot. Reg.*, Oct.)

CXCV. *Asclepiadææ*.

*774a *PHYSIANTHUS* *Mart.* (*Phusa*, a bladder, *anthos*, a flower; corolla inflated at its base.)

5. 2. *Asclepiadææ* Sp. 1. —
 álbens *Mart.* whitish-*lvd.* $\text{¥} \square$ or 20 au W Bu. *Ayr.* 1830. S 1 p. *Mart. br.* 54. t. 32

“Seeds of this fine plant were received by Mr. Neill, from Mr. Tweedie, Buenos Ayres, in 1830; and, climbing along the roof of the stove in his garden, flowered freely in August last. I possess from Mr. Tweedie an excellent specimen, in no respect different from the cultivated plant.” (*Dr. Graham*, in *Edinburgh New Philosophical Journal.*)

This is an interesting stove climber, of rather rapid growth, and is in the collection of Messrs. Young, Epsom, as well as in that of Mr. Neill, at Canonmills. The leaves are petioled, opposite, oblong, and deep green and pruinose above. The corolla is salver-shaped; pale rose-coloured when in bud, afterwards white; smooth, somewhat fleshy, and faintly perfumed: its tube is half an inch long, the limb $1\frac{1}{4}$ in. across: the flowers are borne in subdichotomous cymes.

Caralluma fimbriata is figured in the *Botanical Cabinet* of Messrs. Lodiges for November, t. 1863. We mention this, that every cultivator of stapelias may know where to apply for a plant of this highly curious species.

CCXI. *Scrophularinææ*. § Two anther-bearing stamens.

65. CALCEOLA'RIA. [2.s.162
 578c *Martineauæ* *Swt.* *Martineau's* $\text{¥} \Delta$ or 1 ap.au Yspot. *Fotherg.-corym.* 1831. D lt.r.m Sw.f.g.

“This elegant [and ornamental] freely flowering plant is the offspring of *C. Fothergillii* fertilised by *C. corymbōsa*, and was raised by Mr. Blair, gardener to John Martineau, Esq., at Stamford Hill. It has been named

in compliment to Miss Martineau, a young lady of great botanical taste. Drawn at Mr. Low's nursery, Upper Clapton." (*Flower-Garden*, Oct.) This hybrid has already been noticed in this Magazine, Vol. VII. p. 510., and Vol. VIII. p. 48.

28701a *Atkinsiana* D. Don Atkins's $\text{♀} \Delta$ or $1\frac{1}{2}$ ju.o Y.R Eng.hyb. 1830. D p Sw.fl.gar.2.s.168

A short notice of this hybrid is presented, p. 473: it was raised by Mr. James Atkins, Nurseryman, Northampton, between *C. corymbosa* and *C. arachnoidea*. It emulates *C. Youngii*. It is perennial, multipliable by parting only, and was quite unhurt out of doors by last year's winter. "Mr. Atkins finds that peat suits it best, and states that the original plant, which is placed in a border of that soil, is 5 ft. in circumference; and sent forth, in the course of 1832, upwards of 150 stems, each bearing from 30 to 70 flowers. (*Sweet's Flower-Garden*, Nov.)

CCXXI. *Labiatae*. *Scutellaria macrantha* Vis. is figured in Loddiges's *Bot. Cab.* for November, t. 1865., and seems a very desirable species for the hardy flower-border. Its shoots are terminated by a spike of several rather large bright blue blossoms.

MONOCOTYLEDONOUS PLANTS.

CCXXXIV. *Bromeliaceae*.

951a *E'CHMEA* Lindl. (*Aichmē*, a point; from the rigid points on the calyx.) 6. 1. sp. [3186
Mertensii Schult. Mertens's $\text{♀} \Delta$ or $1\frac{1}{2}$ nr.ap G.R Demerara 1830? Sk p.r.w Bot. mag.

A beautiful bromeliaceous plant, sent (when is not stated), with many other rarities, to the Liverpool Botanic Garden, from Demerara, where it is an epiphyte upon trees, by C. S. Parker, Esq. "Its noble yellow green spikes, nearly 1 ft. long, tipped with richly coloured (bright and deep rose red), erect, protruded portions of the petals, and the large red bractees at the base, render this plant a most desirable inmate of the stove." (*Bot. Mag.*, Oct.)

CCXXXVIII. *Amaryllidaceae*.

*933a *CORBULARIA* Sal. (*Corbula*, a little basket; shape of nectary.) 6. 1. 10 sp.
7583. *serotina* Haw. late-flowering $\text{♂} \Delta$ or $\frac{1}{2}$ nr.ap Y Portugal 1629. O s.1 Sw.fl.gar.2.s.164

This is the hoop-petticoat narcissus (*Narcissus Bulbocodium*) of the *Botanical Mag.*, t. 88. but not the *N. Bulbocodium* of Linnæus's *Herbarium*. It is, as is well known, a very interesting and ornamental species.

"The corbularias, being chiefly natives of the south of Europe, require a very slight protection in severe winters: they thrive best in a light loamy soil and a sheltered situation; but also succeed well in pots, if treated as bulbous frame plants. *C. serotina*, if occasionally transplanted when the bulbs are quiescent, succeeds also in the open ground." (*Flower-Garden*, Oct.) I have witnessed its thriving thoroughly, and blooming every year satisfactorily, at the foot of a tall eastern-angled wall. — *J. D.*

979. *ALSTHEMERIA*.
oculata B. C. eyed-flwd. $\text{♀} \Delta$ or 5 ju ll.o. eye. P Valparaiso 1831. O p.1.dung Bot.cab. 1851

"This appears to be a species hitherto unknown: it is one of the climbing kinds; and its flowers, like those of all the genus, are beautiful. We have reason to believe that it will endure the climate of this country, as many of the other kinds do, planted in a border close to the front wall of a stove." (*Bot. Cab.*, Oct.)

Alstræmeria psittacina is figured in the *Botanical Register* for November, t. 1540.; where Professor Lindley, after doubting its being a native of Mexico, as some state, and suggesting that it is rather a native of Brazil or Chile, presents the following admirable remarks on the physiology of leaves: — "Than these alstræmerias no plants evince in a more striking manner the aptitude of one vegetable organ to adapt itself to the functions of another. The breathing-pores of leaves, or stomata (as botanists name them), are usually placed upon their under side, which has also much more prominent veins than the upper, and is covered with hairs exclusively, if

hairs are found upon only one of the two surfaces. In *Alstrœmèria*, the leaves, owing to some unknown cause, are always resupinate; that is to say, in consequence of a twist of their petiole, that side which is born uppermost is turned undermost. Now, it is very curious that the surface, which, under other circumstances, would have no breathing-pores, no hairs, and not elevated veins, acquires all these characters in consequence of having to perform functions that are foreign to it; while the other surface, in like manner, loses them."

CXXXIX. *Iridææ*.

145. *SISYRINCHIUM*.

28017a *maculatum* Hook. spot-petaled £ Δ| or 1 my Y.spot Chile 1831. D l.p. Bot. mag. 3197

This is an interesting species, and seems prolific in flowers. The spathes have a broad white membranaceous margin. The flowers are starry, almost as large as a shilling, of a full deep yellow; but each of the six segments has a deep blood-red spot near its base, and the three inner segments have also a large horseshoe-shaped spot or cloud of the same hue at the tip, occupying the segment's whole width. It is nearly allied to *S. graminifolium*, but is sufficiently distinct. (*Bot. Mag.*, Nov.)

1353a *lutescens* B.C. yellowish-ld. £ Δ| or 2½ my. in Ysh Chile 1830. S lt.I Bot.cab. 1870

Messrs. Loddiges "raised this from seeds sent by Mr. Cuming. It grew to the height of nearly 3 ft., and flowered in the green-house in April and May. It should be potted in light loam; and is likely to be nearly or quite hardy with us. It increases itself by offsets from the roots. (*Bot. Cab.*, Nov.) The figure much reminds us of *S. striatum*.

CCXL. *Orchidææ* § *Vandææ*.

2523. *CYMBIDIUM*. § 4. *Bolbidium*. Rhizoma creeping, bearing pseudo-bulbs from 1 to 3-leaved. *marginatum* Lindl. red-edg.-sepal £ Δ| or ¾ n Y Rio Jan. 1829. D p.r.w Bot. reg. 1530
 " ? *Maxillaria grácilis* Bot. Cab., 1837. [*and Gard. Mag.*, vol. viii. p. 603. 606.] is either this in a sickly state, or a nearly allied species." (*Lindley* in Bot. reg. 1530.)

An air plant, which does not often flower; the sepals are 1 in. long, and yellow, margined with red. Young plants may be obtained by dividing the creeping stem, when the pseudo-bulbs will establish for themselves an independent life by means of their little white and green roots. (*Bot. Reg.*, Oct.)

2524. *CIRRHÆA* Lindl.

(*Cirrhus*, a tendril; form of *rostellum*.)

22642. *Loddigèsii* Lindl. Loddiges's £ Δ| or ¾ jl.au Y.spot Brazil 1822. D p.r.w Bot. reg. 1538
Cymbidium dependens Lodd. Bot. Cab. 936. *Cirrhæa dependens* Loudon's Hort. Brit. p. 370., Sweet's Hort. Brit. p. 488.

The genus *Cirrhæa* differs from all the genera in the tribe *Vandææ* by its stigma occupying the apex, and not the face, of the column; while its anther is situated at the back. In this last respect it agrees with *Notylia*, which is, however, otherwise distinct. C. *Loddigèsii* grows tolerably well in vegetable mould, if placed where the air is humid and the drainage complete; and, in such situations, flowers in August. Professor Lindley also refers to this genus the *Gongora viridi-purpurea* of Hooker; and describes a third species, specimens and a picture of which exist in Dr. Hooker's herbarium, and names it *C. fúscò-lútea*. As, however, this is probably not yet in the country, we must at present only tabulate the second.

92642a *viridi-purpurea* Lindl. green and pur. £ Δ| or 1 jn.au G.P Brazil 1827. D p.r.w Bot. reg.
Gongora viridi-purpurea Hooker in Bot. mag. 2978.

2540. *ONCIDIUM* (*Ogkos*, a tumour; the labellum of every species bears at its base warts, tumours, or other excrescences. *Lindley*.)

cornigerum Lindl. horn-bearing £ Δ| or ¾ au Y.spot Brazil 1829. D p.r.w Bot. reg. 1542

Probably this species exists in no British collection but that of the Horticultural Society, and that of the Rev. and Hon. W. Herbert. It is, "perhaps, the smallest of all the species of *Oncidium* properly so called. The truncated callosity of the crest, with a sort of two-horned screen at its back, and the two lateral erect lobes of the lip at its side, are, when viewed in profile, not very unlike a bull's head in miniature." (*Bot. Reg.*, Nov.)

crispum B.C. curled-petaled $\text{£} \square$ or 3 jn Taw.y.spot Brazil 1831. D p.r.w Bot. cab. 1854

This has been lately introduced; and, in June, 1832, flowered with us for the first time. The flowers are elegant in form, and of an unusual colour: like the other species, it will on occasion increase by separating its pseudo-bulb-bearing root-shoots. (*Bot. Cab.*, Oct.) The flowers in the figure are 2 in. in diameter.

*3412. STANHOPEA Hook.

28530a ebúrnea Lindl. ivory-tipped $\text{£} \square$ or $\frac{1}{2}$ jl W.P Rio Jan. 1828? D p.r.w Bot. reg. 1529

A noble epiphyte, figured from Knypersley Hall, near Congleton, Cheshire. It was imported from Rio Janeiro by Messrs. Loddiges. "The flowers were slightly fragrant, and of short duration; the lip, when fresh, appeared to be formed of the most pure and highly polished ivory." Professor Lindley, in this article, cancels his generic title *Ceratochilus*, because, in applying it to the plants mentioned below, he did not advert to the existence of the same name in Dr. Blume's *Observations upon Java Plants*. Blume's genus appears to be distinct; and it has, therefore, become necessary to adopt Dr. Hooker's name, *Stanhopea*. Professor Lindley, on this point, thus honourably expresses himself:—"We the more readily do this now, because, on a former occasion, in objecting to the reception of the name *Stanhopea*, we suffered ourselves to be betrayed into unkind expressions, which should not have been applied to any one, and least of all to so amiable and excellent a man as our long-tried friend the Professor of Botany at Glasgow." (*Bot. Reg.*, Oct.)

This revision of the nomenclature appertaining to this family of plants renders necessary the obliteration, from *Hortus Britannicus*, p. 489. and 584., of the generic name *Ceratochilus*, and the substitution of the following digest of the species under their new generic title.

*3411. STANHOPEA Hook. (*Earl Stanhope*, President of the Medico-Botanical Society.)

§28531. insignis Hook notable $\text{£} \square$ or 1 jlo P Trinidad 1826. D p.r.w Bot. mag. 2948

Ceratochilus insignis Lindley. Hort. Brit. p. 489. No. 28531.

§28530. grandiflora Lindl large-flowered $\text{£} \square$ or 1 jlo P Trinidad 1824. D p.r.w Bot. cab. 1414

Ceratochilus grandiflorus B.C. Hort. Brit. p. 489. No. 28530.

28530a ebúrnea Lindl. ivory-tipped $\text{£} \square$ or $\frac{1}{2}$ jl W.P Rio Jan. 1828? D p.r.w Bot. reg. 1529

28731. oculata Lindl. eyed $\text{£} \square$ or 1 jn Y.spot Xalapa 1829. D p.r.w Bot. cab. 1764

Ceratochilus oculatus Bot. Cab. 1764. Hort. Brit. No. 18731.

S. ebúrnea "differs decidedly from *S. oculata* and *insignis*; but is, indeed, very closely allied to *S. grandiflora*, from which it thus differs:—Its flowers are not more than two thirds of the size of those of *S. grandiflora*; the horns of the base of the lip proceed from the middle of the margin of the hypochilium, and not from the front of the margin; and the scape in *S. grandiflora* is shorter than the sepals: so that the flowers are erect, while in *S. ebúrnea* the scape is twice as long, and pendulous; and it is a native of Rio Janeiro, while *S. grandiflora* is a native of Trinidad."

NANODES.

(*Nanodés*, pygmy; size of plant.)

20. I. Sp. 2.

discolor Lindl. green and purple $\text{£} \square$ cu $\frac{1}{4}$ au P Rio Jan. 1827. D p.r.w Bot. reg. 1541

"Curious as are very many of the species of epiphytal *Orchideæ*, we do not remember one that is much more remarkable than this, which possesses a habit quite its own. Its flowers are so like the leaves from among which they spring, and by which they are embosomed, that you would scarcely discover the plant to be in flower, even if every branch was blossoming." The plant has been long lost in the Horticultural Society's Garden; and, it appears, is a kind not very easily kept. (*Bot. Reg.*, Nov.)

Orchideæ § *Epidendrea*.

2554. EPIDENDRUM.

22740a virescens B.C. greenish-flwd. $\text{£} \square$ cu $\frac{2}{3}$ jl Gsh Dominica 1829. D p.r.w Bot. cab. 1867

"It approaches *E. fuscatum*; but we consider it sufficiently distinct. The soil should be chiefly moss, with a little sawdust." It is not a splendid species, but one which interests on close examination. (*Bot. Cab.*, Nov.)

CCXLI. *Scitamínceæ*.

8. ALPÍNIA?

magnífica *Boj.* magnificent $\sphericalangle \square$ spl. 10 au R Mauritius 1830. D r.l Bot. mag. 3192

This is a strikingly ornamental plant, and a remarkable member of the order Scitamínceæ. Its leaf-stems are from 10 ft. to 12 ft. high, leafy. Scape or flowering-stem, 5 ft. to 6 ft. high, very stout, leafless, sheathed; the uppermost sheath is dilated, and forms a large, leafy, green bractea; within which is produced the splendid head, or dense spike, of deep purplish red blossoms, 1 in. in length. This spike is rendered the more striking from its numerous bracteas of a fine deep rose-red colour, all margined with a white line, the outer ones exceedingly large and spreading, often reflexed, 3 in. or 4 in. in length; diminishing progressively in size and length to the centre of the spike. This collection of flowers, with the richly coloured bracteæ, soon withers, and is succeeded by a large head of fruit formed of many capsules, each as large as a chestnut; nearly globose, downy, terminated by the withered floral coverings, and intermixed with the equally withered and ragged bracteas.

This superb plant was, a little while ago, only known by dried specimens, and the figure published by Roscoe in his *Scitamínceous Plants*; but roots were, through the medium of Mr. Telford of the Mauritius, introduced by the late Mr. Barclay, and sent to Lord Milton's collection at Wentworth House; where His Lordship's excellent botanical gardener, Mr. Cooper, so treated them as to induce a plant to blossom in the stove in August, 1832. Professor Bojer has suggested the propriety of constituting from this plant a genus distinct from *Alpínia*; and it is probable that this will eventually be done. (*Bot. Mag.*, Nov.)

CCXLVII. *Asphodèleæ*.

*1064a TRICHOPE TALUM *Lindl.* (*Thrix*, *trichos*, hair; *petalon*, a petal: inner series of perianth fringed.) 6. 1. Sp. 1—3.

grácile *Lindl.* slender $\sphericalangle \Delta$ cu 3 jn.au W. Gsh Chile 1828. D r.m Bot. reg. 1535

To judge of the habits of this plant from the branch and leaf figured, *Anthéricum ramòsum* will give a good idea of it. It has fleshy fascicled roots; the stem is sparingly branched (subramose); and from 1 ft. to 3 ft. in height, according to the sterility or richness of the soil. The leaves are glaucous, and linear sword-shaped; the flowers are curious in their fringed petals; the hairs forming this fringe are inserted in a double row, are thick, rough, and composed of short joints. The plant, under good cultivation, flowers and seeds abundantly from June to August. Under this plant, Professor Lindley presents the following remarks on the

Culture of most half-hardy, bulbous, or fleshy-rooted Plants with annual Stems (which we do not present as supplying practical directions to our brother-gardeners, who could doubtless themselves give valuable advice on such points, but because the philosophical theory by which he accounts for practical results are really worth their attention): — "*Trichopétalum grácilis*, like many (perhaps most) half-hardy, bulbous or fleshy-rooted plants with annual stems, succeeds better if committed to the open ground in a frame, or pit which is well drained, has a southern aspect, and from which the frost is entirely excluded. In such a situation, exposed to the open air all summer long, it will form its leaves in perfection, and will not lose them until they have completely fulfilled the purpose for which they are created; namely, the elaborating a supply of food, upon which, in the succeeding year, the new stem will be fed, and by aid of which the flowers will be developed. Plants, under such treatment, if unhealthy when first submitted to it, will probably not indicate any great renovation the first year; but, in the second, the good effects cannot fail to be distinctly perceptible. This is the only way in which Cape roots can generally be cultivated successfully; for few of them are capable of living, or at least of

flourishing, so far north as London, if treated as hardy plants: a fact which, we fear, many who have unfortunately suffered themselves to be persuaded to trust their Cape bulbs to the open borders have discovered to their cost."

The "*Anthéricum* ? *plumosum*" of the *Bot. Mag.*, t. 3084., and of our *Additional Supplement*, No. 28616., is referable to this new genus *Trichopétalum*; and Mr. Lindley judges it to be distinct from *gracile*, "from its narrower leaves, smaller seeds, and erect flowers; with spreading, not reflexed, petals: characters which exist equally in the wild and cultivated specimens. It may be called *Trichopétalum stellatum*." Pursuant to this warranty, we shall give again its tabular details under its new name.

stellatum Lindl. starry-flwd. $\frac{3}{4}$ Δ cu 1 ap W Chile 1829. D co Bot. mag. 3084
Anthéricum ? *plumosum* Bot. mag. 3084., and Hort. Brit. 580., and possibly of Ruiz and Pavon.

CCLI. *Liliæcæ*.

1008. FU'NKIA.

8218a *Sieboldtiæna* Dens. Siebold's $\frac{3}{4}$ Δ or 1 jn Li Japan 1830. D r.1 Bot. cab. 1869
Hemerozállis Sieboldtiæna B. C.

Introduced, by the botanist whose name it bears, to the Leyden garden, whence Messrs. Loddiges obtained it in 1830. It grows freely, flowers in June, and is probably hardy. (*Bot. Cab.*, Nov.)

ART. II. *Retrospective Criticism.*

PROFESSOR Lindley's Publications.—Sir, As the author and compiler of several of the most popular works on gardening in our language, it may be presumed that your opinions and advice tend, in a greater degree than, perhaps, those of any other man, to influence the conduct and habits of the younger members of that profession, the interests of which you profess to advocate.

As an occasional reader of the *Gardener's Magazine*, I am happy to bear testimony to the candid and impartial manner in which this responsible task is generally performed; yet I have seen and regretted some few instances wherein the frailty natural to humanity has manifested itself, and private friendship or interest, perhaps pique, has superseded justice.

These observations are induced by the high encomiums bestowed, in the *Gardener's Magazine*, on Mr. Lindley's recent publications, the *Principles of Botany*, and the *Outline of the First Principles of Horticulture*; encomiums which, I cannot but think, are in a great measure unjustifiable. Undoubtedly, very great credit is due to Mr. Lindley, for having condensed within the limits of his two small books more really useful information than is to be sifted from among the baseless theories, oft retailed experiments, and conflicting opinions, that cumber the pages of many of the ample and costly volumes given to the world for its enlightenment, by men with half a score learned abbreviations tacked to their names. But the unqualified praise so lavishly showered both upon the author and books, naturally inclines those who purchase the works to expect something very nearly approaching to perfection. Such, at least, was the case with me; and my disappointment was proportionately great, when, on comparing the two works, I found that propositions laid down in the *Principles of Botany* as *essential principles*, are, in the later publication, directly contradicted. That Mr. Lindley, for his credit's sake, may have an opportunity of correcting such palpable blunders, I have transcribed such of them as have occurred to me; and, as an act of justice to those among your readers who, like myself, have procured the books on the recommendation contained in this Magazine, you will take the earliest opportunity of making public my remarks through the same channel.

In the *Principles of Botany*, paragraph 25., it is said that spiral vessels "are not found in any part which is formed in a downward direction, and are, consequently, absent from the wood, bark, and root."

In the *Principles of Horticulture*, par. 15., we are told that "spiral vessels are not found in the wood or bark, and rarely in the roots of plants."

The former of these paragraphs lays down, as a *positive rule*, that spiral vessels do not exist in the parts of plants which are formed in a downward direction, and, as a consequence, that they are absent from the wood, bark, and root. In the latter, it is said that spiral vessels are *rarely* found in the roots. If they are *ever* found in these organs, does it not follow that the *principle* which we are taught by the first paragraph is false?

Principles of Botany, par. 25., "The function of the spiral vessels is unknown.

33. Their functions (those of the ducts) have not been accurately determined. It is probable that they serve for the passage of air.

86. The medullary sheath consists of spiral vessels and ducts.

89. It carries upwards the fluid absorbed either immediately from the earth, or through the intervention of the alburnum, and conducts it into the leaves."

There appears to be a little "mystification" here. If the function of the spiral vessels is unknown, and those of the ducts uncertain, how can it be said that the spiral vessels and ducts, of which, as we are told, the medullary sheath is composed, carry upwards fluid to the leaves? Again, to make the matter clearer, it is stated in the

Principles of Horticulture, par. 21., that "Spiral vessels convey oxygenated air."

Principles of Botany, par. 200., "The food of plants consists of water holding various substances in solution. The roots have the power of separating these substances, and selecting such only as are congenial to the nature of the species."

Principles of Horticulture, par. 37., "These organs (the spongioles) have no power of selecting their food, but will absorb whatever the earth or air may contain which is sufficiently fluid to pass through the sides of their tissue."

Will the learned professor reconcile these two principles? Other discrepancies might be pointed out in these two works, especially in the passages relating to the excreting theory, against which it would be easy to adduce evidence that would shake it to the very foundation. But enough has been said to show the possibility of even such men as the learned professor overreaching themselves, and also to justify my remark, that your unqualified praises were, to say the least, premature. I am, Sir, yours, &c.
— *A Journeyman Gardener*. Nov. 1. 1832.

We thank our correspondent for his strictures, and invite him to continue them whenever he sees occasion. — *Cond.*

Shalder's Fountain Pump. — As we strongly recommended this pump (Vol. VII. p. 218.), we consider it right to lay before our readers the essence of a paper, which we have received from our correspondent Mr. Mallet of Dublin, on the subject. It appears that the person who has purchased the patent right of this pump was endeavouring to sell that right for Ireland to Mr. Mallet, who was disposed to purchase it, but who, being rather surprised at the seller coming down very greatly in price, thought of examining the records, and found, on consulting them, that there was no patent for Shalder's pump, for Ireland, at all. Having detected this attempt at imposition, he next thought of enquiring whether the invention was a new one; and he found it described in Belidor's *Architecture Hydraulique*, tom. ii. liv. iii. chap. iii. p. 120.; and something very similar in

Gregory's Mechanics, vol. ii.; and in *Nicholson's Operative Mechanic*. We have sent Mr. Mallet's letter to the editor of the *Mechanics' Magazine*, in which it will be found, vol. xviii. p. 70. Mr. Mallet remarks that this is an instance of what has become common in London of late years, "the practice of furbishing up an old invention, and taking out a patent for it, either through ignorance, or a worse intention." — *Cond.*

Trafficking in Gardeners' Situations. (p. 499.) — From what has come to my own knowledge within the last twelve months, I can fully add my testimony to the truth of the remarks of An Enemy to Bribery. I do not think it necessary here to enter into a full disclosure of the transactions above mentioned, but merely to say, that, however surprising the coincidence may seem, the same letters of the alphabet will answer very well for the name and abode of the individual to whom I allude, as those that designate the worthy trafficker noticed in your former pages, viz., a Mr. B. of Y. I remain, Sir, yours, &c. — *An Advocate for every Thing being done above board.* August 28. 1832.

Trafficking in Gardeners' Situations. (p. 499.) — Sir, I beg to inform An Enemy to Bribery (p. 499.) that I have enquired, and cannot hear that any thing of the kind he alludes to has been transacted in this part of the country. I can hear of gardeners having been recommended by a nurseryman, and they, of course, feel themselves under an obligation to send to the nurseryman for what seeds and plants they may want; but this is nothing but what is right, as it is discharging an obligation, and of no injury whatever to their employers. An Enemy to Bribery believes the practice of trafficking, which he describes, to be detrimental to gardens and gardeners. This cannot be the case, as the absurd practice of Mr. B. of Y. is far from being a general one; and a good honest gardener is not so great a blockhead as to give twenty pounds for a situation; and an inexperienced gardener would very soon lose the situation he had paid so dearly for. The statement of An Enemy to Bribery is thought by many to be little less than enmity or jealousy on his part, or else the names of all parties would have been published in full, in an open and Englishman-like style, a system which it would be well if many of the correspondents of the Magazine adopted. I have purchased the Magazine for the last three years, and have frequently read experiments, proved by whom we know not, except by two and sometimes three capital letters of the alphabet. I am, Sir, yours, &c. — *William Whidden, Gardener to Colonel Chester. Chichester, near Newport, Bucks, Sept. 10. 1832.*

Mr. Hay's Method of heating by Steam. (p. 330.) — Sir, I have perused with very great pleasure Mr. Hay's plan and description of heating hot-houses by steam through perforated pipes; a plan which, I have no doubt whatever, when the nature and principles of steam, as applied to the heating of hot-houses, pits, &c., become better known, and the mania for hot water has a little subsided, will, for horticultural purposes of every description where artificial heat is required, be found superior to any other hitherto invented. The country being just now pretty full of hot water, I expect some will be inclined to consider such an assertion rather speculative; which, to a certain extent, I must admit, though I believe it has been found to answer perfectly in several places where it has been tried, and the time which it has been in use here induces me to speak at least from short experience. About two years ago, I had two vineries built, to supply early grapes, with the borders laid hollow, and perforated lead pipes introduced underneath, with the view of maintaining a temperature in the outer border, during the forcing season, equal to that of the surface of the earth during the months of July and August. The vines being young, and not having yet been forced, I am only able to state that the temperature of the border can be regulated to the greatest nicety. Early this spring I had a cucumber pit

built, and heated in the manner alluded to, which I find to answer most completely; and I have since obtained permission to build as many more as may be required for melons, cucumbers, asparagus, sea kale, &c., and to heat the whole in the same way.

A melon ground heated on this principle will, I think, be found to possess many advantages over the one in general use. The most obvious of these will be, the order and neatness which can at all times be maintained in this department. Instead of wading up to the knees in litter, to get near the pits, which is often unavoidably the case in the early forcing of cucumbers and melons with fermenting dung, there may be clean flag-stones or gravel to walk upon. I have lately had a pine-stove heated on the same principle, but have not yet tried it a sufficient time to enable me to offer any remarks, beyond merely stating that I can at pleasure raise or lower the temperature of the bark bed with the greatest ease; an advantage, by the by, which will be only apparent to the pine-grower. Having extended my remarks thus far, I beg leave to advert to one very important improvement which may be contemplated from this mode of heating; namely, the facilities which it affords for getting rid entirely of the hideous black chimney-tops that disfigure so many gardens with their dense volumes of smoke, which they are every now and then sending forth during the whole of the winter and spring months; a nuisance, in garden scenery, which nothing but necessity and habit could have made at all tolerable. Only one chimney-top would be required in the largest forcing-establishment; and, presuming that Witty's patent furnace answered the purpose for which it is so highly recommended, even in this solitary chimney there would seldom be any smoke. I may, at some future time, be able to add a few more remarks on this subject, should you think them worth your acceptance. — *Robert Marnock. Bretton Hall Gardens, July 14. 1832.*

A Method of transplanting large Trees is mentioned by Edw. Jesse, Esq., deputy surveyor of His Majesty's parks, in his amusing *Gleanings of Natural History*, p. 309—313., who states that it has been attended with "great success," and, he believes, "will be found infinitely cheaper, and more generally to be depended on, than the plan of Sir H. Steuart. . . . Of some hundreds of trees which were taken up and replanted in Bushy Park, in March, 1831, not one had died [up to what period Mr. Jesse does not state, but his book was published in March, 1832], though many of them were of a large size, and some of them laurels from 10 to 12 ft. in height, showing their blossoms at the time they were transplanted, which was not at all checked by the operation." Mr. Jesse's plan is, to "excavate the earth at some distance from the tree, leaving all the principal fibres, and the earth adhering to them, in a compact ball, undermining it as much as possible, and taking care not to shake or injure the ball, by twisting the stem of the tree, or using it as a lever to loosen the tap roots." These deeds performed, and a hole prepared to receive the tree, to effect its removal the following are the apparatus and process: — "Two pieces of iron must have been previously formed, of the breadth and thickness of a common cart-wheel tire, 3 in. or 4 in. wide, and rather more than half an inch in thickness, and about 6 ft. long, bent as in *fig. 151. c*, which will reduce it to 3 ft. across. This size will do for trees requiring from two to four men to lift them; but a size larger, and stronger in proportion, will be wanted for trees that will require from eight to ten men, or more, to carry them. Put these irons under the ball of earth, as near the centre as possible, leaving a space between them of about 2 ft., and for larger trees a little more. Take two strong poles, about 8 ft. or 10 ft. long, and 3 in. or 4 in. in diameter, and smaller at each end, and apply them as shown in the sketch (*a*), to each side, passing them through the bends of the irons, so as to form a complete handbarrow. The tree may then be readily lifted

151

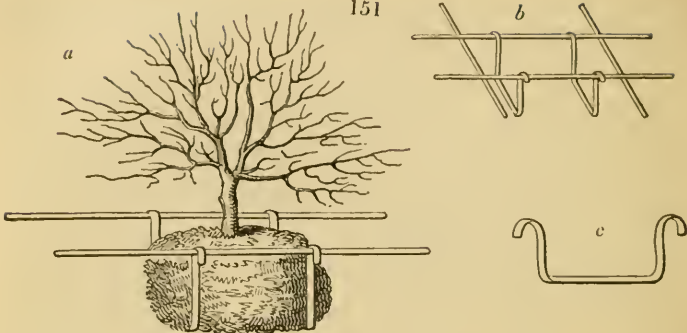

Cross levers may be used for larger trees which require more men (*b*), so that as many men can conveniently apply their strength to it as are wanted, without being in each other's way. The whole is fixed and unfixed without any loss of time, and requires no tying, nor is there any danger of its slipping off." Our author recommends that, in digging out the trench around the tree, a larger ball than is really meant to be removed should be left, which can be reduced with a pick without injuring the roots, and that the tap and other roots inconvenient to get at may be severed under the ball of earth with a long chisel. The best way of forming the ball is to prepare it the year before removal, by digging round the tree, and cutting most of its principal roots. In planting, in either case, spread the projecting roots out carefully in different layers, as near as possible to their original position, as the hole is gradually filled up with mould. "I do not find," says the author, "that trees thus planted require support, as the large ball of earth steadies them sufficiently." He admits, however, that the trees he has removed are not so large as those described by Sir H. Stenart. "Had it, however, been necessary for me to have planted larger trees, I have no doubt but that I should have succeeded equally well; as, by means of the cross levers, the strength of a proportionable number of men may be readily applied."

Mr. Jesse proceeds to give directions and remarks on preparing the ball of trees to be transplanted, and of adjusting their roots, as the hole into which they are transplanted "is gradually filled up with mould." These are very well, but superfluous to gardening readers.

We have two objects in presenting the preceding abstract: one, to illustrate the following strictures on Mr. Jesse's mode, by a practical man; the other, to afford those whom this subject interests an additional invention to those already presented to them in our Vol. V. p. 422., and Vol. VII. p. 29, 30. and 655.; and *Encyclopædia of Gardening*, § 1468.

In reference to the strictures, a correspondent, J. M., in a communication dated "London, May 16. 1832," writes as follows. "Having bought Mr. Jesse's book, I sent the part of it which describes the author's mode of transplanting large trees to a friend of mine, a gentleman who has been extensively engaged in this branch of arboriculture, thinking he might derive some advantageous hints, as I knew he had made some alterations in the machinery, which had received the approbation of Sir Henry Stenart himself; and as your work is designed for the benefit of science, I have thought that the remarks of my friend may be worth a place in it. They are these:— 'I am much obliged to you for the extract on planting trees and shrubs. It is always gratifying to me to read men's opinions upon

matters that I have some little knowledge of; but I must say that this gentleman is shouting before he is fairly out of the wood. From his own observations, I am certain he is no practical planter; but, should I be mistaken on that point, I must say that his ideas are very weak on the subject: but to fancy that he had superseded Sir H. Steuart in transplanting, plainly tells me that he knows nothing about Sir Henry's method of removing large trees. If he were to attempt to remove such trees as Sir Henry Steuart has removed, or as we have removed here, upon the principle he proposes, he would tear this part of his book to pieces, and regret that he ever sent forth such erroneous opinions. If the king his master were to send him as many guards as would repel a regiment of French cuirassiers, should he place them three deep round such trees as we have planted, their united strength could not lift one out of the pit, with his bars, hooks, and poles. All the credit that I can give him for his scheme is, to use it for the removal of a few small shrubs in a pleasure ground. This gentleman should have waited for the year 1835, before he had put his hand to paper on the subject: let him then give his candid opinion, and, I believe, he will then refrain from boasting of his having superseded Sir Henry Steuart."

J. M. speaks of some alterations which his friend has made in the machinery recommended by Sir Henry Steuart. From the circumstance of J. M.'s friend being a practical man, the alterations may be valuable, and we shall be glad to be made acquainted with them. — *J. D.*

Láthyrus grandiflorus. (p. 50.) — G. C.'s practice of artificially promoting the impregnation of the germens of this plant is ingenious and useful; but, although I have this year applied the experiment repeatedly, and also cross-impregnated flowers of *L. grandiflorus* with the pollen of the white and blue flowered varieties of *L. sativus*, I have altogether obtained but three or four seeds. I had previously flowered several seedlings of *L. grandiflorus*, but these all strictly resembled the original species. Six years ago, I planted a plant of *L. grandiflorus* near to a handsome spruce fir, around which the roots of the *Láthyrus* occupy the soil, and its shoots and blossoms are annually blended with the branches of the fir into a conical mass, surmounted by the spiry top of the fir, and producing a most pleasing effect; the *Láthyrus* having climbed, by means of its tendrils, to the height of ten feet. — *Wm. Godsall. Hereford, Sept. 29. 1832.*

Mr. Pearson on the Cultivation of the Fig, in reply to Mr. Smith. (p. 489.) — Sir, I observe (p. 489.) a most unjust attack on me in regard to the culture of the fig, by one who calls himself John Smith, journeyman gardener: and, truly, I think, he is a journeyman in more respects than one; nay, even an apprentice. Permit me, then, to say a few words in answer to this journeyman near Hexham, or some other place. He sets out by endeavouring to make me the author of the epithets "sluggish and ignorant," as applied to gardeners: now, it is unfortunate for him that he should have left school before he was taught the use of inverted commas, and also that of reading with attention and understanding; for I deny being the author of these epithets in my treatise on figs; but, to set him right, he may read my paper over again, and then refer to the *Spectacle de la Nature*, translated from the original French, by Kelly, Ballamy, and Sparrow, vol. ii. p. 145., and there he will meet with the word sluggish, which I quoted. His laundry phrase of washing without soap is only what he "thinks;" therefore it gives me no concern whatever. He says, my "method of pruning is simple enough." True, it is; and so is every other branch of the science when once it is learned: but let me tell John Smith, that every "cabbage gardener" has not yet learned to prune a fig tree; and, for any information which he has given, they may still remain in ignorance. He says, he would prune fig trees in April, after his

covering of fern or spruce was removed: and for what reason? just that he might know the fruitful from the unfruitful branch. Certainly this is a good advice to a "cabbage gardener," who knows no better: but it so happens that I know the difference in the end of autumn; hence I am enabled to prune, and nail, and cover up at the same time, by which the young shoots, and the autumn-shown fruit are better protected than they would otherwise be in an unnailed state. Moreover, it is a most unnatural thing to begin to prune a fig tree at the very time when the sap is in active operation, and the newly projected fruit running the hazard of being rubbed off during the process of nailing, &c.

John Smith farther says that I have taken no notice of the management of figs in hot-houses. This, it would appear, I had left for him to do, and a poor job he has made of it. He says that fig trees in hot-houses do not retain their fruit on last year's wood, but that they all drop off, and only ripen their fruit on wood made the same year. This I deny; for on fig trees in hot-houses, under good management, there are always a first and a second crop. The second one is, in general, better than the first. That some of the first crop do drop off I do not deny, but not all, as J. Smith would have it. Where they are kept in houses, they should be planted in boxes, in a black lightish loam, pretty rich, and well supplied with water, under the temperature of 55° or 60°; and, in regard to pruning, they should be kept thin and regular. But to return: John Smith says that I contradict myself, by saying, first, that the fig is an aquatic, and then, that I lost a crop in a wet season. True, I said so much; but did I not give the reason for it? J. Smith must be more careful in future in regard to his reading and writing; which is the best advice I can give him. But he goes farther, on mere supposition, and says that the trees at "Ormiston Hall are 100 years old." I admit that some of them are old; and the wall against which they are placed is not very young; yet they are not altogether destitute of a modern appearance; neither is the soil in which they grow so completely exhausted as he so gratuitously imagines. He is also presumptuous enough to think that I have no young fig trees under my management: but in this also he is mistaken; for I have young trees, not of "ten," but of four years' standing; and these are making wood like their aged neighbours; not that short, stunted, spurlike stuff that he speaks about, but shoots from 18 in. to 2 ft. long; ay, and fruit on them too, three of which weighed 13 oz. imperial this very day. Will John Smith believe that? Now, Sir, I have done with J. Smith, and leave it to the candour of your readers to estimate the validity of his attack on my *Treatise*. I present my thanks to J. D., for his interesting and pertinent account of the fig tree at Hardwicke House, near Bury St. Edmunds.

Now, Sir, to have done with figs, I have just one word more to offer. In a private letter which I, long since, had the honour to receive from you, you remarked that you had seen, in the south of France and in Italy, fig trees growing in the clefts of rocks, which gave the idea of a dry situation. Now, you will readily admit that rocks and mountains are more the receptacles of rain than the valleys below, and that they give out water to supply the springs even in the time of severe drought. In the open joints of rock, where tree roots are able to penetrate, is generally to be found a great deal of moisture; which leads me to think that trees so situated are better watered than those growing in a cultivated soil. I remain, Sir, yours, &c.—*William Pearson. Ormiston Hall Gardens, Sept. 19. 1832.*

In the *Scotsman's* report (Sept. 8.) of the exhibition of fruits of the Caledonian Horticultural Society, on Sept. 5., this remark occurs:—"From the garden at Balmuto were sent some large and ripe specimens of Black Ischia fig, with useful practical remarks on the management of the

fig tree as to soil and situation, by Mr. James M'Culloch, gardener to Mrs. Boswell. Thanks were voted, with a copy of the last published part of the Society's *Memoirs*." This remark is quoted to induce to Mr. Pearson and Mr. M'Culloch the, possibly mutual, benefit and pleasure of each other's correspondence on that interesting subject the culture of figs. What fruit so luscious as a perfectly ripened fig fresh off the tree! The notice of the thorough thriving of *Ficus stipulata* under a liberal supply of water, to which we alluded in p. 490., occurs in the present Number, p. 689. — J. D.

ART. III. *Queries and Answers.*

TECHNICAL Terms in Horticultural Chemistry. — Sir, I wish some of your learned correspondents would insert in the Gardener's Magazine a list of the chemical terms relating to horticulture, which are not to be found in an English dictionary, and with their proper accentuation. Such a contribution would be beneficial to those of your readers who, like myself, know little or nothing of the learned languages. I would also ask, *What is the simplest test for detecting the oxide of iron in soils and subsoils?* I am of opinion that a clayey subsoil, containing oxide of iron, is one cause of the canker in fruit trees; and also the cause of what is here termed the cancer in the Scotch pine. I have never seen a blown-down cancered tree of this kind, but what had the greater part of its roots rotten, and which had partly penetrated into such a subsoil. I am, Sir, yours, &c. — Wm. Taylor. *Aberdeenshire, July, 1831.*

Uses of the Red Spider. (Vol. VII. p. 218.; Vol. VIII. p. 499.) — J. D. asks (p. 499), "Has not Mr. Godsall confounded two very distinct insects," under the name of the red spider? In my communication (Vol. VII. p. 218.) I stated, "I have heard them" (the crimson velvet insects) "*stigmatised* as red spiders:" also, "I know *not* whether this insect belongs to the genus *A'carus* or not." I think J. D. might have concluded from the above passages that I ridiculed the idea of confounding them, and, of course, endeavoured not to do so myself; although, in the sentence, "since then I have frequently found the *A'cari*," &c., it should, instead of "*A'cari*," have been crimson insect, perhaps, which I almost think was the case in my letter. — Wm. Godsall. *Hereford, Sept. 29. 1832.*

What is the Mode of dissolving Caoutchouc (Indian Rubber) in Pyrolignous Ether, and where is Pyrolignous Ether to be readily obtained? — Sir, Your correspondent, Mr. Mallet, has (at p. 554.) recommended a varnish of caoutchouc [Indian rubber] dissolved in pyrolignous ether as equally cheap and durable for horticultural purposes; but he has unhappily omitted to describe, for the information of the less informed, the best mode of effecting the solution of the caoutchouc in the ether, the time required to effect it, or the price of the pyrolignous ether, which is not, I believe, to be commonly met with in the druggists' shops, not being yet in sufficient demand. By supplying this information he will confer a material obligation on many of your readers, and upon me among the number; and enable many to avail themselves of his advice, who may otherwise be prevented from adopting it. Having occasion to varnish an elastic tube, I prepared a solution of caoutchouc in the essential oil, or spirit, as it is familiarly termed, of turpentine; but I found the process of solution tedious and troublesome, and, when effected, the liquid proved viscid, and slow in evaporation; an inconvenience of which I know not how to get rid. Possibly, the solution in the pyrolignous ether, if I knew where to procure it, might be effected with more ease, and be free from the objections to which the terebinthine solution is subject. — Wm. Hamilton, M.D. 15. Oxford Place, Plymouth, Oct. 4. 1832.

Of the Otaheitean Arrow-root (Tácea pinnatifida L.), what Proportion does the Fecula yielded bear to the Weight of Tubers from which it is derived? and what is the Relation of the Weight of Tubers to the superficial Quantity of Soil producing that Weight? — Your correspondent, Mr. Mathews of Lima, has furnished (p. 585.) a most valuable communication on the fecula afforded by the roots of the *Tácea pinnatifida*, and the mode by which it is separated from them by the inhabitants of Otaheite. To this information if he could furnish a statement of the proportion of fecula obtainable from any given weight of the washed roots, and the probable weight of roots obtainable as a crop from an acre or any other given quantity of ground, he would confer an obligation on such of your readers as reside in countries adapted to the cultivation of this esculent. Its introduction into our West Indian Islands, by increasing the amount of human food produced within them, would perhaps be attended with much advantage to the inhabitants, both as a source of domestic supply and of profitable exportation; and if any of your readers should possess a sufficient share of philanthropy to furnish me (under a frank) with a few of the seeds, it will afford me much pleasure to distribute them among my correspondents in the West Indies, accompanied by any information respecting their culture, &c., which the donor may feel disposed to transmit to me along with them. — *Wm. Hamilton, M.D. Oxford Place, Plymouth, Oct. 15. 1832.*

How can Plants of the Genus Citrus be prevented shedding their Leaves and young Fruits? — I should be much gratified if any cultivators of the genus *Citrus* would inform me of a method to prevent the plants shedding their leaves and fruit on being removed from a green-house to another situation. This last season I removed three large plants from a green-house to a light airy room, of very similar temperature, and the door of which was almost constantly kept open, as was that of the green-house. Notwithstanding this parity in the condition of the plants, they lost many of their leaves and all their small fruit. — *I. J. Oct. 13. 1832.*

The Corolla of Calystègia sepium Brown closes in a different Manner from that in which the Corolla of Ipomœa purpurea Lamarck closes: is there any Difference of Structure to account for this? — In my garden, *Calystègia sepium* and *Ipomœa purpurea* are growing together, and are twining up the same strings. I have watched them attentively in all their stages of flowering, and have seen with surprise the different manner in which the corollas close when they begin to fade. Those of *Calystègia sepium* close together in longitudinal folds, while the edge of the corollas of *Ipomœa purpurea* curls inwards upon the parts of fructification. Is there any difference in the structure of the corollas, to account for the difference in the manner of their withering? — *John R. Rowe. Wimborne, Sept. 15. 1832.*

The fittest Soil for, and Management of, Auriculas in low Situations. — Sir, I should feel grateful for plain directions as to soil and management requisite for the *Prémula Auricula* in low situations. In Vol. IV. p. 246. you mention Mr. Gray's having written a judicious paper on this subject; but of his mode of treatment no mention is made. It is something of this kind that I am in want of, as I have Hogg's *Treatise on Florist's Flowers*. I am, Sir, yours. — *R. W.*

On preserving Cape Heaths from Mildew. — I should feel greatly obliged to any cultivator of that most beautiful and interesting genus *Erica*, for an explanation of the cause, and instructions for the prevention, of a sort of mildew which sometimes attacks these plants in our green-houses and frames. It frequently destroys a whole set of plants in a very short time. I find no account of it in the last edition of Sweet's *Botanical Cultivator*, nor in M'Nab's *Treatise on Cape Heaths*. I have been informed that suffering water to be poured over their tops will cause it? I hope some experienced cultivator will early advise me on this point. — *R. W.*

Which is the best Plan for a Fruit-room? — Sir, There is one very requisite appendage to a garden, which, notwithstanding all that is written on subjects connected with gardening, seems to have in a great measure escaped observation; I mean, the fruit-room. It may seem strange, but it is nevertheless a fact, that I have never in my life seen a fruit-room that gave me any thing near satisfaction; and it is really somewhat strange that about many splendid gentlemen's seats, where you would suppose invention had been exhausted, they are yet sadly deficient in this particular. I abstain from remark upon any existing fruit-room, and from any suggestions on their improvement; my object being to call the attention of yourself and correspondents to the subject, and I should feel gratified, and possibly so would many others, if you yourself or any of your numerous and able contributors, would so far turn their attention to the subject as to furnish the Gardener's Magazine with some useful information or useful designs. The structure of such a thing as a fruit-room must, of course, in most places, be in some degree modified by local circumstances; but, I confess, were I desired to set about erecting one, I should be very much at fault. I have sometimes hardly known whether to laugh or be sad at seeing, about the offices of splendid mansions, the store fruits of the season huddled away in filthy holes, often over the ceilings of stables, &c., among dust and cobwebs; and in heaps (when blessed with plenty) that would lead a casual observer to believe that speedy decomposition was the object in view, and, with all this (absurdly enough), the poor wight of a gardener is expected to supply the family with well-preserved wholesome fruit. All I can say is, that such things ought not to be; and, if you, Sir, and your coadjutors, will contribute your efforts, I do not despair of seeing a beneficial change in the bestowing of fruits for winter use. I am, Sir, yours, — *J. Hislop. Ashted Park, Aug. 23. 1832.*

A double-flowered Almond Tree. — I have now in flower a double-flowered almond tree, whose blossoms have the appearance of roses. I received the tree from North America, about three years ago. — *M. Saul. Sulyard Street, Lancaster, April 18. 1832.*

The double-flowered peach tree is well known in English collections, but we have not previously heard of the double-flowered almond tree. Calling it emphatically a "tree" renders it impossible that that elegant double-flowered little bush the *Amýgdalus pumila*, or double dwarf almond, can be meant. — *J. D.*

Double Flowers on Kirke's Emperor Apple. — Sir, I have had large double flowers produced on Kirke's Emperor apple. They were produced on the young shoots of this season that had extended to 6 in. from the branch, and were bearing four leaves. The flowers were double, large, 3 in. across, and appeared, at a distance, like large double white roses. They have produced no fruit. Is it common for new young shoots to produce flowers after shooting to the length of 6 in.? Were these double-flowered shoots taken off in the autumn, and ingrafted in the spring, would the double-flowered variety be thenceforth perpetual? — *M. Saul. Lancaster, July 8. 1832.*

A Kind of Beetle destructive of Grape Vines. — Sir, I have a species of beetle which has annoyed me, more or less, since 1809. My attention was then first called to it by having a row of vines, thirty-two in number, planted inside a vinery, totally destroyed by their roots being eaten off by it. It feeds on the root of the vine in winter, and on the young shoots in summer. When feeding on the roots it takes the form and colour of the worm or grub [larva] which we find in filberts; and, previously to feeding on the shoots, assumes the beetle form: I intend to send you specimens in this latter state. I am, Sir, yours, &c. — *W. Z. Sept. 24. 1832.*

We shall receive specimens with pleasure, and will endeavour to get their name ascertained. We suspect the creature is *Circulio vastator*, of whose habits we know something. We request from W. Z. every fact on its habits and history which he can supply. — *J. D.*

What Plant is fitter for the Formation of Hedges than Hawthorn? — This shrub has many faults. It is excessively slow of growth, defective in its resistance of cattle, will not grow from layers, and takes many years to form a perfect fence. Doubtless there are many woody American plants that would do better. Which are they? — *Alexander Checks. July 24. 1832.*

The letter containing this query has for its postmark, Beaumaris, and this indicates a clue, although not an infallible one, to the district in which the hawthorn thrives so imperfectly. I believe that a character quite the reverse will be ascribed to it in Cambridgeshire and Suffolk, and in other loamy-soiled counties, where I have seen it make excellent fences; and this in a few years: in Cambridgeshire, it may be even seen thriving where the fenny soil commences, and where water is always within 24 in. of the surface of the soil. It grows so readily from seeds, and these are produced, in most seasons, so abundantly, that few would think of increasing it by layers. It is, however, readily increasable by cuttings of roots derived from hawthorn plants of some age and size. Queries may be here introduced on the practice of feeding turkeys on haws in Norfolk. Is the practice common? Are the turkeys confined while thus fed? What are the results to the turkeys? and do the nuts of the haws, which have passed through the bodies of the turkeys, germinate more quickly than those which have not? In Cambridgeshire, the practice is to have the haws collected by women and children, at so much a bushel: they, with hooked sticks, pull the branches towards them, and strip off the haws by hand. Quantities of these, from 20 to 40 bushels or more, are buried, about Christmas time, together, in a long narrow pit, where they lie till the beginning of February in the second spring following. They are then taken out to be sown, when it is found that the flesh of the haw has rotted away during its interment, and that the seed is quite ready to rupture the nut: indeed, if allowed to remain in the pit later than the beginning of February, many seeds will be found to have sprouted. I have heard it asserted that haws which have passed through the bodies of turkeys are thereby prepared for germinating with less loss of time than those which are buried. This is scarcely likely to be the case. Is it the case? and, if the case, may not an equal acceleration be effected by subjecting the haws to the action of a hot-bed of moderate heat, to decompose their fleshy part? — *J. D.*

A Fungose Disease on the Leaves and Fruit of the Pear Trees at Buscot Park. — Sir, I enclose a few leaves off my pear trees for your inspection, hoping that from yourself or numerous correspondents I may derive some information which may enable me to remedy this growing evil, which affects the fruit as well as the leaves, and, I believe, will, unless checked or prevented, destroy the trees altogether. I am, Sir, yours, &c. — *J. Merriek. Buscot Park Gardens, Oct. 22. 1832.*

Are the trees declining with age? Are they on a soil of which there is but a thin layer lying upon gravel or some other arid subsoil, which deprives the top soil of too much of its moisture? Are they so situated, as to aspect, as to be early excited into leaf in the spring, before the weather has become universally exciting? In asking these questions, we do not even suggest that, if each of them were answered affirmingly, they could be set down as the causes, although it is just possible they might: so we leave our practical brothers to determine the cause, and prescribe a remedy. The leaves received are hideous objects. Much of their native green

colour is displaced by a dark brown one, betokening the leaf as dead or dying in this part, and within the brown part, on the surface of the leaf, are orangy blotches, and from these blotches, on the under side, protrude softly woody excrescences, from which are projected pale brown teat-like miniature bags, more than a quarter of an inch long, and closed at the mouth. These bags are the peridia of a parasitic species of fungus belonging to the genus *Æcidium*: although, to strictly accord with the characters of this genus, they should have an orifice, usually lacerated, at the tip. In p. 179. of the present Volume will be found (in extracts from the *Memoirs of the Caledonian Horticultural Society*) a very interesting description, by the late Mr. Wm. Don of the Hull Botanic Garden, of the *Æcidium laceratum*, and of the manner in which a hawthorn hedge round the Hull Botanic Garden was infested with it. This pretty species, the *Æcidium laceratum*, we have had the pleasure of seeing this autumn, although but sparingly, on the fruits and foliage of an old hawthorn hedge at Bayswater. This species will be found well figured in the *Encyclopædia of Plants*, p. 1045., No. 16677.

In Mr. Don's account, already referred to, it is incidentally remarked that the "*Æcidium cancellatum* of Sowerby's *English Fungi*, t. 409., attacks pear trees, and often prevents valuable crops." This remark has induced us to submit the specimens, sent by Mr. Merrick, to Mr. J. D. C. Sowerby, who has kindly informed us that they are of the *Æ. cancellatum*, and that it is one of the characteristics of this species, to have the peridia devoid of an orifice at the tip.

Those whom this notice of the genus *Æcidium* may render desirous to know more about it will find twenty species of it described, and some of them figured, in the *Encyclopædia of Plants*, p. 1044—1046.; and in this Magazine there are notices of two or three species, in Vol. III. p. 382. 490, 491., Vol. IV. p. 192., Vol. VII. p. 599., and Vol. VIII. p. 179.

The peridia, or teat-like bags, already spoken of, are seed bags enclosing the seeds, technically called sporidia; and hence it may be, that when the leaves of a tree have become diseased, so as to be eligible soil, as it were, for the seeds or sporidia of the *Æcidium*, that these, on falling on them, may germinate readily, and occasion that numerous and extensive multiplication of the fungus of which Mr. Merrick, with much cause, complains. This idea of *Æcidium* growing from seeds scattered on the surface of diseased leaves scarcely comports with one of the botanical characters of the genus, which is, that the peridium, or seed bag, is formed beneath the epidermis of a leaf, and which it ruptures by its increasing size, and afterwards projects beyond it. If the *Æcidium* is, however, after springing up on a tree, multiplied by its seeds externally scattered, it is a question not unworthy occupying the mind with, whence arose the original plant or plants? They might be conveyed in the air from other districts where this parasitic fungus prevails. But this question is asked, as much for the sake of introducing the following speculation as for any other purpose: it is offered by a distinguished contributor to the *Magazine of Natural History*, Mr. Dovaston, in vol. v. p. 116. of that work. Notwithstanding the plentifulness of fungi, we "very rarely find them without some visible (and never perhaps without some latent) excitement: such as dung, combustion, decomposing wood, or weeds; indeed, the seeds of fungi are so absolutely impalpable, that I have sometimes thought they are taken up with the juices into the capillary tubes of all vegetables, and so appear, when decomposition affords them a pabulum and excitement, on rotten wood and leaves: and this seed is produced in such excessive quantities, thrown off so freely, and borne about so easily, that perhaps there is hardly a particle of matter whose surface is not imbued therewith; and had these seeds the power of germinating by mere wetness alone, without some other exciting

cause, all surface would be crowded with them, and pasturage impeded." The object of Mr. Dovaston's paper is to account for the appearance of mushrooms and other fungi in those circles in grass land which are called fairy rings; and he attributes their thus appearing to the excitement of electricity. The above remarks, sufficiently heterogeneous in themselves, are not offered as any attempt at elucidating the subject which Mr. Merri-
 rick's query has excited, but as clues and considerations attached to the subject, which any correspondent will much oblige us by farther evolving. — *J.D.*

A remarkable Variety of the Common Oak. — Sir, Herewith I transmit to you specimens of a singular variety of the common oak (*Quercus Robur*), the peculiarity of which consists in the leaves being long, narrow, and for the most part destitute of the usual indentations so characteristic of oak foliage. (*fig. 152. a.*) You will observe that the leaves occa-



sionally evince a tendency, more or less, to indentation (*b* and *c*), especially those placed lowest on the shoot, i. e. the first that are expanded in the season: these are often of the usual form (*d*), and whole sprays, indeed, are to be found on the tree, bearing nothing but the ordinary foliage. The oak which produced the above specimens is a young growing tree, measuring, at breast high, little more than 3 ft. in circumference; it stands in a hedgerow, by the side of a lane, in this parish, and, I should judge, is of spontaneous growth. Though I have for many years been in the frequent habit of passing within a few yards of the tree, I never remarked any thing extraordinary in its foliage till last summer. Some acorns which I gathered from the tree last autumn have come up this spring, and bear the ordinary foliage, without exhibiting any of the peculiarities of the parent. Is the above variety worth propagating?

and if so, what is the best method to adopt for that purpose? It might, I think, without impropriety, be called *Quercus Rôbur* var. *salicifolia*. Yours, &c. — *W. T. Bree. Allesley Rectory, Aug. 17. 1832.*

Hybridisements of the Melon by the Cucumber. (p. 611.) — To Mr. Oliver's instance of this effect may be added the concurrent experience of M. Sageret, stated Vol. IV. p. 383. — *J. D.*

Limekilns and Burning of Lime. — A treatise on the best form of limekilns, the most economical fuel for burning lime, and the most economical method of using turf, peat, coke, coal, wood, furze, and faggots, with hard and soft limestone, blue lias, and chalk, is most exceedingly wanted. Is stone coal, Welsh coal, Staffordshire coal, or Newcastle coal, the best for the purpose? and what may be the proportionate differences of advantage and disadvantage, supposing them all at equal price? I would earnestly venture to direct your attention to this very practical subject. — *X. Y. Sept. 5. 1832.*

A work to the above effect would be very useful. Until one is published, we can only refer X. Y. to Mr. Menteth's excellent article on limekilns of varied structure, illustrated by figures, in our Vol. II. p. 399.; and to strictures on that article in Vol. III. p. 369, 370. In Vol. IV., also, p. 506., is a notice of a method of burning lime without kilns; and in Vol. V. p. 176., a mode of burning lime by moss, or peat, and clay, is briefly noticed. — *J. D.*

ART. IV. *Provincial Nurseries.*

UCKFIELD Nursery, Sussex. — This nursery was established, fifty years ago, by Alexander Cameron, uncle to the present proprietor, James Cameron. The extent of the concern is 12 acres, but in detached divisions, with a seed-shop and general assortment of seeds. At present there are only a small green-house and some framing; but Mr. Cameron is now building a new and extensive green-house, on an experimental plan of his own, of the excellence of which he is very hopeful. The nursery contains a good general assortment of fruit trees, forest trees, and of ornamental trees and shrubs; also of herbaceous plants, and of green-house plants as well, so far as the present extent of glass permits. The specimens of hardy evergreen shrubs are very superior, particularly the phillyreas, laurustinuses, Portugal and common laurels, aucubas, red and white cedars, &c. All the new fruits introduced by the London Horticultural Society are propagated here; and there are 112 stock trees, of as many sorts (for taking grafts from) of apples, including the original tree of the Alfreton, or Shepherd's Pippin. There is a very superior collection of georginas. Mr. Cameron connects with the business of his nursery the practice of contracting for new ground work and planting by the acre. — *J. C. Oct. 17. 1832.*

Carlisle Nursery; Messrs. Wm. and Thos. Hutton, has been established upwards of half a century. It contains a few acres, two green-houses, and several pits; and Messrs. Hutton have a seed-shop in Carlisle. The nursery is neatly laid out, and contains a tolerable stock of articles for local consumption. Among the new shrubs, we noticed *Ribes sanguineum*, and a double white *Helianthemum*, raised here from seed; and, among the herbaceous plants, a very distinct and handsome variety of *Potentilla atrosanguinea*, and a double-flowered *P. réptans*. The fuchsias, *Linum arboreum*, *Pittósporum*, and other half-hardy shrubs, stand out about Carlisle as well as about London. American plants also thrive well in this nursery. Some turnip and other seeds are raised here; and we found a plot, now ripe, guarded from other birds by a hawk in a cage. The hawk is found more to be depended upon than a boy or a girl.

Keswick Nursery; Mr. Kerr. — This nursery, which contains 12 acres, was established about the beginning of this century. The present occupier has only entered upon it lately and, from a state of neglect, is bringing it into order and keeping. The articles grown have hitherto been chiefly forest trees; but Mr. Kerr contemplates a general collection. There are, a green-house stocked with camellias and pelargoniums; a large specimen of *Pyrus salicifolia*, and of the gold-blotched beech; and a new seedling *Rhododéndron máximum*, of more free growth than the parent; a small seed-shop; and a few books, lent out gratis to such gardeners as feel inclined to borrow them.

ART. V. *London Horticultural Society and Garden.*

Oct. 2. 1832. — *Read.* A paper on the striped Hoisance Persian melon, by the author of the *Domestic Gardener's Manual*.

Exhibited. Flowers. Seedling georginas, from Mr. Ingram, of the royal gardens, Frogmore. A collection of georginas, from Mr. R. Chandler. A collection of georginas, three species of *Salpiglóssis*, and Chinese roses, from Mrs. Marryatt, F. H. S. Georginas, from Mr. Wm. Hogg, Paddington. Collection of georginas, and also of Livick's incomparable georgina, from Mr. James Young, F. H. S. A collection of georginas, from Mr. John Lee. — Fruit. Trumpet gourd, from the Marquess of Salisbury. Black prince, White Frontignac, and Black Hamburgh grapes, from Mr. George Leslie, gardener to J. Fleming, Esq., Hunt's Green. Adelaide apple, and Gansel's bergamot pear, from Thomas Hunt, Esq. Fifty-four sorts of apple, Prince's golden nectarine, and Rosanna peach, from a standard, from Mr. Joseph Kirke. Money's new St. Peter's, Escholata superb, and West's black St. Peter's grapes, from Mr. D. Money. *Láblab vulgáris* (from the open air), from Mr. H. Little, Gloucester Place, King's Road.

From the Garden of the Society. Flowers. *Sálvia cardinalis*, splendens, *chamædryòides*, *angustifolia*, and *Grahàmi*; *Fúchsia microphýlla*, *Lupinus ornátus*, *Amarýllis Belladónna*, *Erica Bowicàna*, *Eriophýllum caespitòsum*, *Ergéron* sp. from Douglas; Georginas. — Fruit. Peaches: Abricotée, Catherine, Chancellor, Braddick's North American; Sanguinole, Melting; President, late Admirable, preferable to any of the preceding. Apples: Rambour, large white Calville, Manks codlin; Wormsley pippin, a good bearer; Grey Leadington; Reinette de Lark, worthy of recommendation; Autumn pearmain, Scarlet queening, Drap d'or, Hoary morning, Nelson. Pears: Flemish beauty, specimen smaller than usual; Verlainé d'Été, Beurré de Capiamont, Belle et bonne; Fondantz d'automne, a very melting new sort, which at this particular season will prove an acquisition for supplying a kind of blank in the ripening of good sorts; Forme de Beurré Duquesne, Bergamotte Dertrycker, Belotte; Poire figue, synonyme Pistolette, and is the Knevett's pear of the London market, also received as Prince de Ligne, and Incourue Angoulême; Calbasse, Reine des poires; Alpha, a seedling raised by Mr. Braddick, good bearer; Duquesne d'Été, Cadet de Vaux, Jalonsie, Styrian. Grapes: White Nice, Wortley Hall, seedling; White Portugal, an excellent bearer. Onions: Tripoli, Spanish.

Oct. 16. — *Read.* A paper on the production of early peas, by Mr. T. Blake, F. H. S. A description of the varieties of cherry cultivated in the garden of the Society, by Mr. Robert Thompson. A paper on the cultivation of the queen pine-apple, by Mr. George Warren, gardener to Henry J. Grant, Esq. F. H. S.

Exhibited. Twenty-two sorts of apple, royal muscadine grapes from a south wall, and fruit of the same kind from a vineyard on a south border,

wheat ear carnations, and the scarlet-flowered arbutus, from Mr. J. Kirke. Flowers of 80 sorts of georgina from Messrs. Chandler. Fruit of the banana, and of *Passiflora laurifolia* and *edulis*, from the Earl of Shrewsbury. Plums from T. A. Knight, Esq. Pump apples from the Rev. S. Tucker. Flowers of georginas from John Reeves, Esq. Seedling georginas, raised in the years 1831 and 1832, and *Fuchsia arborea*, from Wm. Wells, Esq. Seedling grapes from E. Smith, Esq., Mill House, Sittingbourne. Queen pine, from H. J. Grant, Esq. Seedling georginas, from Mr. J. Veitch. *Celòsia cristata*, from Mr. Hain, gardener to Mr. Twining. Apples, from Mr. Mallet, 25. Charlotte Street, Blackfriars. Seedling apple, from Mr. Chandler, grown by Mr. Spencer, Adboulton, near Nottingham.

From the Garden of the Society. Flowers: *Calochortus luteus*, *Lupinus ornatus*, *Ferhena chamædrifolia*, *Sternbergia lutea*, *Cólichicum autumnale* double-flowered, *Hemerozállis dísticha*; *Sálvia Grahàmi*, *spléndens*, *cardinalis*, *angustifolia*, *chamædryoides*, and *involuta*; *Eriophýllum cæspitòsum*, *Tournefortia heliotropioides*; *Ròsa índica fràgrans*, *índica sanguinea*, *involuta*, *bracteata vera*, and *bracteata β scabriuscula*; *Cleòme speciosissima*, *Dendrobium Pierardi*. Georginas, anemone flowered georginas, and seedling georginas. — Fruit. Grapes: Wortley Hall seedling, White Nice. Pears: Duchesse d'Angoulême, Gendeseim, Marie Louise, from standards; Bon Chrétien fondant, from a standard, a good bearer, a very melting fruit; Seckle; Duc de Berri, first time of its fruiting in the garden; Sucre Vert, Verte longue panachée; Doyenné blanc, from a quince stock, from a thorn stock, and from a mountain ash stock; Moorfowl egg, from a mountain ash stock. Pears grafted on thorn, planted in good soil, come early into bearing; the fruit is fully larger than on the common stock, and the quality equally good, at least whilst the trees continue in a healthy vigorous state. The effect of the mountain ash stock appears to be to make the fruit later in ripening. As these stocks do not swell equally with the pear, it remains to be determined, in future, what the consequences will be in regard to the growth of the sorts, their duration, and quality of the fruit when the stocks get older and more contracted. A less supply of sap will then flow, which may probably occasion the fruit to be more gritty.

Nov. 6. — *Read.* A paper on the employment of cats in the care of fruit trees from birds, by P. Kendall, Esq.

Exhibited. Georginas, from Mr. Chandler. *Cereus truncatus*, and a basket of passion flowers, from Mrs. Marryatt. Black Hamburg grapes from a vinery without fire, the same kind from an open wall, White muscadine from an open wall, from John Allnut, Esq. Pomme de Neige, paper white and tasseled yellow chrysanthemums, from Sir Wm. Kay. *Pyrus domestica*, Boughton apple, 11 sorts of pears, Hawthornden apple, box of flowers of georginas, and a box of flowers of roses, from Mr. Stephen Hooker. A box of grapes, unnamed, from Mr. Rd. Ibeson, Adwick le Street, Doncaster. Green St. Vincent pine-apple, from a sucker planted Sept. 15. 1830, from Mr. George White, F. H. S., from Sir Rowland Hill's garden. Muscat Escholata, Escholata superb, and British seedling grapes, from Mr. D. Money.

From the Garden of the Society. Flowers. A species of *Erigeron*, from Mr. Douglas. *Lupinus ornatus*, two varieties of *Dichorizandra thyrsoiflora*, *Sálvia cardinalis*, *Hibiscus Lindleyanus*, chrysanthemums, and georginas. Fruit. Apples: Dutch mignonne, Gloria mundi, Reinette grise, Beauty of Kent, King of the pippins, Cockpit, Ross nonpareil. Pears: Napoléon, Duchesse d'Angoulême, Verte longue panachée, Bezi de la Motte, Bezi de Montigny; Charles d'Autriche, large and handsome, from a standard, the first time of its fruiting; Doyenné blanc, Whitfield, Beurré Diel. Grapes; Schloss Johannisberger, Rudesheimerberger, Grafenberger, Raisin rouge de Schlossberg à Kreutznach, Steinberger, White Kishmish.

ART. VI. Covent Garden Market.

<i>The Cabbage Tribe.</i>		From	To	<i>Pot and Sweet Herbs.</i>		From	To
		£ s. d.	£ s. d.			£ s. d.	£ s. d.
Cabbages, per dozen :				Parsley, per half sieve -		0 1 0	0 1 6
White - - - -	-	0 0 9	0 1 0	Tarragon, per dozen bunches	-	0 3 0	0 0 0
Red - - - -	-	0 1 6	0 2 0	Fennel, per dozen bunches	-	0 2 0	0 0 0
Plants, or Coleworts -	-	0 3 0	0 3 6	Thyme, per dozen bunches	-	0 2 0	0 0 0
Savoy - - - -	-	0 0 9	0 1 9	Sage, per dozen bunches -	-	0 2 0	0 0 0
Broccoli, per bunch :				Mint, per dozen bunches -	-	0 0 0	0 3 0
White - - - -	-	0 2 0	0 3 6	Peppermint, per doz. bun.	-	0 1 0	0 0 0
Green - - - -	-	0 1 0	0 1 6	Marjoram, per dozen bunch	-	0 1 0	0 0 0
Purple - - - -	-	0 0 6	0 1 0	Savory, per dozen bunches	-	0 1 0	0 0 0
Cape - - - -	-	0 0 9	0 1 6	Basil, per dozen bunches	-	0 0 0	0 1 6
<i>Tubers and Roots.</i>				Rosemary, per doz. bunches	-	0 5 0	0 0 0
Potatoes - { per ton		2 10 0	3 10 0	Lavender, dried, p. doz. bun.	-	0 3 0	0 0 0
{ per cwt.		0 2 6	0 4 0	Tansy, per dozen bunches	-	0 1 0	0 0 0
Kidney, per bushel -	-	0 2 0	0 2 3	<i>Stalks and Fruits for Tarts,</i>			
Scotch, per bushel -	-	0 1 9	0 2 0	<i>Pickling, &c.</i>			
Jerusalem Artichokes, per				Capsicums, per hundred -		0 5 0	0 8 0
half sieve - - - -	-	0 1 3	0 0 0	<i>Edible Fungi and Fuci.</i>			
Turnips, White, per bunch		0 0 1	0 0 1½	Mushrooms, per pottle -		0 0 9	0 1 6
Carrots, old, per bunch		0 0 4	0 0 6	Morels, dried, per pound -		0 14 0	0 0 0
Parsneps, per dozen -	-	0 0 9	0 1 0	Truffles, per pound :			
Red Beet, per dozen -	-	0 1 0	0 1 6	English, fresh - - - -		0 3 6	0 0 0
Skirret, per bunch -	-	0 1 6	0 0 0	Foreign, dried - - - -		0 14 0	0 0 0
Scorzoner, per bundle -	-	0 1 0	0 0 0	<i>Fruits.</i>			
Salsify, per bunch -	-	0 1 0	0 0 0	Apples, Dessert, per bushel :			
Horseradish, per bundle -	-	0 2 0	0 3 6	Fion's Pippins - - - -		0 7 6	0 0 0
Radishes :				Ribston Pippins - - - -		0 6 0	0 7 0
Red { per dozen hands (24		0 0 9	0 1 0	Pearmains - - - -		0 5 0	0 6 0
{ to 30 each) - - - -	-	0 0 0½	0 0 1	Golden Rennets - - - -		0 6 0	0 7 0
White Turnip, per bunch	-	0 0 1	0 0 1½	Baking, per bushel - -		0 2 6	0 4 0
<i>The Spinach Tribe.</i>				Pears, Dessert, per ½ sieve :			
Spinach { per sieve -		0 1 1	0 1 3	Chamontelle - - - -		0 7 0	0 10 0
{ per half sieve -	-	0 0 9	0 0 0	Cresanone - - - -		0 10 0	0 16 0
Sorrel, per half sieve -	-	0 1 0	0 0 0	St. Germain - - - -		0 6 0	0 10 0
<i>The Onion Tribe.</i>				Colmar - - - -		0 12 0	0 18 0
Onions, old, per bushel -	-	0 1 9	0 2 3	Baking, per half sieve -		0 1 0	0 1 6
For pickling, per ½ sieve	-	0 1 6	0 2 6	Quinces, per half sieve -		0 1 0	0 1 6
When green (Ciboules),				Medlars, per half sieve -		0 3 0	0 6 0
per bunch - - - -	-	0 0 3	0 0 0	Almonds, per peck - - -		0 7 0	0 0 0
Leeks, per dozen bunches	-	0 1 0	0 1 6	Chestnuts, per peck :			
Garlic, per pound - - -	-	0 0 6	0 0 8	English - - - -		0 2 0	0 3 0
Shallots, per pound - - -	-	0 0 6	0 0 8	French - - - -		0 5 0	0 8 0
<i>Asparaginous Plants,</i>				Filberts, English, per 100 lbs.		2 10 0	0 0 0
<i>Salads, &c.</i>				Pine-apples, per pound -		0 2 6	0 6 0
Asparagus, per hundred -	-	0 7 0	0 10 0	Hot-house Grapes, per lb.		0 1 6	0 0 0
Artichokes, per dozen -	-	0 4 0	0 6 0	Dutch, per dozen - - -		0 12 6	0 15 0
Lettuce, per score :				Portugal, per dozen -		0 7 0	0 10 0
Cos - - - -	-	0 0 9	0 1 3	Cucumbers, Frame, p. brace		0 2 0	0 3 0
Cabbage - - - -	-	0 0 4	0 0 6	Oranges { per dozen -		0 1 0	0 1 6
Endive, per score - - -	-	0 1 6	0 2 6	{ per hundred - - - -		0 8 0	0 12 0
Celery, per bundle (12 to 15)	-	0 0 9	0 1 6	Lemons { per dozen -		0 0 9	0 1 6
Small Salads, per punnet -	-	0 0 2	0 0 3	{ per hundred - - - -		0 4 0	0 12 0
Burnet, per bunch - - -	-	0 0 1	0 0 1½	Sweet Almonds, per pound		0 2 0	0 2 6
				Brazil Nuts, per bushel -		0 16 0	0 0 0

Observations. — Our supplies of vegetables have not been so heavy as usual at this season, except in turnips, owing to the prevalence of drought through the summer; but a general dulness has prevailed, which has kept down the prices to the present moderate quotations. Fruit has come to hand plentifully; but, in consequence of the very moderate prices obtained, a large proportion of apples has been kept for the purpose of making cider, the common sorts not realising enough to pay the cost of carriage and incidental expenses; the better varieties, either for sauce or table, are selling now moderately well, although the demand has not been at any time brisk. Pears, generally, have also been abundant, but not so large or fine as usual; many of the better sorts have been particularly (for our market) plentiful, but not considered so high in quality for the table as in general: some of the newer varieties have also been furnished, but they are not yet so generally cultivated as to insure a regular supply. Oranges

are just now coming into season ; but are not yet generally sought after, although the prices at present are very moderate. Of chestnuts we have had a moderate crop. Walnuts have been particularly plentiful, and of excellent quality, notwithstanding large supplies have been imported. Grapes have also been abundant, both from the houses and open walls ; which, with a large supply from Holland, has caused them to be very cheap. Pine-apples are now so generally cultivated as to make them almost plentiful at all seasons : they have sold this season lower than was ever before remembered. Onions have been harvested in large quantities, and in middling condition, and are likely to be plentiful and cheap throughout the winter. Potatoes are not so heavy a crop as usual ; but, in consequence of the excellent supply kept up in the river by the constant arrivals from all parts of the coast, they are not likely to be high in price. — *G. C. Nov. 22. 1832.*

ART. VII. *Provincial Horticultural Societies.*

ENGLAND.

BEDFORDSHIRE. — *Bedfordshire Horticultural Society. July.* This summer's show was remarkably fine, particularly the cottagers' vegetables. The principal prizes for the carnations and picotees were awarded to Messrs. J. B. Coter, Brinkles, Musgrave, Pullen, Bundy, Furze, and Clarke. Mr. Brinkles exhibited a fine seedling carnation Queen Adelaide, and a seedling picotee, Brinkles's Delight. The heaviest red gooseberry, the Roaring Lion, was exhibited by Mr. Nash : its weight was 26 dwts. 12 grs. The heaviest yellow was the Gunner, Mr. Furze ; weight, 24 dwts. 18 grs. Green, Troubler, Mr. Chapman ; 21 dwts. 17 grs. White, Governess, Mr. Pullen ; 22 dwts. 15 grs. The currants and raspberries shown were also very fine. (*Northampton Mercury, Aug. 4.*)

CAMBRIDGESHIRE. — *Cambridge Horticultural Society. June 27.* The principal flowers were ranunculuses, pinks, and roses. The first prize for the ranunculuses was given to Mr. F. Finch ; for the pinks, to Mr. Ripsher ; and for the roses, to Mr. Widnall.

August 12. Very numerous kinds of fruits and flowers were exhibited. The ironmonger gooseberry won the prize for flavour ; the roaring lion that for weight ; one berry weighed 1 oz. 22 grs. ; 42 bunches of red currants weighed 1 lb., and of white currants only 30 bunches. Excellent carnations and picotees were exhibited. Six prizes were awarded to cottagers. Seven extra-prizes were awarded. One to Mr. Widnall for a seedling georgina, which is stated to be "a most splendid production." One to Mr. Biggs, curator of the botanic garden, for a *Fuchsia multiflora*, which is stated to have excited general admiration. One to Mr. Denson, for a symmetrical and perfect spike of flowers of *Yucca gloriösa*. (*Cambridge Chronicle, Aug. 3. 1832.*)

Sept. 19. Many good things were exhibited at this show, but the most original among them were the georginas. This happens from the enterprise of Mr. Widnall, at Grantchester, near Cambridge, in this family of flowers, who devotes much time to the ascertaining where new varieties of merit are raised, and hesitates not to pay handsome prices for the exclusive possession of such, where they are to be purchased, and has himself, besides, raised several varieties of merit. As these causes not only insure that the kinds of georgina which he himself exhibits are choice, but that those put in competition with them are choice also, we give the names of all the georginas which won prizes at this show : — Georginas (12 double, one of a sort) : first prize, medal, Aurántia pállida, Prince George of Cumber-

land, Galathèa, Pure yellow, Paper white, Lady Grenville, Lord Liverpool, Widnall's Prince of Orange, Guttata, Widnall's éarnea, Surpasse triomphe royale, Nymphæiflora, Mr. Widnall; Second prize, King of the Whites, Cambridge Surprise, William the Fourth, Mogul, Mountain of Snow, Aurantia pallida, Lady Fitzharris, Imperiosa, Countess of Liverpool, Barret's Superina [?Susannah], Douglas's Augusta, Pure yellow, Mr. Robt. Nutter. Georginas (6 double, one of a sort): Countess of Liverpool, Lord Liverpool, Cambridge Surprise, Widnall's Black Prince, Widnall's Iris, China aster-flowered, Mr. Widnall.; Second prize, Countess of Liverpool, Augusta, Mountain of Snow, Queen of Roses, Constantia, Mr. Searle. Georgina (of any sort), Widnall's Perfection, Mr. Widnall. Georgina (seedling), Mr. Widnall. (*Cambridge Chronicle*, Sept. 21. 1832.)

Cambridge Florists' Society.—*July 30.* 1832. This was the seventh annual show of this Society, and at it were exhibited some excellent flowers of carnations, picotees, and georginas. Mr. Catling won the premier prize for the best carnation, by Wilde's Perfection; and Mr. Nutter that for the best picotee, by Wood's Countess of Sandwich. Mr. Twitchet and Mr. Purchas seem to have won many prizes among the carnations and picotees. (*Cambridge Chronicle*, Aug. 3. 1832.)

CORNWALL.—*The Royal Horticultural Society of Cornwall. June 29.* 1832. This Society has King William the Fourth for an annual subscriber of ten guineas: hence it is called royal. The pines, melons, strawberries, cherries, and other kinds of fruit were of superior quality. Of flowers there was a copious supply, and the competition was, in consequence, very spirited. *Ficus elástica*, *Amaryllis vittata*, and *Vallota purpurea* are mentioned. "The most remarkable plant in the room was a new species of *Cornus*, raised from Nepal seeds, some years ago, in the garden of J. H. Tremayne, Esq. at Heligan. It is a handsome shrub, perfectly hardy, and bears a profusion of large white blossoms." The show of vegetables was commendable. Prizes were awarded for indigenous plants, and for cottagers' productions. (*West Briton and Cornwall Advertiser*, July 6. 1832.)

August 16. This was but the second show of the Society, but the emulation which prevailed caused the display of flowers, fruit, and vegetables that adorned the room to far exceed the expectations of the most sanguine. *Gloriosa superba* and *Brunsvigia Josephinae* were the rarest plants shown. The Rev. Robert Walker exhibited specimens of a new grass adapted for soiling: it appeared to be a species of clover. After the prizes had been announced, a number of copies of a little poetic effusion of the veteran bard of Cornwall [who is he?], entitled *Floral Emblems*, were distributed among the company, having been liberally presented by Mr. Polwhele. At the dinner the gratifying announcement was made, that His Majesty has been most graciously pleased to direct an annual subscription of ten guineas to be paid to the funds of the Society. (*West Briton and Cornwall Advertiser*, August 24. 1832.)

October 11. This was but the third exhibition of this Society, and the chairman, Sir C. Lemon, Bart., in remarking the perfect success of the attempt to form it, observed, "It would be strange indeed if it had been otherwise, as there is no county which possesses superior advantages, in a horticultural point of view, to our own. The salubrity of its climate, and the genial mildness of its temperature, are well known. Many plants which will not endure the common winters of other parts of England without protection, are to be seen in the gardens of Cornwall flourishing in almost their native luxuriance. In this respect," continued the hon. baronet, "our climate is particularly favourable for making experiments on the comparative hardiness of exotic plants. There are few, he supposed, who had not at one time or other had the curiosity to enter on this interesting subject. He had himself pursued it to some extent, and, he might add, with tolerable success. Should any one be desirous of visiting

his gardens, he would be happy to point out to them those plants which appeared to him to be acclimatised. He hoped the matter would not be lost sight of by the Horticultural Society, and that it might receive an additional impulse from the members communicating, at some of their future meetings, the results of their several experiments. With respect to the botany of Cornwall, he was led to believe it was not yet sufficiently understood. There were several plants, whose names at that moment were not familiar to his mind, which he knew to be almost exclusively confined to Cornwall. One of these, the *Erica ciliaris*, was added to our English flora a very few years ago by himself. It was also found much about the same time in the vicinity of Truro, by the Reverend Mr. Tozer; and it was remarkable that this beautiful plant should have remained so long unnoticed, as it covers a space in one of his (Sir C. L.'s) plantations of from 15 to 20 acres in extent." — The assortment of fruit was very extensive, particularly of melons, apples, and pears. Of flowering plants, several species, and many fine specimens, were exhibited: of those named, the rarest are *Ipomœa insignis*, *Jatropha multifida*, and *Cornus capitata*, a handsome evergreen from the East Indies, perfectly hardy. The assortment of vegetables was pretty extensive, and the samples large and handsome. We noticed among them a variety of white beet, which is not so much cultivated in our gardens as we think it deserves. It is the *Poirée à carte blanche* of the French, and in our opinion an excellent vegetable. The manner of dressing and using it, we believe, is similar to sea-kale.

Indigenous Plants. Judges, W. M. Tweedy, Esq., Mr. W. B. Booth, Assoc. Linn. Soc. London. Most rare species of indigenous plants: *Sálvia pratensis*, R. W. Fox, Esq.; second ditto, *Antirrhinum Cymbalaria*, R. W. Fox, Esq. Best group, *Scrophularia Scorodonia*, *Asplénium lanceolatum* and *marinum*, *Támarix gállica*, *Orobánche major*, *O'phrys spirális*, Miss Warren; second best group, *Allécebrum verticillatum*, *Asplénium marinum*, *Pinguicula lusitánica*, *Sparganium ramosum*, B. Sampson, Esq. The admirers of this interesting branch of botany are gradually increasing.

Cottagers' Prizes. The productions in this class were all, more or less, deserving of great commendation. The good effects of the Society are already beginning to appear, in the excitement it has given to the industrious cottager. We doubt not but the rewards which have this year been distributed will induce a large portion to enter and compete for the prizes that will be given next season. Indeed, we think it is not too much to hope that in the course of a few years a great improvement will be visible, both in the exterior appearances and interior arrangements of our numerous cottages. As a distinguished writer ingeniously remarks that the face is an index to the mind, so are we of opinion, that the neatness and cleanliness of the cottager's garden is a proof of the happiness and comfort within. (*Cornwall Royal Gazette*, Oct. 20.)

CUMBERLAND. — *Whitehaven Horticultural Society's Flower Show.* Aug. 10. 1832. The display of flowers was a very magnificent one: there was an immense variety of carnations, picotees, and georginas; and the prize flowers were deemed very good. Two very noble specimens of *Campánula pyramidalis* were shown. Mr. R. Elliott showed a new variety of potato, raised from seed: the tubers were remarkable for their size and beauty. Although this is called a flower show, numerous fruits were exhibited, and these are highly praised by the reporter. There was a plate or two of apples, of last year's growth, uncommonly well preserved. "Gooseberries have not been fine this year; the long-continued dry weather hurt them, especially the larger kinds, much. The choicer of the plants exhibited were *Kalosánthes coccinea*, a *Cyrtánthus*, an *Erythrína*, *Trachélium cærúleum*, and *Calceolària plantagínea*. There was a prize for a nosegay of indigenous flowers. (*Whitehaven Herald*, Aug. 14. 1832.)

DEVONSHIRE. — *North Devon Horticultural Society. July 4. 1832.* There was a very splendid display of flowers, a plentiful show of fine fruit, and an award of many prizes for them, and of several to cottagers for their productions. Much taste was displayed in the decoration of the walls and other parts of the show room, and the initial letters of the names of patrons were formed with a variety of beautiful flowers. The chairman announced that the foundation of a botanical and horticultural library had been laid by contributions from several members." A prize was awarded for the six best varieties of heartsease. *Gladiolus natalensis* was exhibited by Mr. Burge. (*County and North Devon Advertiser, July 6. 1832.*)

Devon and Exeter Botanical and Horticultural Society. — Oct. 4. The displays of fruit, vegetables, and flowers, and the company to inspect them were most gratifying. A triumphal arch was formed in the room, of evergreens and flowers; and the pillars sustaining the arch were formed of about 1000 flowers of georginas in numerous varieties. Mr. Veitch showed flowers of the Hanoverian striped georgina, which were much admired, and so were his Chinese asters, raised from seeds obtained of the London Horticultural Society. Mr. Booth's citron trees are eulogised, and their fruit won a prize. Among the flowering plants, which were rather numerous, and some of them choice, we noticed "a remarkably grand specimen of the *Datura arborea* in flower, and finely branching." No plant can be more superb than this. Messrs. Lucombe and Co. exhibited a specimen of *Nepenthes distillatoria*, the pitchers of which were much admired for their "elegance and truly classical form." The display of fruits on this occasion has not been surpassed in the eleven previous shows of the Society. Messrs. Dymond and Co. exhibited one bunch of the Muscat from Lunelle, which weighed 3 lbs. 10 oz. The vegetable tribes gave proof of the efficacy of the Society; and of the stimulus that has by means of it been generally imparted; and several cottagers made creditable displays. Of home-made wines there was a variety of samples; nor should those from Mr. Gifford's, especially that from the green grape, pass without mention. Of preserved and dried fruits there were many specimens, and some very fine plums of the growth of 1830.

After the judges had finished their labours, John Milford, Esq., was called to the chair, and addressed the company that filled the room. Among his remarks were these:— After speaking on the perfect success of the Society, and the good it had effected, he observed, "It is my earnest hope, that every year the public may derive benefit as well as amusement from our establishment: benefit in the improved state of our markets, by the introduction of new and rare vegetables and fruits; and amusement, from the contemplation of such objects as are now before you. I will avail myself of the present opportunity to make a few observations on our library, which consists of some standard works on botany and horticulture, together with periodicals on the same subjects. As an individual I have found our reading-room a great resource, and spent many hours there both with amusement and instruction. I regret that it is not more generally resorted to, as my wish, in common with the wishes of those persons who were mainly instrumental in the early formation of the Society, was, to combine a little science with our amusement, so as to prevent our Society dwindling into a mere flower show. I could wish that our practical skill in the art of gardening, an art which is now exciting such universal interest in almost every civilised state, should with us be accompanied by some scientific development. Although the present state of our funds does not justify the committee in recommending the adoption of the more extended plan at first contemplated, I mean the formation of a botanic garden, I trust, notwithstanding, that the advantage of a well selected library may diffuse a taste for botany and horticul-

ture in every part of our beautiful county, which has justly been denominated the garden of England." (*Exeter Flying Post*, Oct. 11. 1832.)

DURHAM AND NORTHUMBERLAND. — *Botanical and Horticultural Society of Durham, Northumberland, and Newcastle upon Tyne*. July 6. The best exotic plant in flower displayed at this Meeting was *Crinum pedunculatum*. Mr. Thomas Pearson, gardener to Isaac Cookson, Esq., Gateshead Park, is the individual to whom was awarded the sum of three guineas offered to the gardener who produced the best testimonials of his abilities, and of the greatest length of servitude in one family; Mr. Pearson having lived gardener to Mr. Cookson upwards of twenty-one years. There were twelve pines on the table: that which won the gold medal was a Black Antigua, and was allowed by the judges to be the highest flavoured they ever tasted: it was grown by Mr. William Kelly, gardener to A. Donkin, Esq., Jesmond. (*Newcastle Courant*, July 14. 1832.)

Aug. 31. 1832. This was the Anniversary Meeting and dinner, and the majority of the numerous prizes seem to have been won by gardeners. Between thirty and forty members and friends dined. After dinner the toasts, speeches, and songs were numerous. On the health of the secretaries being drunk, Mr. Falla, one of them, among other remarks, observed, that "the only claim of merit that he could make was, that he had had something to do with the establishment of the library of the Society. He hoped the day was not far distant when the Society would become more scientific than it had been hitherto; and when it would possess a garden. He respectfully begged to renew his promise, when that took place, that he would, with the greatest pleasure, present the Society with a specimen of every plant he had in his nursery, and superintend the planting and arrangement of the same." (*Ibid.*, Sept. 8. 1832.)

The Heworth Florists' and Horticultural Society exhibited pinks on July 7. 1832, when the winning kinds were Becksley's Beauty, Prince Leopold, Adelina, Lord Wellington, and Princess Charlotte. (*Ibid.*, July 14. 1832.)

ESSEX. — *Chelmsford Florists' Society*. July 31. 1832. Carnations, picotees, georginas, and fruits were the productions exhibited, and these were of a superior description. Among the prizes for georginas, Mr. Sorrell of Chelmsford won a prize by Sorrell's Chelmsford Surprise, along with other generally known kinds. (*Essex Independent*, Aug. 3. 1832.)

Chelmsford and Essex Floral and Horticultural Society. — July 2. 1832. Roses, pinks, pelargoniums, irises, cut flowers, strawberries, melons, cherries, and cauliflowers. The strawberries were numerous, the geraniums handsome; and the cauliflowers, for the time of year, very fine. (*Essex and Suffolk Press*, July 10. 1832.)

Sept. 11. Georginas were numerous; and the Rev. W. Jesse and Mr. Sorrell won the prizes for seedling kinds. The Carotte Violette, or purple carot, and long white carot, Carotte Blanche, won prizes. A more magnificent display of fruits and flowers was never witnessed. A drawing of moss roses, by Miss Fearnley of Springfield, possessing great merit, was most deservedly admired. (*Essex Herald*, Sept. 18. 1832, quoted from the *Chelmsford Chronicle*.)

HEREFORDSHIRE. — *Hereford Horticultural Society*. July 31. 1832. Carnations, picotees, georginas, flowering plants, and fruits were the objects shown. In the picotee class, the yellow ones surpassed every thing of the kind ever shown here; and the difficulty of cultivating and blooming them so perfectly was duly appreciated, and of course rewarded by prizes. The other picotees and carnations were unusually large, excellent, and in full supply: amongst the latter appeared a rose flake, possessing great merit, and raised from seed by Mr. William Townsend, cutler, of this city, to whom a first prize was awarded. In the georginas, some prime seedlings were displayed, and one, in particular,

distinctly and broadly striped; which circumstance we hail with great satisfaction, and doubt not that, in a few years, georginas will be produced as much diversified by stripes as carnations. The gooseberries were very abundant, and many of them not only very large, but good as well as great: indeed, the prejudice against large gooseberries is fast wearing away, as some of them may be brought into competition as to flavour even with the old rough red. There were some berries exhibited from a seedling plant by a non-subscriber, possessing size and richness of flavour in an eminent degree. The plums were not sufficiently matured, but the pines, melons, peaches, nectarines, apricots and grapes were of first-rate size and quality; and, to crown all, a highly respectable and numerous assemblage honoured the excellent display with their presence and approbation. The names of the gooseberries which won prizes, are, red, Crown Bob, Roaring Lion, King's Globe; green, Ocean, Greenwood's Green; yellow, Royal Gunner, Golden Chain, Orange Globe. Mr. Godsall won three of these prizes, and several prizes for other objects. (*Hereford Journal*, Aug. 15. 1832.)

Sept. 21. At this last show for the present year georgina flowers were profusely abundant; among them were many seedlings, several of which were broken into distinct stripes; the peaches, nectarines, plums, and grapes were abundant and excellent. 84 varieties of apples and 25 of pears were exhibited, most of them of extraordinary size and beauty. Miss Anne Parry exhibited a "double [flowered] *Eschscholtzia*." Mr. Godsall, nurseryman, has won the greatest number of prizes in this Society during the year. (*Ibid.*, Sept. 26. 1832.)

Ross Horticultural Society.—July 25. 1832. The carnations and picotees were of the first quality and in prime bloom, and the stage of them was admitted by all florists present to be the best they had ever witnessed. Georginas were in great abundance and in great beauty; and the first prize among the light kinds, namely the purple-fringed, was universally admired, the petals being fringed with purple, like the best picotee. The gooseberries, from the dry weather, were not so large as they are usually seen at the show at this season, but the other fruits were the admiration of all. Numerous prizes were awarded for carnations, picotees, georginas, balsams, cockscombs, and house plants, *Hoya carnosa*, *Phenacoma prolifera*, *Kaliosinthos coccinea*, *Erica ampullacea*, *infundibuliformis*, and *Parmenitèria rosea*. Among the gooseberries the winning kinds were, red, Roaring Lion, Crown Bob, and Warrington; green, Greenwood's Green, Lancaster Lad; white, Woodward's Whitesmith; yellow, Golden Lion, Queen of the Yellows, and Amber. (*Ibid.*, Aug. 1. 1832.)

Sept. 19. Georginas in abundance, peaches, nectarines, out-of-door grapes, apples, pears, melons, heaths, and vegetables were exhibited. The report of the show is closed with the following remarks on Indian Corn:— "In a former journal we stated that Mr. Palmer of Pencoyd, and Mr. Palmer of Bolitree, near Ross, this year cultivated several acres of what is generally termed Cobbett's corn, and that the crop promised to be very fine. This expectation has been fully realised, and we have received a cob or ear from one of the fields, of great size and perfection. The following method of cultivation was adopted by Mr. Palmer of Pencoyd:— The crop was planted on the 10th of May, on ridges 6 ft. over, two rows on the top of each ridge; it was hand-hoed on the 16th, 18th, and 19th of June, and some were transplanted on the 28th to fill up the vacancies caused by the ravages of the black beetles, which are very destructive to the plants when in an infant state. On the 14th of July, and following day, the intervals between the ridges of corn were ploughed deeply, approaching to within 3 in. of the plants: on the 20th, the taking off the suckers which spring up at the footstalk of the plant commenced; and on the 26th, the earth which had been ploughed from the ridges on the 4th and 5th July, was turned

back to them. After this ploughing, the corn grew prodigiously, and, as far as promise could go, 'gave the lie direct to the wiseacres who said there would be no crop.' On the 7th August, Mr. Palmer gave the corn a second ploughing between the ridges, the same as before, except that he did not approach quite so near to the plant. The high winds about the latter end of the month having knocked the crop about, which had then attained the height of 4 ft., some men were put to earth it up after the manner of teasels. Yesterday Mr. Palmer commenced cutting away the tops and blades, leaving the ears standing on the footstalks to harden for another fortnight, or three weeks, when he will commence harvesting the crop. Mr. Palmer observes, 'that there is a crop, and a productive one, too, any man may satisfy himself who will take the trouble; and the specimen you have will show the state of perfection at which it is already arrived.'" (*Hereford Journal*, Sept. 26. 1832.)

LANCASHIRE. — *Lancaster Floral and Horticultural Society*. August 3. 1832. The carnations and picotees exhibited were good, although not very numerous. Miss Dalton exhibited a magnificent specimen of *Yucca gloriosa*. The georginas were superb. Of the carnations, Wild's Perfection won the first prize among the scarlet bizarres; Wakefield's Paul Pry the first among the pink bizarres; Turner's Princess Charlotte the first among the purple flakes; Wilson's Mountaineer, the first among the scarlet flakes; Clegg's Smiling Beauty, the first among the pink flakes. Of the picotees, Boothman's Victoria won the first prize among the purple kinds, and Kenny's Incomparable the first prize among the red kinds. The kinds of gooseberry which won prizes are, red, Top Sawyer and Roaring Lion; yellow, Rockwood and Gunner; green, Greenwood and Independent; white, Wellington's Glory and White Eagle. That beautifully and freely blooming hardy green-house shrub, *Ceanothus azureus*, was much admired, and was honoured with a prize. (*Lancaster Herald*, Aug. 4. 1832.)

Lancaster Horticultural Society. — Oct. 6. The shows of this Society have in previous years been confined to the summer months; but, in compliance with the wishes of the lovers of fruit, an autumnal show was attempted. Mr. Ronalds of Brentford sent named specimens of many varieties of apple to Mr. Saul, who exhibited them, and also 26 sorts furnished by himself. Dr. Stevenson of Gilmerton, near Edinburgh, sent 60 varieties. The Rev. Thos. Mackreth of Halton, also, supplied upwards of 26 varieties. Mr. Saul, at the end of the show, distributed the apples supplied by himself and his friend, Dr. Stevenson, to the persons present: an opportunity of tasting new fruit, of which many were delighted to avail themselves. Besides apples, pears, figs, grapes, pumpkins, and many other fruits and vegetables, and many varieties of georgina, were exhibited. (*Lancaster Gazette*, Oct. 13. 1832.)

ART. VIII. Obituary.

DIED, on the 8th of October, 1832, *Mr. William Johnstone Shennan*, aged about 40 years, formerly of Gunnersbury Park, and late gardener to Edward Baker, Esq., of Salisbury. Mr. Shennan having been well known to you and many of your readers, I need only observe, that, as a practical gardener in every branch of his profession, there were few to excel him. As a last tribute to his memory, after an uninterrupted friendship of nearly twenty years, allow me to add, that a more upright man, and more sincere friend, did not exist. — *Robert Reid*. *Cothelston*, Oct. 25. 1832.

INDEX

TO

BOOKS REVIEWED AND NOTICED.

GENERAL SUBJECT.

- An Address to the Labouring Classes, not. 202.
Arcana of Science and Art, for 1832, not. 202.
Braidwood's work on the Construction of Fire Engines and Apparatus, not. 203.
Bryan's Practical View of Ireland, not. 203.
Cape of Good Hope Literary Gazette, not. 718.
Dewhurst's Practical Observations on warming Dwelling Houses, Cathedrals, Churches, Theatres, and other Public Buildings with Hot-water, noticed, 221.
Don's General System of Gardening and Botany, not. vol. i. 203; vol. ii. 698.
Doyle's Hint's on Emigration to Upper Canada, not. 718.
Facts and Illustrations demonstrating the important Benefits derived by Labourers from occupying small portions of Land, not. 202.
Henslow's Examination of a Hybrid Digitalis, not. 208.
Hooker's Botanical Miscellany, not. 204. 712.
Lindley's Introduction to Botany, not. 705.
Moggridge's Popular Education in France, not. 199.
Our Neighbourhood: or, Letters on Horticulture, &c. 454.
Payne's Apiarian's Guide, prospectus of, 463.
Poiteau and Vilmorin's Le Bon Jardinier, not. 453.
Quarterly Journal of Education, not. 193.
Sinclair's Hints on Vegetation, 204.
Sussex Association for improving the Condition of the Labouring Classes, not. 199; Quarterly Report of the, not. 200.
Time's Telescope for 1832, not. 202.
Transactions of the Albany Institute, America, noticed, 719.
Vegetable Diet not inductive of Cholera, not. 719.

LANDSCAPE-GARDENING.

- Gilpin's Practical Hints on Landscape-Gardening announced, 224; not. 700.

FLORICULTURE.

- Additional Supplement to London's *Hortus Britannicus*, announced, 224; not. 604.
Blume's Flora Java, not. 707.
British Flowering Plants, not. 715.
Chandler and Booth's Illustrations and Descriptions of the *Camellia*, not. 211.
Curtis's Botanical Magazine, not. 224. 345. 454. 596. 721.
Edwards's Botanical Register, not. 224. 345. 454. 596. 721.
Haworth's *Narcissinearum* Monographia, 2d edition, not. 212.
Hooker's and Greville's Figures and Descriptions of Ferns, not. 706.
Loddiges's Botanical Cabinet, not. 224. 345. 454. 596. 721.
Mackay's Catalogue of the Phanogamous Plants and Ferns of Ireland, not. 716.
M'Nab's Treatise on the Propagation, Cultivation, and General Treatment of Cape Heaths,

- in a Climate where they require Protection during the Winter Months, not. 210.
Mantell's Chart of Floriculture, not. 716.
Maund's Botanic Garden, not. 224.
Nees von Esenbeck's Genera and Species *Asterarum*, not. 714.
Smith's and Sowerby's English Botany, second edition, not. 714.
Sweet's British Flower-Garden, not. 224. 345. 454. 596. 721.
Wallich's *Plantæ rariores Asiaticæ*, not. 717.
Wenström's *Handbok i Blomsterkulturen för Fruntimmer*, not. 720.

ARCHITECTURE.

- Leigh's Music of the Eye, 205.
Loudon's *Encyclopedia of Cottage, Farm, and Villa Architecture*, announced, 221; not. 344.

ARBORICULTURE.

- Horton's Tables for Planting and Valuing Underwood and Woodland, &c., not. 208.
Matthews on Naval Timber and Arboriculture, not. 702.
The Mullan Forester, not. 208.
The Planting of Forest Trees, in Four Numbers of the Farmer's Series of the Library of Useful Knowledge, not. 207.

AGRICULTURE.

- Cleghorn's System of Agriculture, not. 220.
Lambert's Rural Affairs of Ireland, rev. 215.
Proceedings of the Pennsylvania Agricultural Society, 454.
Riley's Remarks on the Importation of the Cachemire, and Angora Goats into Europe, and of the hybrid kind Cachemire-Angora into Australia, 452.

HORTICULTURE.

- Antoine's Figures from Nature of 51 Sorts of Peaches, not. 720.
Callow's Treatise on the Cultivation of the Mushroom, 213.
Catalogue of the Fruits cultivated in the Garden of the Horticultural Society of London, 2d edition, not. 212.
Jacquin's *Monographie complète du Melon*, not. 453.
Lindley's Outlines of the First Principles of Horticulture, announced, 463., not. 703.
Memoirs of the Caledonian Horticultural Society, Vol. IV. Part II. rev. 178; Vol. V. Part I. not. 205.
Sowerby's Mushroom and Champignon illustrated, not. 224.
Transactions of the Horticultural Society of London. Second series. Vol. I. Part I. rev. 177.
Verhandlungen des Vereins zur Beförderung des Gartenbaues in den Königlich-Preussischen Staaten, Vol. II. rev. 187.

GENERAL INDEX.

- ACA'CIA Julibrissin*, 35 ft. high, near Philadelphia, 272.
- Acclimatising half-hardy exotics to the seasons of Britain, 45; Bowie's directions for acclimatising, in the gardens of Britain, the plants of Australia and the Cape of Good Hope, 5; a list of the plants which have stood out at Drumcondra, near Dublin, during one or more winters, 568; list of exotics which have lived for several years in the gardens of Charles Hoare, Esq. at Luscombe, Devon, 566; *Nerine humilis* and *undulata*, nearly hardy, 81.
- Acer, the species of, whose sap is used in America for the formation of sugar, 503.
- Admirable, a drink, a method of making, 182.
- Æcidium laceratum*, a fungus parasitic on hawthorn, 179; *Æcidium*, a species of, parasitic on the leaves and fruit of pear trees, 738.
- Agriculture, remarks appertaining to, 220; on chloride of lime in, 445; British Society of Agriculture, 89.
- Alder, common in light sandy soil, grows more rapidly than birch, 456.
- Almond tree, double flowered, 737.
- Amarýllis, M. Otto's remarks on the culture of the genus, 188; *Amarýllis gigantea*, and its culture, 189; formosissima seeds in the open air, in England, 94.
- America, North, notices on, 70; wild shrubs of, 75; geology of Philipsburgh in Pennsylvania, 76; the treatment received in the United States by a young British gardener, 360; Mrs. Trollope's book on America noticed, 360; sugar procured in America from the sap of species of maple, 502; critical notice of Mrs. Trollope's account of the indigenous flowers and fruits of the state of Ohio, 374.
- America. See Nurseries.
- American blight. See Aphis.
- Ammoniacal liquor of coal gas, destroys insects and vermin, 41; a mode of applying it, 656.
- Andrómæda arborea*, 75 ft. high, near Philadelphia, 272.
- Angles, an instrument for laying off or transferring them, in practical gardening, 30.
- Annual flowering plants, the seeds of some species of, should be sown in autumn, 570.
- Ants, a means of destroying, 148.
- Aphis lanigera, on apple and other trees, a means of destroying, 53, 149; the Aphis, on peach and nectarine trees, a mode of destroying the, 580.
- Apple, the kinds of, which thrive in the neighbourhood of Kilkenny, and their characteristics, 165; early kinds of, 167; middle season kinds of, 168; late keeping kinds of, 179; kinds of apple eligible for making cider, 244; information and a query on the Shustoke pippin apple, 610; a ladder held up by ropes for gathering apples, &c., 581; remarks on the relative value for cider of the golden pippin, Chasely Harvey, Flanders pippin, and other kinds of apple, 583.
- Apple powder, the Chelsea, enquiry on, 610.
- Apple trees, on raising them from pips, 317; apple trees trained to a wall built at an angle of 10 deg. to the earth's horizon, produced an abundance of fruit, 183; a mode of destroying the bug, or Aphis lanigera, on apple trees, 52, 357; Kirke's emperor apple tree, sported with double flowers, 737.
- Apricot, Mr. Thompson's report on the varieties of, 433.
- Aquarium, a mode of forming an, 84.
- Arália spinosa*, 25 ft. high, near Philadelphia, 272.
- Architecture, notices on, 205; Loudon's *Encyclopædia of Architecture*, its plan and scope, 221; architecture about London, criticisms on, 473.
- Armagh palace, gardens at, 81.
- Arrow-root, the method by which the inhabitants of Otaheite prepare, 585; queries on the quantity of tubers in relation to the space the plants occupy, and on the quantity of fecula in proportion to that of tubers, 736.
- Artichoke, a variety of, its blanched leafstalks are much eaten at Rome and Naples, 267, 271.
- Asparagus, hints on cultivating, 180; at Berlin, green asparagus is preferred in winter, blanched asparagus during spring, 450; Prussian asparagus, *Ornithógalum pyrenæicum*, described, 613.
- Auchincruive, its charms and features sketched, 595.
- Auriculars, the management of, and soil for, in low situations, queried 736.
- Australia, notices on, 77; Bowie's hints on cultivating and acclimatising, in England, the leguminous plants of Australia, 15.
- Awning and frame, cheap, for shading florists' flowers grown in beds, 45.
- Bagnoles Wells, some account of, 63; the vegetable productions of the neighbourhood of, 356.
- Balsam, *Balsamina hortensis Desportes*, an investigation of its structure, 403.
- Bark of trees, a recipe for promoting its growth over barkless places, 150.
- Barley, information and queries respecting agricultural horses fed on, 613; barley big, its history and uses, 95.
- Batata. See *Ipomœa Batatas*.
- Bean, field (*Faba vulgaris*), a very vigorous plant of, 187.
- Bee, the honey bee has the power to generate a queen, 498.
- Beech, purple-leaved, the seeds of, produce some purple-leaved seedlings, 445.
- Beehive, Huish's, corrections to the printed dimensions of, 375; Young's description of two kinds of beehive, 664.
- Beer from sugar mixed with inferior malt or unmalted barley, 95; cheap beer for gardeners and their workmen, modes of producing, 61; ale, how to make, from the man-gold wurzel, 697.
- Beetles, black, a means of destroying, 148.
- Berries, some wild white and red in Norway, of what plants? 611.
- Beulah Spa, its gardens noticed, 594.
- Birch, *Bétula álba*, economical properties of, 93; grows not so fast as alder on light sandy soil, 456.
- Birmingham botanical and horticultural garden, Mr. Loudon's plans for, 407; gardens of the workmen at Birmingham, 79.
- Boiler, Neeve's improved forms for boilers, attached to apparatus for heating by hot water, 28.
- Botanical and horticultural society: Bristol, 118; Bristol and Clifton, 119; Devon and Exeter, 627, 748; Hexham, 632; Manchester,

- 115; Newcastle, 252; Northumberland and Durham, 118, 631, 749.
- Bourne, Frederick, Esq., his garden near Dublin, noticed, 83, 571, 482.
- Brandy, home, a mode of making, 180; a kind of brandy called *maroschino* is made from the fruit of *Prunus mas-fidrens*, 188.
- Brassica, an alternative for avoiding the club in the roots of the different species of, 55. See also Cabbage.
- Bretton Hall, the green-houses and hot-houses at, remarks on, 361; counter remarks, 607.
- Bridge-building, 59.
- Broccoli, Portsmouth, the cause of its superiority sought, 612.
- Brugmansia suaveolens*, noticed, 47; on the cultivation of, in a conservatory, 159; M. Sinning's mode of cultivating, 195.
- Brussels botanic garden, 400.
- Buckwheat, a blue colour obtainable from, 42.
- Bury St. Edmunds, new botanic garden at, briefly noticed, 79.
- Button wood trees, *Platanus occidentalis*, of very large size in the United States, 153.
- Cabbage, sea or wild, its excellence as a sauce, 54; an alternative for avoiding the club in the roots of the cabbage tribe, 55; the Jersey cow cabbage, complaints on the exaggerated account of its capabilities, 608.
- Cactæe, increased introduction of, into our collections, 47. Cactus, see *Cereus*.
- Catadium bicolor* and *viviparum*, M. Sinning's method of cultivating, 195.
- Calceolaria, additional hybrid kinds of, 48; C. *Atkinsiana*, noticed, 473, 724; C. *Martincana*, noticed, 723.
- Calystegia sepium* and *Ipomœa*, their corollas differ in the mode of withering, 736.
- Camellias, interesting kinds of, named, 211; the management proper to camellias when forced, 435; the flowers of camellias are rare and dear at New York, 360.
- Cámara lucida*, its efficient service in drawing, 257.
- Camphor useful to revive withered plants, 339.
- Canker in fruit trees, the effect of a bad sub-soil; a mode of preventing it, 326; a mode of curing it when not the effect of soil, 696.
- Caoutchouc dissolved in pyrolignous ether preserves twine or cord boiled in it, 554; what is the mode of dissolving it? 735.
- Cape of Good Hope, Bowie's hints on cultivating in England the leguminous plants of, 5.
- Carnation, history and culture of, 428; Mr. Hogg's carnation bloomed very satisfactorily in 1832, 693; the eminent growers of the carnation named, 432.
- Carrots may be grown in soil from a morass, 56.
- Cassi, a drink, a method of making, 182.
- Castle Semple, its grounds, gardens, &c., noticed, 596.
- Caterpillars, a mode of destroying, 523; caterpillars on gooseberry trees, a mode of checking their ravages, 370, 694.
- Cedar, white. See *Cupressus*.
- Celeriac, turnip-rooted celery, hints on cultivating, 443.
- Cement, Mr. Frost's, how formed, 60.
- Cemetery, the plan of a general one for Edinburgh, sketched, 362.
- Ceratonia Siliqua*, its frequency and uses in Italy, 269.
- Cereus speciosissimus*, magnificent specimen of, at Dropmore, 593; another fine plant of, 80; a new seedling *Cereus*, 361.
- Châra, the circulation of the sap in, 143, 482.
- Chemistry, gardening, technical terms in, require explanation, 735.
- Cherries, Law's method of forcing, 439.
- Chrysanthemum, Chinese, the, a sketch of its history, 692.
- Cider, valuable information on the manufacture of, 383; cider from the French bitter scale apple, 244; the favourite kinds of apple for making cider in Butleigh, and the adjoining parishes, 244; cider made in France, 357.
- Citrus, how can the leaves and fruit of plants of this genus be kept from falling prematurely? 736.
- Cloyne, bishop of, his garden, 475.
- Cock, Siebe's, 370.
- Colosseum, the conservatories and other appendances of, noticed, 594.
- Colvill, Mr. James, his death noticed, 256.
- Cooking alembic, a, for cooking vegetables, 470.
- Corn, a tub for weighing and measuring, 466; Indian corn, Cobbett's, and a Kind grown in Lombardy, 497, 750.
- Cottages, allotments of land to, remarks on, 529; cottages and gardens to them, 96; cottages in Scotland, their condition in 1831, 258, 474; directive hints for the effective cultivation of cottage gardens, 647; industry and independence promoted by cottage gardens, 650.
- Covent-garden market, January 17th, 1832, 127; March 20th, 254; May 21st, 384; July 19th, 504; Sept. 17th, 624; Nov. 22d, 744; weights and measures in Covent-garden market, 574.
- Crème de Moka, a method of making, 182; crème de rose, a method of making, 181.
- Crickets, a means of destroying, 148.
- Cucumber, abundant produce of a plant, 61; on the advantages of M'Phail's pits for early cucumbers, 38; the Russian mode of salting cucumber, 183; a query on growing cucumbers by steam, 612; queries on a species of caterpillar devouring the foliage of cucumbers, 611; Mr. Oliver's hybrid from a cucumber impregnated by the Maltese melon, 611; other cross impregnations, 740.
- Cycas revoluta, female, has flowered in the garden of Count Harrach, at Bruck, on Leithe, and that of Wentworth House, Yorkshire, England, 448.
- Cyclamen persicum, a notice of varieties of, 94.
- Cypress, deciduous, American specimens of, described, 272, 276.
- Cupressus thyoides*, the white cedar, its habits noticed, 447.
- Dielytra, a correction to, 368.
- Diospyros virginiana* 80 ft. high, near Philadelphia, and the Americans distil an excellent brandy from its fruit, 272.
- Dividivi, the *Casalpinia Coriaria*, speculations on its extraordinary usefulness and fitness for appropriation in commerce, 46.
- Dotting with plants, 86.
- Droseras, Mallet on cultivating, 684.
- Dry rot in oak timber, what is the best preventive of? 501.
- Dublin, the mildness of climate at, 364.
- Dumfries stone, the price of garden ornaments made of, 91.
- Earwigs, a means of destroying, 143.
- Education, remarks on, 198.
- Egg plant, the purple-fruited, the only variety eaten abroad, 53.
- Electricity, its agency in vegetation, and a query on, 500, 740.
- Elms, extremely large ones in the United States, 152.
- Emigration, hints to gardeners wishing to emigrate to the United States, 272; works which treat on emigration to America indicated, 464; emigration to Van Diemen's Land, 78.
- Encyclopædia of Gardening*, corrections to the, 83, 482, 483.
- Encyclopædia of Plants*, corrections to the, 85, 244, 368.
- Erânthis hyemalis*, its showiness when in large quantities, 89.
- Erpetion reniformis* nearly hardy, 87.
- Eugenia australis*, its beauty when planted in a bed of soil in a conservatory, 160.
- Eulæxia myrtifolia*, on propagating, 160.
- Evergreens, Stuart's mode of transplanting, 430.
- Fennel is much cultivated at Rome and Naples

- for its roots and leafstalks, which are generally eaten, 267. 271.
- Ferns, a method of raising them from seeds, 451.
- Feuillea cordifolia*, its fruits an antidote to vegetable poisons, 78.
- Ficus stipulata*, effects of culture on, 689.
- Fig, Mr. Pearson's treatment of, criticised, 489; defended, 490. 733.
- Filtering machines, 370.
- Fir, the spruce, seems not to thrive in England, why? 503; fir timber, while full of sap, will resist fire, 488.
- Fleischmann, Johann Martin, a brief biography of, 255.
- Floors and roofs formed of earthen tubes so as to be fire-proof, 60.
- Floral and horticultural society: Carlisle, 626; Chelmsford and Essex, 749; Hull, 122. 635; Lancaster, 630. 751; Rochdale, 115.
- Floricultural and botanical notices of new plants, or of old plants of interest, 12. 224. 345. 454. 596. 721.
- Floriculture, seasonable hints on, 25. 352. See also Plants.
- Florist's flowers, a machine for transferring from one pot to another, 44; an instrument for planting tulips with, 44; a cheap frame and awning for shading beds of, 45; Hurd's plant transplanter, 666.
- Florists' society: Bristol, 633; Cambridge, 746; Chelmsford, 749; Devon and Exeter, 627; Gateshead ancient, 632; Heworth, 749.
- Flower-garden, a design for a, with a list of plants to furnish it, 155; flower-gardens, Mr. Errington's opinions on laying out and managing, 562; various forms of cast and wrought iron stakes for plants in, 557. 554.
- Flower-pots printed on before they are baked, 175.
- Flowers, and the flowers of spring, thoughts on, 25; method of prolonging the flowering season of border flowers, 46.
- Flued walls at Erskine House gardens, Renfrewshire, 670.
- Fly, the black and the green, a means of destroying, 149; flies, a means of destroying, 150.
- Forcing. See Pits. Transportable houses for forcing recommended, 338.
- Forest trees, Mr. Main on pruning, 303; Sinclair on planting, 207. See also Trees.
- France, condition of the labouring classes in the south of, 62; notices relative to France, 356; vegetable productions of the department of L'Orne, 356; a horticultural tour through the Netherlands and part of France, 392.
- Frauds imposed by correspondents, 289.
- Frost, its effects on plants in Prussia in the winter of 1822-3, 340.
- Fruit room, what is the best plan for? 737.
- Fruit trees, the apple bug, *Aphis lanigera*, and lichens on, destroyable by fire, 357; fruit trees by the roadside from Grünberg to Masserwitz, 449. See Canker.
- Fruit wines, modes of making, 186.
- Fruits, the London Horticultural Society's catalogue of, noticed, 212; a press for crushing fruits, 544; a ladder held up by ropes for gathering fruits, 581; a machine for crushing, 542; a press for crushing, 544; remarks on the fruits used in the manufacture of perry and cider, 582.
- Fuchsia globosa* Hort. distinguished and described, 598. 607.
- Fumigator, a detached, figured and described, 354.
- Furnace, Witty's improved, possessed by Mr. Chanter, 26.
- Furze tops, as a manure, 239; Irish furze, its habitat and uses, 369; furze, as a boundary fence to plantations in parks, 678.
- Gardener, house for a, containing five rooms and an office, adapted for being connected with the wall of a kitchen-garden, 551; design for a gardener's house to be connected with the west wall of a kitchen-garden, 659; design for a gardener's house which is to serve also for a watchtower, 600; the gardener's house at Castle Semple wretched, 596; a gardener distinguishing himself, 474; an American lady gardener, 239; gardeners, young, the necessity for them to store their minds with general knowledge as well as with that of gardening, 137; prizes to young gardeners, by horticultural societies, 81; funds to be formed by gardeners for their own benefit, 83; on giving to gardeners the credit due to their employers, 85; advice to gardeners intending to emigrate to the United States of America, 272. 288; trafficking in the situations of gardeners, 499. 730; remarks on the writings of gardeners, 367; remarks on Mr. Mallet's advice to young gardeners, 641; the necessity and advantages of gardeners visiting one another's gardens, 645.
- Gardening, the love for, natural to man, 239; gardening recreations as a substitute for brutalising sports, 140; gardening favourably affected by the law of primogeniture, 275. 277; gardening and nursery business, depressed state of, especially in Scotland, 134; the means of inspiring a taste for gardening among the labouring classes of Scotland, 532; the condition of gardening in Ireland, 474; a catechism on gardening, 373.
- Gardens about Rome and Naples, noticed, 267. 271; garden of the Bishop of Cloyne, 475; gardens near Dublin, 371; descriptive notices of several gardens in England; that of J. A. Beck, Esq. of Esthwaite Lodge, 528; of Sir John Ashley, bart., Everly House, 546; of Sir Edward Antrobus, bart., Amesbury House, 547; of the Earl of Radnor, Longford Castle, 548; the hanging gardens of Limerick, 81; public garden at Magdeburg, a plan and description of, 191. 194; Hogg's florist's garden, 594; Groom's florist's garden, 594; Zoological Society's garden, 594; Surrey Zoological gardens, 594; gardens of the Beulah Spa, 594; proposed botanic garden at Primrose Hill, 594; gardens at Bretton Hall, July 14th, 1832, 607; gardens in the lake district, remarks on, 527; Erskine House gardens in Renfrewshire, 670; town gardens, a work on laying out, 373; suburban gardens, on the management of, 92; design for a flower-garden, for a particular situation near an old mansion, with a list of plants suitable to the plan, 155; garden ornaments in stone, at Dumfries, their price, 91; stakes, iron, for plants in the flower-garden, various forms for, and suggestions on, 555. 557; gardens to cottages, workhouses, prisons, and lunatic asylums, 96. 376; directive hints for the effective cultivation of cottage gardens, 647.
- Gas, ammoniacal, destruction of insects by, 41; the mode of applying it, 656.
- Gates, Telford's iron ones described, 85; designs and details for opening the gates of lodges in the night time, 622.
- Gauntlets for lady gardeners, 37.
- Gentiana acaulis*, on growing and propagating of, 94.
- Georginas, on prolonging the flowering season of, 46; seeds from flowers of one colour produce plants which severally bear flowers of a different colour, 47.
- Germany, notices on, 358.
- Gloriosa superba*, M. Sinning's method of cultivating, 195.
- Goats eligible for introduction into New South Wales and Van Diemen's Land, 452.
- Gooseberries, censurableness of the names given to, 89; a mode of making gooseberries into English champagne wine, 542; a method of making gooseberry wine, 181; a mill for crushing ripe gooseberries, 542; a press for crushing them, 544.
- Gordonia pubescens*, 50 ft. high, near Philadelphia, 272.

- Gourd, various culinary applications of the herbage, flowers, and fruit of, 185, 494; size of the fruit of some kinds of gourd in Italy, 495.
- Grafting, a new mode of, 540.
- Grape vine, hints on propagating it by branches layed into pots, 178; a mode of propagating, 339; a rapid mode of raising excellent plants of the grape vine, 577; a mode of substituting good vines for bad ones with the least possible loss of time, 578; on cleft-grafting the grape vine, 197; on the flowering of the grape vine, 197; grape vines trained on the outside of the alternate sashes of a hot-house produced excellent grapes, 322; the method of training grape vines at Doneraile, 248; grape vines grown on flued walls at Croxdale, 433; the kinds of grape vine best suited to the hot walls of Scotland, 184; can grape vines be forced under the conditions described? 611; the degree of hardihood of grape vines in Italy, 492; the wood of the horsechestnut makes very durable stakes for grape vines, 450; Langford's incomparable grape, preferably increased by buds, 695; Mr. Pillans's expeditious fruiting of grapes in pots, 695; a kind of beetle destructive of grape vines, 737.
- Grapes, how can they be ripened without fires, by the middle of September? 95; grapes ripened in the open air, a mode of preserving for table, during the winter months, 447; a mode of preserving ripe grapes, 339.
- Grass, species of, fitted, to repair lawns, 176; grass land, improved by coverings of loam, 448.
- Groom's florist's garden noticed, 594.
- Grounds, on laying out and planting, 500.
- Grouping of plants, shrubs, and trees, 86.
- Grubworm, a, affects strawberry plants, 92.
- Gymnocladus canadensis, noticed, 85, 272.
- Harbke, plantations made at, 415.
- Hatching chickens in the bark bed of a hot-house, 688.
- Hawthorn, a new variety, with carmine crimson flowers, the *Crataegus Oxycantha rosea superba*, 362, 607; hedge of hawthorn damaged by the parasitic fungus *Aecidium laceratum*, 179; what plant is fitter for the formation of hedges than hawthorn? 738.
- Hayward's remarks on training and physiology, 483, 653.
- Heartsease, the more general cultivation of, recommended, and some interesting varieties of, described, 573; the Lady Bath heartsease noticed, 94.
- Heaths, Cape, M'Nab's work on cultivating them, 210; Rutgers's mode of propagating them expeditiously; 681; query on preserving Cape heaths from mildew, 736.
- Heating of air and water by lenses, M. Gaucen's mode of, noticed, 497, 6-9; conservatory and bath heated from one boiler, 90; wood preferable to coal for heating, 433.
- Heating. See Hothouses.
- Henderson, Mr. Walter, a brief biography of, 256.
- Herbarium, by Mr. Toward, 367.
- Hibiscus attenuatus of Bosse, the character and the mode of cultivating, 447; *H. fugax Mart.* noticed, 338.
- Hiuge, Howden's, for causing gates to close, 38.
- Hobson, Mr., deceased, his book on mosses, 94.
- Hoe, engraving and description of a newly invented, 558; Lord Vernon's tillage hoe, 689.
- Hollows and knolls, remarks on planting, 486.
- Hops, a mode of supporting them in the Vosges, 65; hop tops useful as a culinary vegetable, 184.
- Horseradish, a Danish and German mode of cultivating, 436.
- Horticultural notes on a journey from Rome to Naples, 265. See also Tour.
- Horticultural societies (provincial) of England and Wales: Abergavenny and Crickhowei, 653; Beccles, 624; Bedfordshire, 115, 745; Bristol and Chilton, 119, 653; Bury St. Edmunds, 119; Cambridgeshire, 626, 745; Cirencester, 629; Cornwall, 746; Devon and Cornwall, 627; North Devon, 748; Diss, 630; Evesham, 121; Glamorgan and Monmouth, 252, 635; Gloucester, 629; Hereford, 629, 749; Ipswich, 120, 634; Lancashire, 115; Lancaster, 731; Manchester, 115; Norfolk and Norwich, 620; Northamptonshire, 117, 634; Northumberland, 118; Oxford, 118, 632; Ross, 629, 749; Somersetshire, 118; Suffolk, 119; Taunton, 633; Taunton and West Somerset, 119; Whitehaven, 627, 747; Wilts and general, 634; Worcestershire, 121, 635; Yorkshire, 122.
- Horticultural societies in Ireland. Horticultural society of Ireland, 639; of Belfast, 124, 252, 610.
- Horticultural Society of London and its garden, Nov. 1st, 1831, to Jan. 3d, 1832, 125; from Jan. 17th to March 6th, 252; from March 30th to May 15th, 378; from June 5th to July 17th, 305; from July 17th to August 7th, 614; from Oct. 2d to Nov. 6th, 742. A report on the state of the garden from inspection, 471.
- Horticultural society of Prussia, 359.
- Horticultural societies of Scotland. Aberdeenshire, 122, 636; Ayrshire, 122; Caedonian, 122, 252, 635; Cupar, 637; Dundee, 123; East Lothian, 123, 636; Glasgow, 637; Mid Lothian, 123; North British Professional Gardeners', 123, 637; Rentrewhire, West, 637; Stirling, 114, 124, 638.
- Horticultural societies, the formation of, in the suburbs of London, suggested, 82; horticultural societies should offer prizes to young gardeners for the objects specified, 82.
- Horticultural societies. See Botanical and Horticultural society, Floral and Horticultural society, and Florists' society.
- Hortus Britannicus*, additions to the Additional Supplement of, 604-607.
- Hot-houses, remarks on the slope of the roof of, 191; the mode, at Vienna, of constructing double-roofed hot-houses, 535; the state of the practice of constructing hot-houses in Scotland, 521; an improved mode of heating of hot-houses, 452; different modes of heating hot houses, 469; hatching chickens in the bark bed of a hot-house, 688; Hay's method of heating by steam, 330, 730.
- Hot water, as a means of heating, 221; Mr. Perkins's mode of circulating in hermetically sealed tubes of small diameter for heating hot-houses, &c., 236, 292-297; Weeks's new apparatus for heating by, 594; hot water apparatus in a pinery at the Earl of Egremont's, Petworth, Sussex, the details of its action, 147.
- House, glazed, one adapted for the culture of peach trees, grape vines, and ornamental plants, 321; transportable houses for forcing recommended, 338; gardener's house, containing five rooms and an office; design for, 551; other designs for houses for gardeners, 659, 660.
- Howden's, Mr., reply to Messrs. Murphy's and Hayeroff's criticisms on his remarks on Irish cottages and labourers, 369; Mr. Howden's reply to Mr. Thomas Small's attack on him, 248.
- Hybrid plants, the sterility of, instanced, 560; hybrid calcceolarias, 48; hybrid melons, 52, hybrid canellias named, 212; hybrid *Cereus*, 361; hybrid *Digitalis*, Henslow's examination of a, 269; hybrids obtained between plants of melon and of cucumber, 611; hybrid laburnum, 473; hybrid plum raised by Mr. Knight, 433; hybrid poppy, 355; hybrid strawberry, 593.
- Insects, various, recipes for destroying, 148; annular pan as a defence against insects, 37; destruction of insects by ammoniacal gas, 41; insects infesting cucumbers, 611; insects prevented ascending the stems of trees, 340; insects are enshrined in the leaves which remain through the winter on trees habitually deciduous in autumn, 498.

- Ipomœa Batatas* Poir., the batata, the results of its cultivation in Italy, 495; thoughts on its success in Britain, 613.
- Ipomœa purpurea* and *Calystœgia sepium*, the corollas of, differ in the mode of withering, 736.
- Ireland, notices relative to, 364; rural improvement in, 365; improvement of the condition of the labouring class in, 365; Lambert's rural affairs of, and Elles's remarks on them, 215; the condition of gardening in Ireland, 248, 474; a list of green-house and hot-house plants which are comparatively hardy at Drumcondra, near Dublin, 568; gardens in Ireland noticed, 81, 83, 371, 482.
- Iris, the peacock, the exquisite beauty of its blossoms, 469; *Iris tuberosa*, a native of Britain, and a mode of cultivating it productive of blossoms, 235.
- Irish cottages, &c., 85, 369; Irish labourers 369; a certain Irish mansion, 372; Irish pearl moss, 94.
- Italy, remarks on the gardening of, 69; climate of Italy, in relation to orange trees, lemon trees, grape vines, &c., 492; certain kinds of melon grown in Italy, 613; Italian gardening and landscape reported on, 267.
- Jenkins, Mr., nurseryman, his death recorded, 584.
- Kensington Gardens reported on, 473.
- Kentucky coffee tree noticed, 85, 272.
- Kew, the pleasure-ground at, 473.
- Kilkenny, a notice of the climate of, orchards of, and the kinds of apple and pear which thrive in the orchards of, 165.
- Kino, gum, noticed, 77.
- Kirschwässer, a method of making, 182.
- Knolls and hollows, remarks on planting, 486.
- Labourers and their condition, 200; instances of letting land to labourers in Cambridgeshire and Suffolk, 98; the condition of labourers in a village in Nottinghamshire, 529; strictures on the kind of labourers to whom land for gardens is most eligible, 529; the good and evil of letting land to labourers, 377; of the improvement of the condition of labourers in Ireland, 365; the means of inspiring a taste for gardening among the labouring classes of Scotland, 532; condition of the labouring classes in the south of France, 62.
- Laburnum, a hybrid, with lilac flowers, 473.
- Lachenalias, hints on the culture of, 234.
- Ladder with appurtenances for gathering apples, &c. from trees, without allowing the ladder to rest on the tree, 581.
- Larch, the wood of, full of sap, will resist fire, 488; facts on the timber of larch, 93.
- Lathyrus grandiflorus*, seeds from, obtained by artificial impregnation, and other remarks on, 50, 733.
- Lawns, fit species of grass for repairing, 176.
- Leaves persistent through the winter on trees, habitually deciduous in autumn, enshrine insects, 498.
- Lectures on botany applied to horticulture, by Professor Lindley, 580, 507, 615.
- Leguminous plants of Australia and the Cape of Good Hope, Bowie's hints on cultivating them, 5.
- Lemon and orange trees, as cultivated in Italy and at Naples, 269, 271; their degree of hardiness in Italy, 492.
- Lenses, M. Gaucon's mode of heating air or water by, 497; Mr. Mallet's remarks on, 609.
- Lettuce, cabbage, Mr. Rutger's method of forcing, at Shortgrove, Essex, 172.
- Lichens on fruit trees destroyed by fire, 357, 358.
- Lilium Martagon*, queries on, 501.
- Lime, chloride of, in agriculture, 445.
- Limekilns, and burning of lime, 741.
- Limerick, hanging gardens, 81.
- Lindley's (Professor) publications, a retrospective criticism on, 728.
- Liqueurs, various, modes of making, 180.
- Lisieux, Normandy, an account of the subscription garden at, 66.
- Lock, wooden, in use in Lapland, 468.
- London, the plants which thrive in the smoky atmosphere of, 243.
- Machine, Budding's mowing, figured and described, 34; machine for hewing stone by steam, 92; machine for preparing flax and hemp by a new and improved process, for manufacturing into canvass, cordage, &c., 96; filtering machine, 370.
- M'Naughton, Mr. Archibald, a notice of his death, 384.
- Magdeburgh public garden described and illustrated by a plan, 191.
- Magnolias, their great size in America, 272.
- Maize in North America, 75; a hardy variety of, 693; culture of, in England, 750.
- Mangles, portable, spoken of, 354.
- Mangold wurzel, the mode of brewing ale from, 697.
- Manure, useful to fruit trees when applied in moderation, 446; furze tops used as a manure, 239; tar used as a manure, 239.
- Maroschino, a kind of cherry brandy, is made from the fruit of the *Prunus bis-florens*, 188.
- Meliánthus mājor is almost hardy, 94.
- Melons, two sorts described, 191; Mr. Knight on the cultivation of the Persian varieties of melon, 435; M. Ebers's mode of cultivating melons, 450; Mr. Smith's mode of cultivating melon plants at Cunnoghie, 329; certain kind of melon grown in Italy, 613; Mr. Oliver's hybrid, obtained from a cucumber impregnated by the Maltese melon, 611; M. Sageret's experience on hybrid melons, 741; hardihood of hybrid kinds of melons, 52; Jacquin's work on the melon, 453.
- Mice and rats, a mode of poisoning, 239.
- Mignonette, what species is that which Jesse calls the tree? 374.
- Mildew, a mode of preventing the recurrence of, 40.
- Moles, an efficient trap for catching, 298; mole trap, a French one figured and described, 36; a kind invented by A. F., figured and described, 299.
- Mowing. See Machine.
- Mulberry tree, the, as cultivated in Italy, to sustain silkworms for supplying silk, 496.
- Munich, notices on gardening at, 67, 358.
- Mushrooms, Mr. Callow's, noticed, 244; his work on producing, 214; Elles's hints on producing, 214; the culture of mushrooms in melon beds, 312.
- Nails, a mode of cleaning wall nails, 40.
- Naples, notes on the gardens of, 271.
- Narcissinean plants, the names of some rarer kinds, and hints on cultivating them, 50.
- Nectarine and peach trees, Seymour's system of training, 51; nectarine trees distinguishable from peach trees by a difference in their two germens, 409; a mode of destroying the aphid on nectarine trees, 580; Hayward's mode of training peach and nectarine trees, 653.
- Neill's, Patrick, Esq. garden at Canonmills noticed, 364.
- Nelumbiums, on the culture of, 157; M. Lübeck's mode of cultivating *Nelumbium speciosum*, 197.
- Nerine humilis* and *undulata*, nearly hardy, 81.
- Netherlands and part of France, a horticultural tour through, 392.
- Nonpareil, a drink, a method of making, 182.
- Normandy, an account of the subscription garden at Lisieux in, 66; some account of Lower Normandy, 63.
- Numbering stick, on an improved application of the notch principle, 32.
- Nurseries in the United States described, 272—289; nurseries in the Netherlands and part of the south of France, 392.
- Nurseries, metropolitan, 101; Brown's Bedford nursery, Hampstead Road, 102; the Maryland Point, Stratford, Essex, 102; Epsom Nursery, new or rare plants which have flowered in, 102; the Mile-end nursery, 249.

- Nurseries, English provincial, information on, solicited, 104; an account of the Bache Pool nursery, near Chester, Messrs. F. and J. Dickson's, 105; of Messrs. Conolly and Sons' nursery, at Lancaster, 108; of Messrs. Skirving and Co.'s Walton nursery, near Liverpool, 109; of Messrs. John Pope and Sons' Handsworth nursery, near Birmingham, 110; Messrs. Rednall and Bircham's Holton nursery, near Halesworth, Suffolk, 251; Cameron's nursery, Uckfield, Sussex, 741; Carlisle nursery, Messrs. William and Thomas Lutton, 741; Keswick nursery, Mr. Kerr, 742.
- Nurseries, Scottish provincial, of Messrs. Smith and Sons, at Ayr, Monkwood, and Colroy, 113; of Messrs. W. Drummond and Sons, at Stirling, 113; Mr. Goldie's, at Wrightfield, near Ayr, 474.
- Nursery and gardening business, depressed state of, more especially in Scotland, 134.
- Oak, on the pruning of the, 243; oak timber, what are best means of preventing the dry rot in? 501. See *Quercus*.
- Ohio, the state of, remarks on the indigenous flowers and fruits of, 574.
- Olive tree, Italian means of propagating it, 63.
- Onions, store, a mode of preventing their sprouting or germinating during the winter, 55; on the transplanting of onions, 180.
- Orange trees, their degree of hardihood in Italy, 492; oranges and lemons, as cultivated in Italy, and at Naples, 269, 271.
- Orchideous epiphytes, on the propagation of, 88; Mr. Lindley's directions for cultivating, 318; his directions for the manner of collecting and preserving on board a ship, 603.
- Oxalis rosea* Jac. (*floribunda* Lindl.), a mode of cultivating, 572; *O. D'ŕoyi* noticed, 691.
- Pœonia Moultan*, a magnificent plant of, 473; the double-flowered variety of *P. officinalis* produces seeds, 243.
- Pain's Hill, near Cobham, Surrey, noticed, 361.
- Palms, Choco, noticed, 79.
- Pilo de vaco, seeds of, 361.
- Paris, the condition of the markets of, in relation to gardening on Dec. 20th, 1831, 65.
- Parmentier's garden, near Brooklyn, North America, described, 71.
- Pea, Bishop's early dwarf, its merits compared in detail with the merits of the early frame, Knight's dwarf marrow, and the Spanish dwarf, 584; Mr. Knight's mode of obtaining very early crops of green peas, 434; the white flowered everlasting pea, queries and information on, 610.
- Peach trees, Hayward's system of training, 484, 653; Seymour's system of training, 51; a preventive of the curling up and dropping off of the leaves of peach trees, 340; a mode of destroying the *Aphis* on peach trees, 580; the Myrobalan plum tree an eligible stock for peach trees, 340; peach trees distinguishable from nectarine trees, by a difference in their two germs, 469.
- Pear, a description and outline figure of the Petre pear in Carr's nursery, Philadelphia, 587; seedling kinds of pear raised by Mr. Knight, 439; remarks on the relative value for perry of the Barland and other kinds of pear, 582; monstrous pears noticed, 697.
- Pear trees, a mode of training pear trees described and figured, 539; pear trees trained to a wall built to an angle of ten degrees to the earth's surface, produced an abundance of fine fruit, 183; a fungose disease on the leaves and fruit of the pear trees at Buscot park gardens, 738.
- Pearl moss, Irish, 94.
- Pelargonium zonale* var. *Blücheri*, a fine plant of, noticed, 80; Mr. Weltje's collection of *pelargoniums*, 473.
- Pelargoniums*, a method of cultivating them, practised by Mr. Appleby, 161; another mode practised by Mr. Robert Elliot, 162; on prolonging the flowering season of *pelargoniums* in beds in the open air, 46.
- Pepper, black, a history of, 228.
- Perry, valuable information of the qualities and manufacture of, 582.
- Phœcoma proflifera*, on propagating, 160.
- Philadelphia, nursery gardens and state of horticulture at, 272.
- Philipsburg in Pennsylvania, North America, its capacities as to soil and climate described, 73.
- Physiology, vegetable, questions in, 652, 653.
- Pimlico palace and gardens noticed, 472.
- Pine-apple, Mr. Muuro's enumeration of varieties of, with hints on cultivating them, 177. Mr. Smith's mode of cultivating pine-apple plants at Cumquoehie, 328; the mode and results of cultivating plants of the pine-apple out of pots, 576; a means of destroying the scale on plants of the pine apple, 149; pine-apples are plentiful and cheap at New York, 360; for the reason, see p 275; pine apples as cultivated in the stoves of Italy, 494; in the open ground of Italy, 493.
- Pine timber, while full of sap, will resist fire, 488; an account of the common Scotch and Highland pines as found in Scotland, 10; enquiries for farther information on them, 489; pine of very large size in the United States, 154; *Pinus Strobus*, the Weymouth pine, its habits in Prussia, 447.
- Pinguiculas, Mallet on cultivating, 684.
- Pita de Guataca supplies a fibre valuable for cordage, &c., 240, 367; pita de Tolu, 242.
- Pits planned and constructed by Mr. Hay, for the securing a steady and uniform bottom heat, 330; pit described, and the steam apparatus by which it is heated, as both used at Cumquoehie, by Mr. Smith, in the culture of pine apple and melon plants, 328; the advantages of M'Phail's pits, 38.
- Plantations, thinning and pruning of, 373; plantations made at Harbke, 445.
- Planting and laying out grounds, on, 300; planting knolls in preference to hollows, 486; planting ministers to wealth, 239.
- Plants, new, or interesting old ones, noticed, 12, 224, 345, 454, 596, 721; plants which thrive in the smoky atmosphere of the London neighbourhood, 243; a plan for removing a potted plant from one pot to another without injury, or breaking the ball of earth, 43; plants worth importing for cultivation in Britain, 306; on the sap vessels or circulating system of plants, 142.
- Pleasure-grounds, defects in, and the means to avoid these defects, 151, 677.
- Plum, a new variety of, raised by Mr. Knight, 433; a mode of preserving ripe plums, 359; the Myrobalan plum tree, a fit stock for plum tree, peach tree, and nectarine tree, 340.
- Polýgala cordifolia*, on propagating, 160.
- Polýgala vulgaris* of different colours, 93, 503.
- Poplar, Lombardy, facts in the history of, 92.
- Poppy, hybrid, between *Papaver nudicaule*, and *P. album*, 355.
- Posts or pales, a mode of detecting the stealers of, 42.
- Potato, a means of preventing the curl in, 180; a method of obtaining very early crops of new potatoes, 315; a mode of producing young potatoes for the table during winter, in the open air, 54; Mr. Knight's remarks on the fitness and value of potatoes as food for animals and man, and his description of his method of speedily ascertaining the qualities of seedling potatoes, 456; frozen potatoes not rendered eatable by being thawed in the dark as apples are, 356; a "cooking alembic" for cooking potatoes and other vegetables, 470; a mode of obtaining two crops of the ash-leaved kidney, in one year, off the same ground, 686; potato, sweet, see *Ipomœa Batatas*.
- Press for crushing fruit, 544.
- Primrose Hill botanic garden, 594.
- Prisons and gardens to them, 98.

- Protecting tenderish shrubs from severe frosts, a mode of, 189.
- Pruning of forest trees, Mr. Main on, 303; Mr. Howden's opinions on pruning large trees, 559; pruning and thinning of plantation, 373; a pair of shears for summer pruning, 668.
- Prussia, state of gardening in, 187, 442; horticultural society of Prussia, 359.
- Quercus*, the species of, named, which are desirable for the size and form and colour of their leaves, and for useful timber, 195; *Quercus coccinea* and *rubra*, notices on, 444; a variety, with narrow and occasionally entire leaves, of *Quercus Robur*, 740.
- Rafflesia Arnoldii* Brown and *R. Pátma Blume* contrasted, 708.
- Railroads in North America, 72; railway, one suggested for conveying ships overland, 354.
- Ranunculus*, the Asiatic, remarks on cultivating the, 570; Mr. George Thurtell's show of *ranunculuses* briefly noticed, 631.
- Ranunculus parnassifolius*, a mode of cultivating, 572.
- Rats and mice, a mode of poisoning, 239.
- Regent's Park, botanical and ornamental garden in, 470.
- Residences: choice of situation for a residence, 372; a work on laying out villa and other small residences, 373; in the formation of a residence, should the architect or landscape-gardener be first employed? 673.
- Rhëum austracum*, its esculent properties, 693.
- Rhododendron*, a method of protecting the tenderish kinds of, from severe frosts, 189.
- Ribes sanguineum*, a very fine plant of, 635; the *Ribes speciosum* described, 455.
- Rice, Canadian, *Zizania aquatica*, a mode of cultivating, 190.
- Riga, a short account of the gardens at, 197.
- Rio de Janeiro, remarks on the vegetation of, 188.
- Roads in Van Diemen's Land, 78.
- Robinia Pseud-Acacia* grows any where, and its wood applicable to various economical purposes, 191.
- Rocks, an apparatus for rending by gunpowder, 591.
- Rods, parallel, for graduating beds, 669.
- Rome, notes on the gardens of, 267.
- Roofs and floors formed of earthen tubes, and thereby fire-proof, 60.
- Root, tap, of trees, effects of shortening, 339.
- Rosa turbinata*, the Frankfort rose, is very free of growth and blossom, 189; rose bushes, and other shrubs, a mode of protecting them from severe frosts, 189; Lawrence's stakes for, and mode of training standard rose trees, 679.
- Salisbòria adiantifolia* ingraftable, 445.
- Salm-Dyck, a notice of the botanic garden of the Prince de, 446.
- Salpiglossis*, sportiveness in the species of, 47.
- Salt as a destroyer of weeds, 372; salt as a manure, 373; salt invigorates leeks, 373.
- Sands, shifting, on the culture of, 44.
- Sap vessels, or the circulating system of plants, facts and arguments on the, 142; the circulation of the sap in *Châra*, 482; a question on the organisable property of sap, 652.
- Scarlet runner bean, a perennial, 53.
- Scotland, notices relative to, 474; agriculture in the West of Scotland, 513; field and roadside hedges in, 514; plantations in, 515; edgings of walks in, 518; kitchen-gardens in, 519; grass lawns in, 519; Menteath's remarks on inspiring a taste for gardening among the labouring classes of Scotland, 532; a notice of Auchincruive, 595; of Castle Sempie, 596; notices on the towns and villages of Scotland, 385; their waterworks, waterclosets, sewerage, and churchyards, 389; the plan of a general cemetery for Edinburgh described, 362; the thistle of Scotland, 355; flued walls and kitchen-garden at Erskine House, Renfrewshire, 670; agricultural and horticultural exhibition at Stirling, 113.
- Seeds, Mr. Murray on the germination and subsequent vegetation of, 326; the germination of seeds is expedited by applying to them malic acid, or the rotten pulp of apples, 445; M. Otto's remarks on the germination of seeds, 196; hints on raising seeds, 5, 25; seeds of annual plants, an improved mode of raising, 434; the mode and results of sowing seeds of annual flowering plants in autumn, 570; seeds remain for many years in the earth, and vegetate on meeting with air and light, 359, 374; on the preservation of seeds, 358.
- Sewerage, suggestions on, 387.
- Shalder's fountain pump, 729.
- Shears for summer pruning, 668.
- Sheds for breakers of stone suggested, 238.
- Shennan, William Johnstone, a brief biography of, 751.
- Shrubberies, defects in the forms of, and means of avoiding such defects, 152.
- Silk, and Silkworm. See Mulberry.
- Slugs and snails, Martin's mode of decoying, 149, 370.
- Snails, Mr. Martin's mode of decoying, 149, 370; Mr. Corbett's mode of destroying, 434.
- Spider, red, remarks on, 499; counter remarks, 735.
- Stakes, cast-iron flower-stakes, and some small wrought-iron stakes for peas or annual plants, 554, 557; stakes for standard rose trees, 679.
- Starkey, Mrs., her floral decoration of the village of Bowness, 527.
- Steam from dung linings, a mode of preventing its injuring plants in frames, 314; the steam apparatus applied by Mr. Smith to his pits at Cunnoquich, described, 328; steam carriages, their applicability to the improvement of land, 30; Hay's method of heating by steam, 330, 730.
- Still, a figure and description of one used in making liqueurs from fruits, 183.
- Stirling agricultural and horticultural exhibition, 113.
- Stone, artificial, Austin's works in, 237.
- Stonebreakers, sheds for, suggested, 238.
- Straps, leathern bearing, and wallet, 86.
- Strawberry, tiles made to accelerate the ripening of strawberries, and to keep the berries clean, 435; a new kind of strawberry raised by Mr. Darke, at Bordesley, near Birmingham, 593; a grub-worm infests plants of the strawberry, 92.
- Stuttgart, a notice on, 358.
- Sublime de variété, a drink, a method of making, 183.
- Suburban gardens, on the management of, 92.
- Succulent plants, the structure and physiology of, noticed, 234; Mr. Hitcher's collection of succulent plants, noticed, 244.
- Sugar, American, obtained from the sap of species of maple, 502.
- Surrey Zoological Gardens, noticed, 594.
- Sutton Wash embankment, 589.
- Swan River settlement, some account of, 78.
- Sweet's *Flower-Garden*, controversy on plants not hardy being figured and described in it, 87, 368.
- Sydney, some notice of its condition, 78.
- Syringes figured and described, Warner's, 353; Siebe's, 354.
- Tallies, brick ones, 33; a numbering-stick on an improved application of the notch principle, 32; brick tallies, printed upon before they are baked, 175; directions for preparing Murray's tallies, 374.
- Tar used as manure, 239.
- Tea plant, contributions to the history of, 89, 490.
- Téctona grândis*, on the germination of the seeds of, 191.
- Telescope, Varley's graphic, noticed, 238.
- Temperance societies, remarks on, 43.
- Temperature. See Thermometer.
- Temple Newsham, briefly noticed, 361.
- Thames. See Water.

- Thermometer, a sentinel or regulating one, invented by Mr. Lindley, 30; a self-acting apparatus for regulating temperature, 30; thermometer for steam-pits and hot-beds, figured and described, 337.
- Thistle, the, of Scotland, 355.
- Thomson, Mr. Archibald, nurseryman, a brief biography of, 256.
- Tivoli garden at Vienna described, 66.
- Tobacco, a mode of growing and curing for smoking plants with, 42; queries on growing, preparing, and applying tobacco, 499; remarks on cultivating and curing tobacco, 491; on washing tobacco before burning it, 695.
- Tomato, a method of cultivating the, to make sure of ripening its fruit without artificial heat, 174; other remarks on the culture and keeping of tomatoes, 53.
- Tour, horticultural, the Conductor's, in Scotland, from Dumfries, by Kirkecudbright, Ayr, and Greenock, to Paisley, l. 129, 257, 385, 513; Rivers's, through the Netherlands and part of France, 392; Mallet's, on the Continent, 521; Spence's horticultural notes on a journey from Rome to Naples, 266.
- Training: Hayward's remarks on training and physiology, 483, 653; Seymour's method of training peach and nectarine trees, 51; Hayward's method, 483, 653; a mode of training pear trees described, 539.
- Transplanting of large trees, Mr. Howden's remarks on the, 559; Stuart's mode of transplanting deciduous trees and evergreens, 439; a mode of transferring a potted plant from one pot to another without injuring the plant or breaking its ball of earth, 43; Hurdis's plant transplanter, 666; Jesse's apparatus for transplanting trees and large shrubs, 731.
- Travelling, the equipment fittest for, on the continent of Europe, 522.
- Trevirana coccolinea, a mode of cultivating, 491.
- Tree guard, figured and described, 154.
- Trees newly transplanted supported by pegging down their roots, 86; effects of shortening the tap root of trees, 339; Stuart's mode of transplanting deciduous trees and evergreens, 439; Mr. Howden's remarks on transplanting and pruning large trees, 559; dimensions and names of very large trees in the United States, 152; kinds of tree worth imparting for cultivation in Britain, 366; shears for the summer pruning of trees, 668.
- Triumphal arch at the end of Piccadilly, 472.
- Truffle, *Tuber cibarium*, its habits in West Prussia, 443.
- Tub for measuring and weighing corn, 466.
- Tulips, an instrument for planting the bulbs of, with, 45; a cheap awning and frame for supporting the awning for beds of, 45.
- Turnip, a superior variety of the Swedish, figured and described, 57; on the disease in turnips called anbury, or fingers and toes, and means of remedying it, 323, 498.
- Typha, its seed-down proposed for stuffing for beds, 697.
- Vandes, Comtesse de, the death of, recorded, 256; a walk round the garden of the late, 476; a brief notice of the garden, 361; and of the results of the sale of plants of, 593.
- Van Diemen's Land, notices on the condition and capacities of that country, 77; introduction of goats into, 432.
- Vegetables, a "cooking alembic" for the cooking of, 470; the Russian mode of preserving culinary vegetables through the winter, 184.
- Venice, state of the horticulture of, 448.
- Vermin. See Mole, and Insects, and Crickets.
- Versailles, a notice of the public garden at, 525.
- Vinery, can one be forced under the conditions stated? 611.
- Walks, remarks on the edges of, 86.
- Wallet, leathern and bearing straps, 86, 370.
- Walls built to an angle of 10 degrees to the earth's horizon render apple and pear trees trained to them frugiferous, 183; fued walls in the gardens at Erskine House, Renfrewshire, 670.
- Washing-machine for families, noticed, 354.
- Wasps, a means of destroying, 150.
- Water. See Hot water.
- Water, on preserving the purity of the water of the Thames, 464; a plan for filtering the water of the Thames, 465; water, heated by the sun's rays passed through lenses, 609.
- Waterclosets, public, suggestions on, and forms for, 389.
- Waterworks, Shaw's, at Greenock, 385.
- Wells, fountain, their useful agency, and queries on the causes of their fountain property, 500.
- Wellsinkers, an apparatus for, to explode their blasts, when sinking wells in rocks, 590.
- West, Counsellor, his garden near Dublin, noticed, 83, 482.
- Wheelbarrow, a Norman, figured and described, 238.
- Whin (*Ulex europæa*), the origin of the word whinstone, 369. See Furze.
- Wine, English champagne, a mode of making, 541; wines from fruit, modes of making, 187.
- Wireworm, a query on, 499.
- Wood, the kinds of, which will last longest in the ground without rotting, 196; the properties of various kinds of wood used for fuel, 488.
- Woodlouse, the, is exceedingly destructive to all stove orchideous plants, 603; a means of destroying, 148.
- Workhouses, and gardens to them, 96.
- Yucca gloriosa*, the flowering of, 80, 745.
- Zinc, rolled in plants, a substitute for lead and slates, 60.
- Zizania aquatica*, a mode of cultivating, 190.
- Zoological Society's gardens noticed, 594.

END OF THE EIGHTH VOLUME.

LONDON :

Printed by A. & R. Spottiswoode,
New-Street-Square.



